



US00D894545S

(12) **United States Design Patent**
Sherman

(10) **Patent No.:** **US D894,545 S**

(45) **Date of Patent:** **** Sep. 1, 2020**

(54) **SANDAL STRAPS**

(71) Applicant: **Lowell A. Sherman**, Auburndale, MA
(US)

(72) Inventor: **Lowell A. Sherman**, Auburndale, MA
(US)

(**) Term: **15 Years**

(21) Appl. No.: **29/683,012**

(22) Filed: **Mar. 10, 2019**

(51) **LOC (12) Cl.** **02-04**

(52) **U.S. Cl.**
USPC **D2/917**

(58) **Field of Classification Search**
USPC D2/896-900, 903, 916-925, 943, 946,
D2/969, 971, 976
CPC A43B 3/12; A43B 3/122-128; A43B 3/10
See application file for complete search history.

(56) **References Cited**

U.S. PATENT DOCUMENTS

D217,217 S * 4/1970 Evins D2/918
D371,897 S * 7/1996 Bishop D2/916

D461,042 S * 8/2002 Urie D2/916
D547,045 S * 7/2007 Belley D2/916
D560,344 S * 1/2008 Belley D2/916
D561,457 S * 2/2008 Andersen D2/916
D774,289 S * 12/2016 Comeau D2/916

* cited by examiner

Primary Examiner — Rashida C. Walshon

(57) **CLAIM**

The ornamental design for sandal straps, as shown and described.

DESCRIPTION

FIG. 1 is a side perspective view of a sandal straps, embodying the design;
FIG. 2 is a first side plan view of the sandal straps thereof;
FIG. 3 is a second side plan view of the sandal straps thereof;
FIG. 4 is a rear plan view of the sandal straps thereof;
FIG. 5 is a front plan view of the sandal straps thereof; and,
FIG. 6 is a top elevation view of the sandal straps thereof.
The broken lines shown are included for the purpose of illustrating the unclaimed portions of the article and form no part of the claimed design.

1 Claim, 6 Drawing Sheets

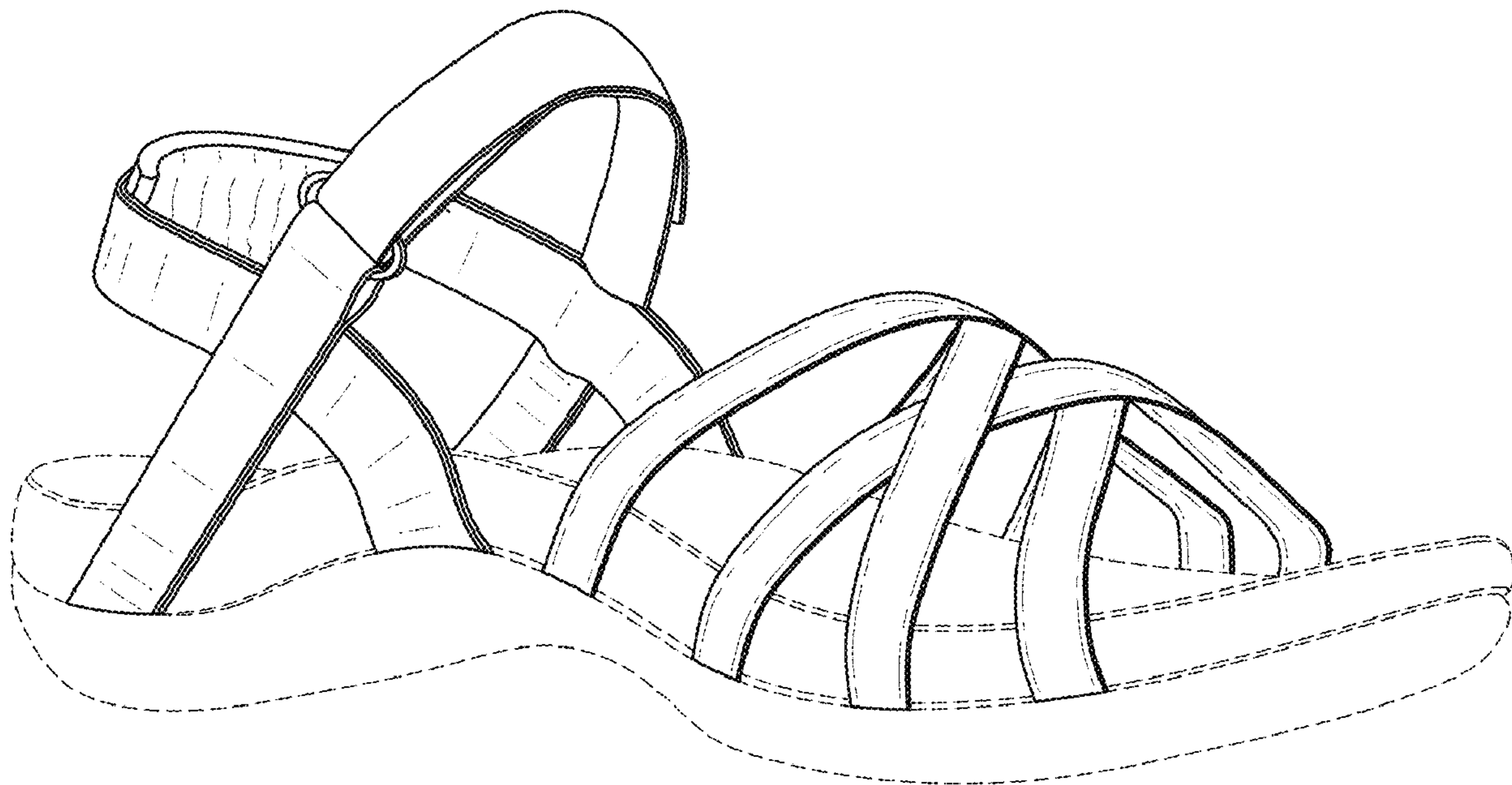

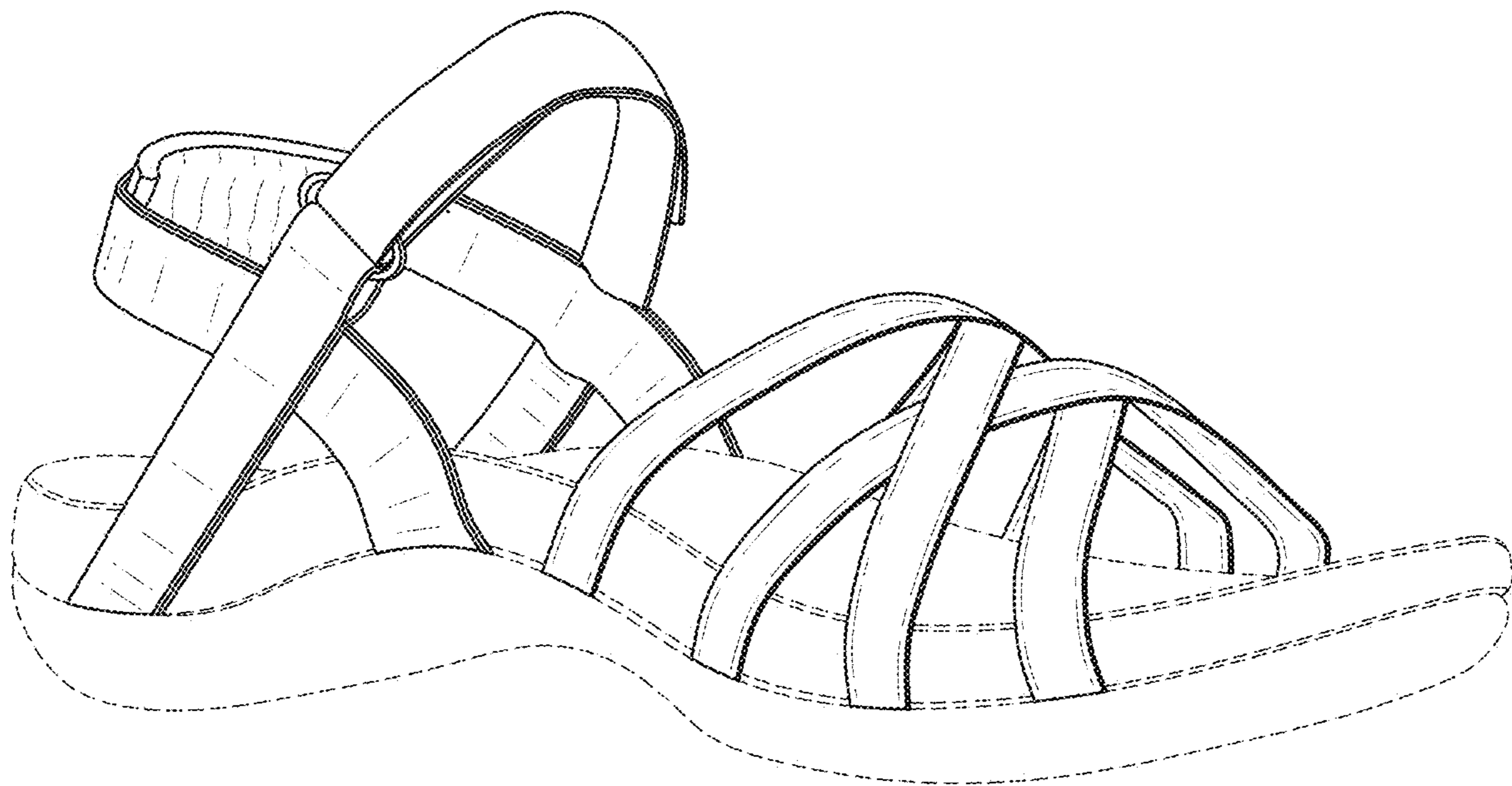

FIG. 1

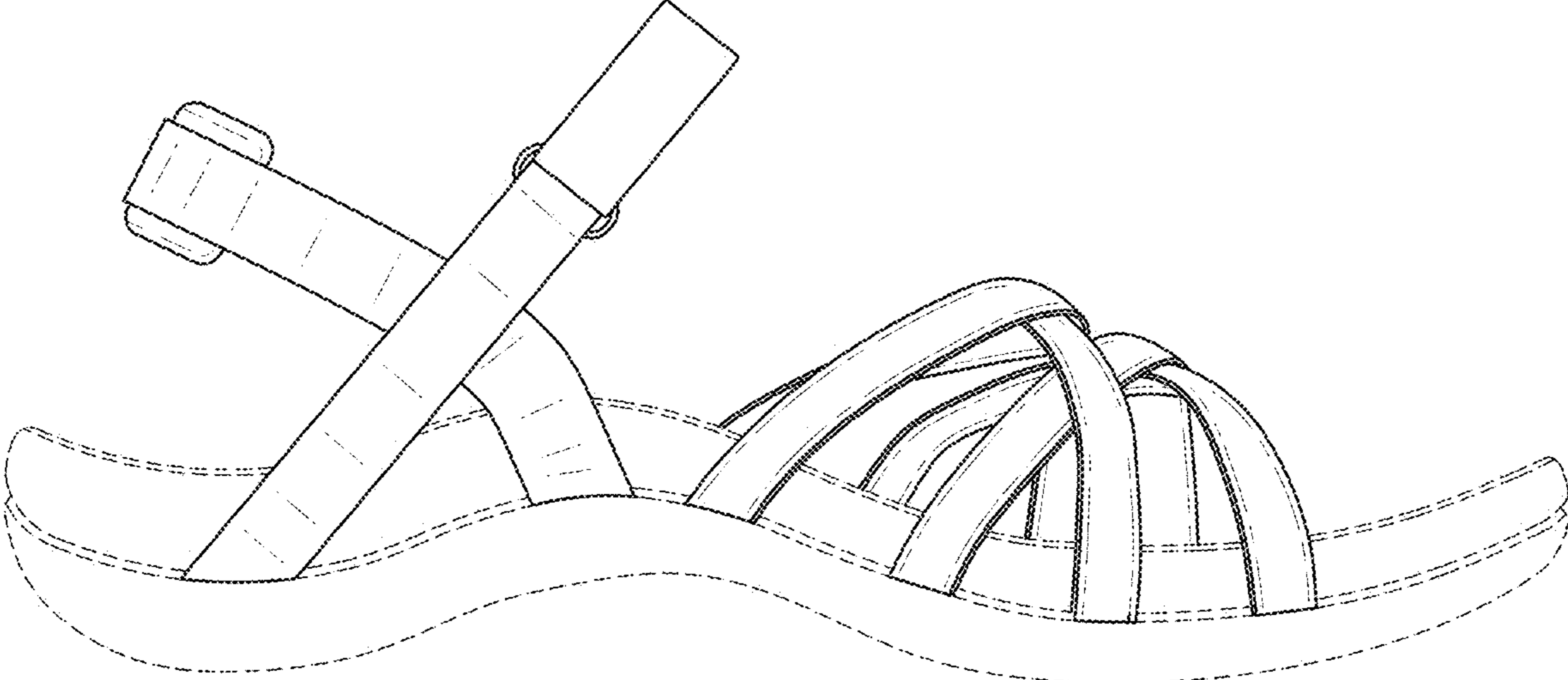

FIG. 2

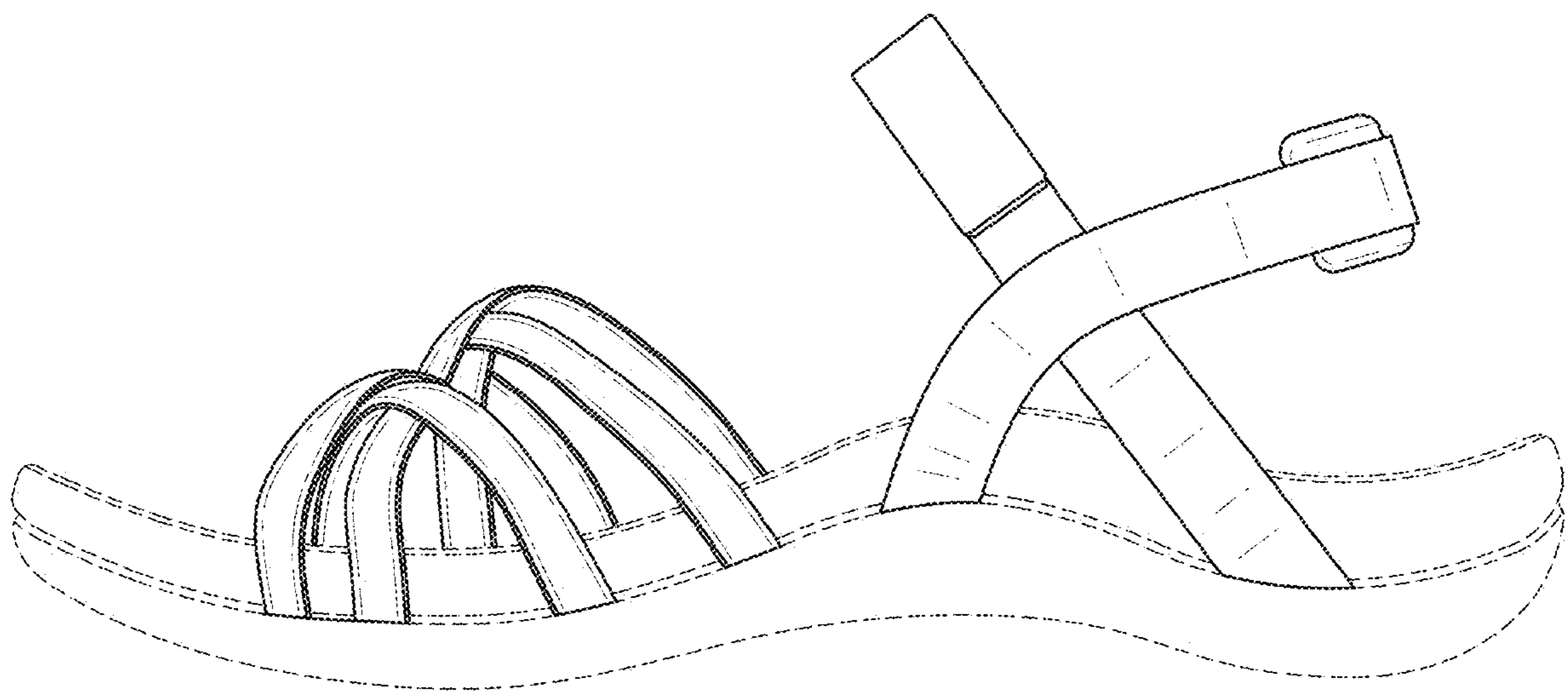

FIG. 3

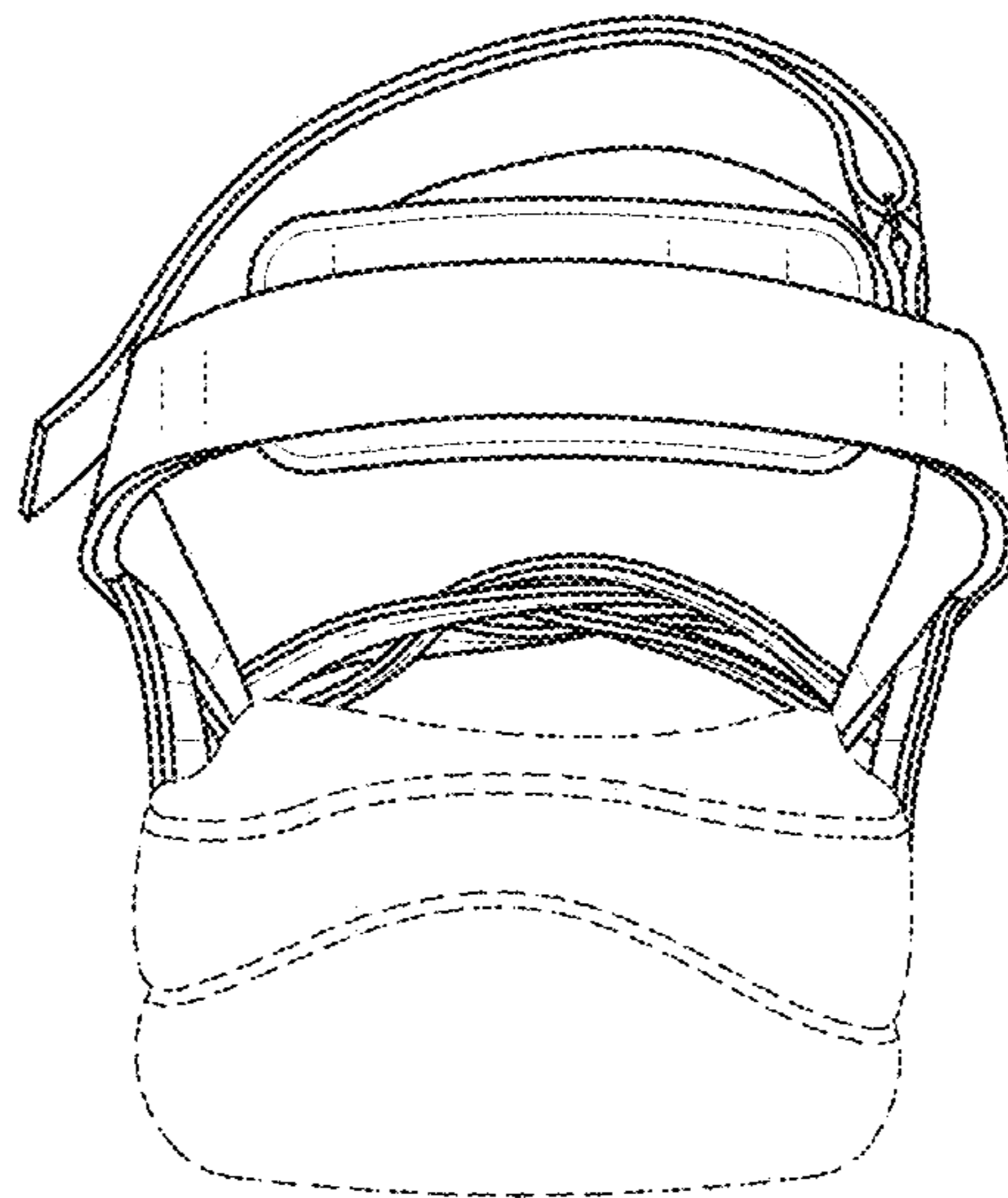

FIG. 4

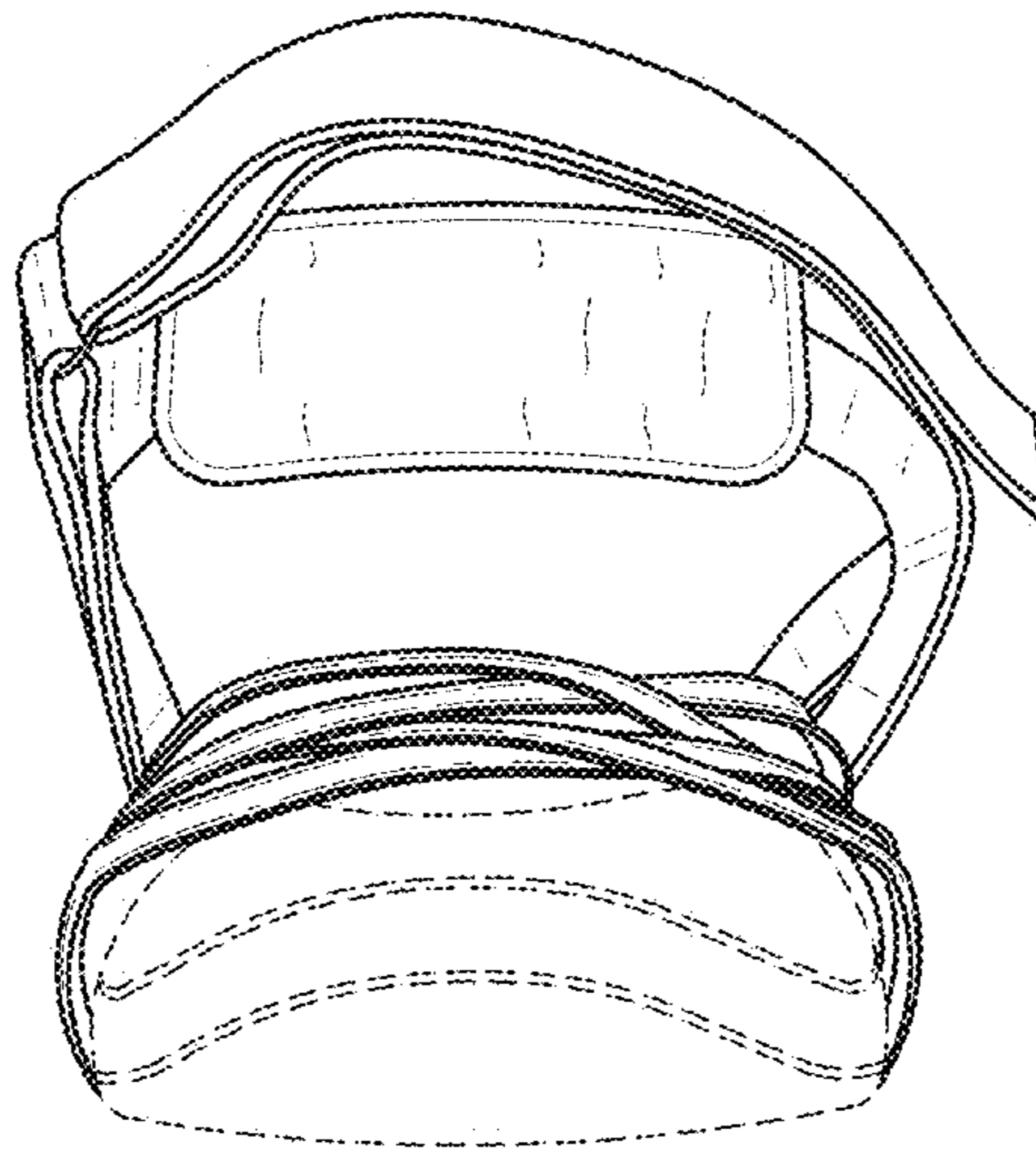

FIG. 5

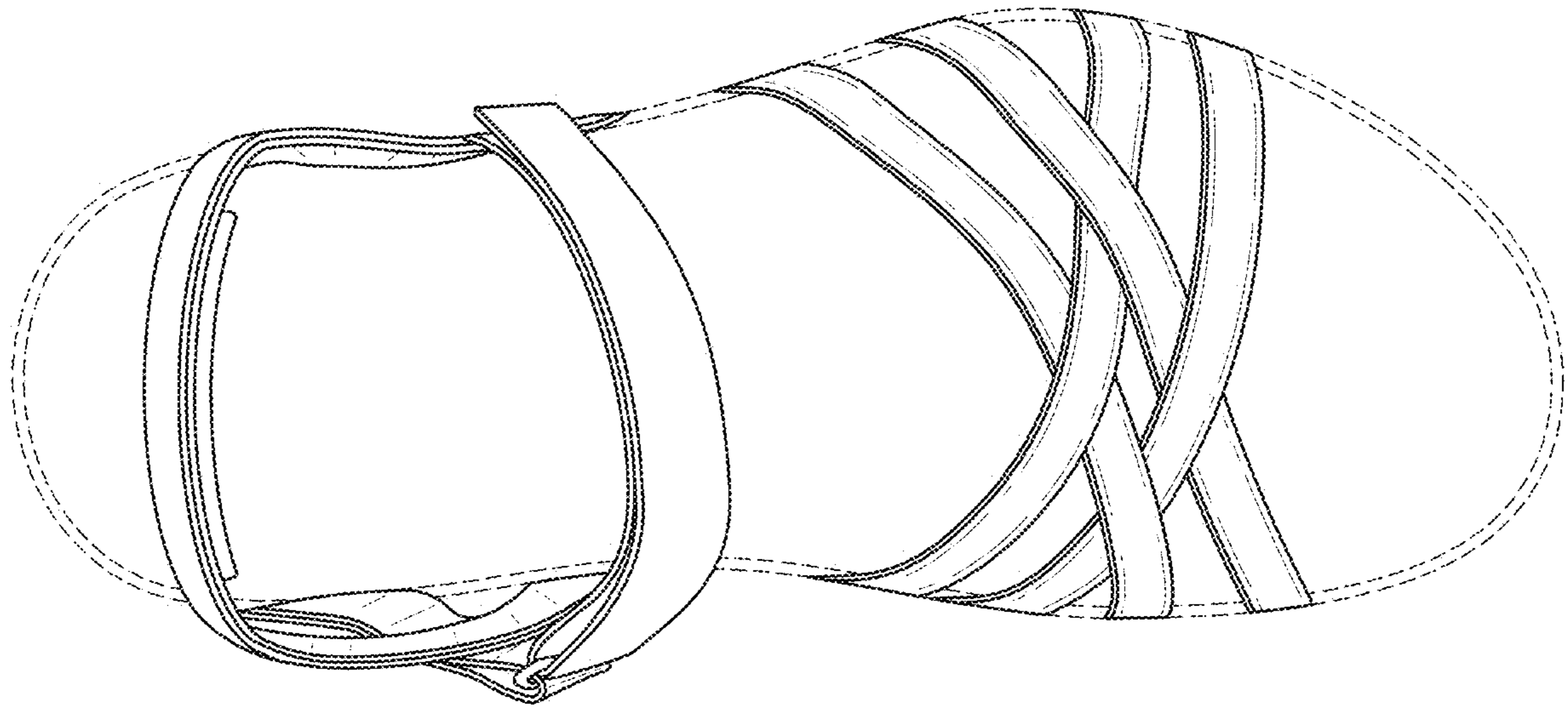

FIG. 6