



US00D894537S

(12) **United States Design Patent** (10) **Patent No.:** **US D894,537 S**
Ngan (45) **Date of Patent:** **** Sep. 1, 2020**

(54) **HOODIE WITH POCKET**

(71) Applicant: **Shun On John Ngan**, Carson, CA (US)
(72) Inventor: **Shun On John Ngan**, Carson, CA (US)
(**) Term: **15 Years**
(21) Appl. No.: **29/722,771**
(22) Filed: **Jan. 31, 2020**

(51) **LOC (12) Cl.** **02-02**
(52) **U.S. Cl.**
USPC **D2/825**
(58) **Field of Classification Search**
USPC D2/823, 825, 826, 828
CPC A41D 1/00; A41D 3/08
See application file for complete search history.

(56) **References Cited**

U.S. PATENT DOCUMENTS

1,097,530	A	5/1914	Cabelinsky	
1,243,206	A	10/1917	Norman	
1,432,249	A	10/1922	Robert	
D108,875	S	3/1938	Friedman	
D113,194	S	1/1939	Storey et al.	
2,372,110	A	3/1945	Noone	
2,967,306	A *	1/1961	Fabanich A41D 3/08 2/94
3,079,611	A	3/1963	Boryszewski	
D196,096	S	8/1963	Griffith et al.	
3,116,491	A	1/1964	Previdi et al.	
3,381,306	A	5/1968	Innes	
D225,489	S	12/1972	Graham	
3,797,043	A	3/1974	Brument	
3,837,006	A	9/1974	Laseman	
4,055,853	A	11/1977	Argento et al.	

(Continued)

FOREIGN PATENT DOCUMENTS

CA	2720578	11/2010
CA	144154	11/2013

(Continued)

OTHER PUBLICATIONS

Open Road Goods; Open Road Goods Surf Poncho/Adult Hooded Towel/Changing Towel/Wetsuit Changing Robe/Swim Parka— Changing Poncho Charcoal Black/Indigo Blue; Saves a Sea Turtle’s Life; https://www.amazon.com/Poncho-Adult-Hooded-Changing-Wetsuit/dp/B07BMR3KJ7/ref=sr_1_10?crd=2T0RU5Y9DSGSP&keywords=surf+poncho&qid=1576195319&sr=8-10, 8 pages.
(Continued)

Primary Examiner — Kevin K Rudzinski
(74) *Attorney, Agent, or Firm* — Cislo & Thomas, LLP

(57) **CLAIM**

The ornamental design for a hoodie with pocket, as shown and described.

DESCRIPTION

FIG. 1 is a perspective view of my hoodie with pocket; FIG. 2 is a front view thereof; FIG. 3 is a right side view thereof; FIG. 4 is a left side view thereof; FIG. 5 is a rear view thereof; FIG. 6 is a top view thereof; and FIG. 7 is a bottom view thereof; FIG. 8 is a perspective view of another embodiment of my hoodie with pocket; FIG. 9 is a front view thereof; FIG. 10 is a right side view thereof; FIG. 11 is a left side view thereof; FIG. 12 is a rear view thereof; FIG. 13 is a top view thereof; FIG. 14 is a bottom view thereof; and, FIG. 15 is a close up of the area designated as 15 in FIG. 9. The broken lines shown in the drawings illustrate portions of my Hoodie with Pocket that form no part of the claimed design.

1 Claim, 11 Drawing Sheets

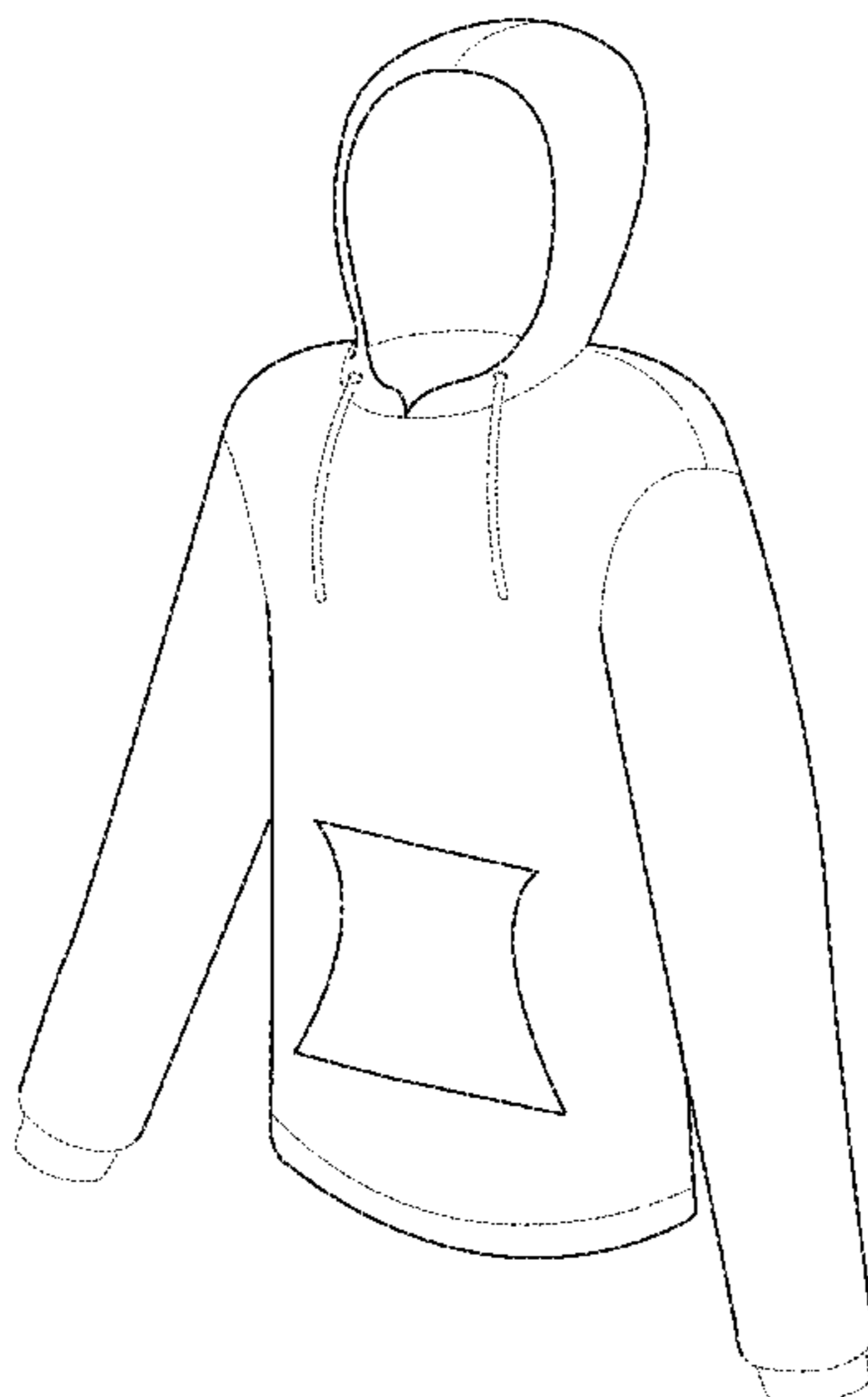

US D894,537 S

(56)

References Cited

U.S. PATENT DOCUMENTS

D247,331 S * 2/1978 Nally D2/844
 D247,526 S * 3/1978 Nally D2/844
 4,078,264 A 3/1978 DeGennaro
 4,227,264 A 10/1980 Spector et al.
 4,370,755 A 2/1983 Crumby
 4,404,687 A 9/1983 Hager
 4,502,155 A 3/1985 Itoi
 D294,535 S * 3/1988 Stricklin D2/831
 D296,605 S 7/1988 Asher
 4,791,681 A * 12/1988 Dean A41D 13/012
 2/102
 4,862,519 A 9/1989 Bull
 4,928,321 A 5/1990 Dobson
 D312,721 S 12/1990 Shea
 5,086,516 A 2/1992 Baxter et al.
 D325,459 S 4/1992 Keever
 5,119,510 A * 6/1992 Schilling A01K 55/00
 2/202
 5,206,957 A 5/1993 Gulick
 D351,712 S 10/1994 Jackson
 D365,193 S 12/1995 Dodd, Jr.
 D385,088 S * 10/1997 Handysides D2/828
 5,697,102 A 12/1997 Benjamin
 5,720,043 A 2/1998 White
 5,787,504 A 8/1998 Wu
 5,850,634 A 12/1998 Toombs
 D414,013 S 9/1999 Group
 5,996,121 A 12/1999 Harris
 6,006,356 A 12/1999 Song
 6,014,772 A 1/2000 Connelly
 D430,721 S 9/2000 Beauchan
 6,185,743 B1 2/2001 Mick
 D439,029 S 3/2001 Goldman
 6,219,847 B1 * 4/2001 Aikins A41D 15/04
 2/69
 6,253,381 B1 * 7/2001 Kelley A41D 3/02
 2/125
 6,275,993 B1 8/2001 McCarley
 D453,607 S 2/2002 Tracy
 6,405,377 B1 * 6/2002 Davis A41D 15/04
 2/108
 D465,317 S 11/2002 Darling
 D478,708 S 8/2003 Miros et al.
 D482,935 S 12/2003 Yamane
 6,760,921 B1 7/2004 Simmons
 D496,144 S 9/2004 Bourget
 6,839,911 B1 * 1/2005 Mathews A41D 15/00
 2/69
 6,848,118 B2 1/2005 Barnes et al.
 D507,693 S 7/2005 Walton
 6,922,848 B1 8/2005 Stanley
 7,065,810 B2 6/2006 Robinson
 D541,011 S 4/2007 Day et al.
 D551,429 S * 9/2007 Wager D2/831
 D553,329 S 10/2007 Wager
 D553,330 S 10/2007 Wager
 D565,456 S 4/2008 Anderson et al.
 7,418,740 B2 * 9/2008 Anderson A41D 3/02
 2/69
 D584,482 S 1/2009 Marsh
 D590,133 S 4/2009 Rogondino
 D591,028 S 4/2009 Rogondino
 D594,633 S 6/2009 Floyd
 D600,884 S 9/2009 Patton
 D601,327 S 10/2009 Anderson et al.
 D608,983 S * 2/2010 Myers D2/857
 D609,432 S 2/2010 Jennings
 D626,310 S 11/2010 Cruz
 D626,720 S 11/2010 Pinkhasov
 D626,725 S 11/2010 Snyder et al.
 D627,540 S * 11/2010 Claey's D2/750
 D629,590 S * 12/2010 Freedman D2/857
 D630,002 S 1/2011 Brown
 D630,003 S 1/2011 Brown

D630,820 S 1/2011 Wilson
 D636,973 S * 5/2011 Smith D2/830
 D638,612 S 5/2011 Benderradji
 D645,645 S * 9/2011 Dyer D2/823
 D653,836 S * 2/2012 Woyshner D2/750
 D663,105 S 7/2012 Selivon
 D672,531 S * 12/2012 Kelfer D2/750
 D674,167 S 1/2013 Ehler
 D677,859 S 3/2013 Andes
 D677,860 S 3/2013 Kim
 D679,479 S 4/2013 Carrera et al.
 D679,484 S 4/2013 Brown
 8,424,113 B2 * 4/2013 Sprole A47G 9/086
 2/69
 8,424,114 B2 4/2013 Snyder et al.
 D683,523 S 6/2013 Freedman
 D684,341 S 6/2013 Freedman
 D684,409 S 6/2013 Juarez
 D686,408 S 7/2013 Stemlight
 D687,210 S 8/2013 Krafnick
 D690,078 S 9/2013 Anderson
 D690,486 S 10/2013 Yan
 D692,212 S 10/2013 Coward
 8,566,963 B2 * 10/2013 Ryan A41D 27/201
 2/252
 D693,540 S 11/2013 Vanneste
 D693,541 S 11/2013 Vanneste
 8,578,515 B1 11/2013 Petersen
 D701,677 S * 4/2014 Tref D2/744
 D707,466 S 6/2014 Lancaster
 D708,423 S * 7/2014 Adams D2/744
 D714,021 S 9/2014 Bowen
 D714,524 S 10/2014 Borovicka
 8,864,544 B2 10/2014 Anderman et al.
 D721,467 S 1/2015 Tref
 D728,900 S 5/2015 White
 D732,800 S * 6/2015 Brown D2/839
 D736,496 S 8/2015 Gonzalez
 D741,567 S 10/2015 Chang
 D741,576 S * 10/2015 Sakosits D2/833
 D746,551 S 1/2016 Ingram
 D747,075 S 1/2016 Ingram
 D751,272 S 3/2016 Moehring
 9,295,292 B2 3/2016 Sachs
 D754,947 S 5/2016 Borovicka
 9,339,064 B2 * 5/2016 Oliver A41D 1/04
 D758,046 S 6/2016 Grant
 D758,700 S 6/2016 Borovicka
 D762,345 S * 8/2016 Adams D2/744
 9,414,631 B2 8/2016 Schrimpf
 D765,349 S 9/2016 Hou
 D765,351 S * 9/2016 Shaw D2/836
 D767,255 S * 9/2016 Marino D2/750
 D769,580 S * 10/2016 Conway D2/830
 D770,136 S 11/2016 Darmour
 9,554,601 B2 1/2017 Arajakis
 D784,659 S 4/2017 Darmour
 D785,285 S 5/2017 Shamsid-Deen
 D785,906 S 5/2017 Darmour
 D787,160 S 5/2017 Crowe et al.
 D790,809 S 7/2017 Lomax
 D792,678 S 7/2017 Storlie et al.
 9,713,352 B2 7/2017 Demarest
 D801,005 S 10/2017 Perez
 9,775,387 B2 10/2017 Parr
 D801,948 S 11/2017 Picunko
 D802,884 S 11/2017 Bennett
 D802,886 S 11/2017 Salce, Jr. et al.
 D809,745 S * 2/2018 Crowe D2/828
 D810,401 S 2/2018 Darmour
 D810,402 S 2/2018 Darmour
 D811,051 S 2/2018 Darmour et al.
 D815,801 S 4/2018 Torre
 D820,560 S 6/2018 Reynolds et al.
 D822,344 S 7/2018 Karim
 D827,247 S 9/2018 Genender
 D827,248 S 9/2018 Genender
 D827,249 S 9/2018 Darmour et al.
 10,080,391 B2 9/2018 Rundle

(56)

References Cited

U.S. PATENT DOCUMENTS

D830,735 S 10/2018 Johnson
 D831,937 S 10/2018 James
 10,130,126 B2 11/2018 Blauser
 D839,539 S 2/2019 Jones
 D839,546 S 2/2019 Noiberg
 D840,133 S * 2/2019 Peck D2/840
 D841,289 S * 2/2019 Frost D2/750
 D842,589 S 3/2019 Johnson
 10,265,636 B2 4/2019 Anderman et al.
 D854,787 S 7/2019 Ngan
 D856,032 S 8/2019 Hindley
 D859,788 S 9/2019 Speciale et al.
 10,420,431 B1 9/2019 Speciale et al.
 D862,841 S 10/2019 Lomax
 D862,843 S * 10/2019 Darmour D2/840
 D862,845 S * 10/2019 Plant D2/857
 10,485,278 B2 11/2019 Noll et al.
 D886,416 S * 6/2020 Speciale D2/828
 2001/0032360 A1 10/2001 Bertrand
 2002/0142112 A1 * 10/2002 Tarrell F41H 3/00
 428/17
 2003/0061659 A1 4/2003 Dunlap
 2003/0182714 A1 10/2003 Mariland et al.
 2004/0181844 A1 9/2004 Kim
 2004/0237167 A1 12/2004 Curry
 2005/0144695 A1 7/2005 Aldridge et al.
 2006/0010555 A1 1/2006 Hayes
 2007/0050882 A1 3/2007 Eisenhuth
 2007/0061940 A1 3/2007 Cazares
 2007/0083983 A1 4/2007 Barclay
 2007/0157359 A1 * 7/2007 Reardon A41D 13/1245
 2/69
 2007/0266473 A1 * 11/2007 Issel A41D 27/20
 2/84
 2008/0056508 A1 * 3/2008 Pierce H04R 5/02
 381/87
 2008/0120774 A1 5/2008 Hite
 2008/0196140 A1 * 8/2008 Mayerson A41D 27/10
 2/84
 2008/0250560 A1 10/2008 Armstrong
 2009/0055991 A1 * 3/2009 Johnson A41D 1/04
 2/84
 2009/0144874 A1 6/2009 Stein
 2009/0165206 A1 7/2009 Davis
 2009/0205117 A1 8/2009 Day et al.
 2009/0229034 A1 9/2009 Zmigrosky
 2009/0235426 A1 * 9/2009 Johnston A41D 3/005
 2/84
 2010/0115684 A1 * 5/2010 Freedman A41D 1/04
 2/128
 2010/0122395 A1 5/2010 Wall et al.
 2010/0146680 A1 6/2010 Cuoco
 2010/0186166 A1 7/2010 Sulentic
 2011/0179559 A1 7/2011 Smoot
 2011/0185471 A1 * 8/2011 Buczkowski A41D 27/201
 2/84
 2011/0206299 A1 8/2011 Carmody
 2012/0005802 A1 * 1/2012 Claeys A41D 27/204
 2/84
 2012/0023635 A1 2/2012 Ehler
 2012/0060254 A1 3/2012 Blade
 2012/0144550 A1 6/2012 Nejad
 2013/0000010 A1 * 1/2013 Ryan A41D 27/201
 2/84
 2013/0019378 A1 1/2013 White
 2013/0042383 A1 * 2/2013 Ryan A41D 15/00
 2/84

2013/0130540 A1 * 5/2013 Oman A41D 1/005
 439/527
 2013/0152269 A1 * 6/2013 Coward A41D 13/08
 2/84
 2013/0152270 A1 * 6/2013 Neal A41D 3/005
 2/84
 2013/0219581 A1 * 8/2013 Schrimpf A41D 27/20
 2/69
 2013/0219616 A1 8/2013 Bozek
 2013/0269082 A1 * 10/2013 Bramblet A41D 1/215
 2/104
 2014/0068834 A1 3/2014 Skinner
 2014/0082818 A1 3/2014 Nysheva-Starr
 2014/0096305 A1 * 4/2014 Friesen A41D 3/00
 2/84
 2014/0215689 A1 8/2014 Perez
 2014/0237700 A1 8/2014 Albert
 2014/0259275 A1 9/2014 Walvius et al.
 2014/0310848 A1 10/2014 Ulriksen
 2014/0317624 A1 10/2014 Browning et al.
 2014/0331381 A1 11/2014 Arajakis
 2015/0121604 A1 5/2015 Lee et al.
 2015/0135397 A1 5/2015 Levine
 2015/0150319 A1 6/2015 Walmsley
 2015/0196061 A1 * 7/2015 Oliver A24F 47/008
 2/84
 2015/0250337 A1 9/2015 Gould
 2015/0296898 A1 10/2015 Bowen
 2015/0296909 A1 10/2015 Sachs
 2016/0157535 A1 6/2016 Tirro et al.
 2016/0174633 A1 6/2016 Macrae
 2016/0242474 A1 8/2016 Baschak
 2016/0309799 A1 10/2016 Nysheva-Starr
 2017/0020215 A1 * 1/2017 Merritt A41D 1/04
 2017/0079350 A1 * 3/2017 Hourani A41D 27/201
 2017/0164665 A1 * 6/2017 Johnson A41D 15/00
 2017/0224033 A1 8/2017 Latta, Jr.
 2017/0265545 A1 9/2017 Peng
 2017/0280793 A1 10/2017 Reyes
 2017/0311655 A1 11/2017 Gonzalez
 2018/0027889 A1 * 2/2018 Frost A41D 1/04
 2018/0049489 A1 2/2018 Noll
 2018/0092410 A1 4/2018 Rundle
 2018/0368496 A1 12/2018 Berrebi
 2019/0142089 A1 5/2019 Emes
 2019/0216191 A1 7/2019 Botha et al.
 2019/0254410 A1 8/2019 DuVall
 2019/0269184 A1 * 9/2019 Gracie A41D 15/04
 2020/0008500 A1 * 1/2020 Speciale A41D 15/04

FOREIGN PATENT DOCUMENTS

GB 2551262 12/2017
 JP 1046408 2/1998
 JP 2006207103 8/2006
 NL 9302143 7/1995
 WO DM 091998 10/2016
 WO 2018222868 6/2018

OTHER PUBLICATIONS

Koretamp Poncho Liner posted to bushcraftoutfitters.com. Available date Jul. 17, 2019 [site visited Mar. 20, 2020]. Available: <<https://bushcraftoutfitters.com/koretamp-poncho-liner/>> (Year: 2019).
 Ho Stevie! Surf Poncho posted to amazon.com. Available date: Mar. 19, 2016 [site visited Mar. 20, 2020]. Available: <https://www.amazon.com/Ho-Stevie-Microfiber-Wetsuit-Changing/dp/B01CV1P9UG/ref=cm_cr_ar_p_d_product_top?ie=UTF8> (Year: 2016).

* cited by examiner



FIGURE 1

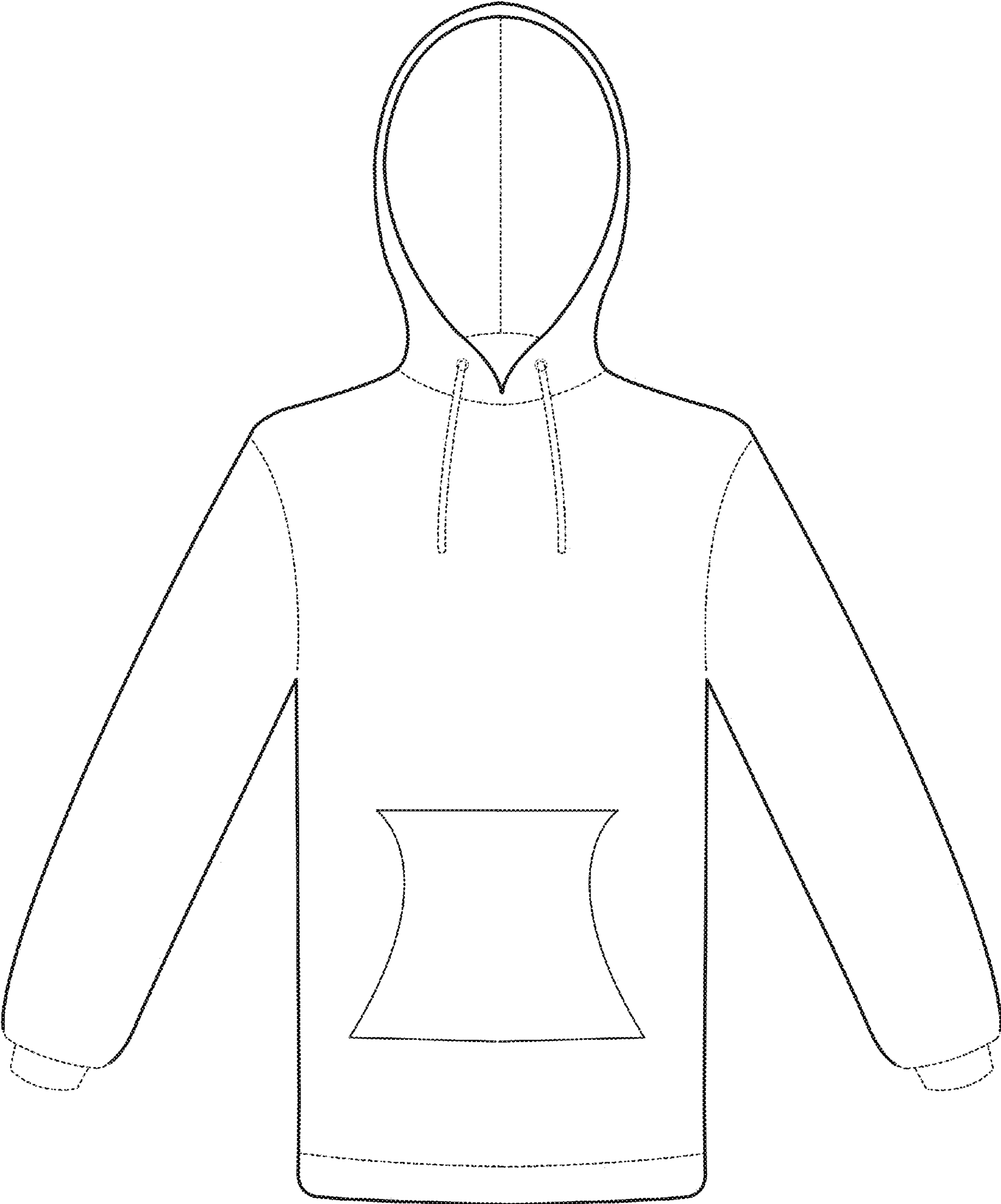

FIGURE 2

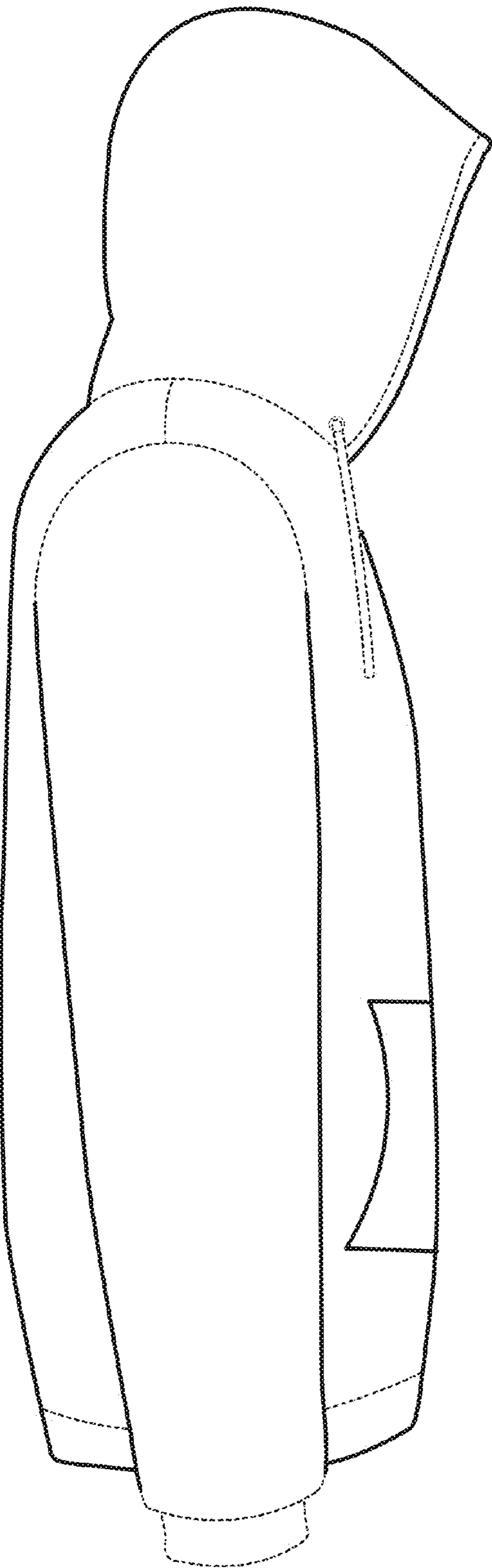

FIGURE 3

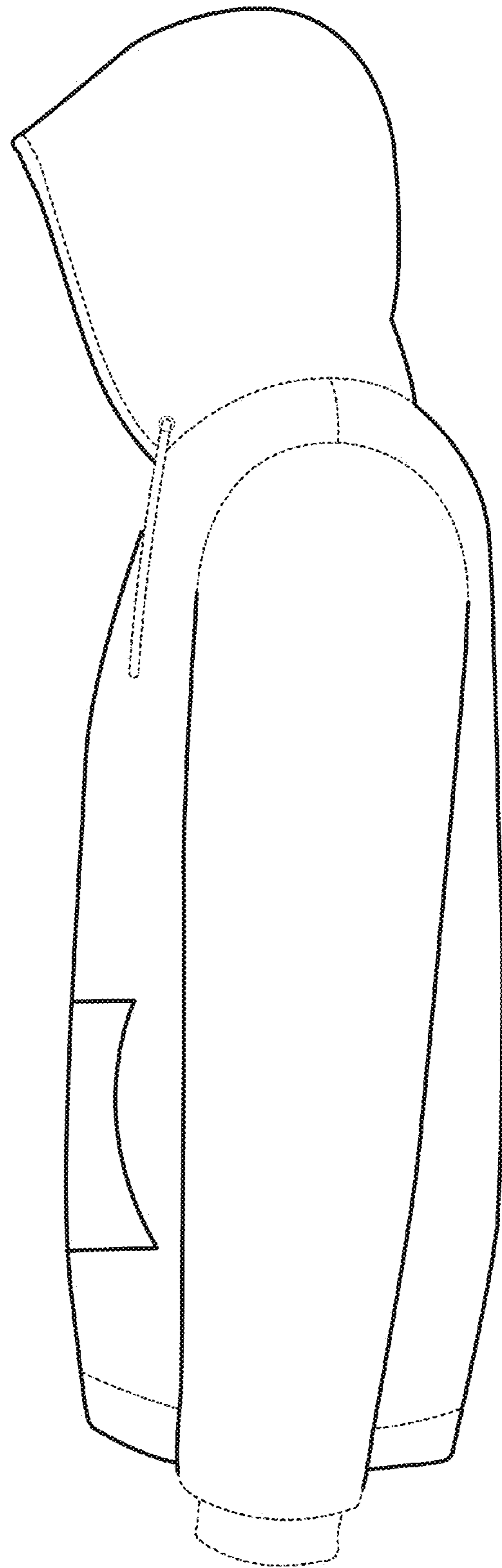

FIGURE 4

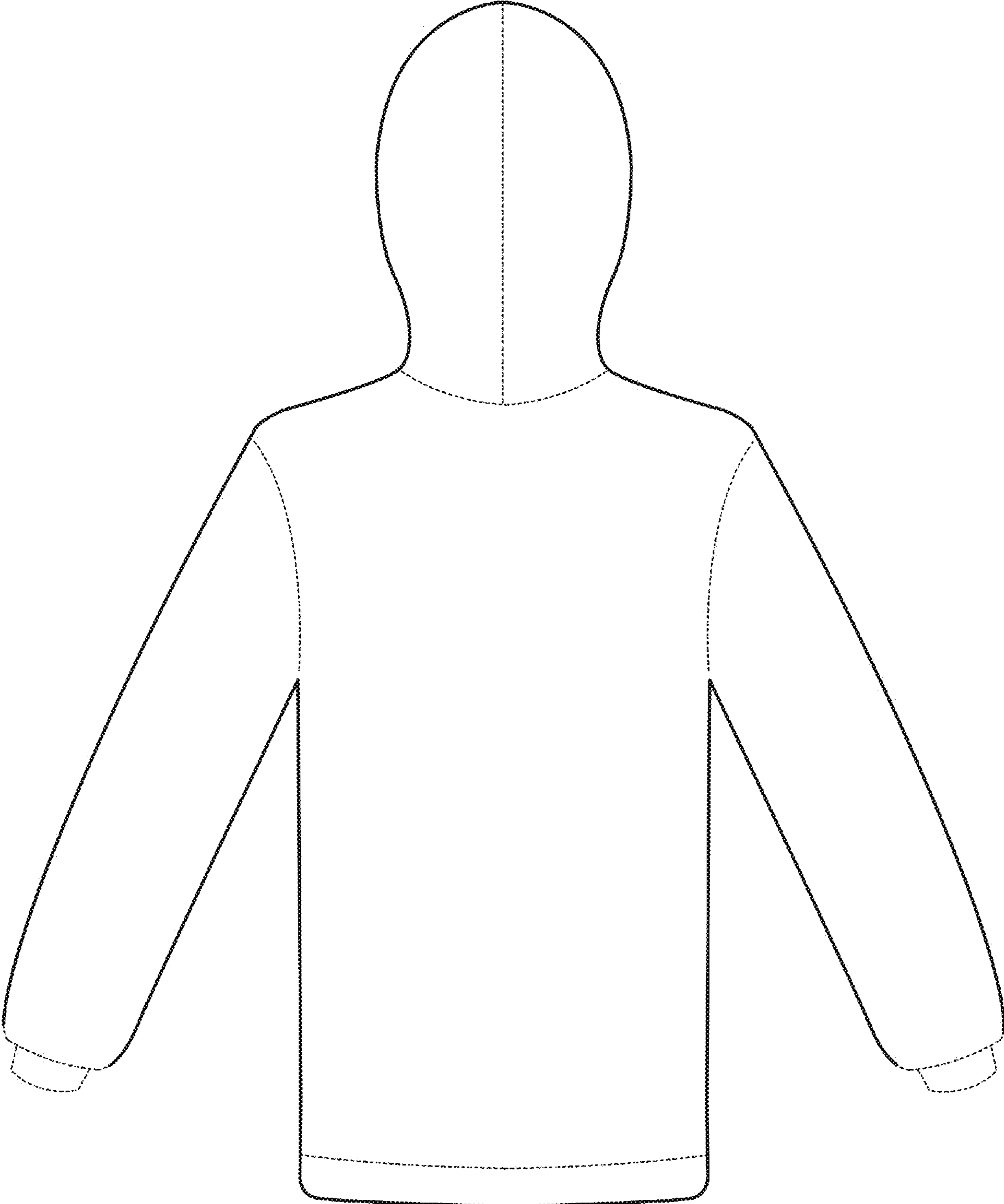

FIGURE 5

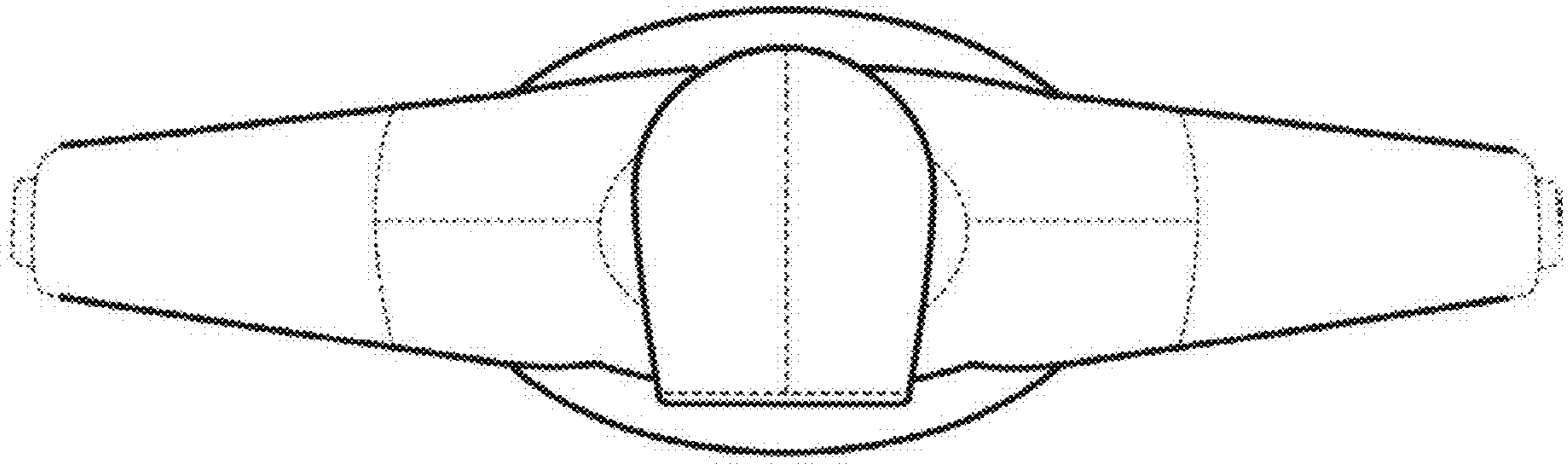

FIGURE 6

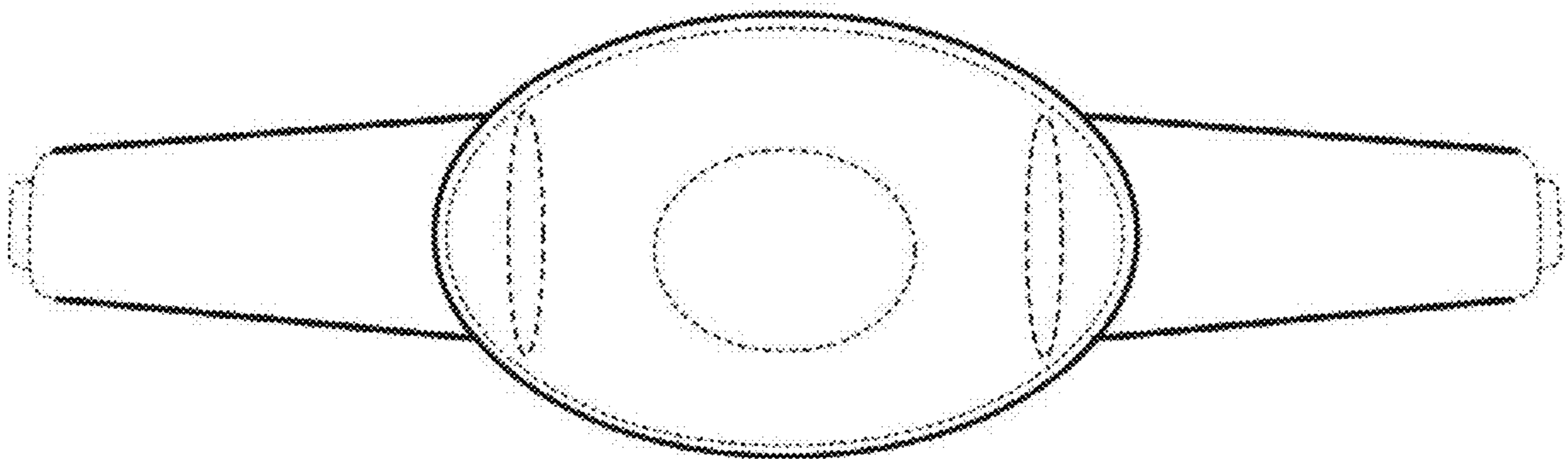

FIGURE 7

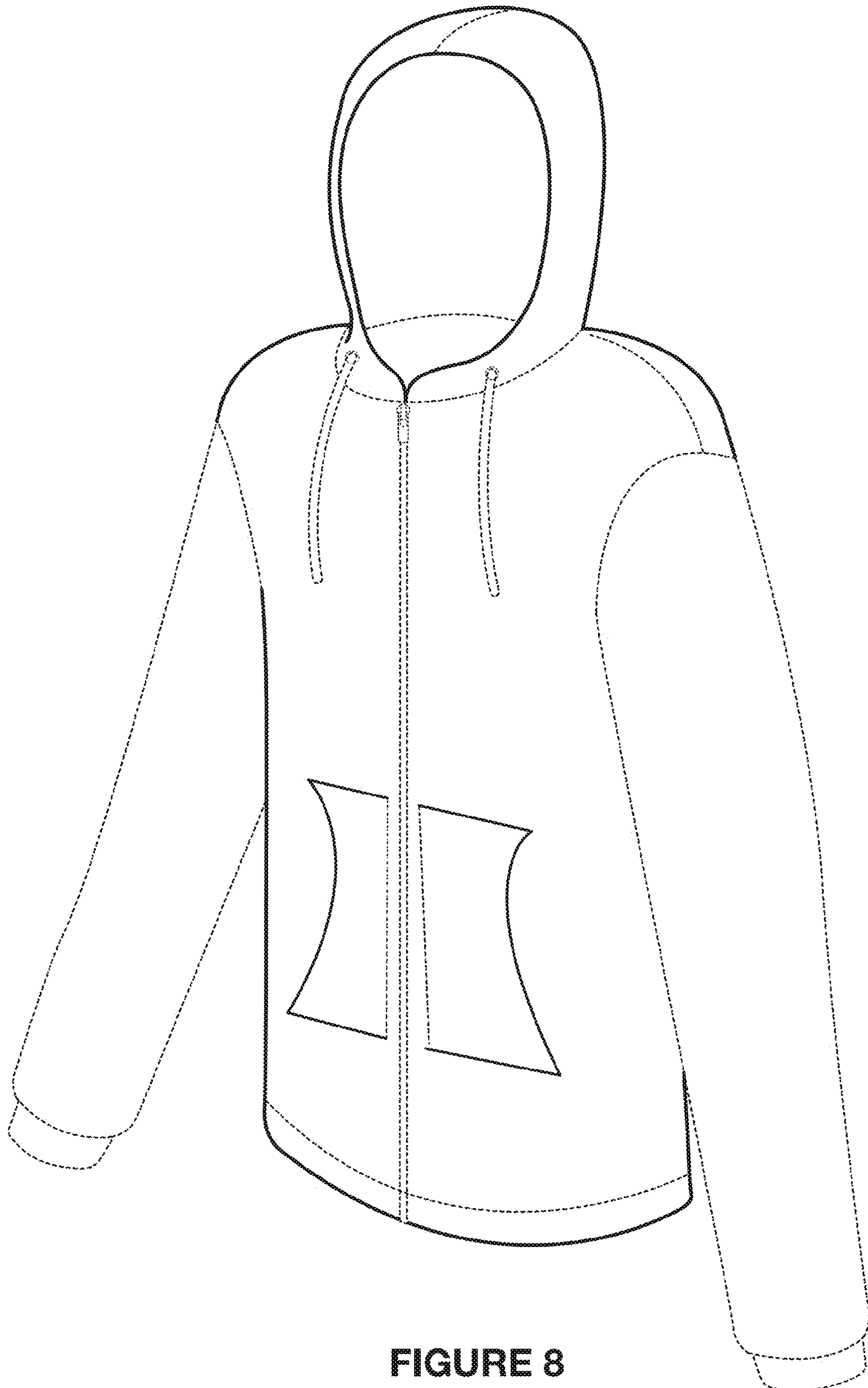

FIGURE 8

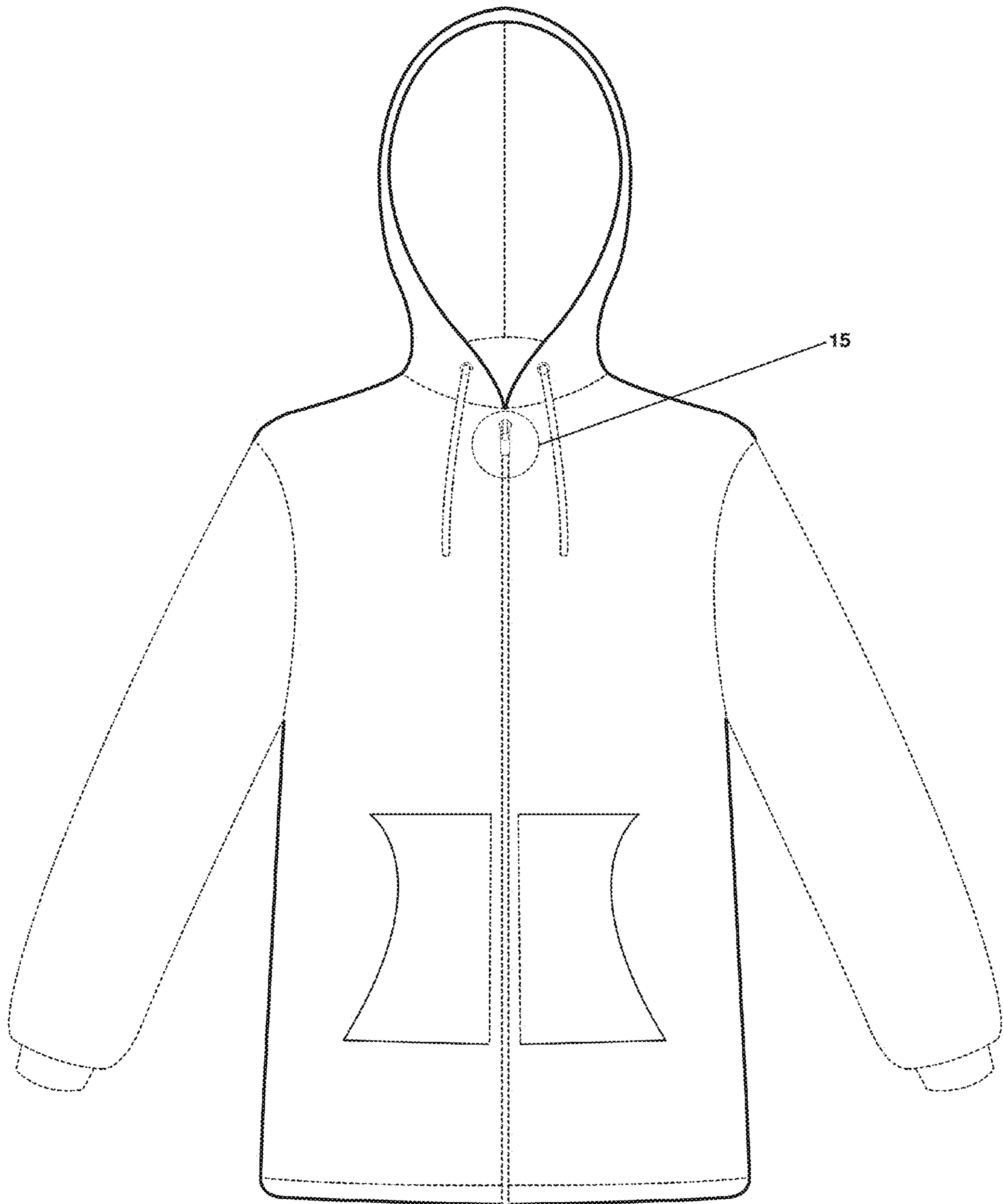

FIGURE 9

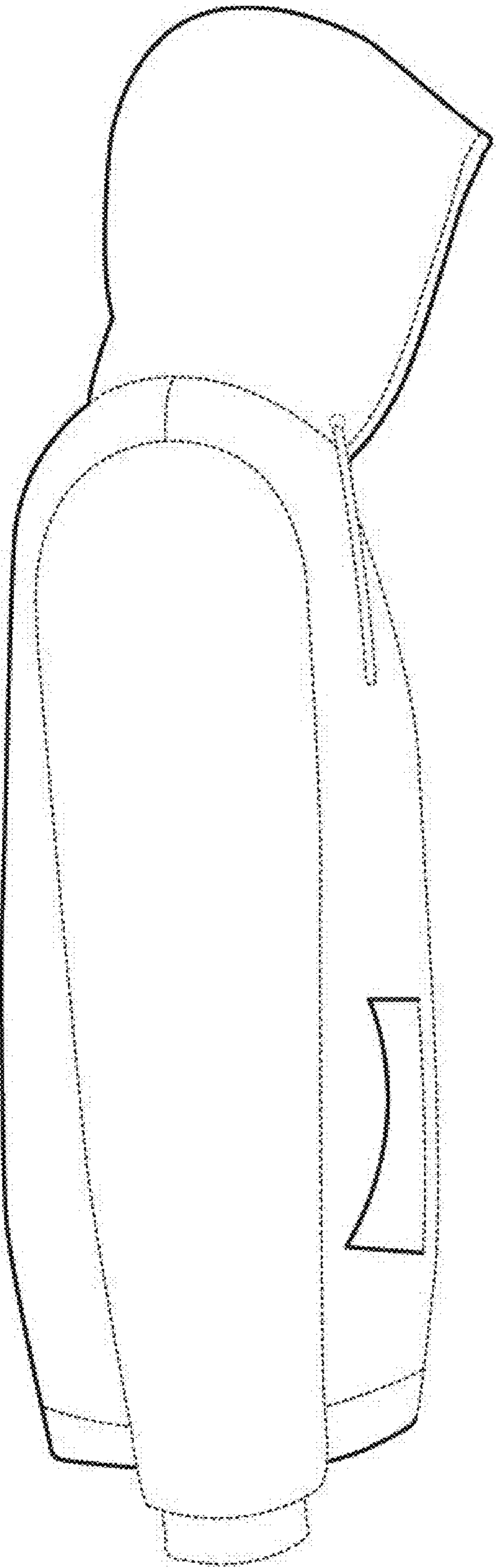

FIGURE 10

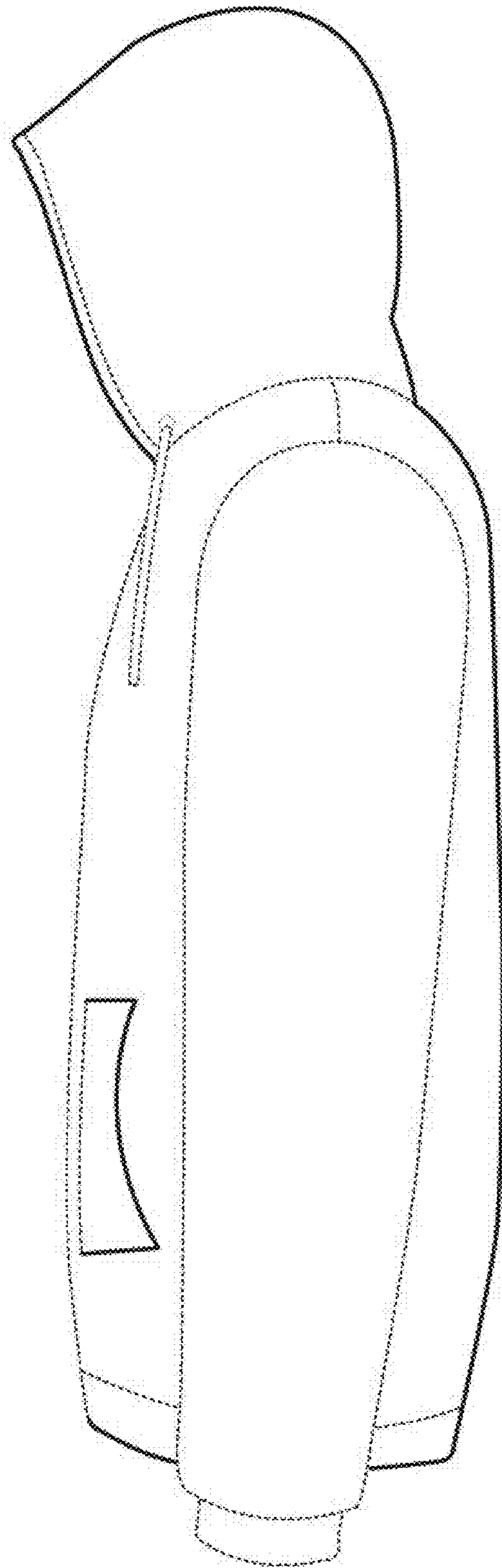

FIGURE 11

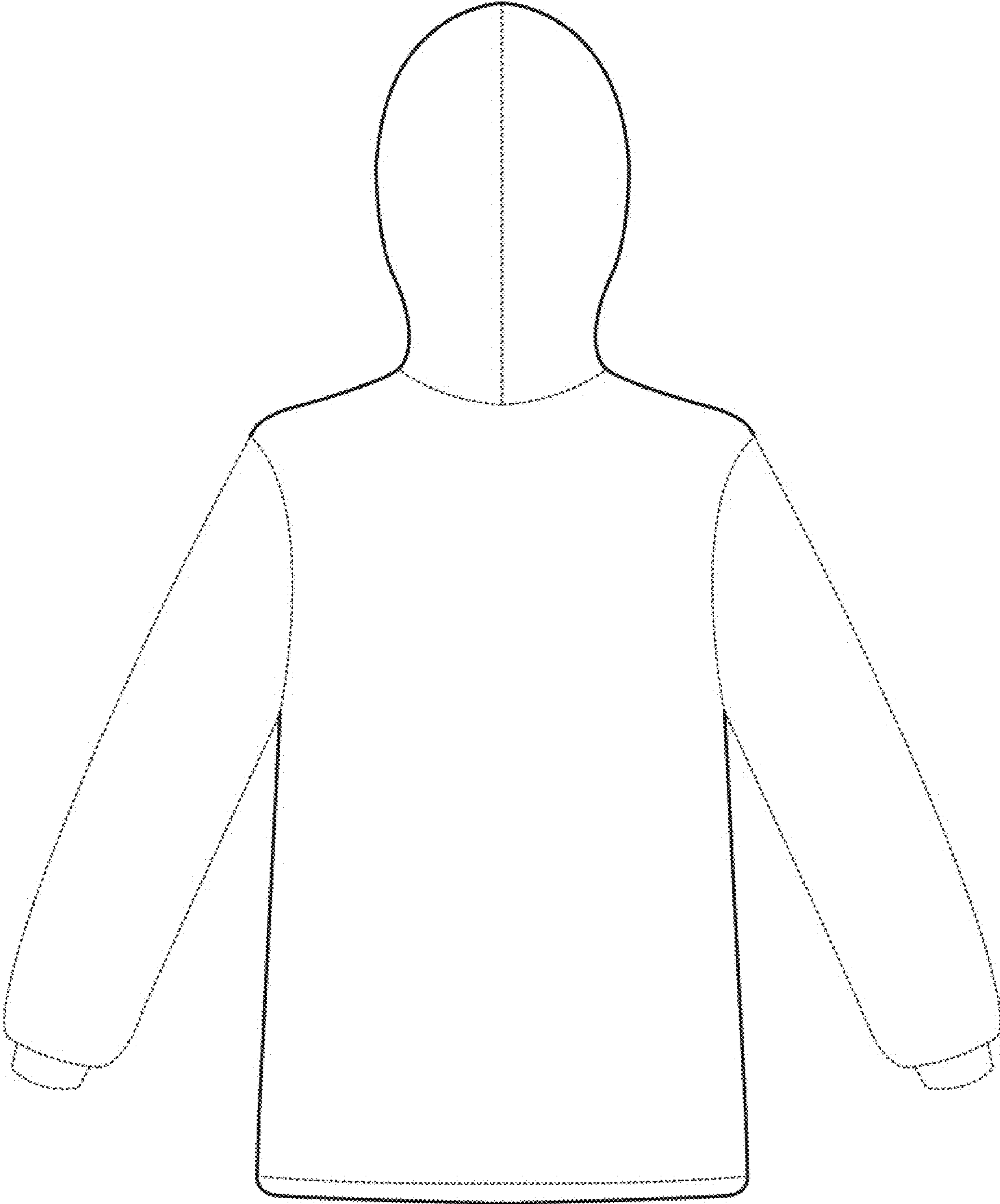

FIGURE 12

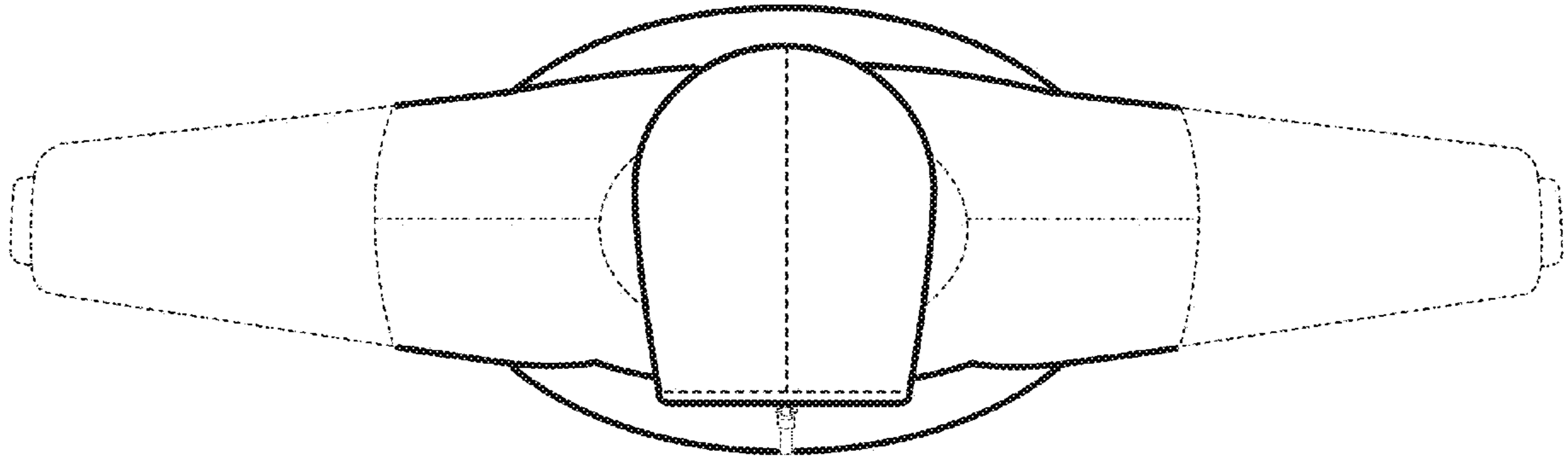

FIGURE 13

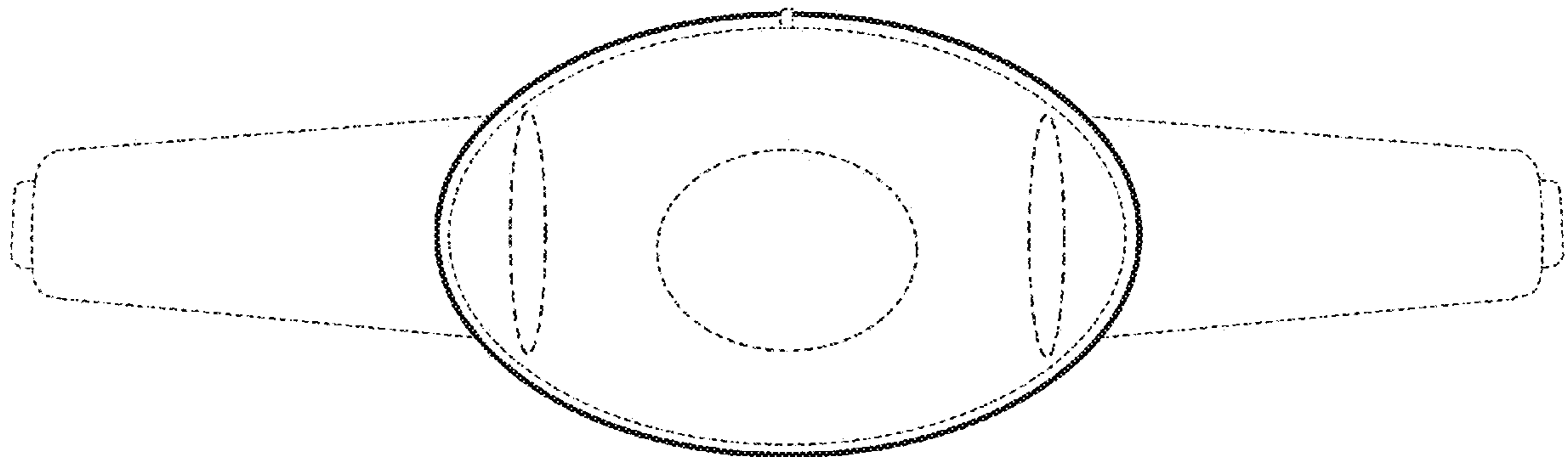

FIGURE 14

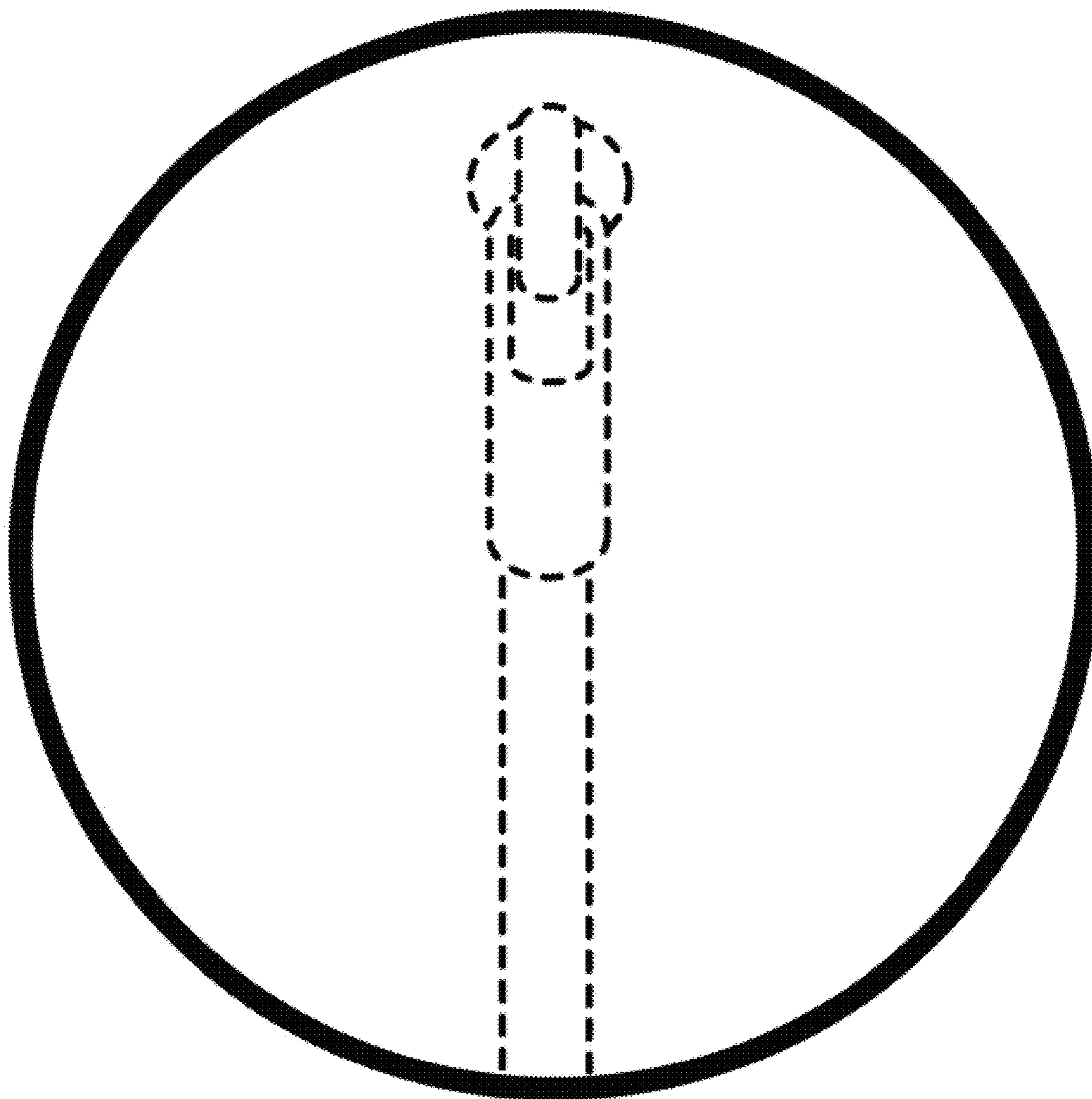

FIGURE 15