



US00D894501S

(12) **United States Design Patent** (10) **Patent No.:** **US D894,501 S**  
**Roost et al.** (45) **Date of Patent:** **\*\* Aug. 25, 2020**

(54) **PET MAT**

(71) Applicant: **Pet Fusion, LLC**, Fanwood, NJ (US)

(72) Inventors: **Andrew Roost**, Fanwood, NJ (US);  
**Theodore Elliott**, Bentleyville, OH (US)

(73) Assignee: **Pet Fusion, LLC**, Fanwood, NJ (US)

(\*\*) Term: **15 Years**

(21) Appl. No.: **29/658,053**

(22) Filed: **Jul. 27, 2018**

(51) **LOC (12) Cl.** ..... **30-03**

(52) **U.S. Cl.**  
USPC ..... **D30/133**

(58) **Field of Classification Search**  
USPC ..... D30/121, 122, 133, 160, 199  
CPC ..... A01K 5/00  
See application file for complete search history.

(56) **References Cited**

**U.S. PATENT DOCUMENTS**

D387,512 S	*	12/1997	Bergman	.....	D30/119
D613,464 S	*	4/2010	Cook	.....	D30/161
D688,838 S	*	8/2013	Elliott	.....	D30/161
D743,185 S	*	11/2015	Elliott	.....	D6/582
D751,773 S	*	3/2016	Gailen	.....	D30/121
D765,922 S	*	9/2016	Sayan	.....	D30/119
D799,759 S	*	10/2017	Elliott	.....	D30/161
D840,174 S	*	2/2019	Kraemer	.....	D6/585
D845,031 S	*	4/2019	Huang	.....	D6/586
D856,027 S	*	8/2019	Chang	.....	D6/583

**OTHER PUBLICATIONS**

“PetFusion Toughgrip Large Plus Dog Food Mat” available Jun. 27, 2018, [online], [site visited Apr. 10, 2020]. Retrieved from Internet, URL: [https://www.amazon.com/PetFusion-Toughgrip-Getting-Waterproof-Silicone/product-reviews/B07D6CQC56/ref=cm\\_cr\\_getr\\_d\\_paging\\_btm\\_next\\_10](https://www.amazon.com/PetFusion-Toughgrip-Getting-Waterproof-Silicone/product-reviews/B07D6CQC56/ref=cm_cr_getr_d_paging_btm_next_10) (Year: 2018).\*

\* cited by examiner

*Primary Examiner* — Michael C Stout

*Assistant Examiner* — Katrina N Gonzalez

(74) *Attorney, Agent, or Firm* — Myers Wolin, LLC

(57) **CLAIM**

The ornamental design for a pet mat, as shown and described.

**DESCRIPTION**

FIG. 1 is a top perspective view of a pet mat showing our new design.

FIG. 2 is a bottom perspective view thereof;

FIG. 3 is a top plan view thereof;

FIG. 4 is a front elevation view thereof, the rear elevation view being a mirror image thereof;

FIG. 5 is a bottom plan view thereof;

FIG. 6 is a right side elevation view thereof, the left side elevation view being a mirror image thereof; and,

FIG. 7 is a cross-sectional front view taken along and in the direction of line 7-7 in FIG. 3.

The broken lines showing “logo” illustrates environmental structure that forms no part of the claimed design.

**1 Claim, 5 Drawing Sheets**

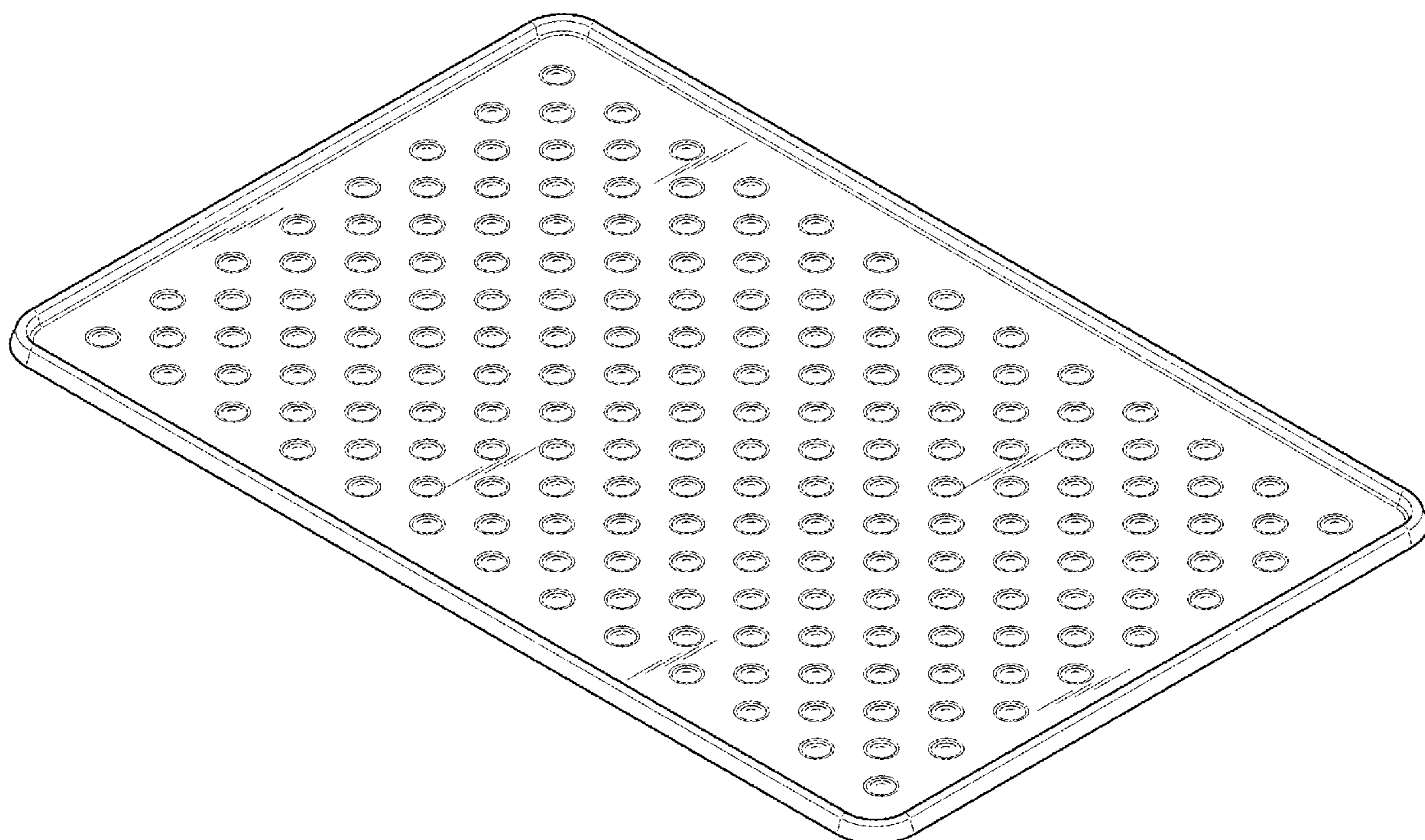

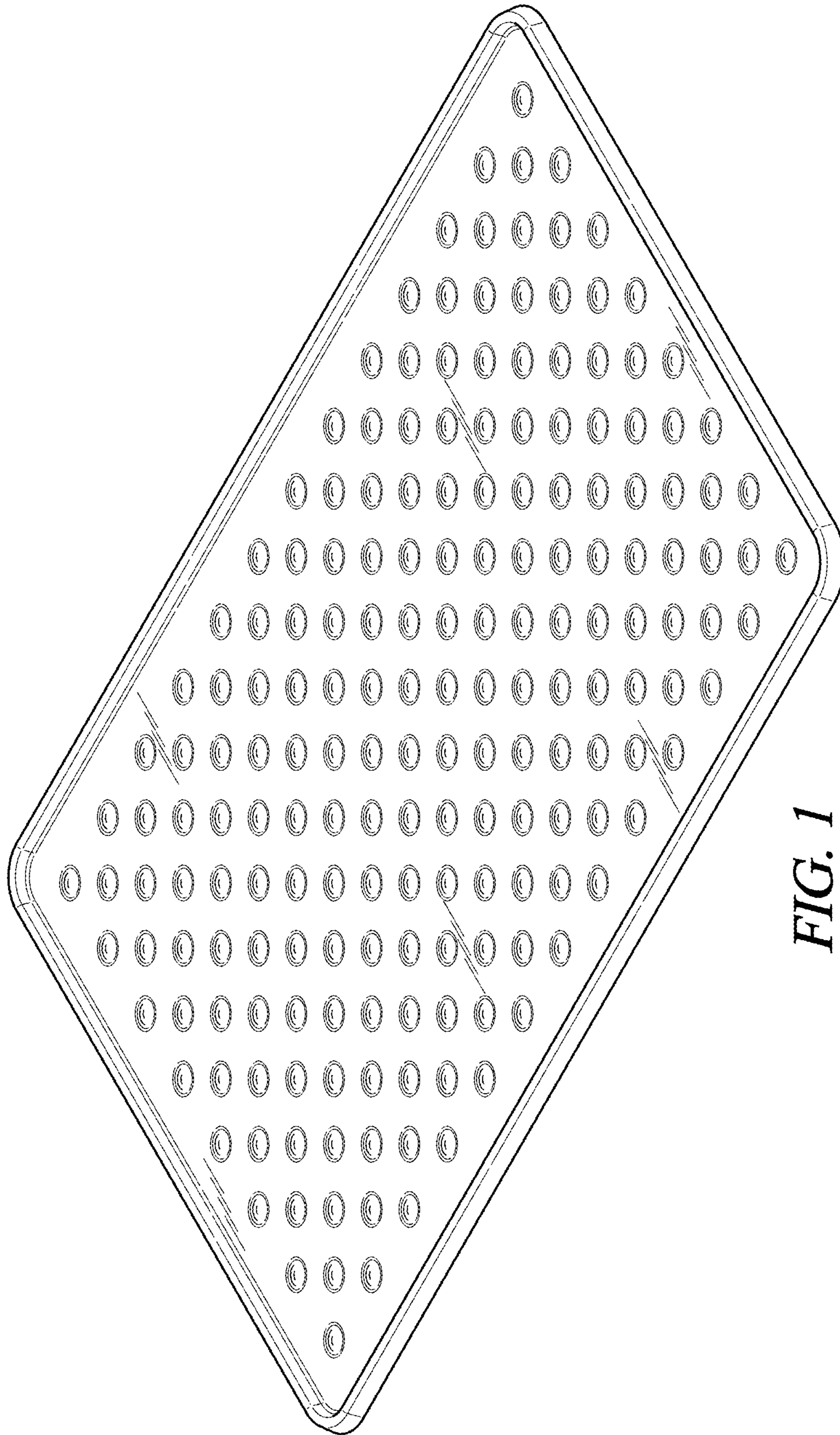

FIG. 1



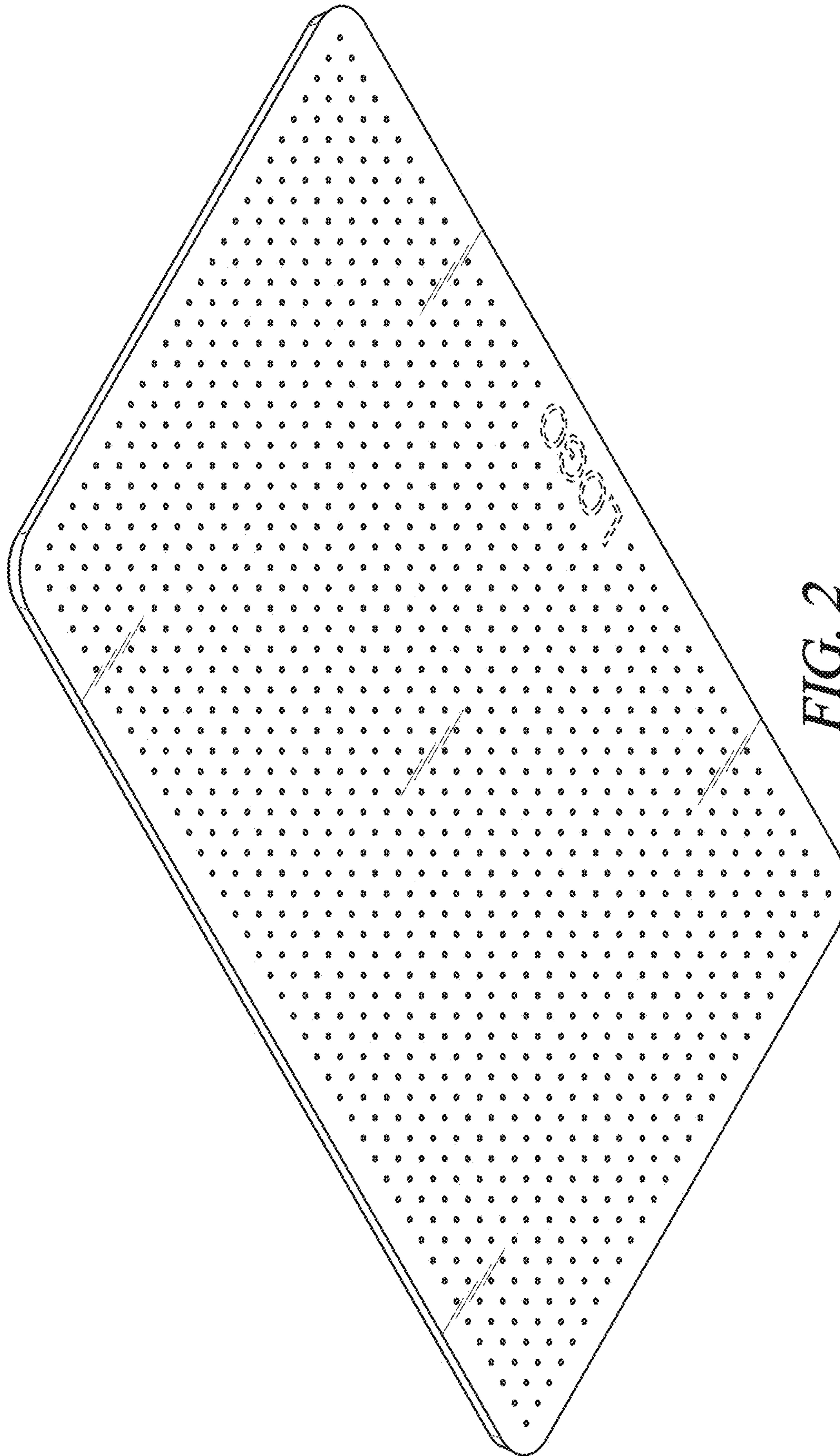

FIG. 2

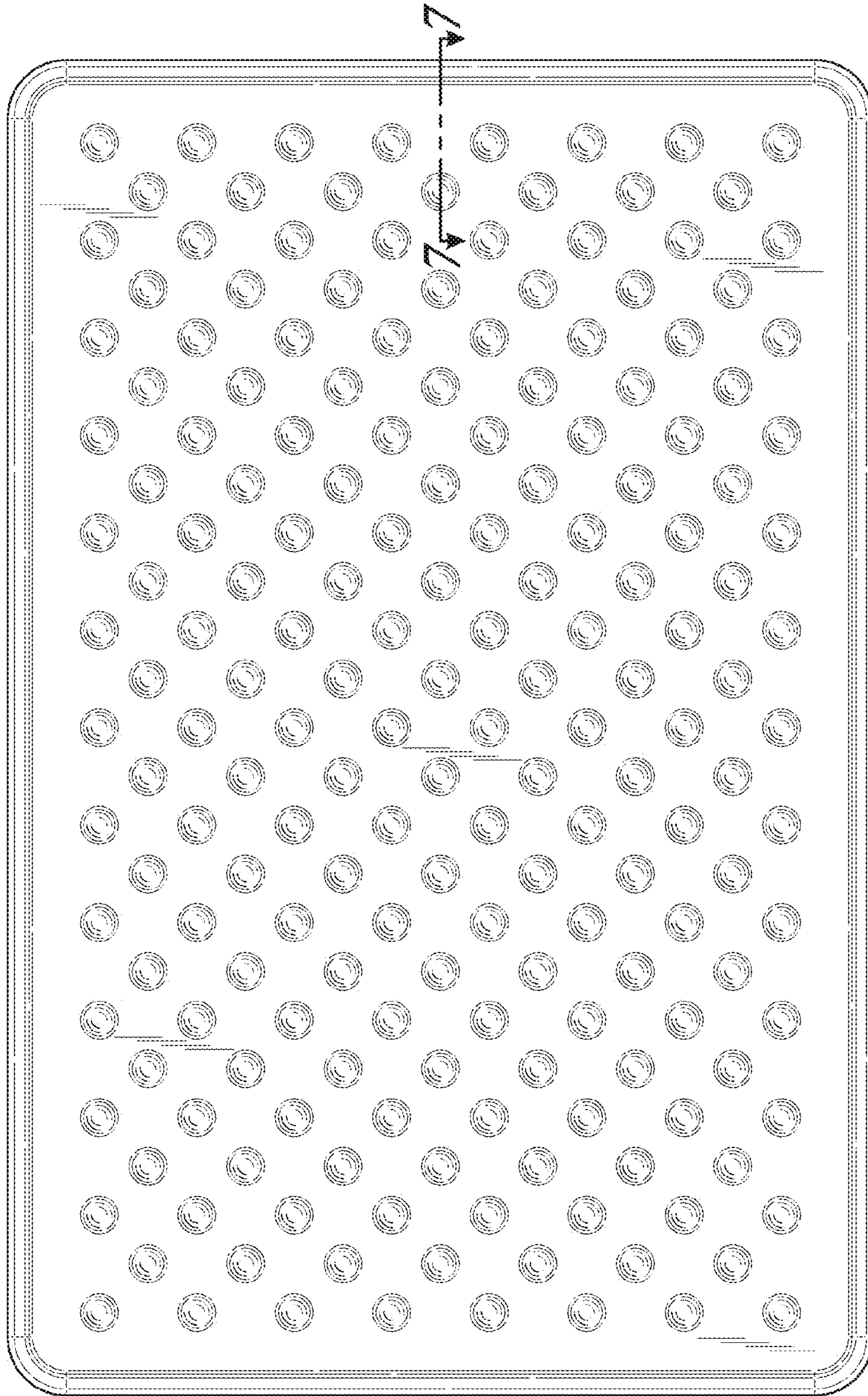

FIG. 3

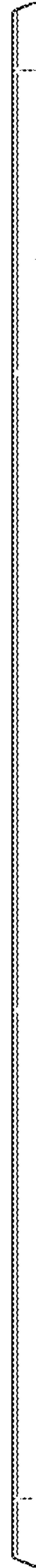

FIG. 4



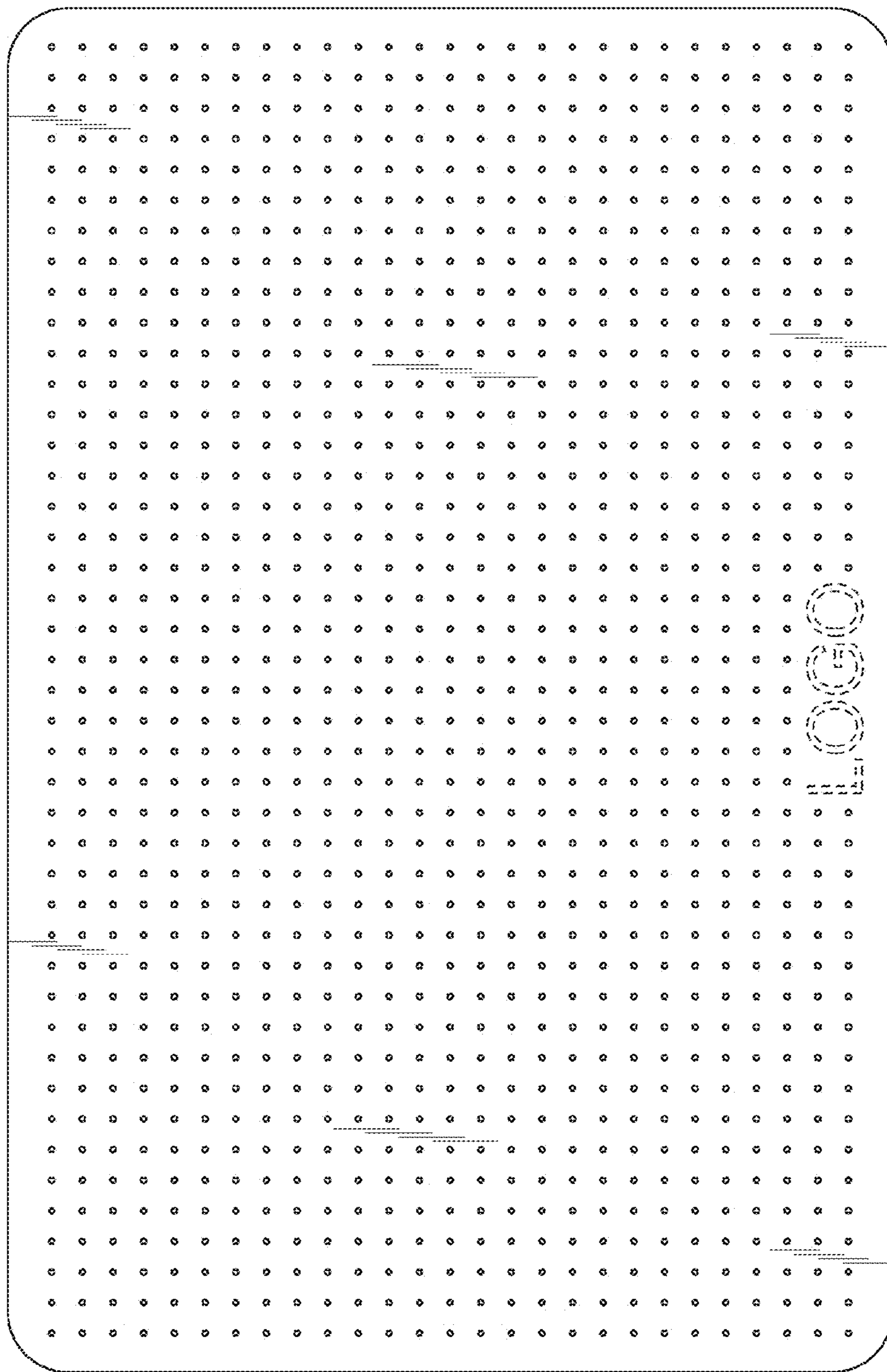

FIG. 5

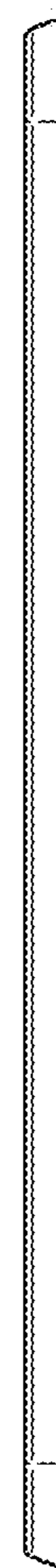

FIG. 6

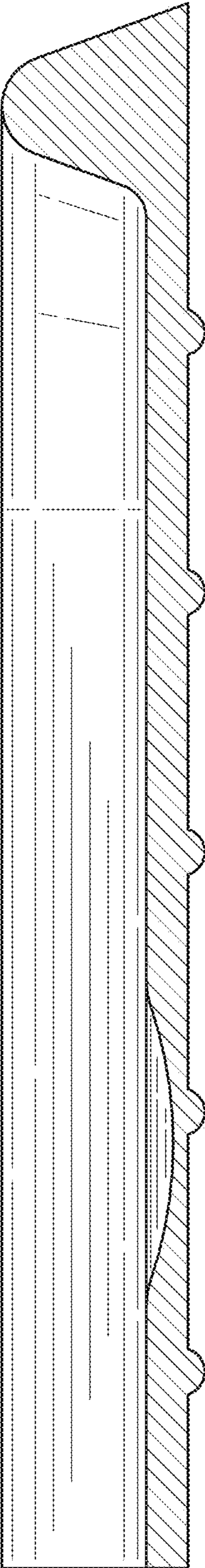

FIG. 7