

US00D894474S

(12) **United States Design Patent** (10) **Patent No.:** **US D894,474 S**
Antoni (45) **Date of Patent:** **** Aug. 25, 2020**

- (54) **ADJUSTABLE LUMINAIRE**
- (71) Applicant: **Beta-Calco Inc.**, Toronto (CA)
- (72) Inventor: **Jacob Antoni**, Toronto (CA)
- (73) Assignee: **Beta-Calco Inc.**, Toronto (CA)
- (**) Term: **15 Years**
- (21) Appl. No.: **29/709,819**
- (22) Filed: **Oct. 17, 2019**

Related U.S. Application Data

- (62) Division of application No. 29/621,106, filed on Oct. 4, 2017, now Pat. No. Des. 882,862.

(30) **Foreign Application Priority Data**

Apr. 4, 2017 (CA) 173952

- (51) **LOC (12) Cl.** **26-99**

- (52) **U.S. Cl.**
USPC **D26/138**

- (58) **Field of Classification Search**
USPC D26/113, 118, 155, 141, 138, 72, 80;
D11/141; D19/61, 62; D21/579, 468,
D21/707, 498, 398

(Continued)

(56) **References Cited**

U.S. PATENT DOCUMENTS

- 4,578,291 A * 3/1986 Miner B44C 5/00
428/542.2
- D423,403 S * 4/2000 Flowers D11/141

(Continued)

OTHER PUBLICATIONS

- Photographs of Sochi Olympics Rings (Opening Ceremony in 2014).
- Photograph of light fixture by Héméra.

Primary Examiner — Brian N. Vinson
(74) *Attorney, Agent, or Firm* — Renner, Otto, Boisselle & Sklar, LLP

(57) **CLAIM**

The ornamental design for an adjustable luminaire, as shown and described.

DESCRIPTION

FIG. 1 is a top perspective view of a first embodiment of an adjustable luminaire showing my new design;
 FIG. 2 is a top view thereof;
 FIG. 3 is a bottom view thereof;
 FIG. 4 is a front view thereof;
 FIG. 4A is an enlarged fragmentary view of the portion identified in FIG. 4;
 FIG. 5 is a rear view of the adjustable luminaire shown in FIG. 1;
 FIG. 6 is a right-side view thereof;
 FIG. 7 is a left-side view thereof;
 FIG. 8 is a bottom view thereof in a half-open position;
 FIG. 9 is a bottom view thereof in an open position;
 FIG. 10 is a top perspective view of a second embodiment of an adjustable luminaire showing my new design;
 FIG. 11 is a top view thereof;
 FIG. 12 is a bottom view thereof;
 FIG. 13 is a front view thereof;
 FIG. 13A is an enlarged fragmentary view of the portion identified in FIG. 13;
 FIG. 14 is a rear view of the adjustable luminaire shown in FIG. 10;
 FIG. 15 is a right-side view thereof;
 FIG. 16 is a left-side view thereof;
 FIG. 17 is a bottom view thereof in a half-open position;
 FIG. 18 is a bottom view thereof in an open position;
 FIG. 19 is a top perspective view of a third embodiment of an adjustable luminaire showing my new design;
 FIG. 20 is a top view thereof;
 FIG. 21 is a bottom view thereof;
 FIG. 22 is a front view thereof;
 FIG. 22A is an enlarged fragmentary view of the portion identified in FIG. 22;

(Continued)

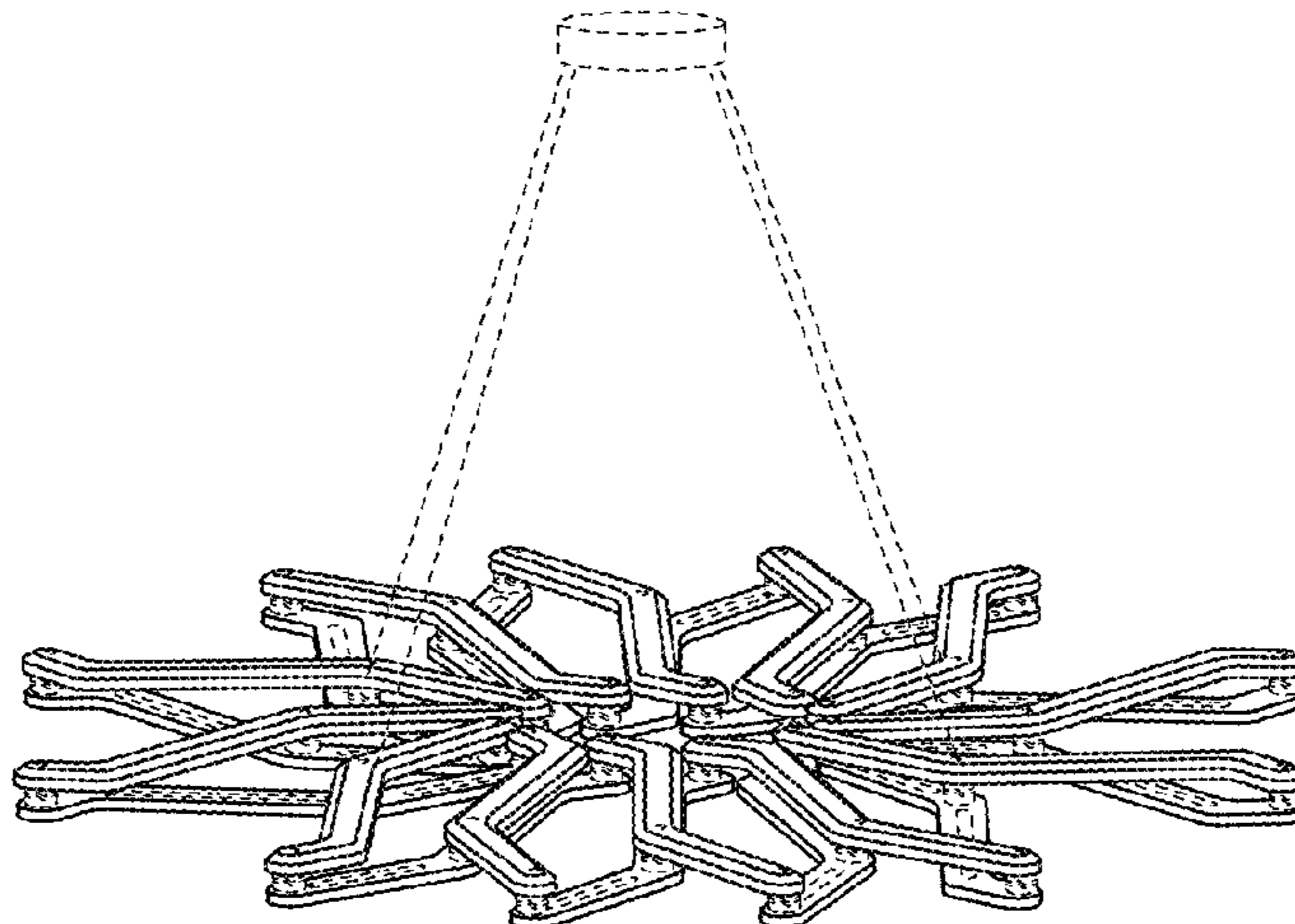

FIG. 23 is a rear view of the adjustable luminaire shown in FIG. 19;
FIG. 24 is a right-side view thereof;
FIG. 25 is a left-side view thereof;
FIG. 26 is a bottom view thereof in a half-open position; and,
FIG. 27 is a bottom view thereof in an open position.
The portions of the luminaire shown in broken lines form no part of the design.

1 Claim, 18 Drawing Sheets

(58) **Field of Classification Search**

CPC F21S 4/00; F21S 4/003; F21S 4/006; F21S 4/007; F21S 4/008; F21S 6/004; F21S 6/005; F21S 8/06; F21V 15/01; F21V 15/013; F21V 3/00; F21V 17/04; F21V 23/06; F21K 9/54; F21Y 211/10; B44C

5/00; E04B 1/3211; E04B 1/3441; A63H 17/00; A63H 17/03; A63F 9/0819

See application file for complete search history.

(56)

References Cited

U.S. PATENT DOCUMENTS

6,190,231	B1 *	2/2001	Hoberman	A63F 9/0819 446/487
7,100,333	B2 *	9/2006	Hoberman	E04B 1/3211 446/487
D636,927	S *	4/2011	Lin	D26/138
D637,344	S *	5/2011	Baker	D26/138
D761,991	S *	7/2016	Clark	F21V 1/22 D26/73
D807,560	S *	1/2018	Jones	D26/81
D865,275	S *	10/2019	Yu	D26/155
D869,745	S *	12/2019	Sonneman	D26/138

* cited by examiner

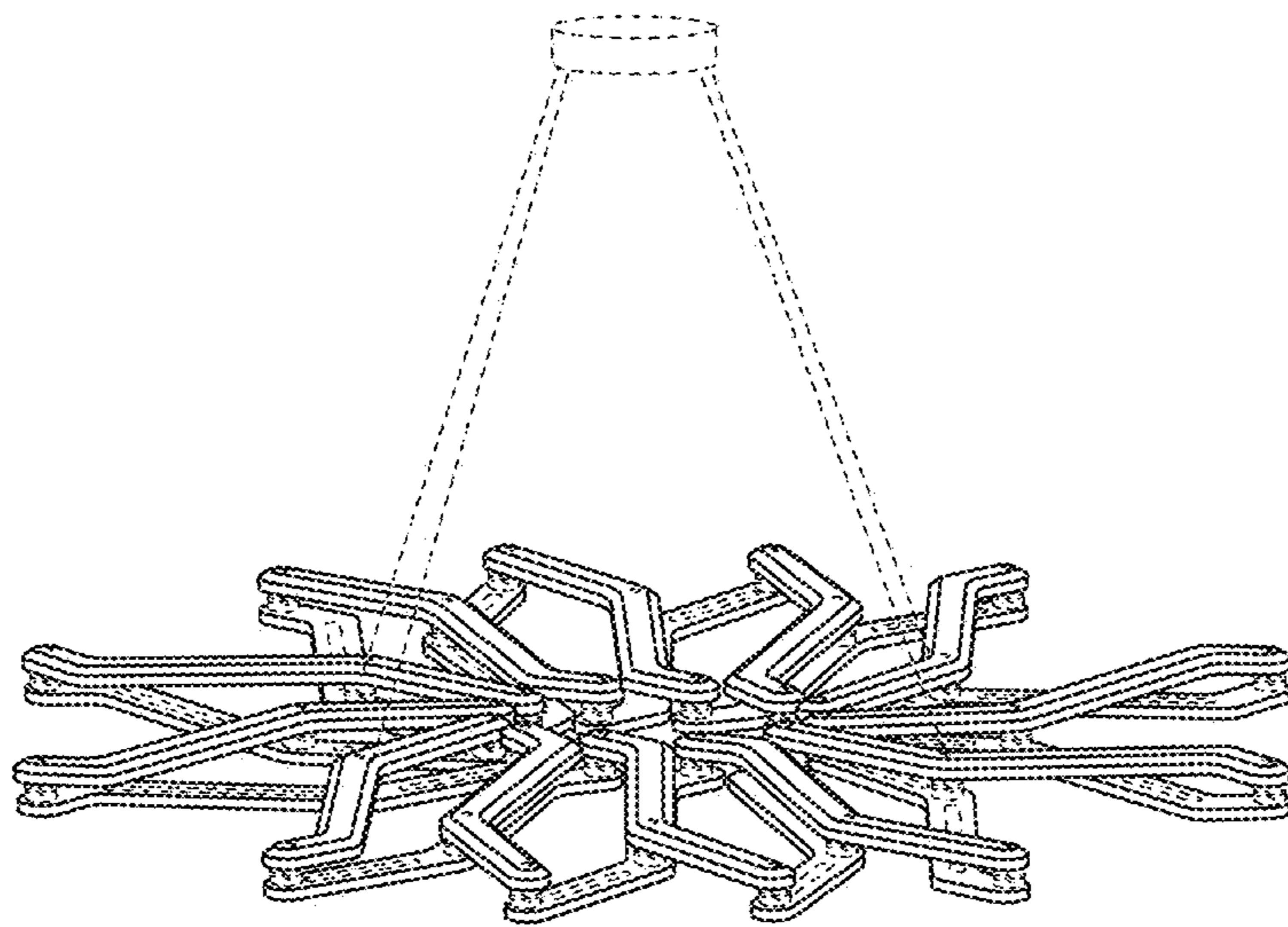

FIG. 1

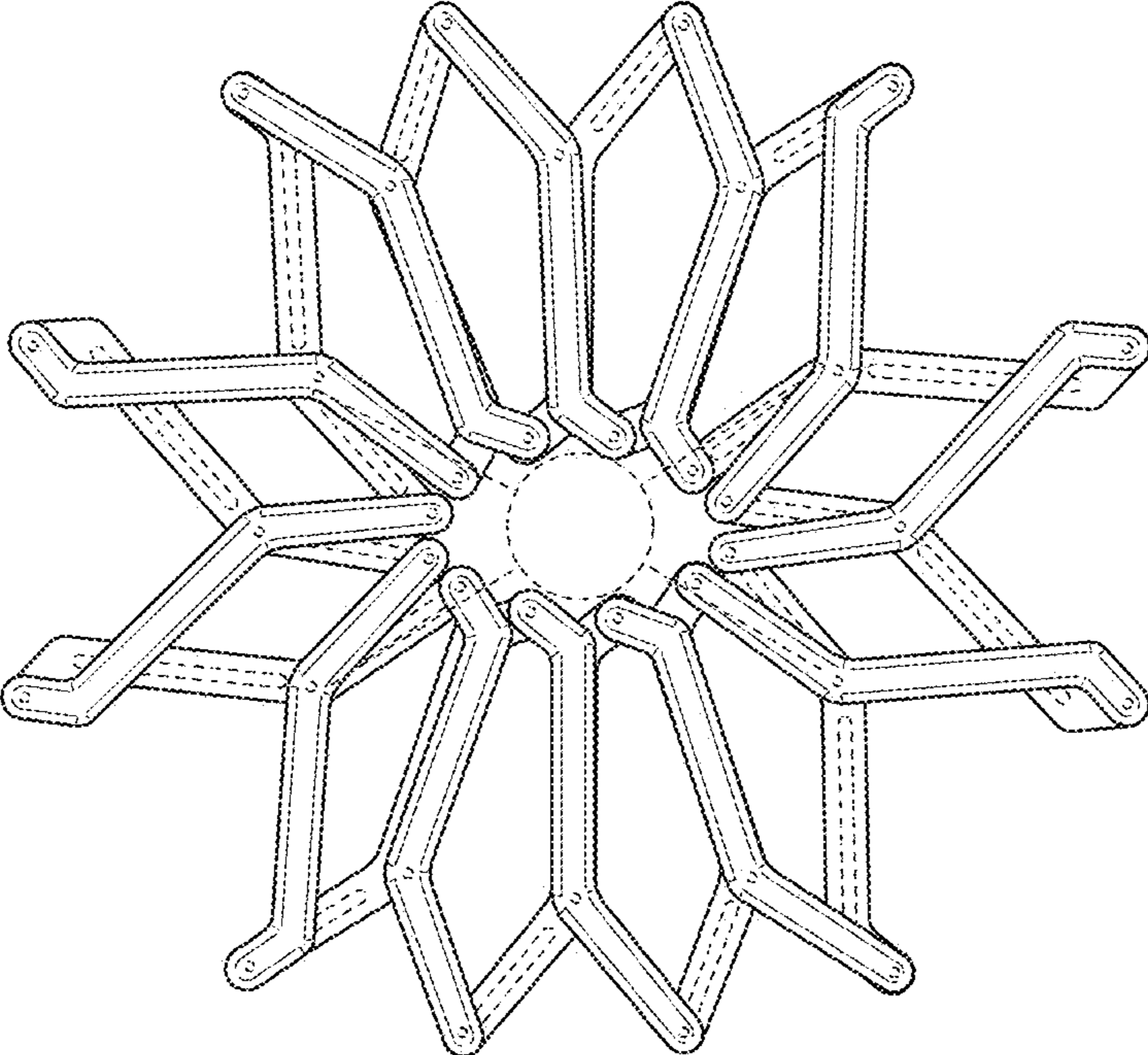

FIG. 2

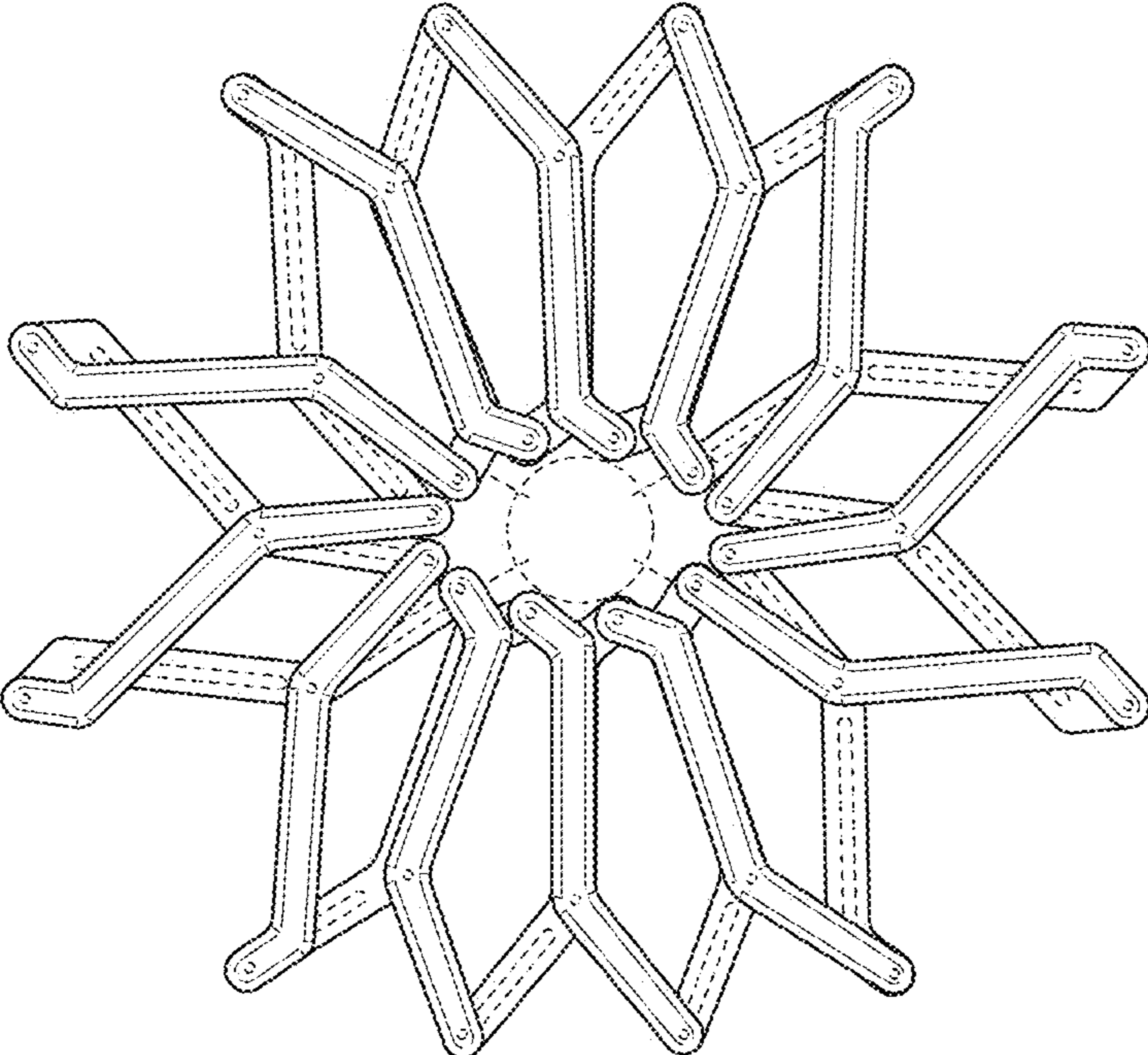

FIG. 3

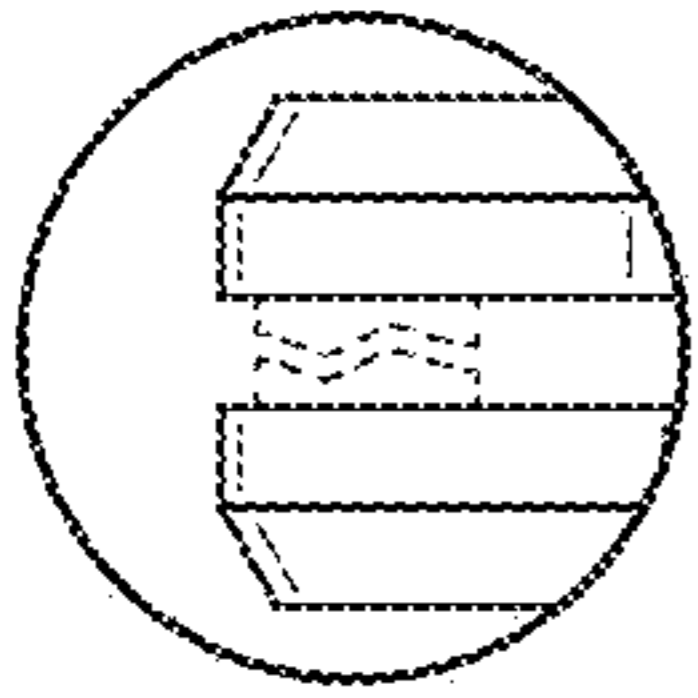

FIG. 4A

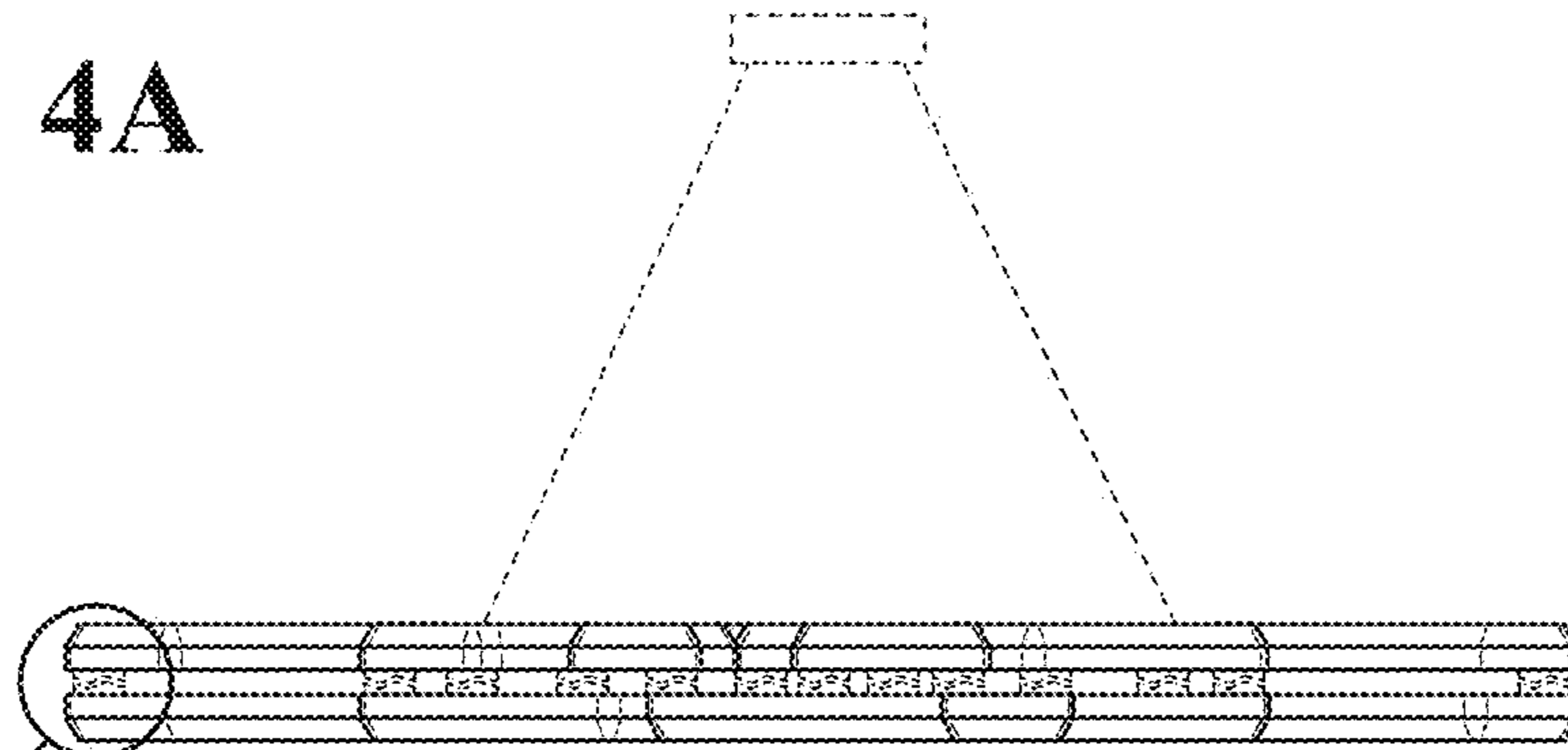

FIG. 4

FIG. 4A

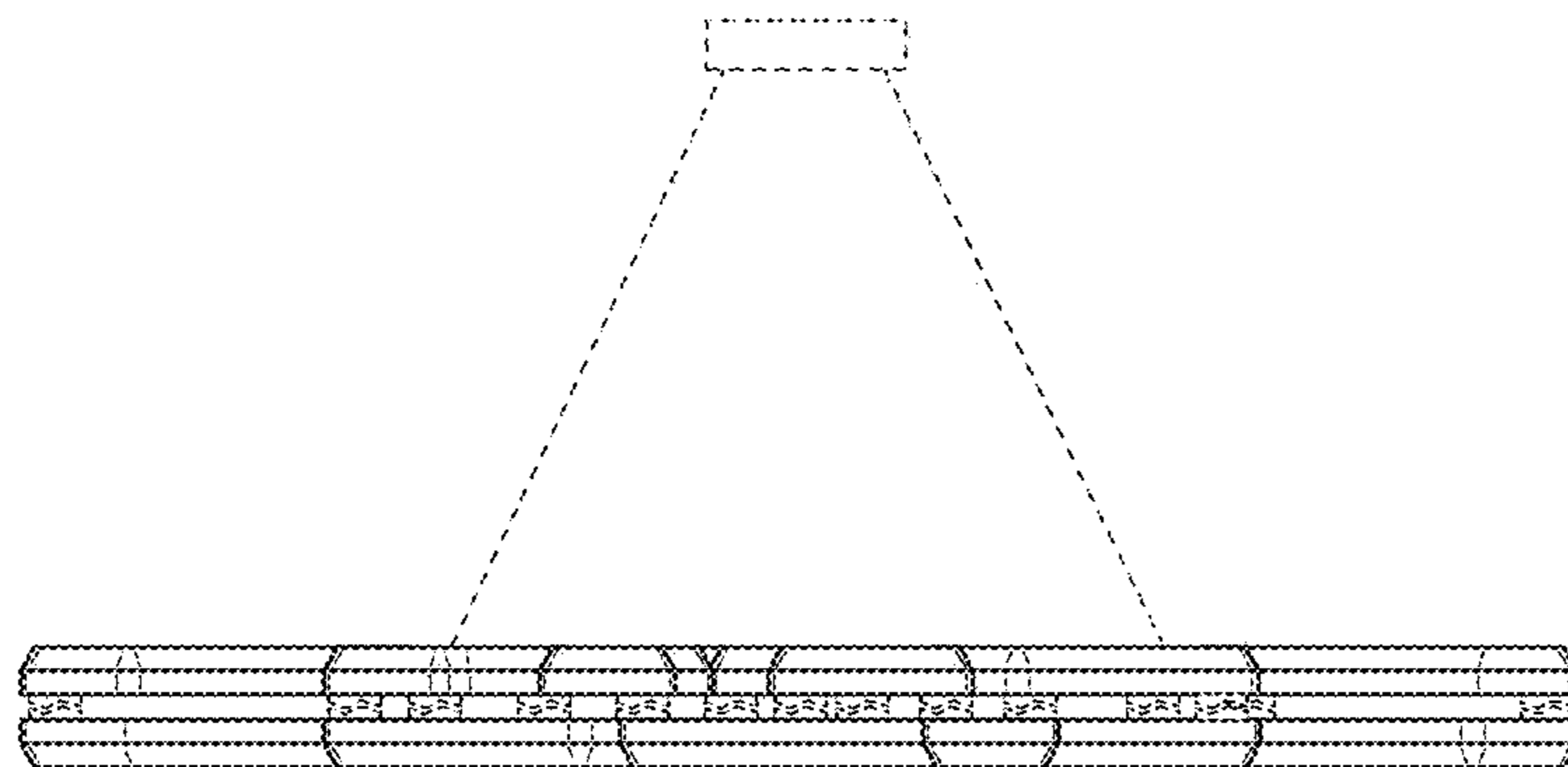

FIG. 5

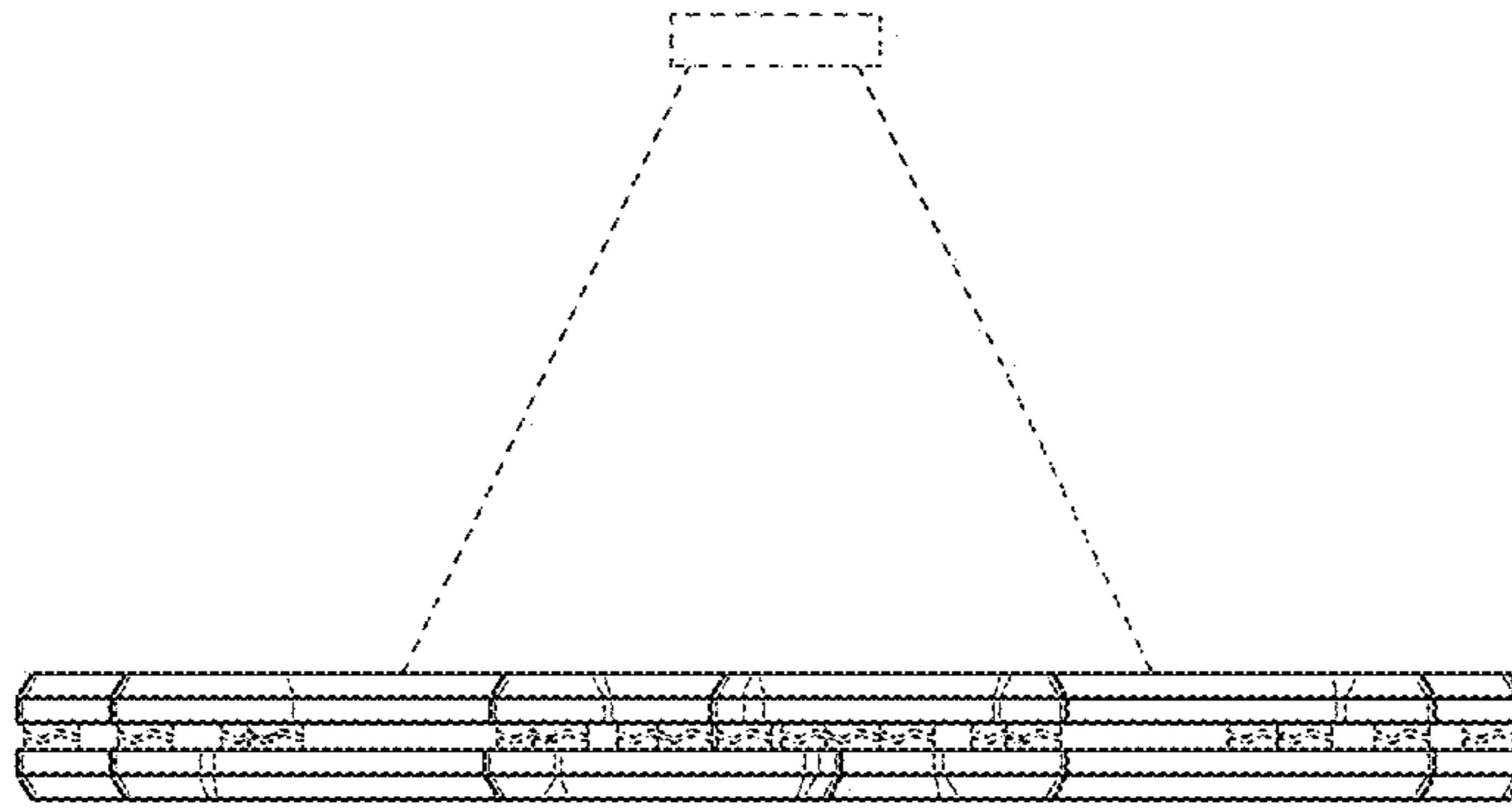

FIG. 6

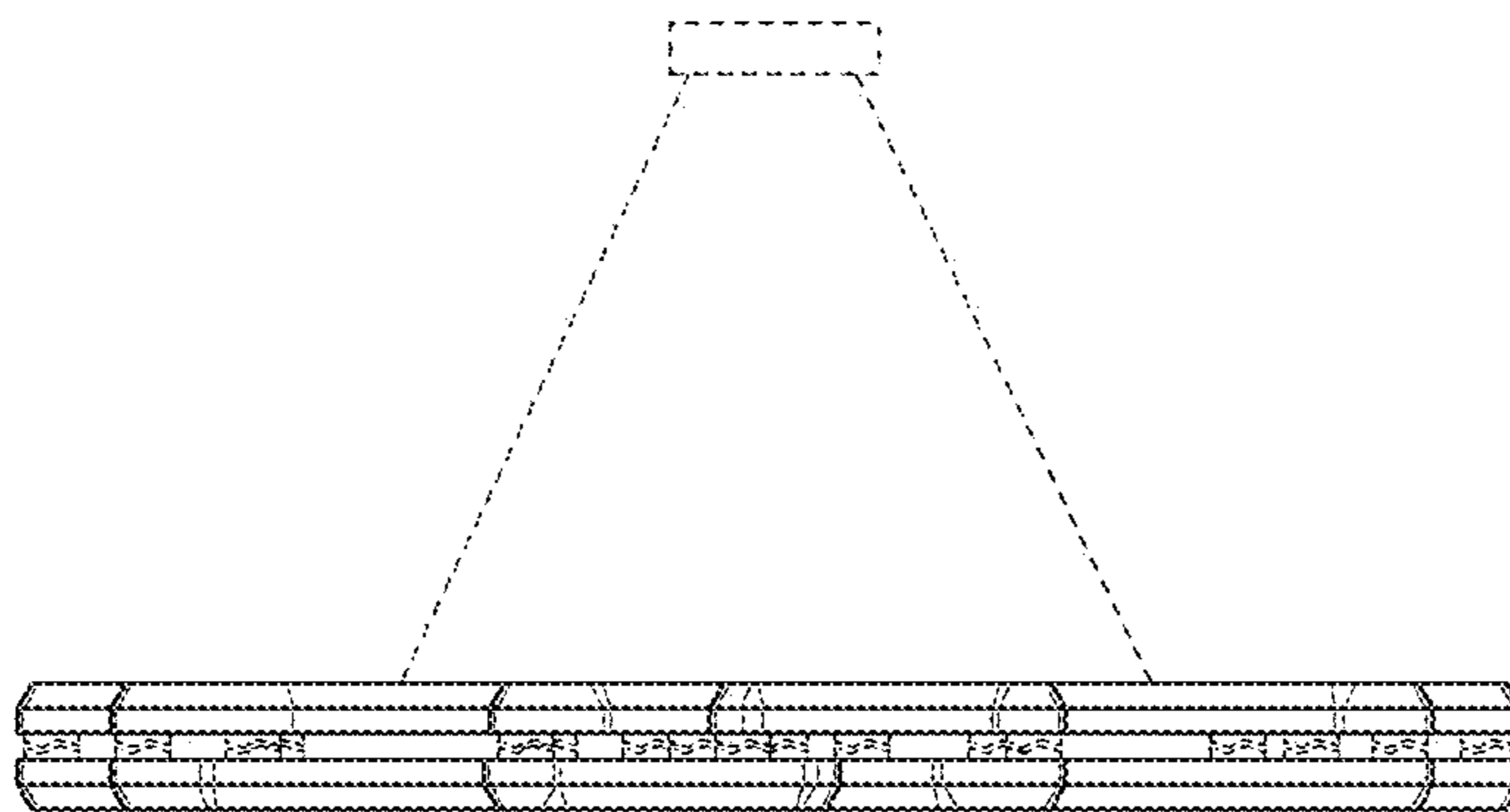

FIG. 7

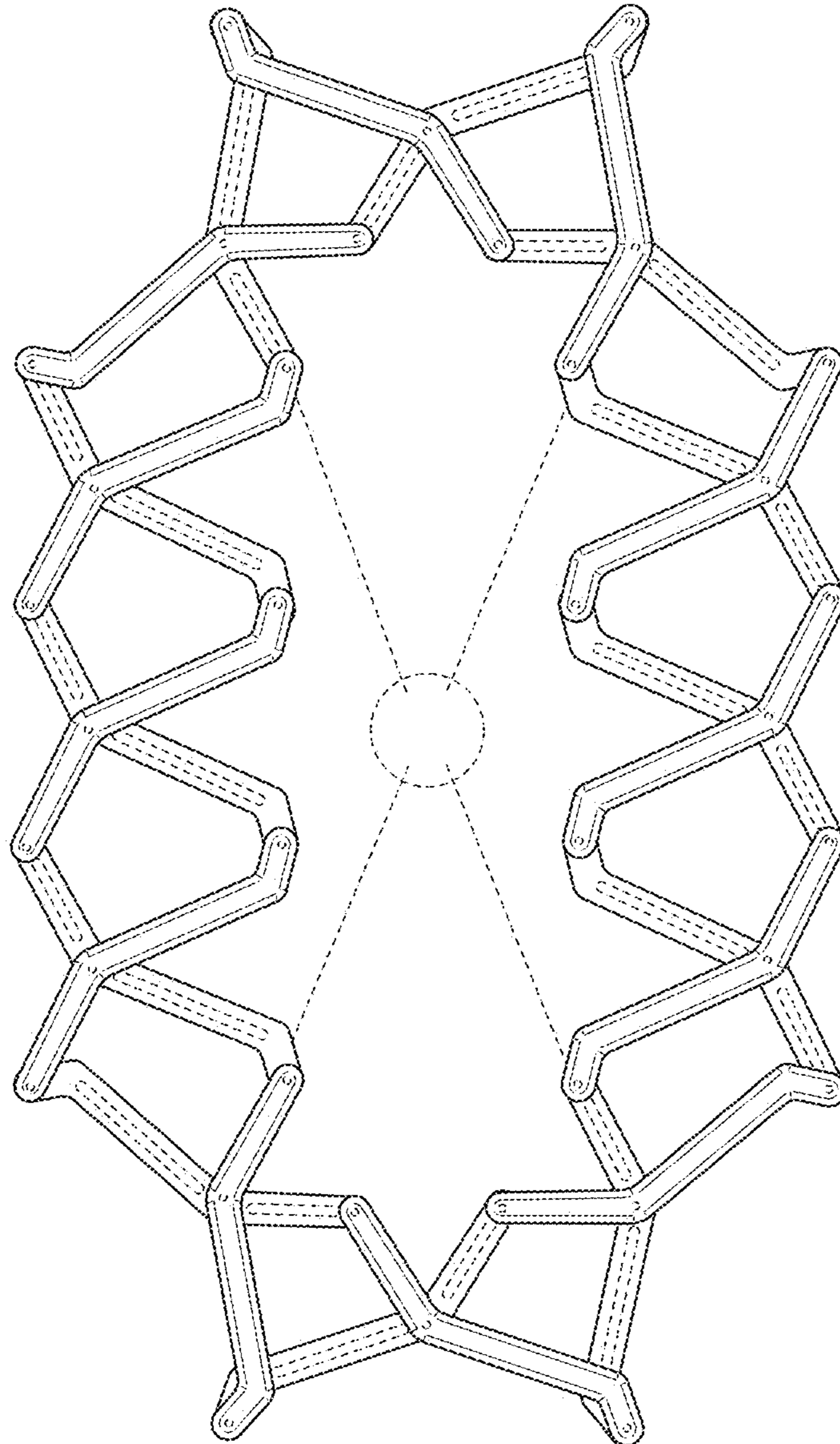

FIG. 8

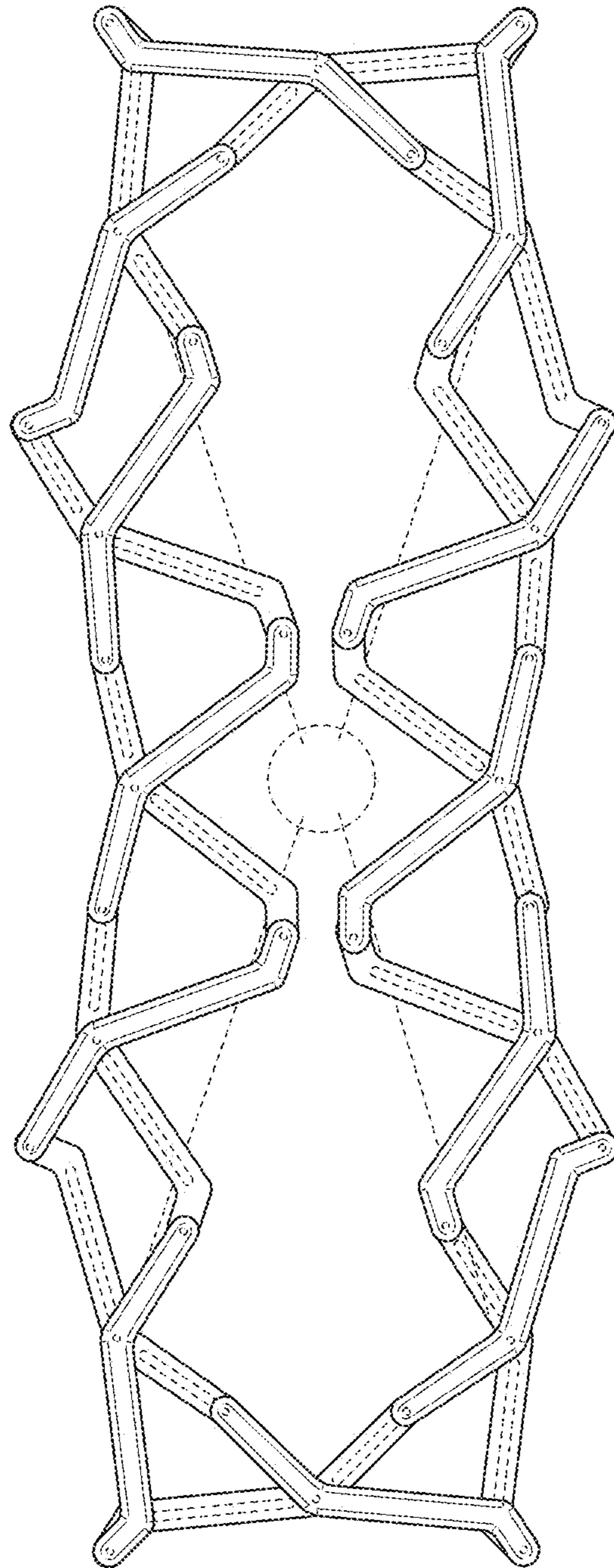

FIG. 9

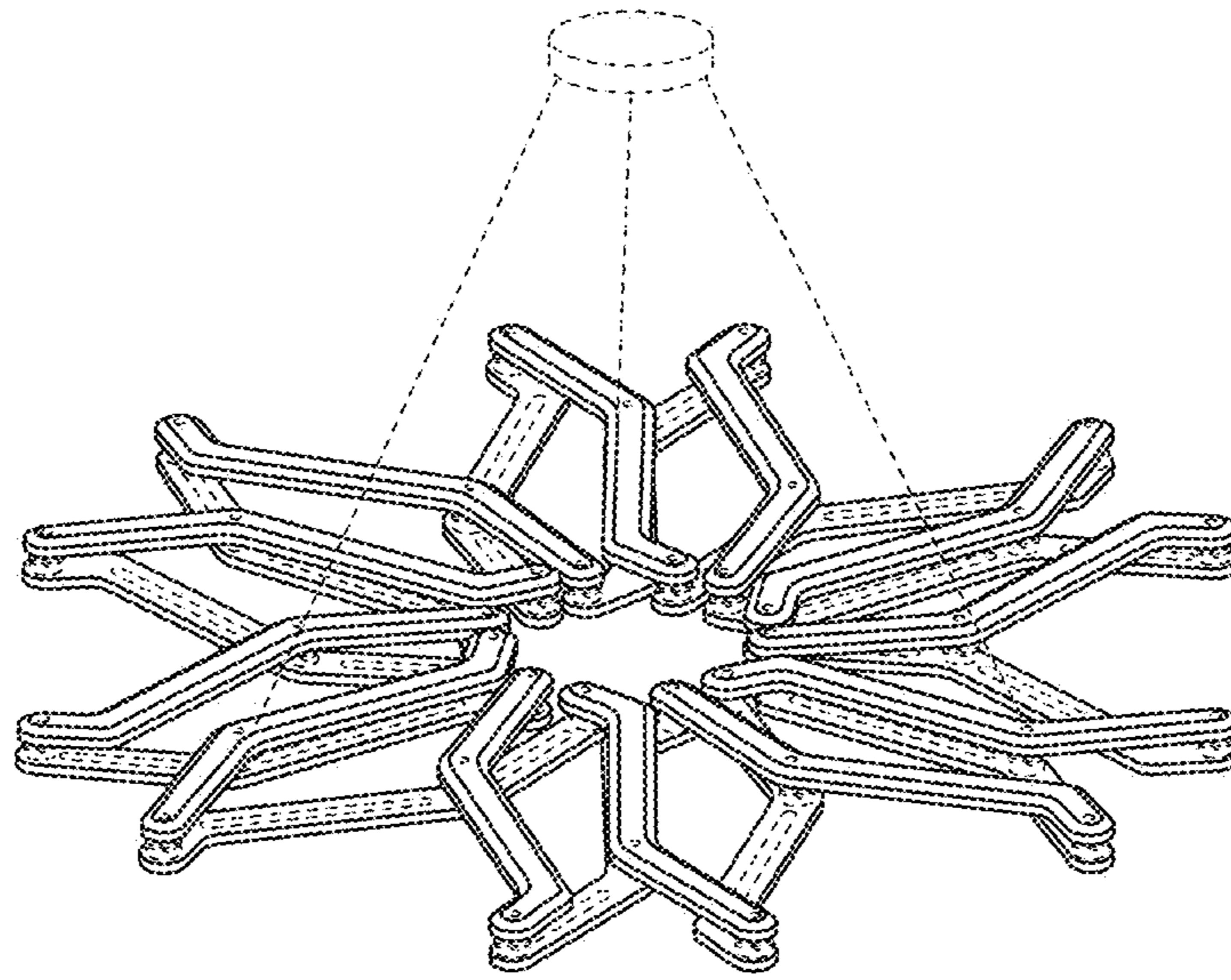

FIG. 10

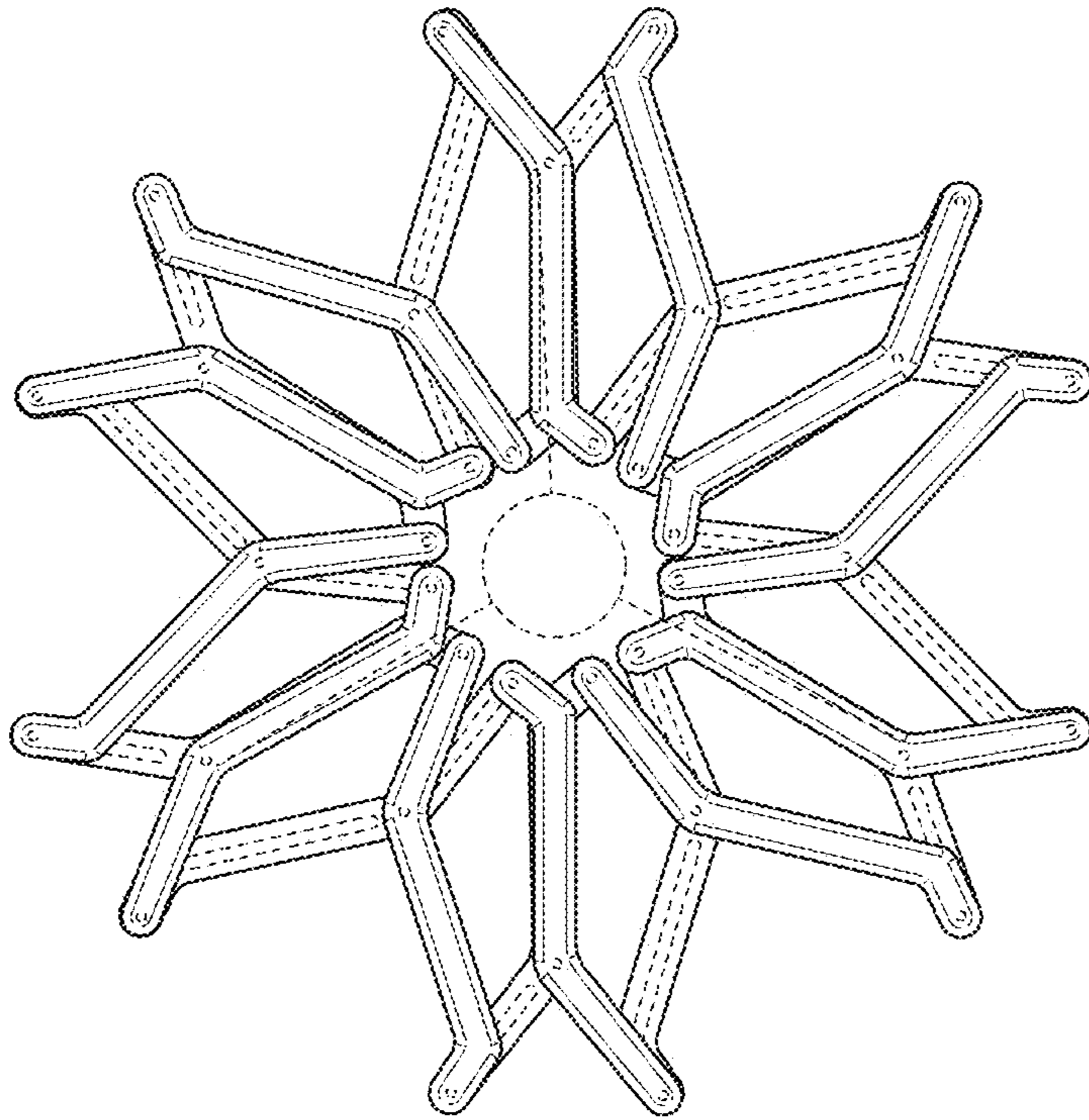

FIG. 11

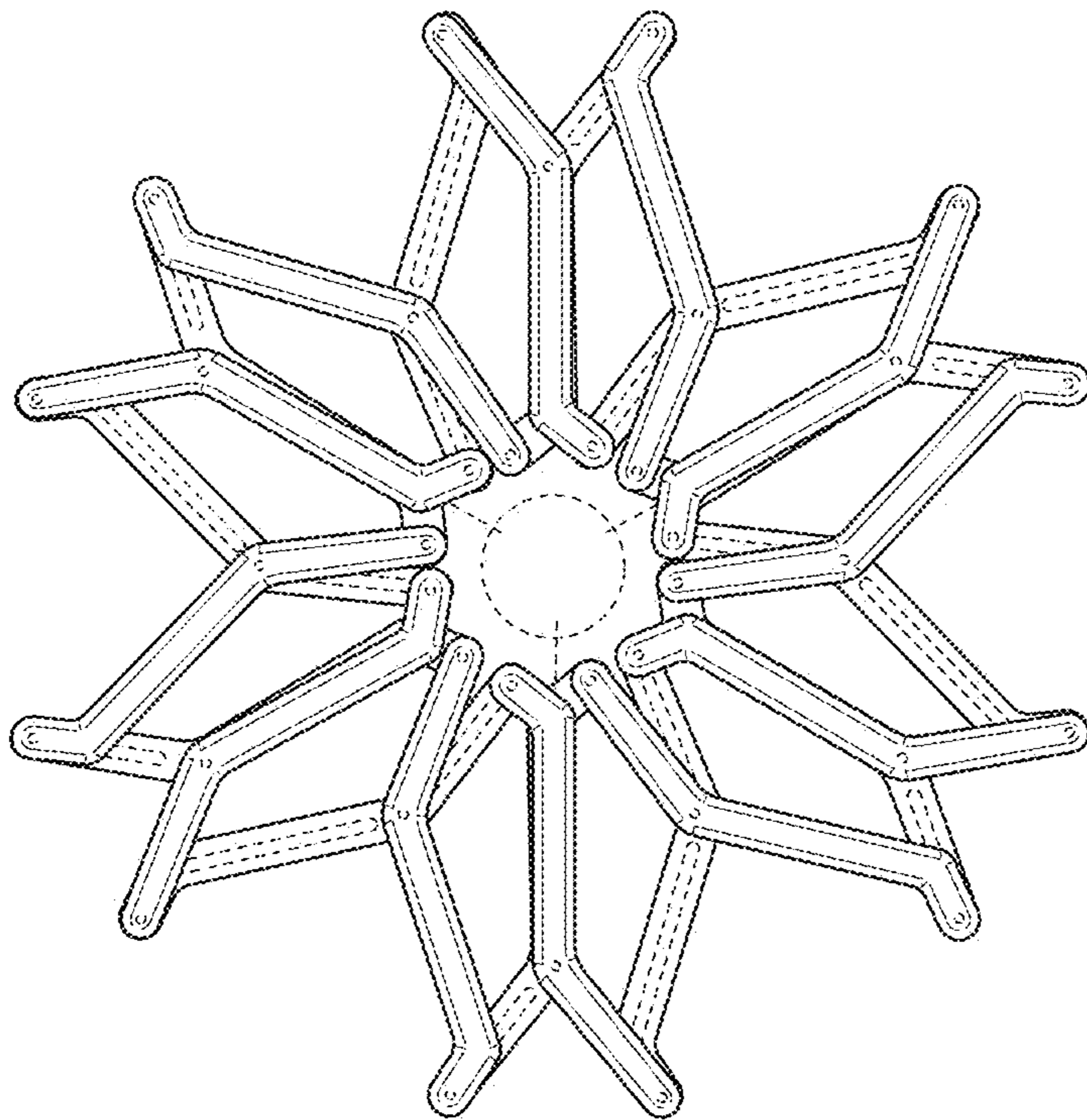

FIG. 12

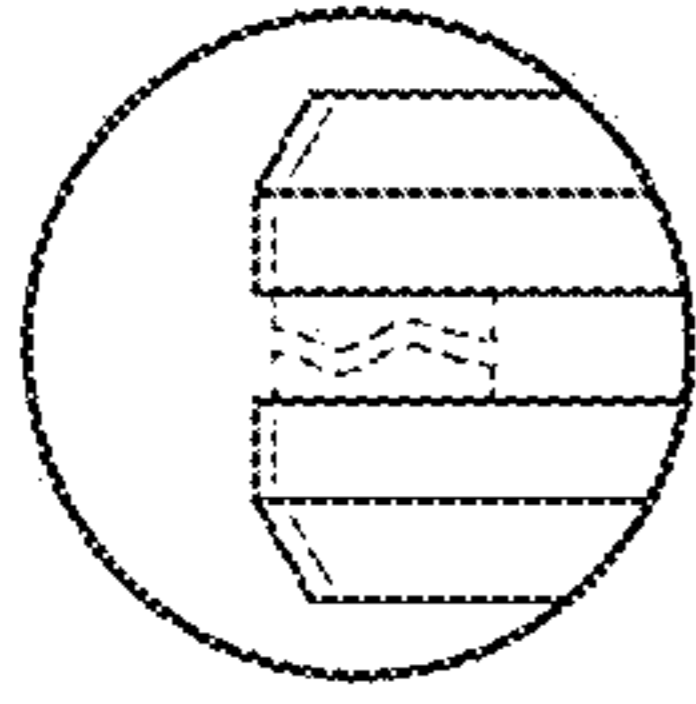

FIG. 13A

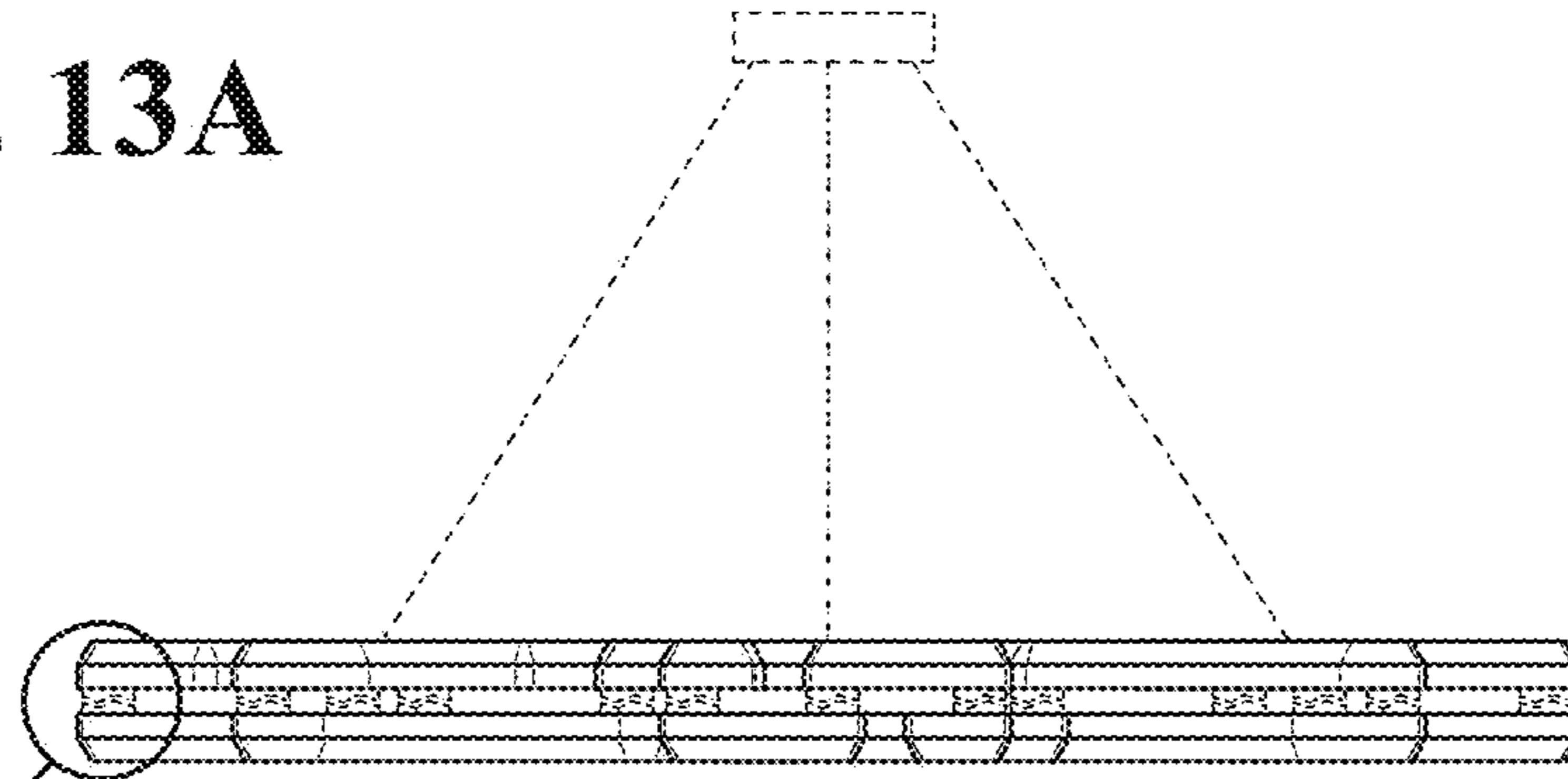

FIG. 13

FIG. 13A

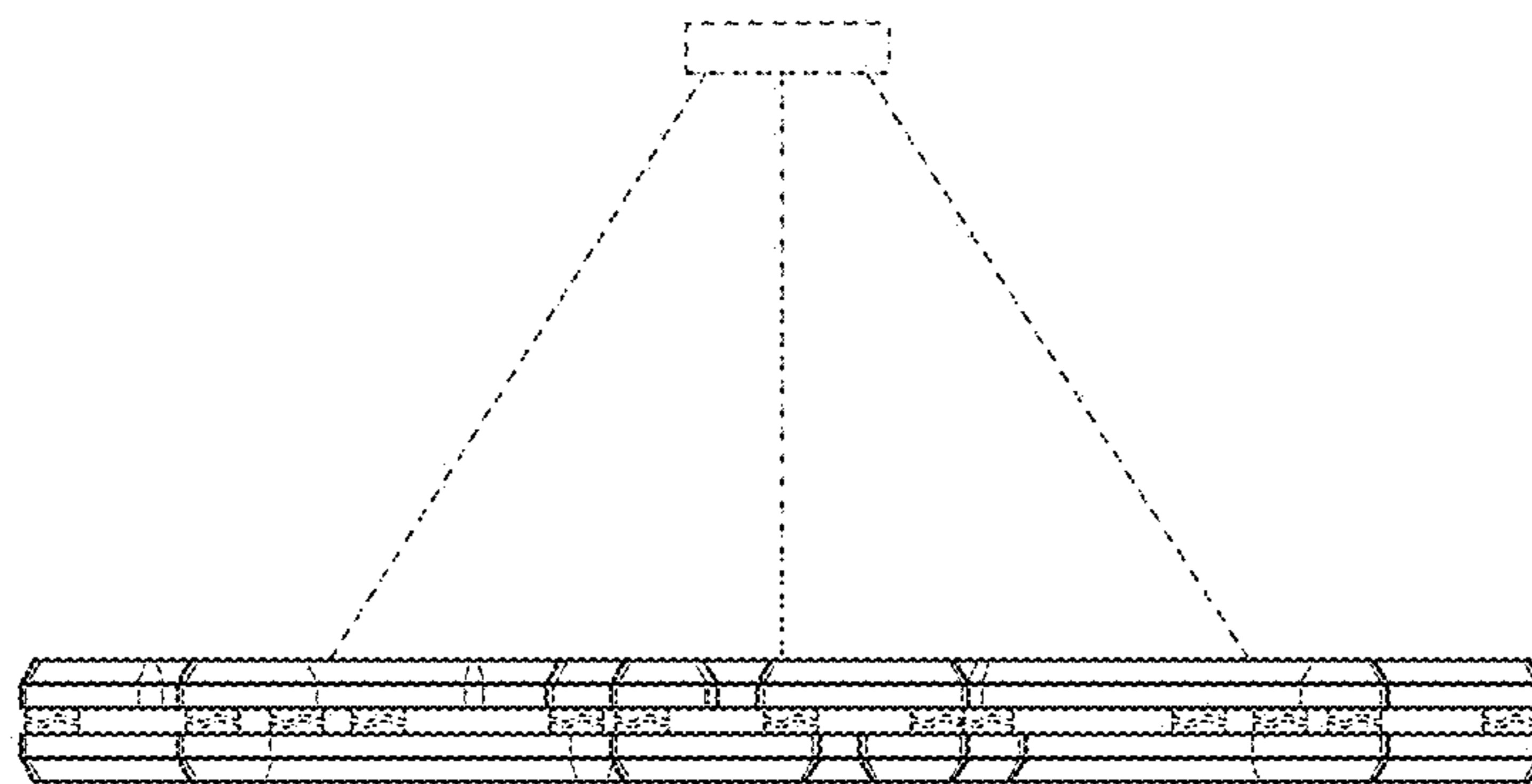

FIG. 14

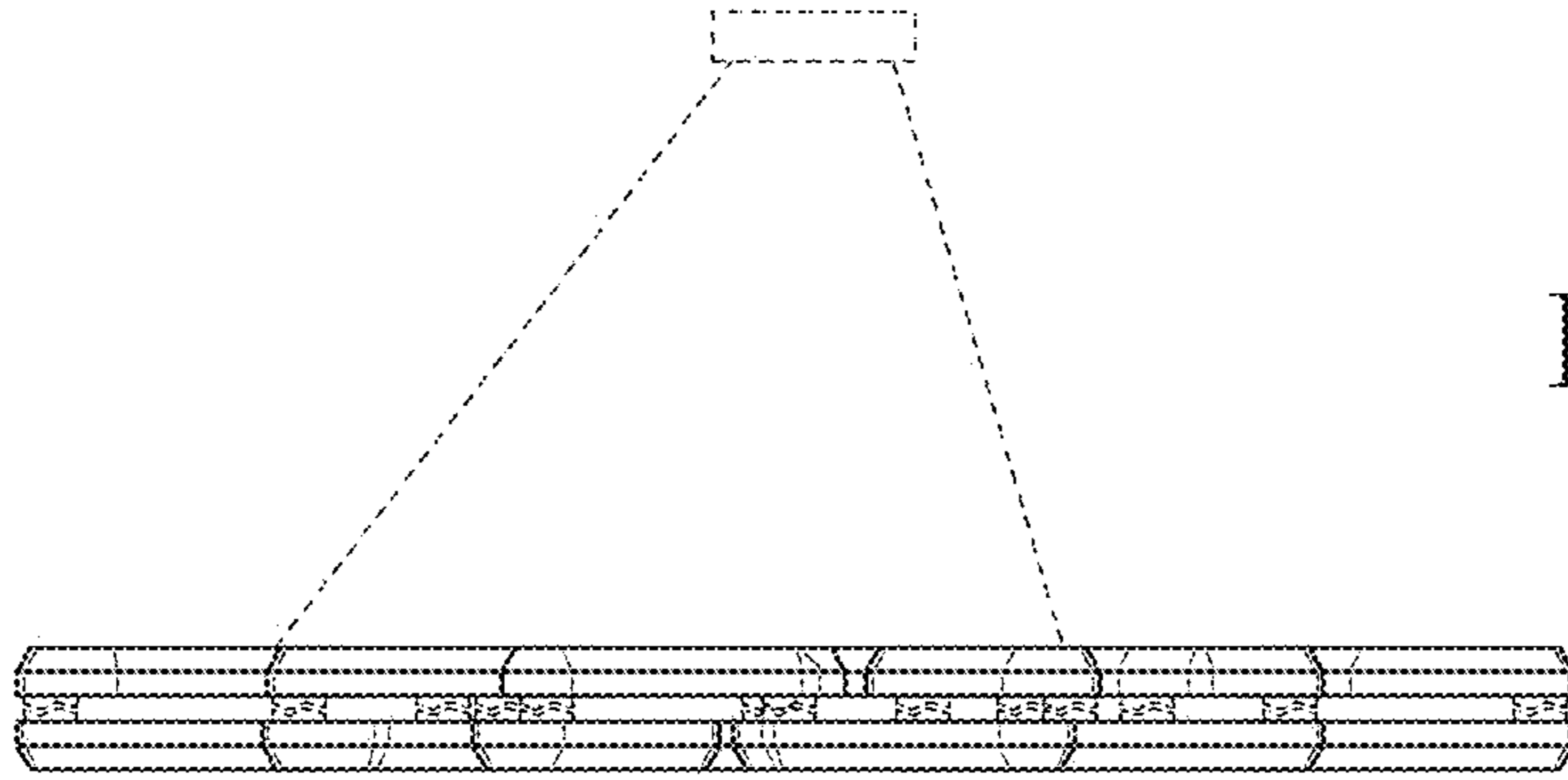

FIG. 15

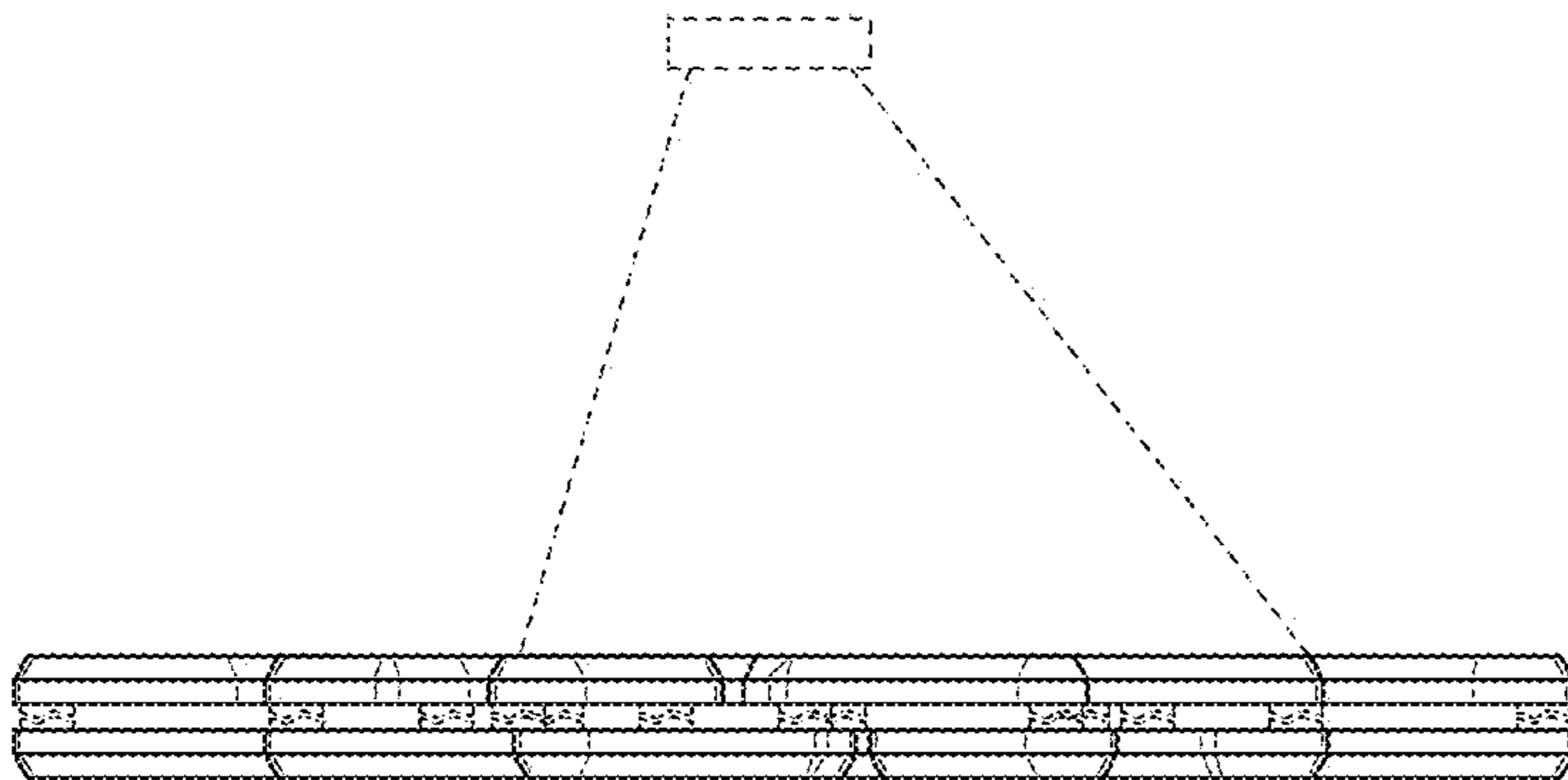

FIG. 16

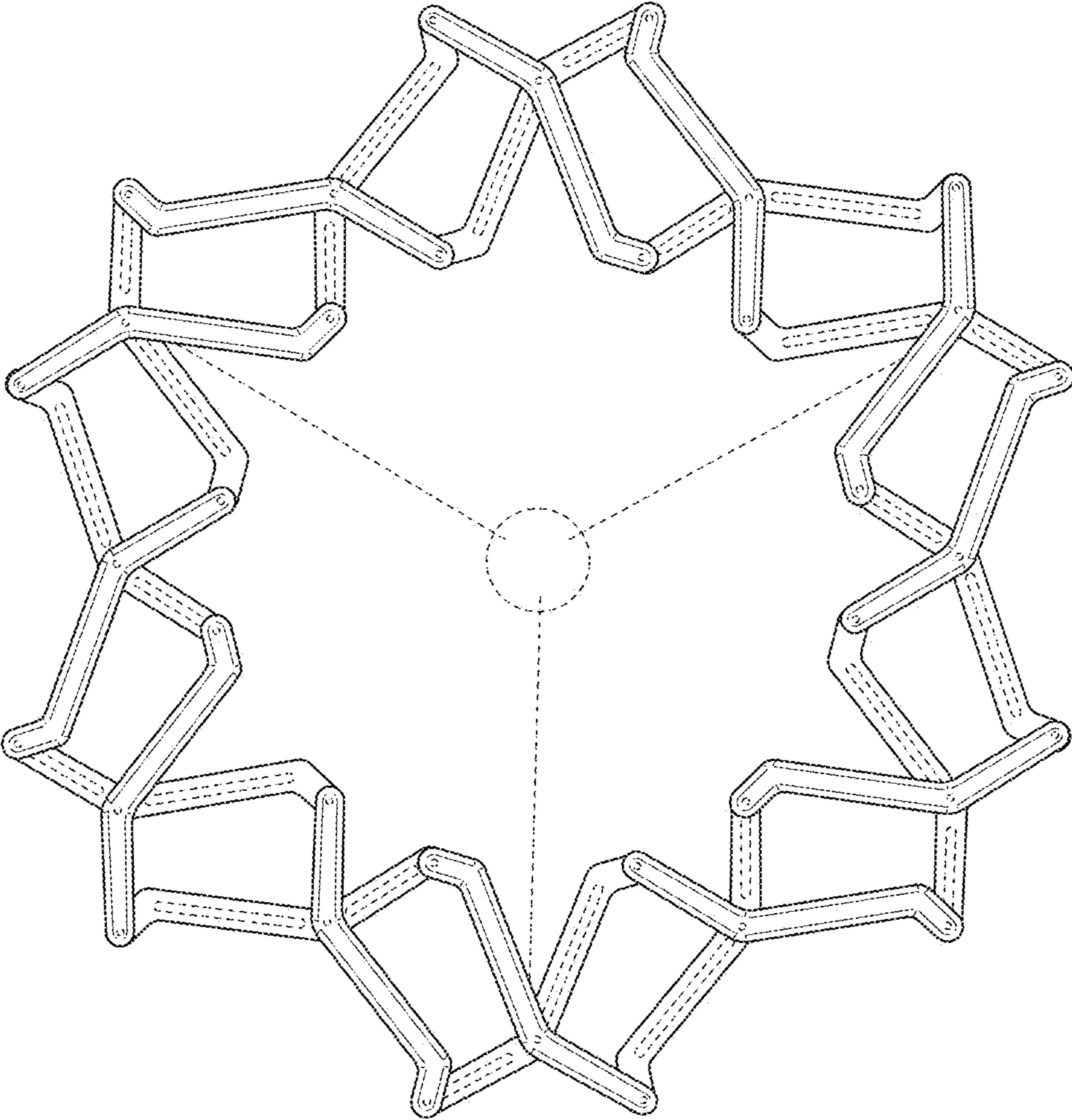

FIG. 17

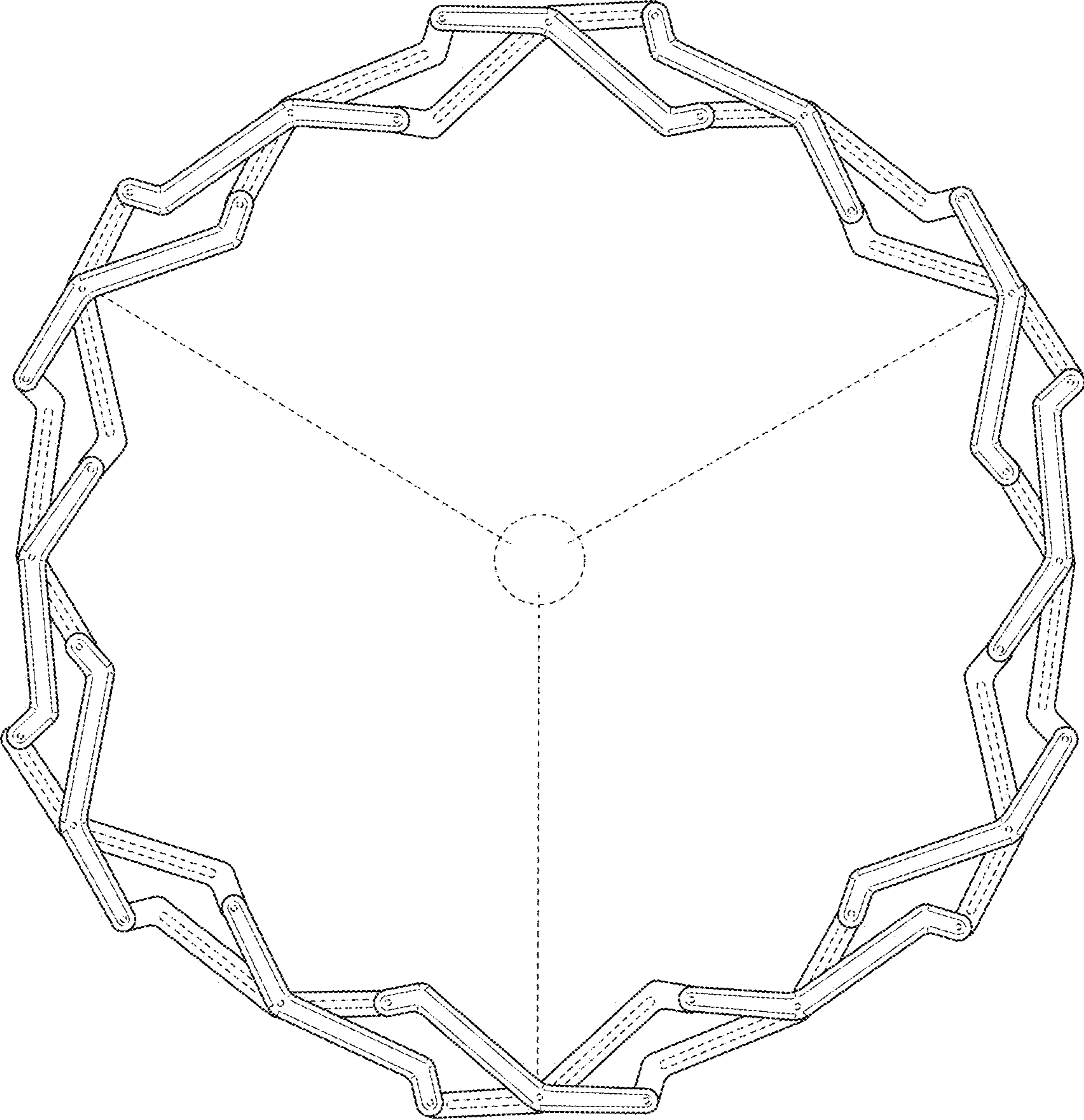

FIG. 18

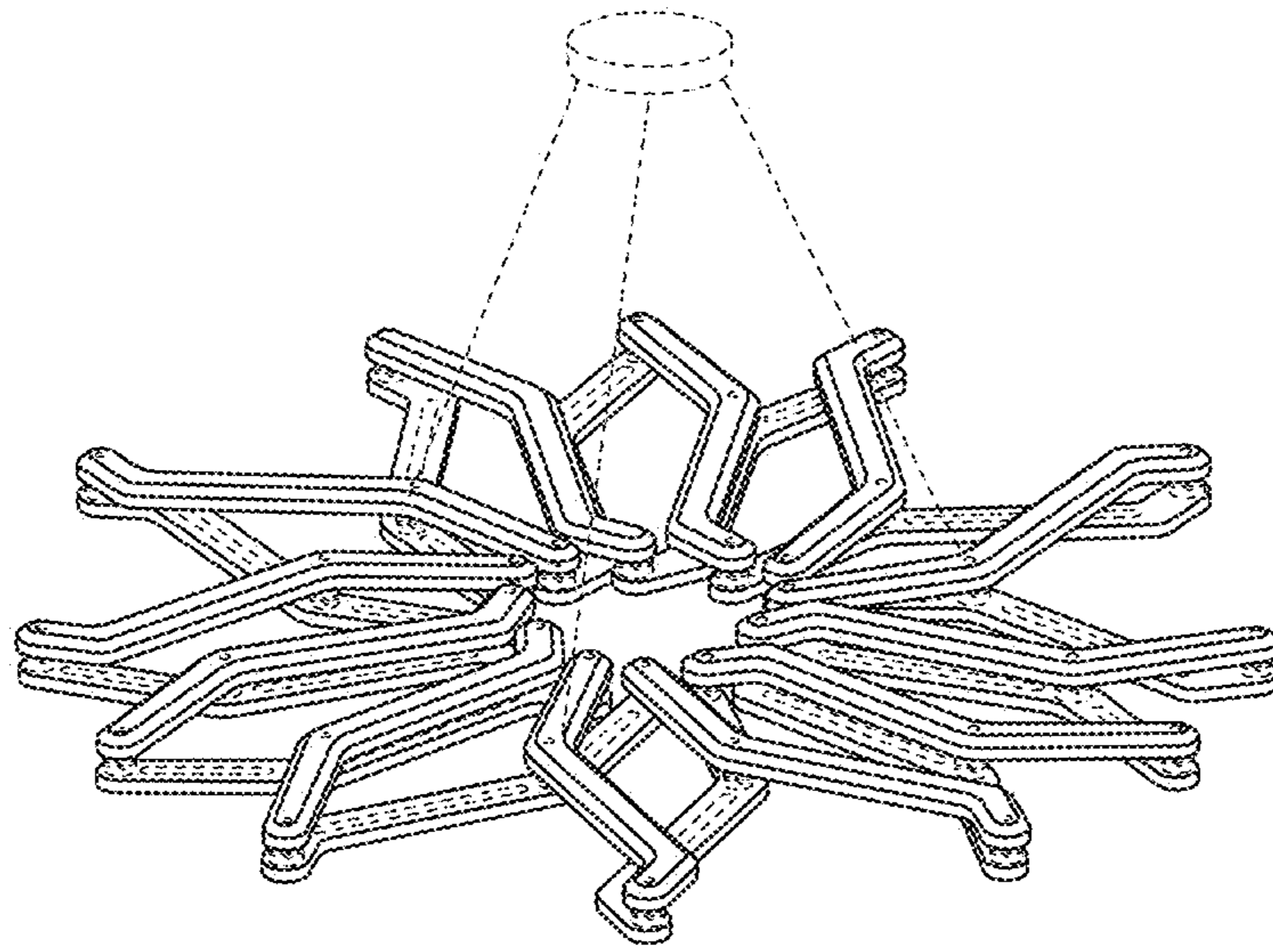

FIG. 19

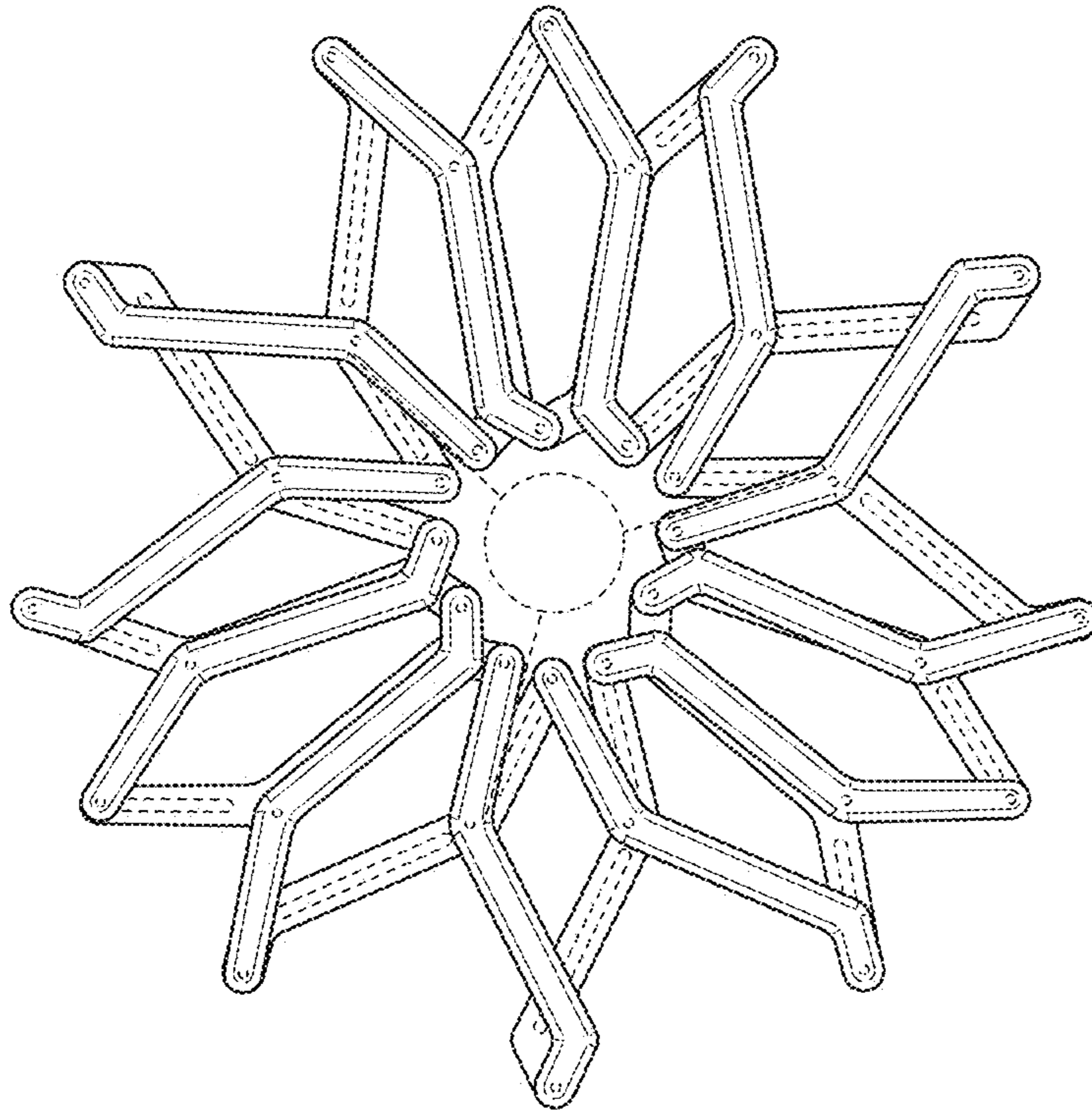

FIG. 20

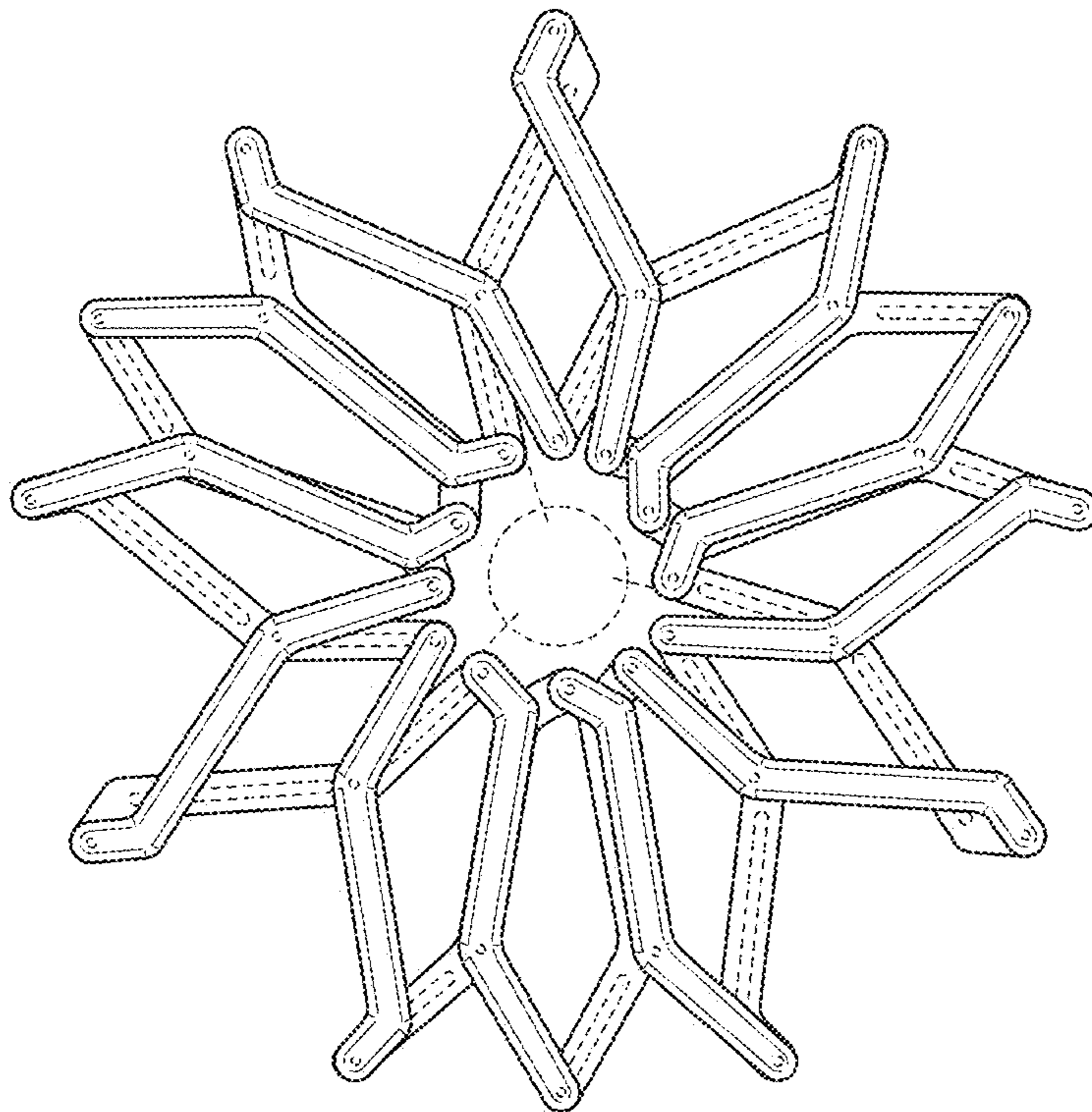

FIG. 21

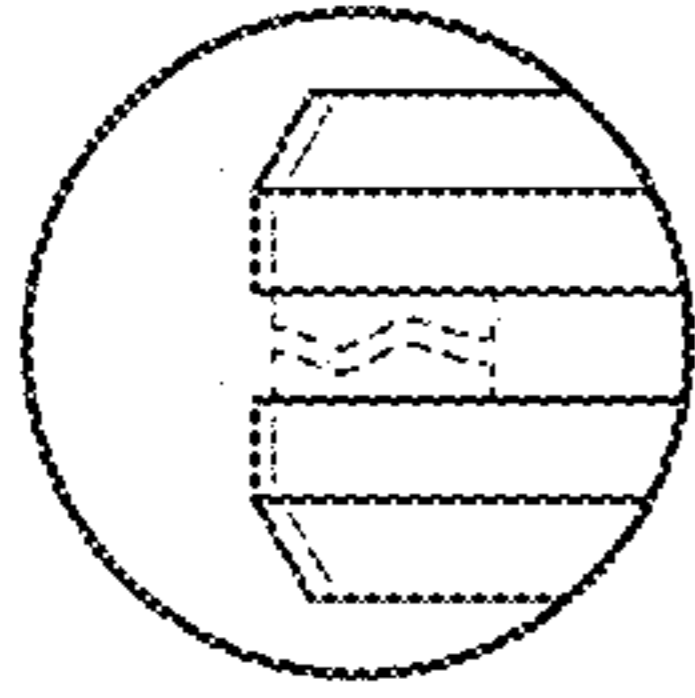

FIG. 22A

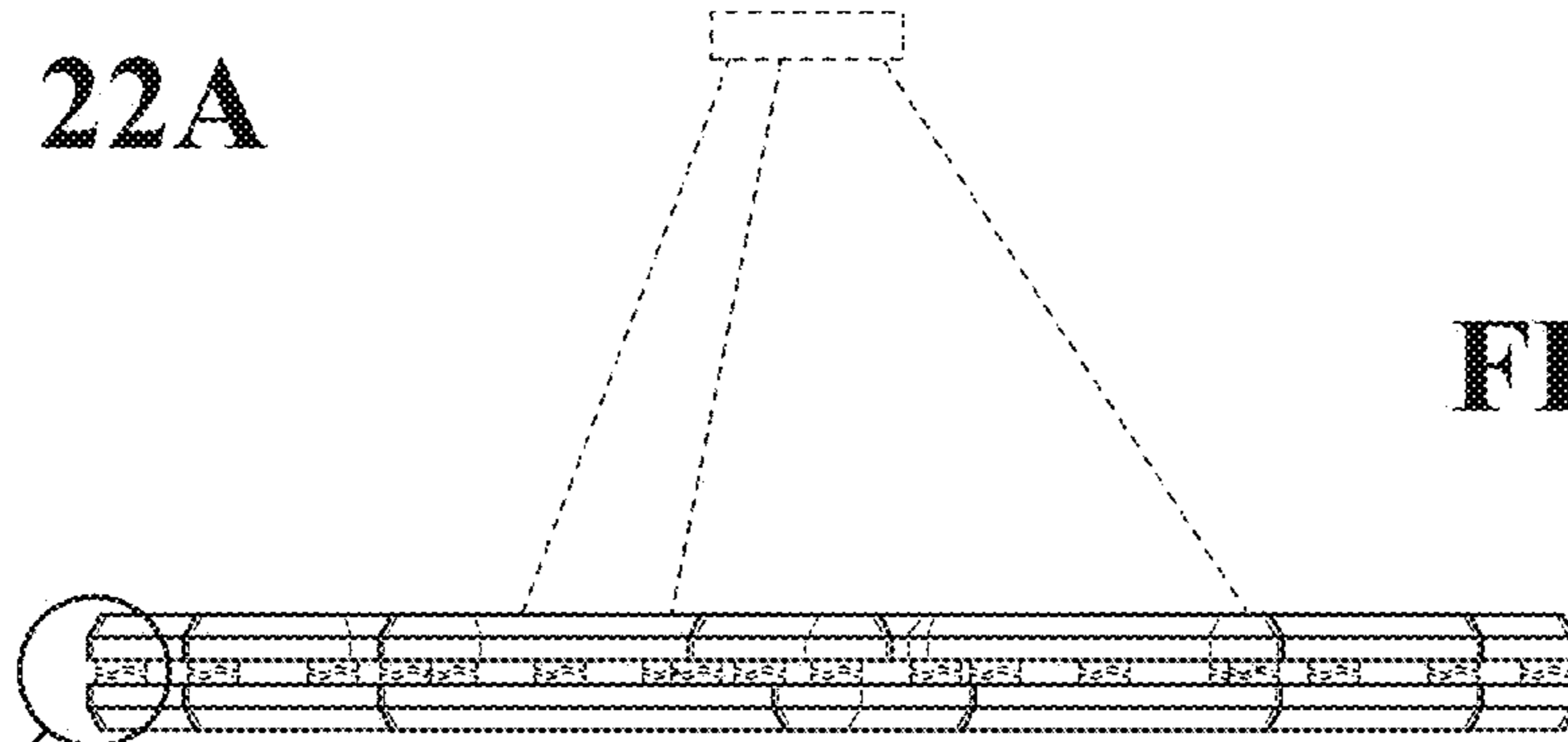

FIG. 22

FIG. 22A

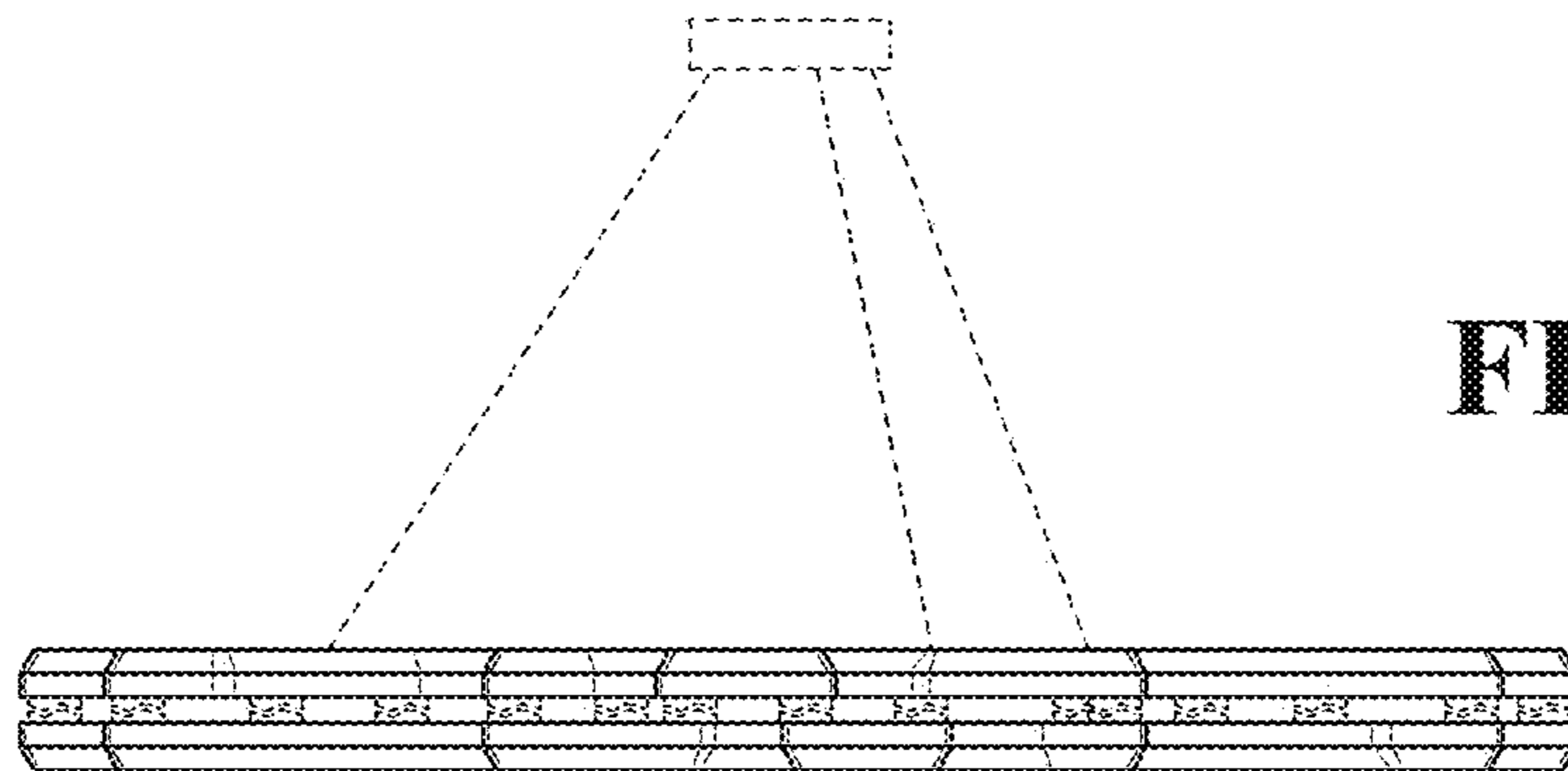

FIG. 23

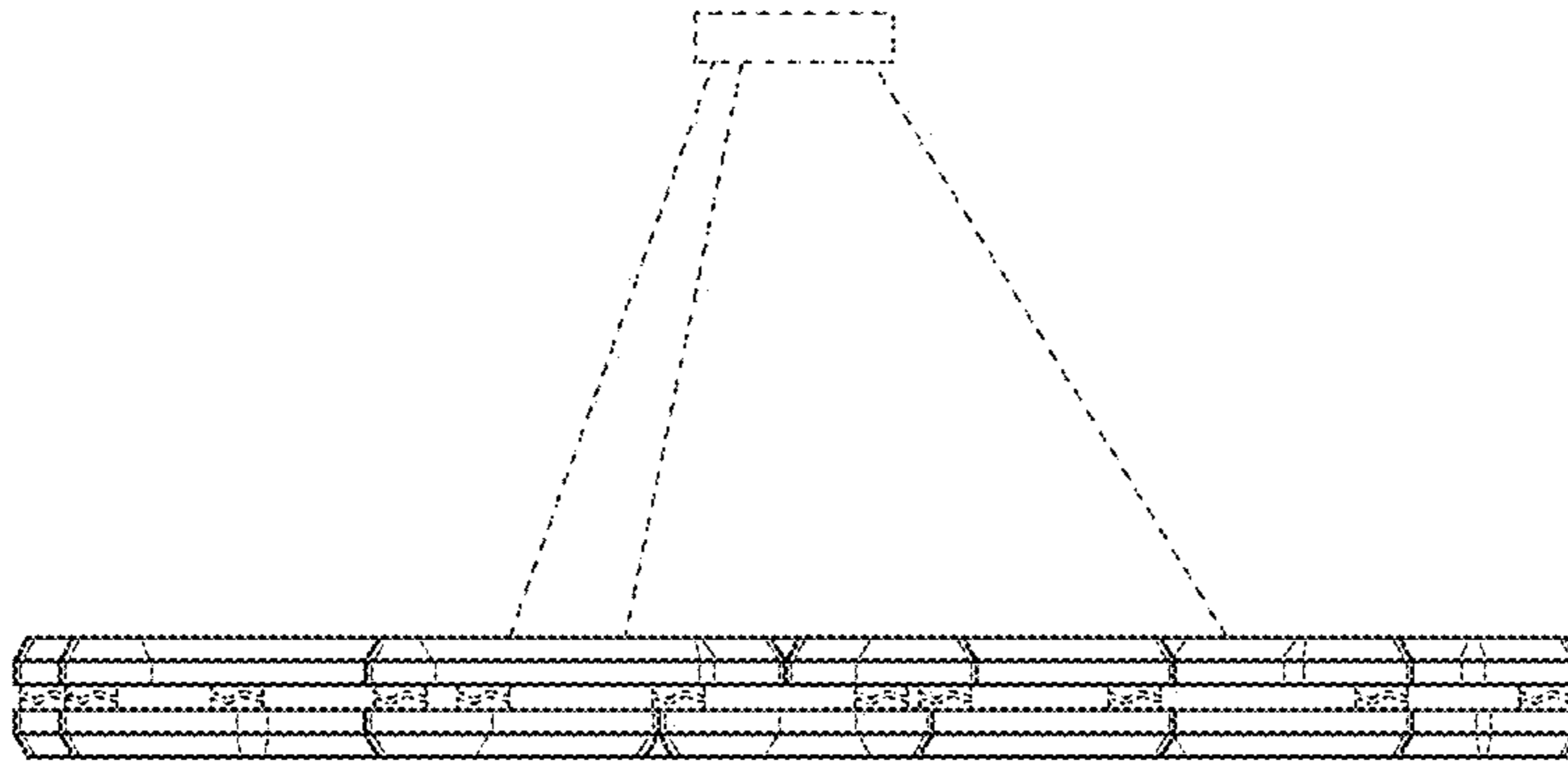

FIG. 24

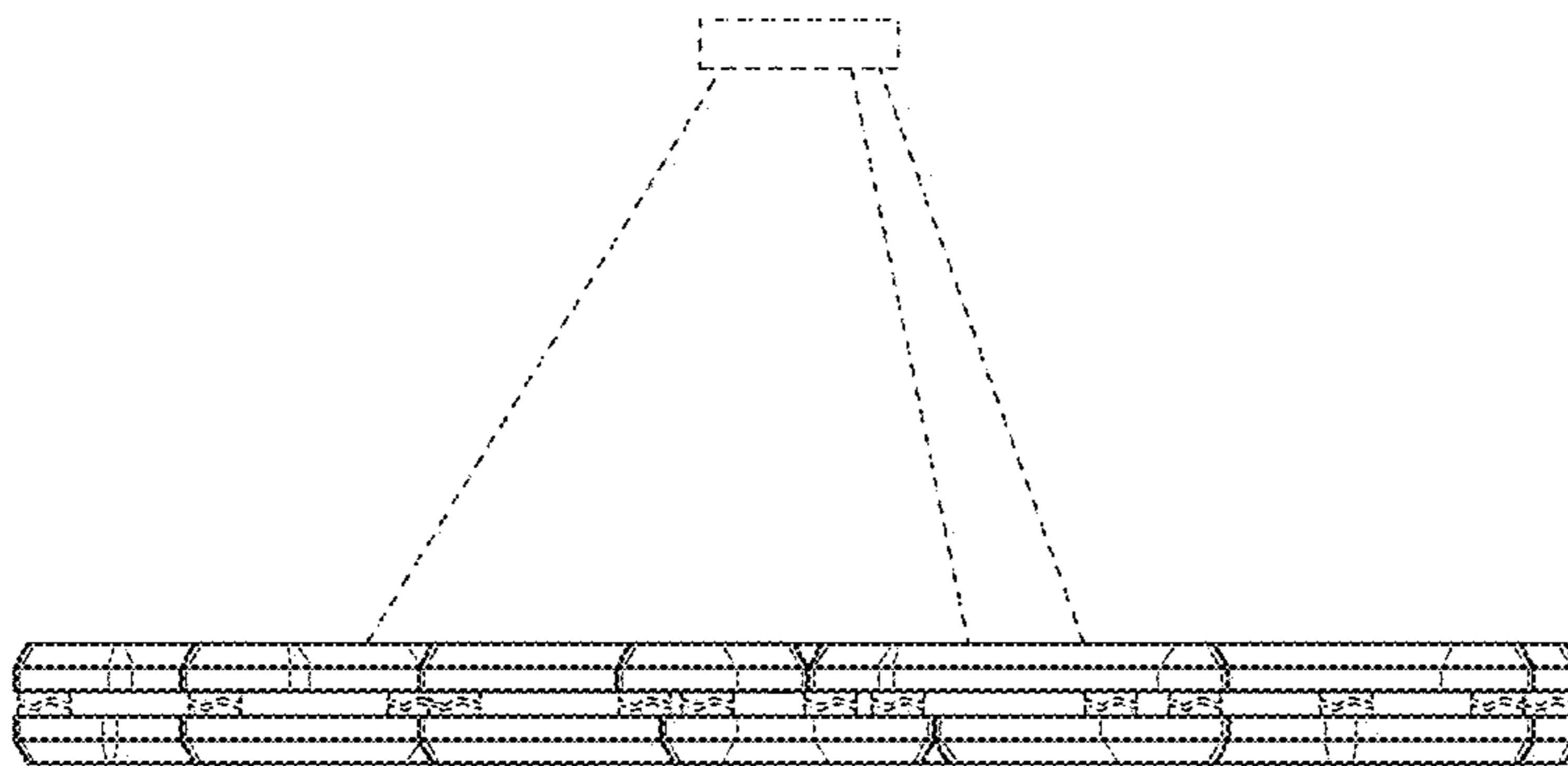

FIG. 25

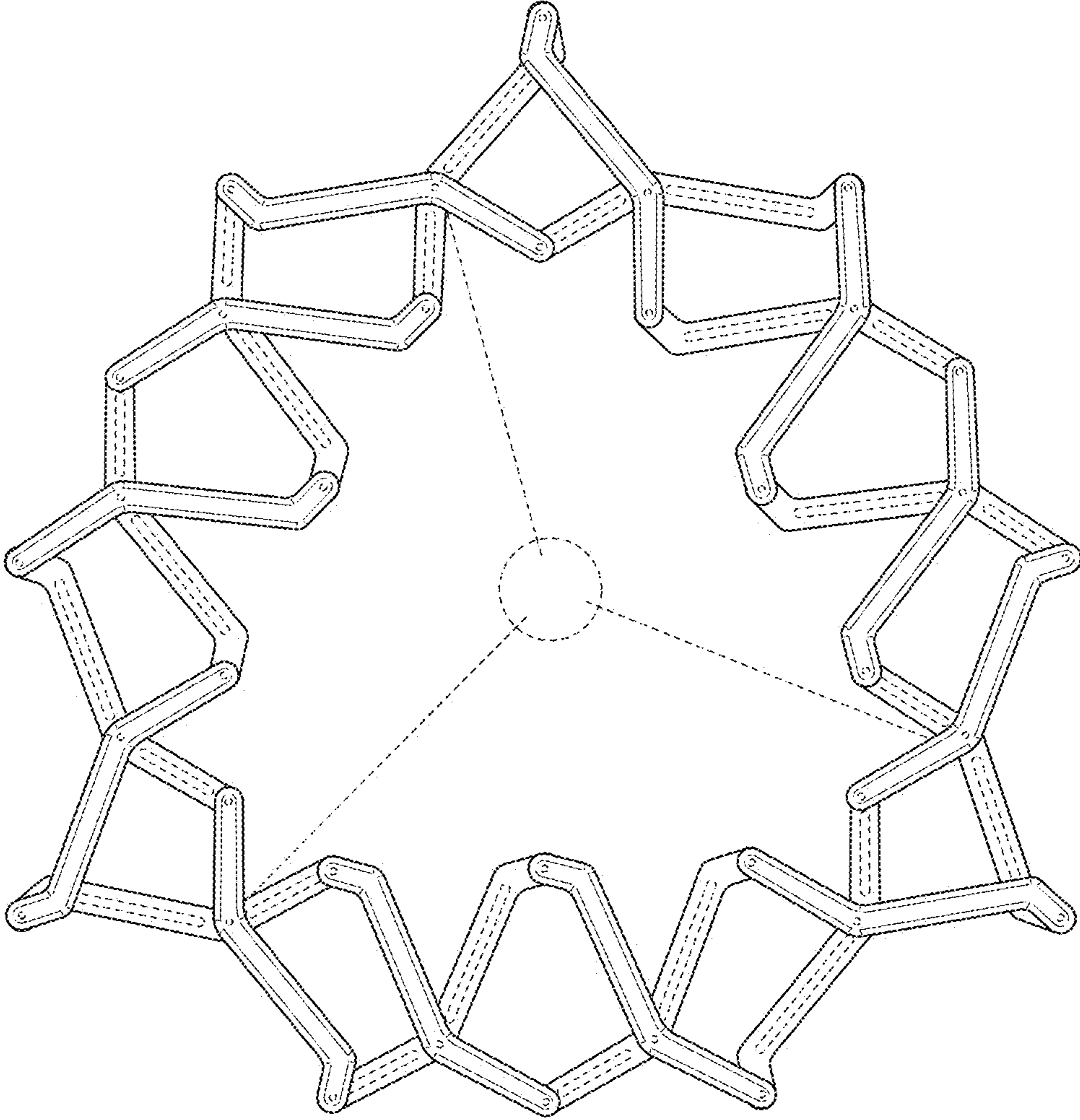

FIG. 26

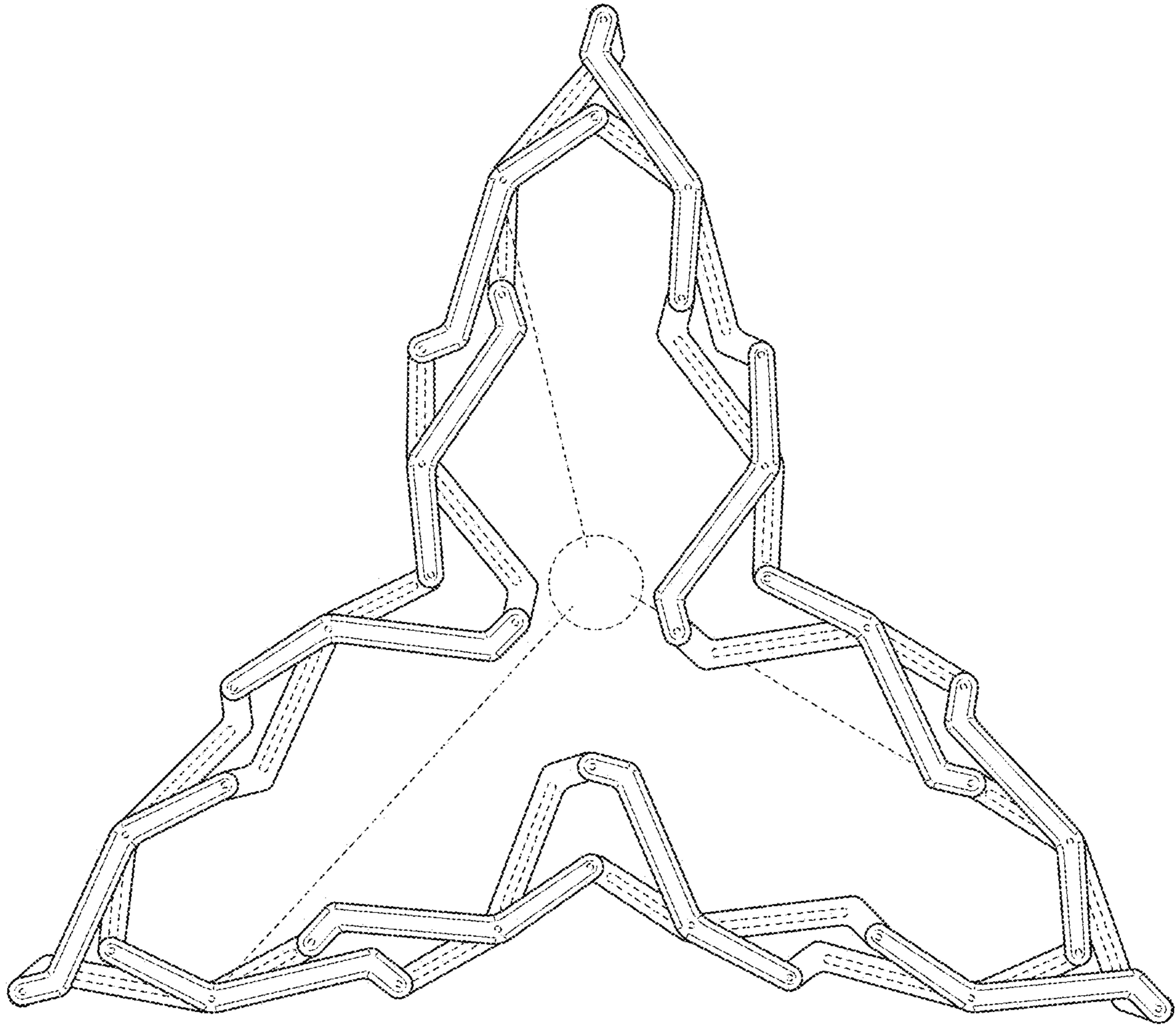

FIG. 27