



US00D894354S

(12) **United States Design Patent**  
**Guan et al.**

(10) **Patent No.:** **US D894,354 S**

(45) **Date of Patent:** **\*\* Aug. 25, 2020**

(54) **INTELLIGENT TOILET SEAT COVER**

(71) Applicant: **Zhejiang IKAHE Sanitary Ware Co., Ltd**, Taizhou (CN)

(72) Inventors: **Chenyi Guan**, Taizhou (CN); **Rui Liu**, Taizhou (CN); **Feng Lin**, Taizhou (CN); **Weijian Cai**, Taizhou (CN); **Jinguang Yuan**, Taizhou (CN)

(73) Assignee: **Zhejiang IKAHE Sanitary Ware Co., Ltd**, Taizhou (CN)

(\*\*) Term: **15 Years**

(21) Appl. No.: **29/714,589**

(22) Filed: **Nov. 25, 2019**

(30) **Foreign Application Priority Data**

May 28, 2019 (CN) ..... 2019 3 0267924

(51) **LOC (12) Cl.** ..... **23-02**

(52) **U.S. Cl.**  
USPC ..... **D23/311**

(58) **Field of Classification Search**  
USPC ..... D23/295, 300–301, 309, 311–312  
CPC ..... A47K 13/00; A47K 13/005; A47K 13/02;  
A47K 13/04; A47K 13/14; A47K 13/12  
See application file for complete search history.

(56) **References Cited**

**U.S. PATENT DOCUMENTS**

D367,922 S \* 3/1996 Kobayashi ..... D23/311  
D594,945 S \* 6/2009 Nakasaki ..... D23/311

D617,883 S \* 6/2010 Choi ..... D23/311  
D692,541 S \* 10/2013 Hosoi ..... D23/311  
D739,926 S \* 9/2015 Inomoto ..... D23/311  
D870,867 S \* 12/2019 Xing ..... D23/311

\* cited by examiner

*Primary Examiner* — Robert A Delehanty

(57) **CLAIM**

The ornamental design for an intelligent toilet seat cover, as shown and described.

**DESCRIPTION**

FIG. 1 is a front view of an embodiment of an ornamental design for an intelligent toilet seat cover showing our new design;

FIG. 2 is a rear elevation view thereof;

FIG. 3 is a left side elevation view thereof;

FIG. 4 is a right side elevation view thereof;

FIG. 5 is a top plan view thereof;

FIG. 6 is a bottom plan view thereof;

FIG. 7 is a perspective view thereof; and,

FIG. 8 is another perspective view showing the intelligent toilet seat cover in a use state.

The broken lines depict portions of the intelligent toilet seat cover in which the design is embodied that form no part of the claimed design.

The shade lines in the figures show contour and not surface ornamentation.

**1 Claim, 8 Drawing Sheets**

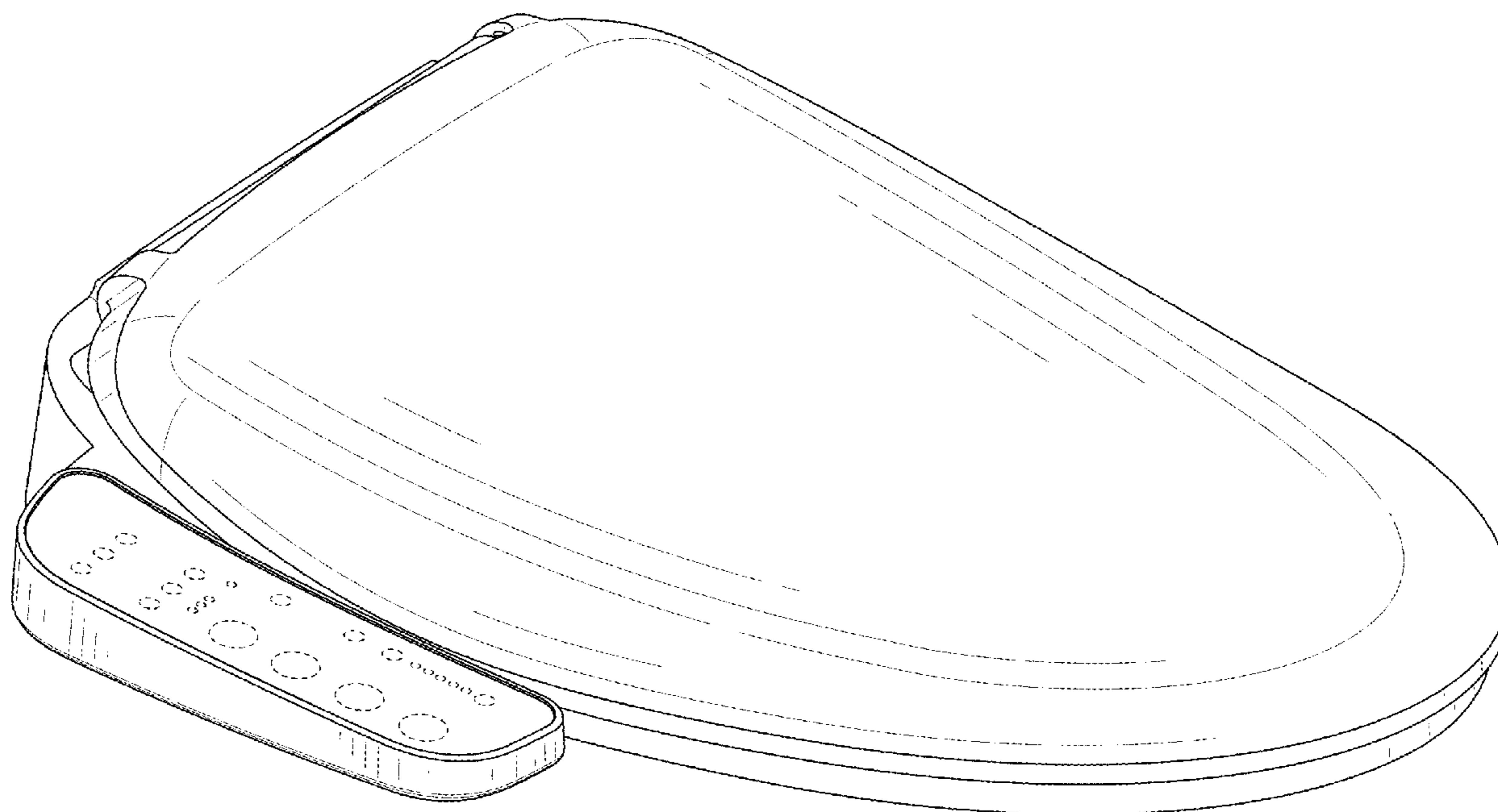

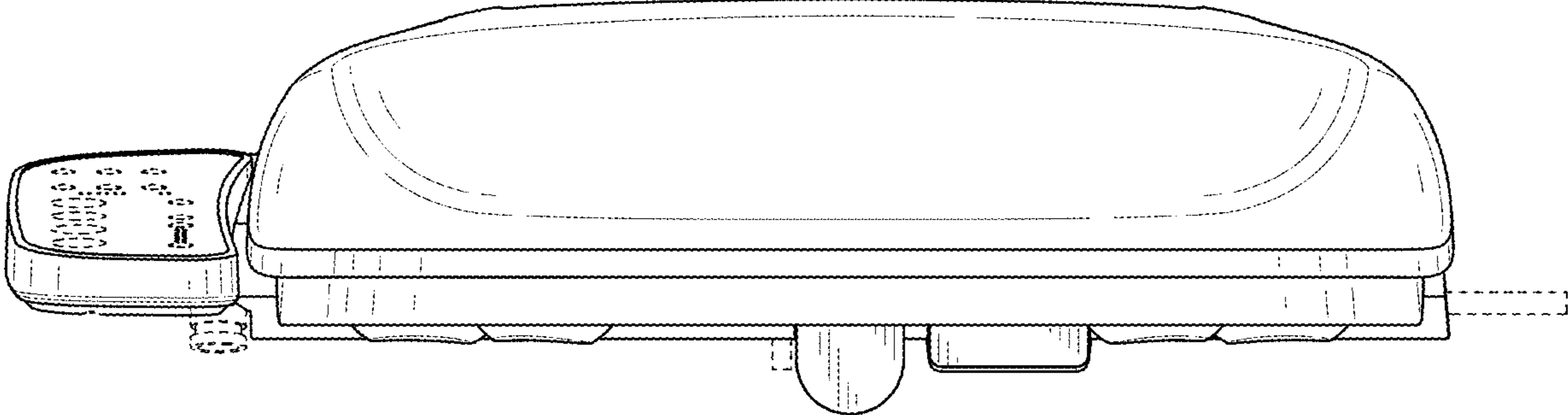

FIG. 1

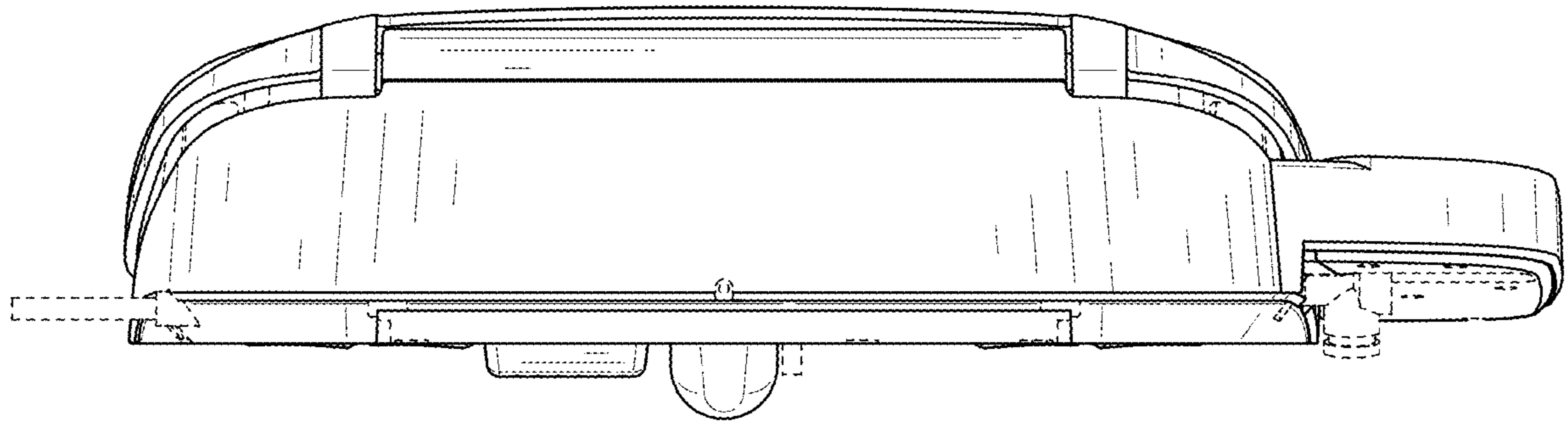

FIG. 2

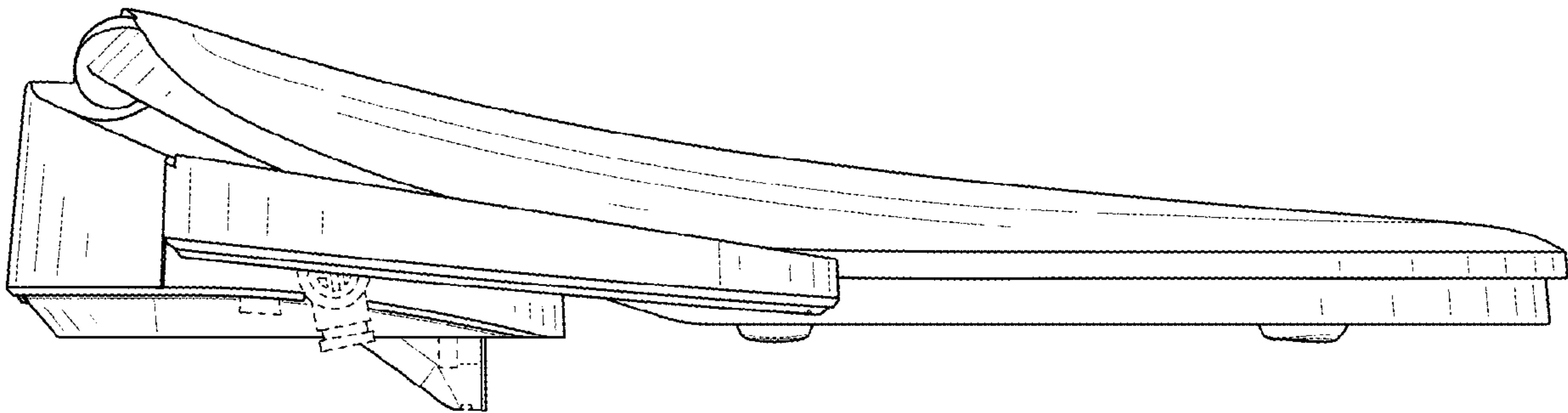

FIG. 3

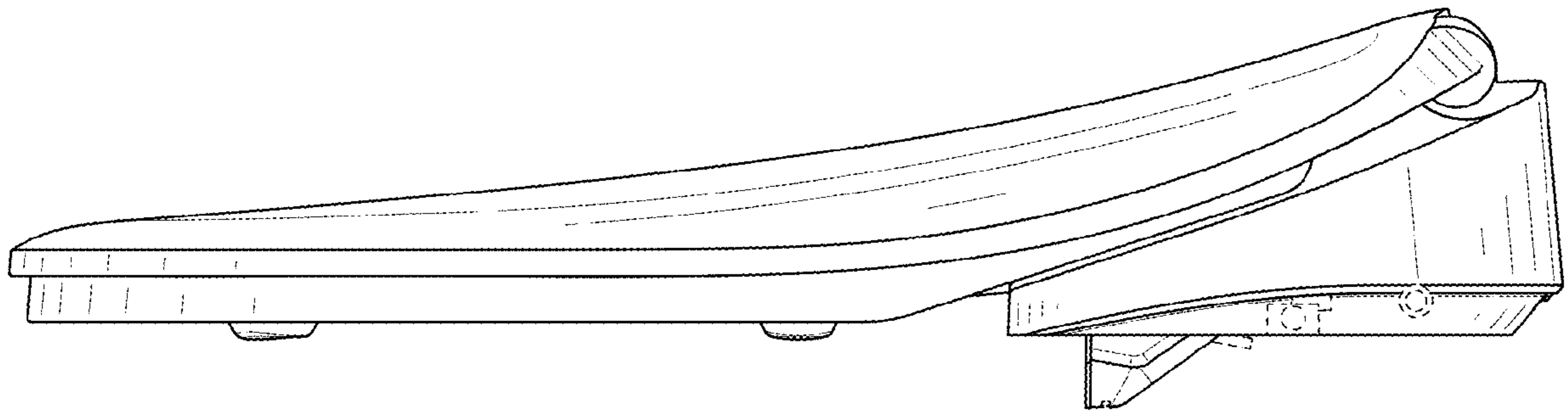

FIG. 4

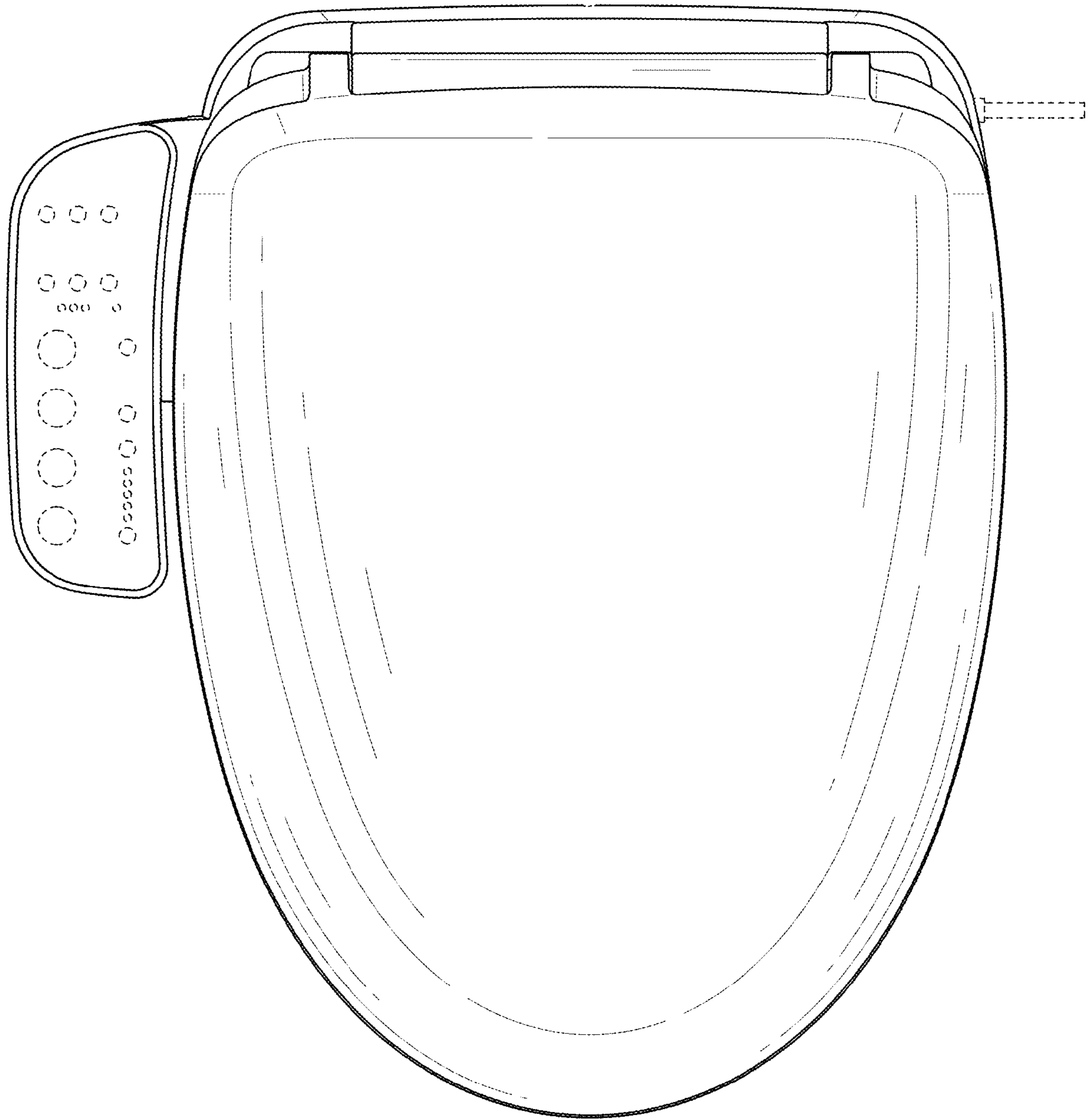

FIG. 5

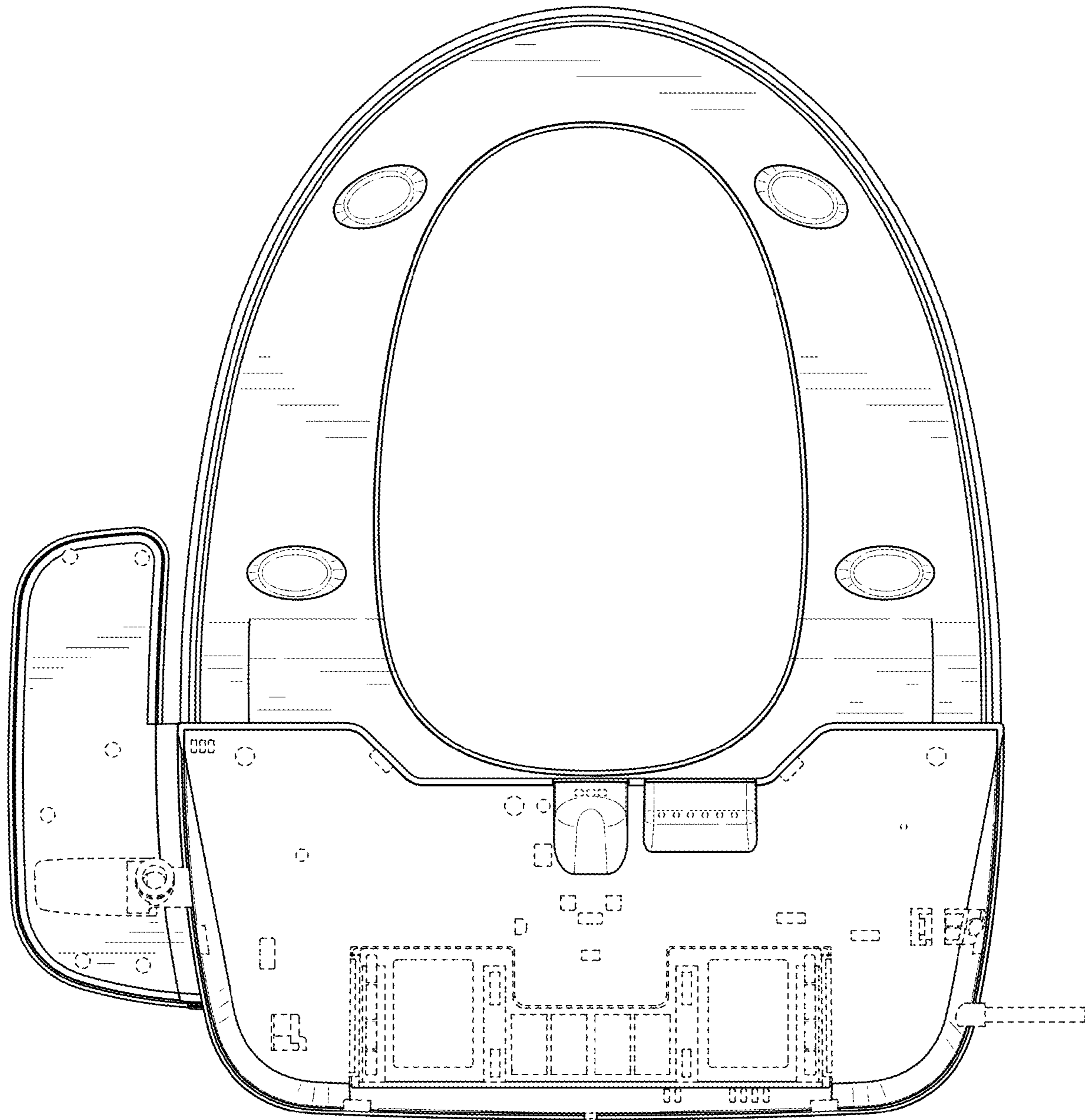

FIG. 6

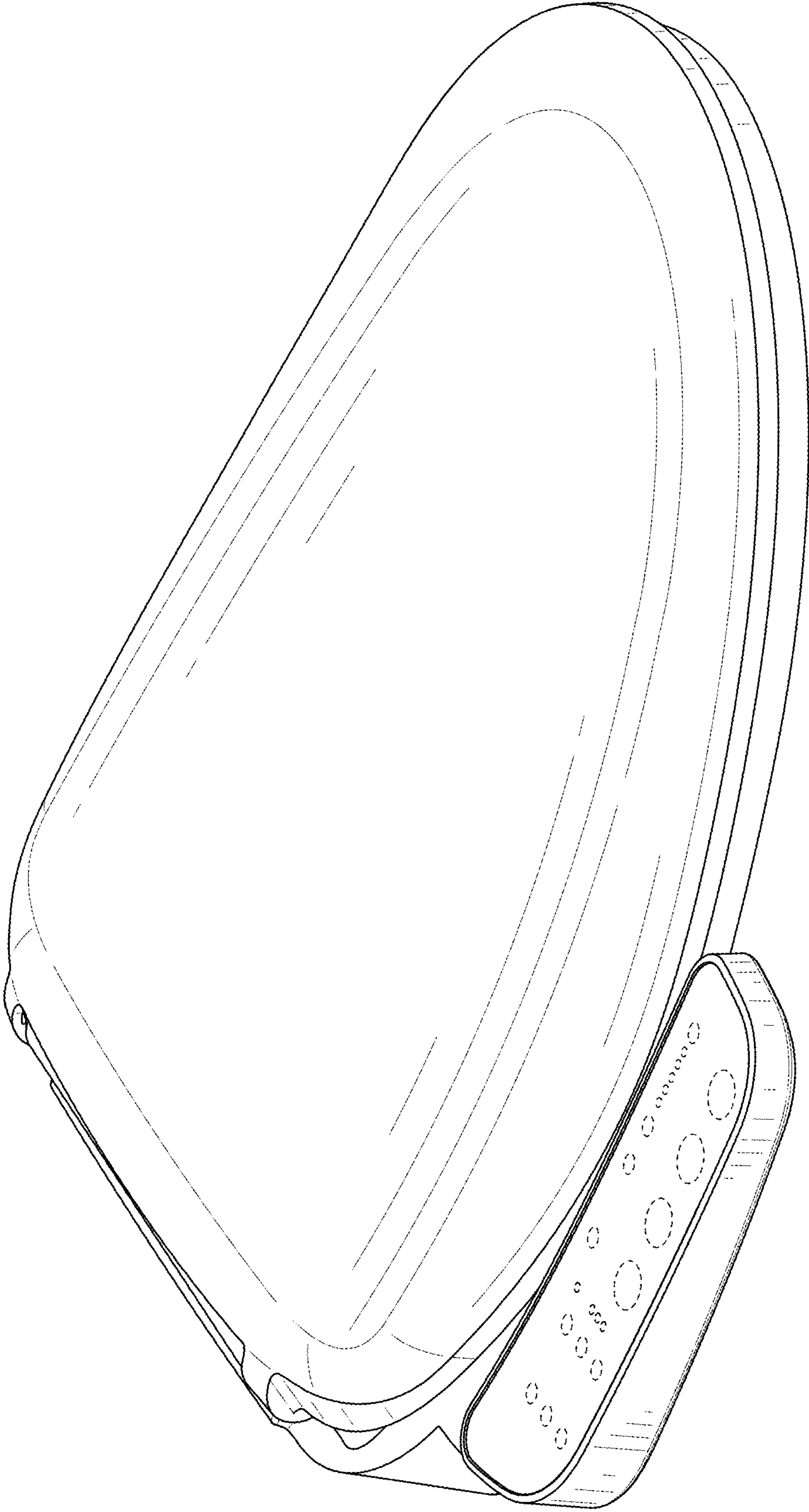

FIG. 7



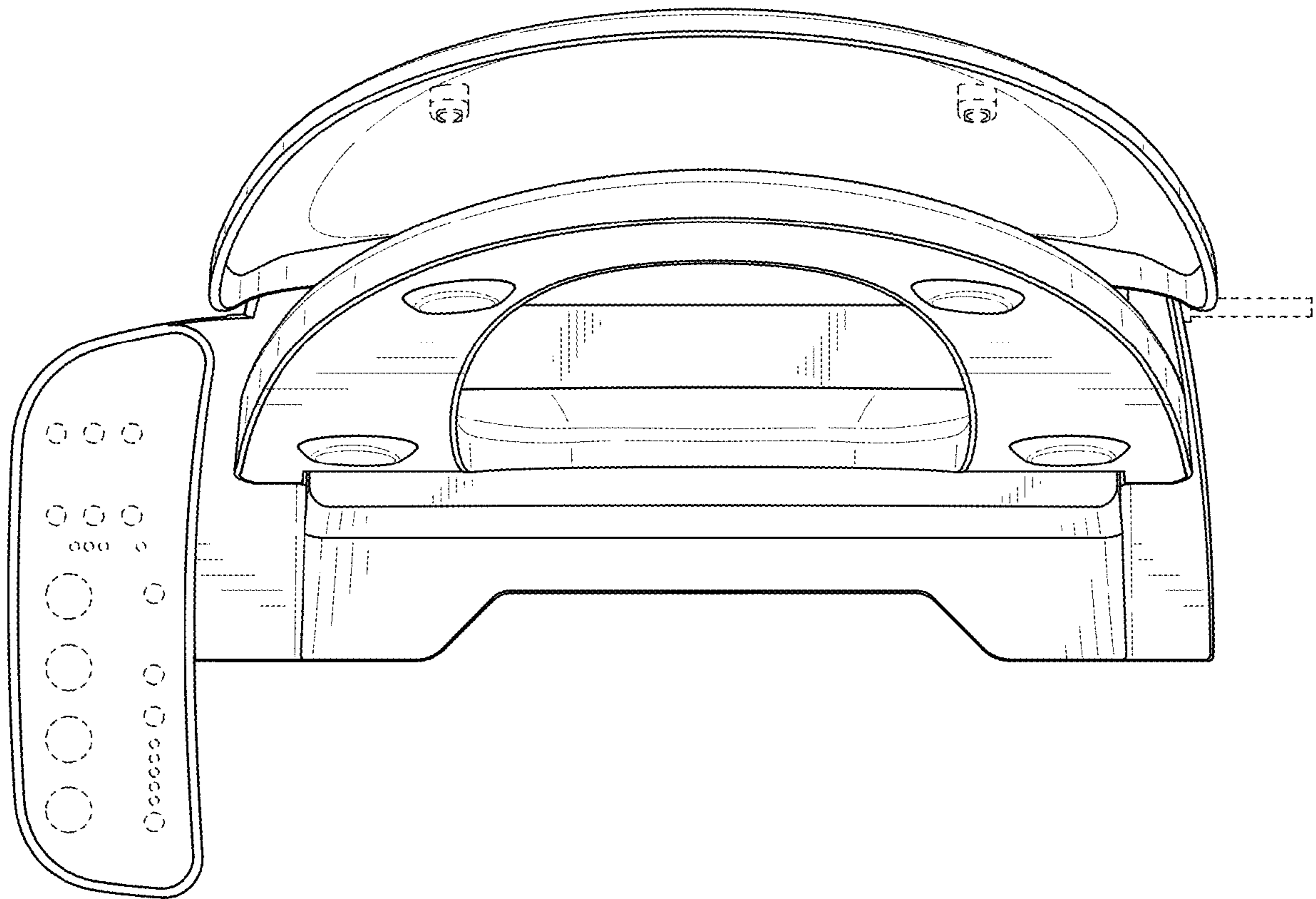

FIG. 8