

US00D894171S

(12) **United States Design Patent**  
**Quilling, II**

(10) **Patent No.:** **US D894,171 S**

(45) **Date of Patent:** **\*\* Aug. 25, 2020**

(54) **AUTO STEREO MOUNTING DEVICE**

(71) Applicant: **Metra Electronics Corporation**, Holly Hill, FL (US)

(72) Inventor: **R. Spencer Quilling, II**, Holly Hill, FL (US)

(73) Assignee: **Metra Electronics Corporation**, Holly Hill, FL (US)

(\*\*) Term: **15 Years**

(21) Appl. No.: **29/684,095**

(22) Filed: **Mar. 19, 2019**

(51) **LOC (12) Cl.** ..... **14-03**

(52) **U.S. Cl.**  
USPC ..... **D14/258**

(58) **Field of Classification Search**  
USPC ..... D12/192, 195, 415, 420; D14/496,  
D14/498-506, 154, 157, 168-171,  
D14/188-198, 257-258; 248/27.1, 27.3,  
248/558  
CPC ..... B60R 11/02; B60K 37/04; B60K 37/06;  
B60K 35/00  
See application file for complete search history.

(56) **References Cited**

**U.S. PATENT DOCUMENTS**

D481,378 S \* 10/2003 Quilling, II ..... D14/258  
D483,027 S \* 12/2003 Quilling, II ..... D14/258

D555,645 S \* 11/2007 Quilling, II ..... D14/258  
D610,580 S \* 2/2010 Fiore, IV ..... D14/258  
D639,288 S \* 6/2011 Fiore, IV ..... D14/258  
D639,797 S \* 6/2011 Fiore, IV ..... D14/258  
D702,674 S \* 4/2014 Fiore, IV ..... D14/258  
D704,697 S \* 5/2014 Fiore, IV ..... D14/258  
D852,189 S \* 6/2019 Carr ..... D14/258

\* cited by examiner

*Primary Examiner* — Sandra L Morris

(74) *Attorney, Agent, or Firm* — J. Wiley Horton

(57) **CLAIM**

The ornamental design for an “auto stereo mounting device,” as shown and described.

**DESCRIPTION**

FIG. 1 is a perspective view of an auto stereo mounting device, showing my design;  
FIG. 2 is a front elevation view of FIG. 1;  
FIG. 3 is a rear elevation view of FIG. 1;  
FIG. 4 is a left side elevation view of FIG. 1;  
FIG. 5 is a right side elevation view of FIG. 1;  
FIG. 6 is a top plan view of FIG. 1; and,  
FIG. 7 is a bottom plan view of FIG. 1.  
The broken lines shown in all views illustrate mounting features which form no part of the claimed design.

**1 Claim, 7 Drawing Sheets**

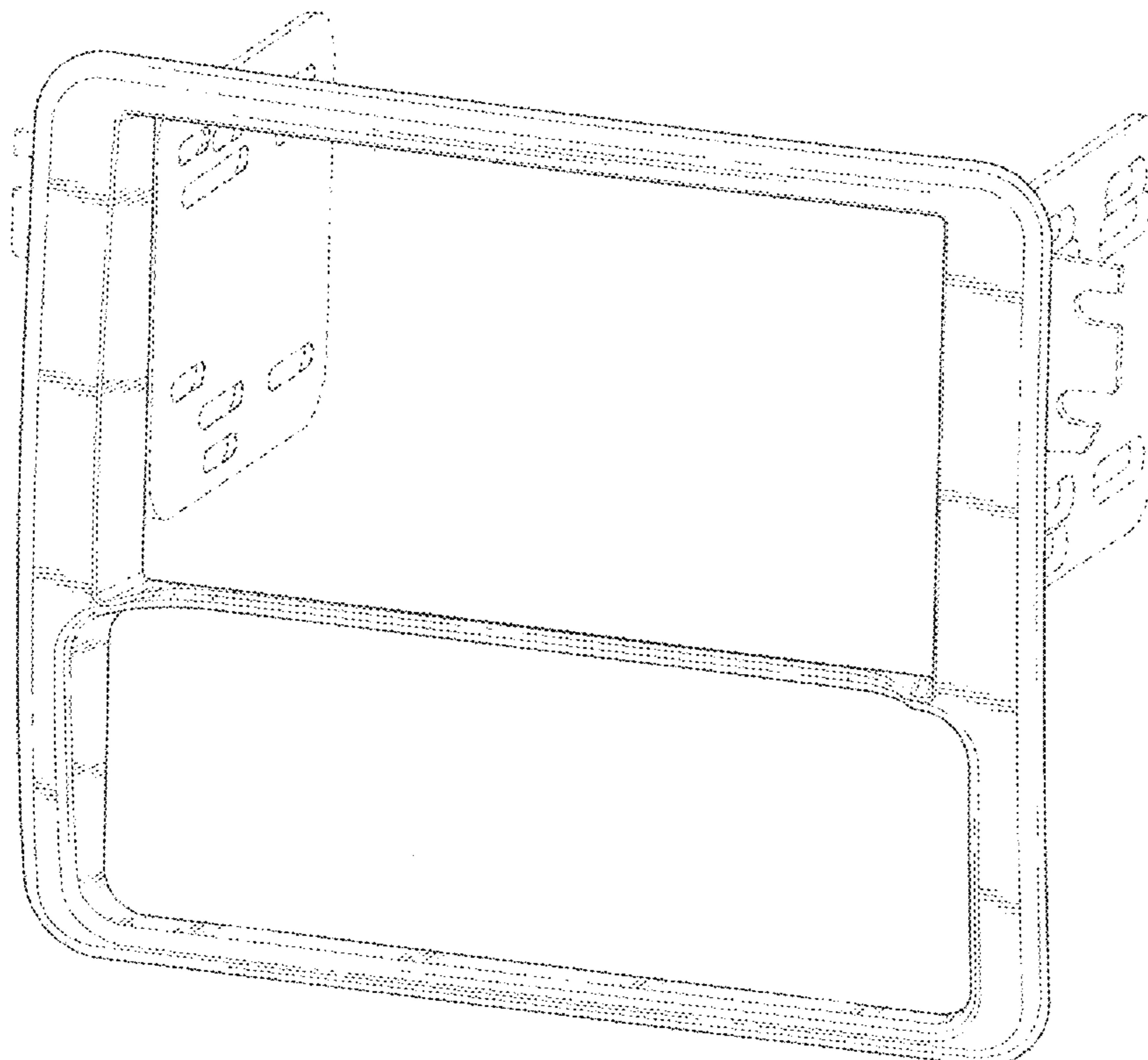

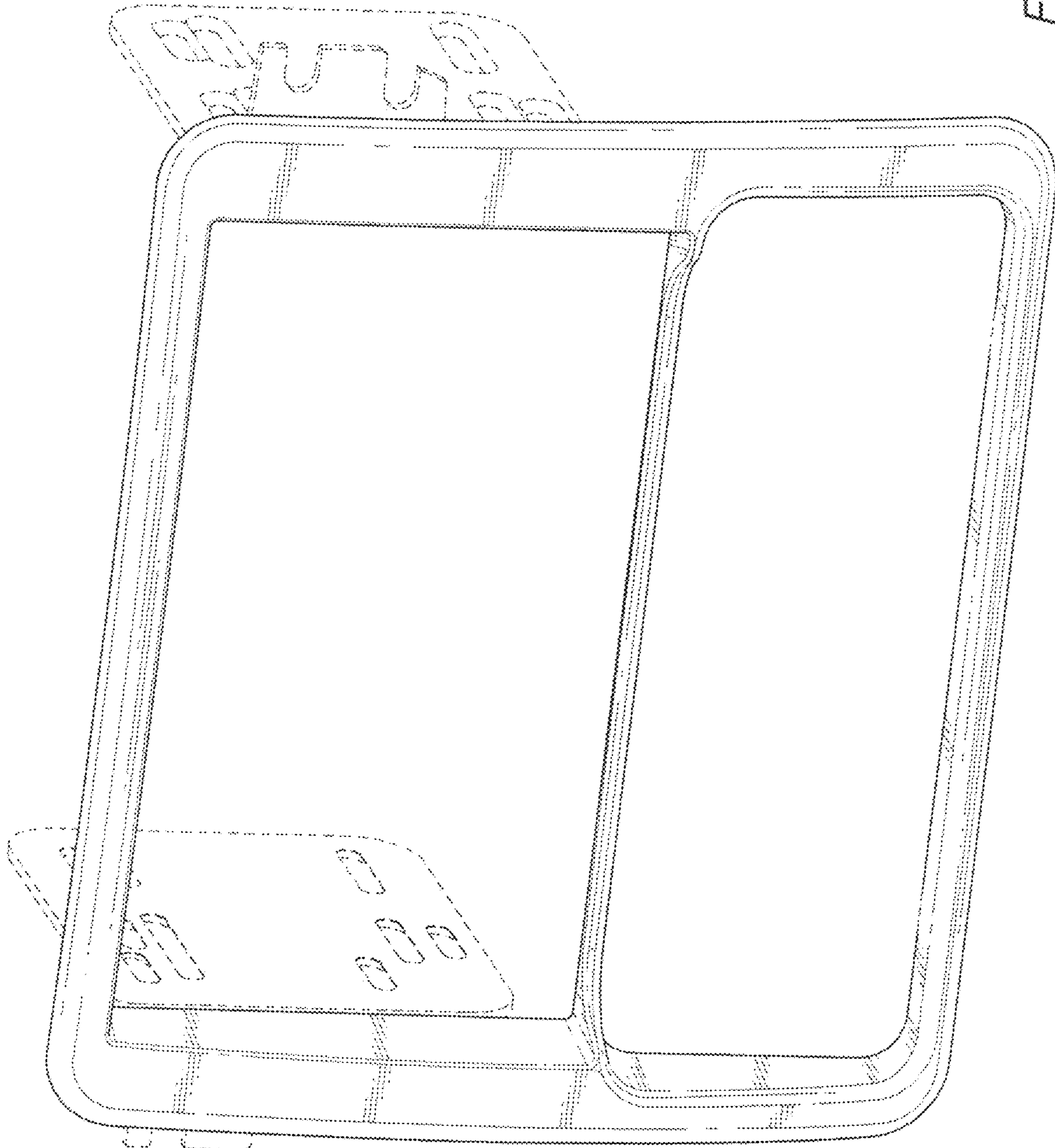

FIG. 1

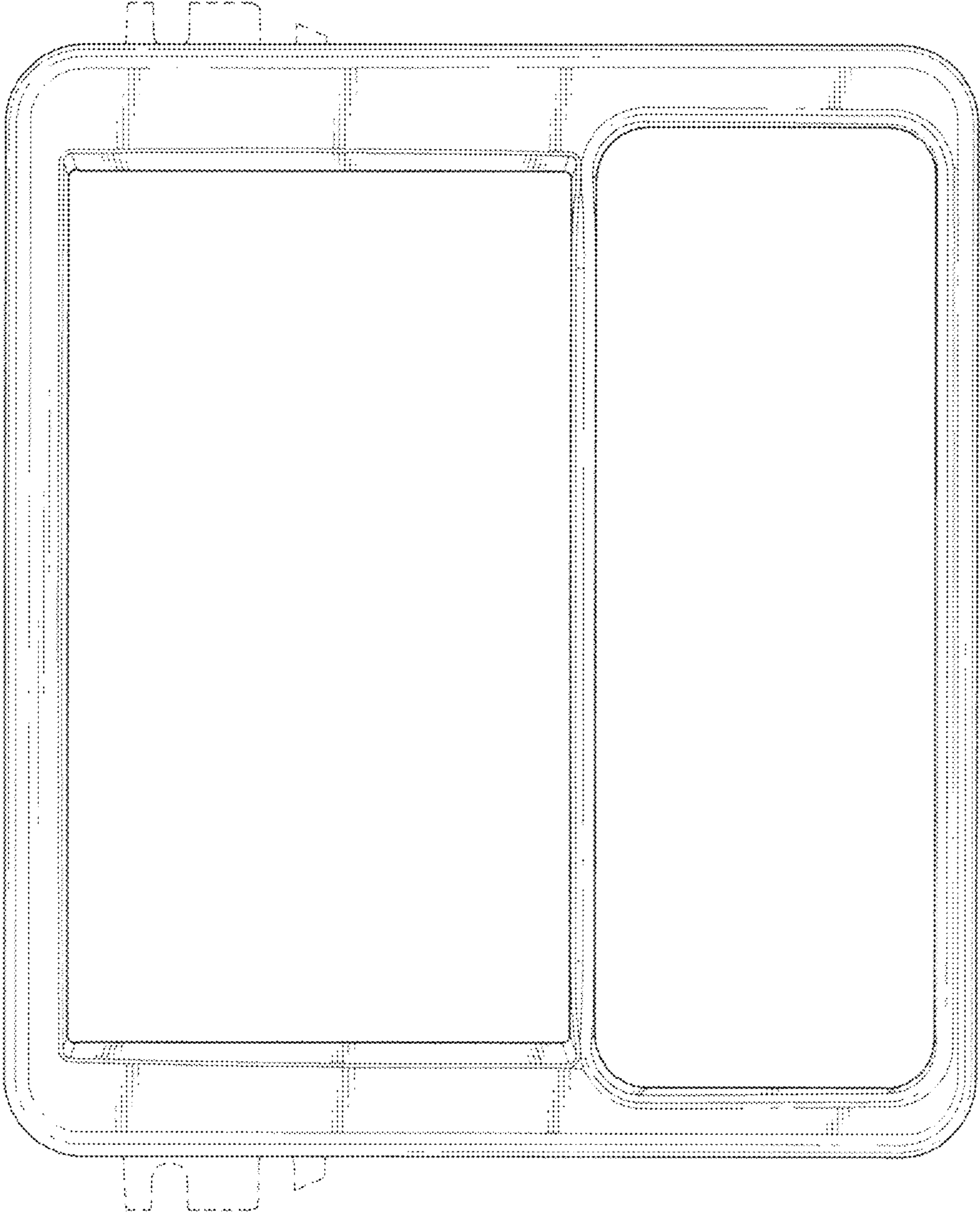

FIG. 2

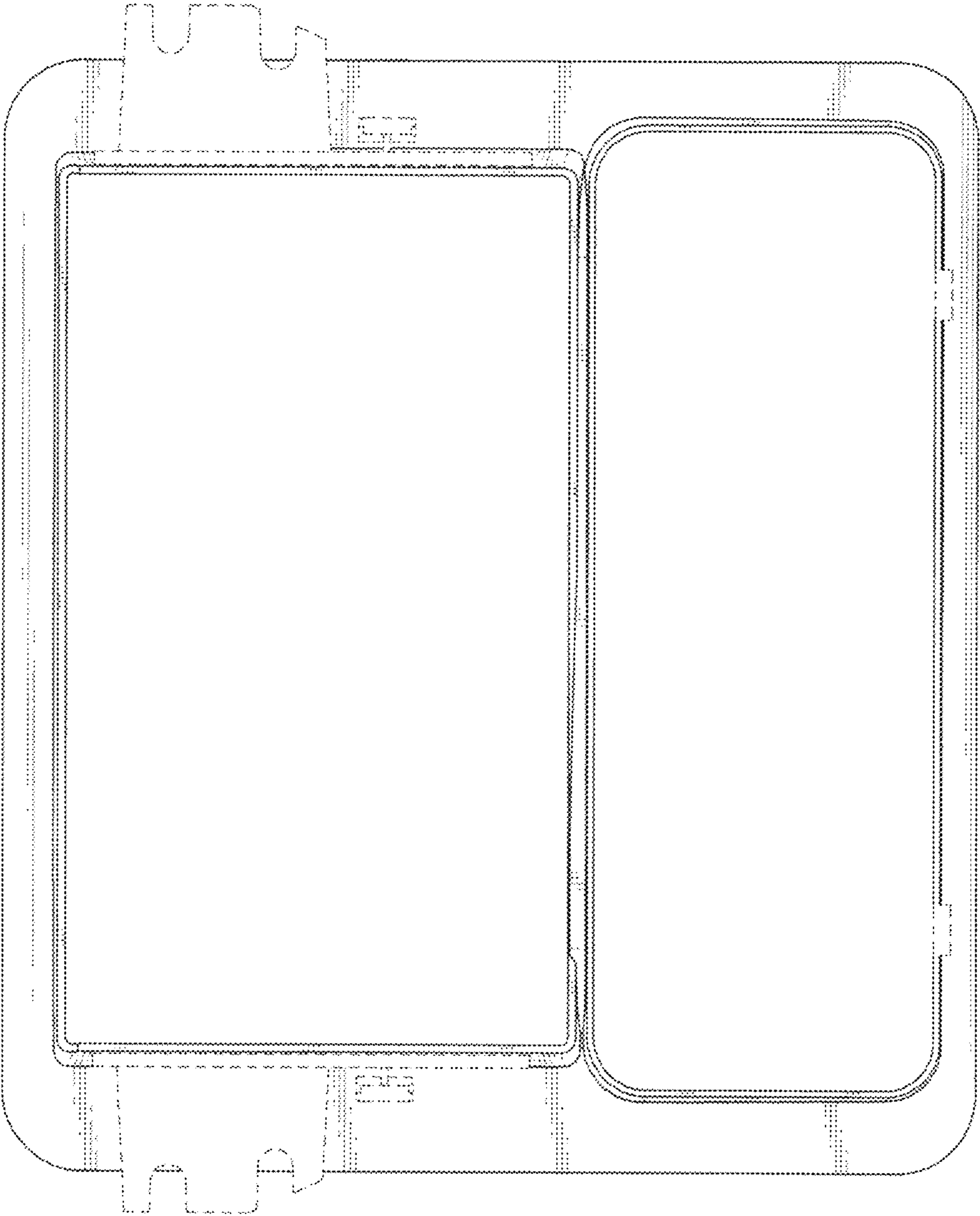

FIG. 3

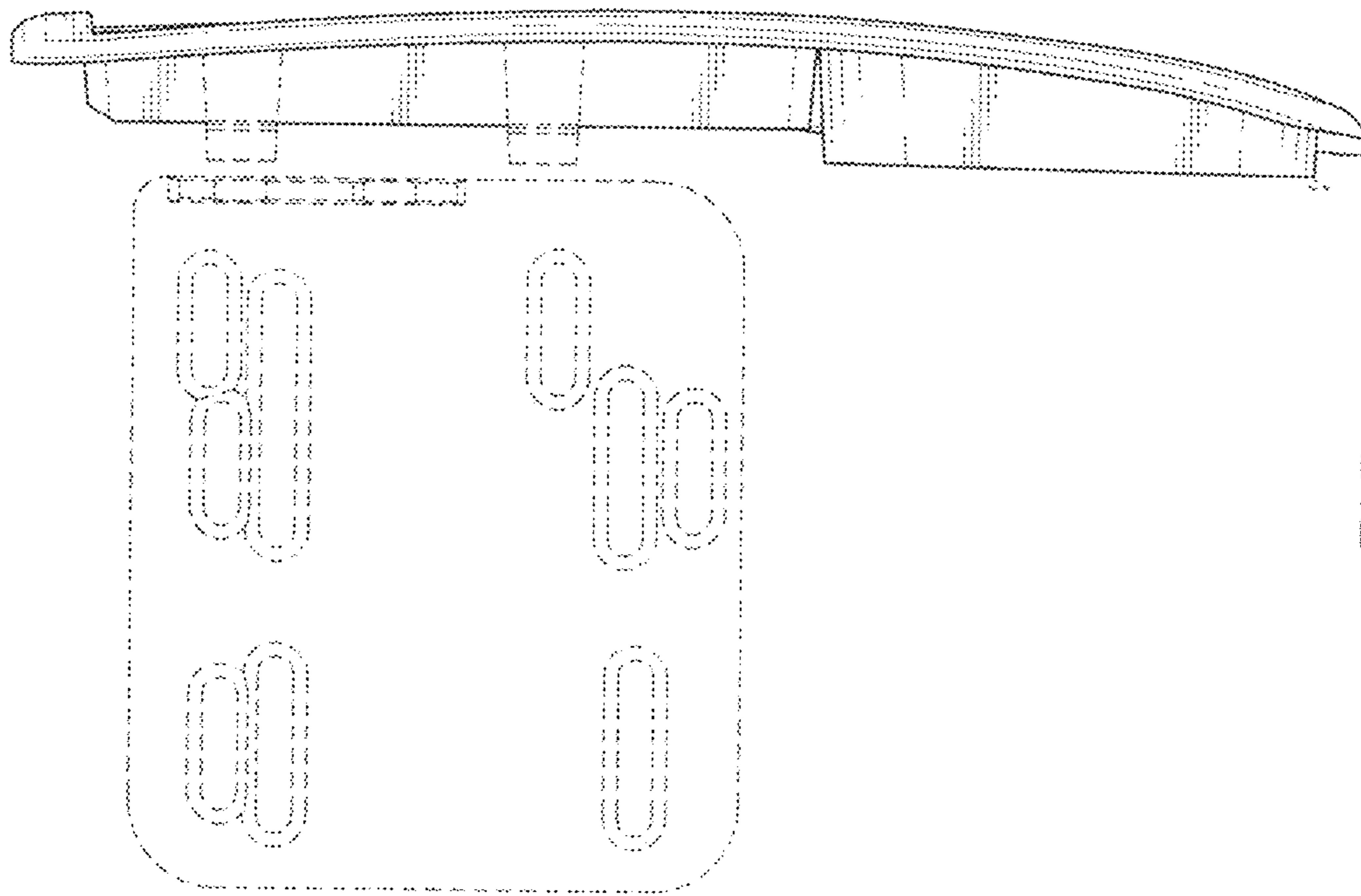

FIG. 4

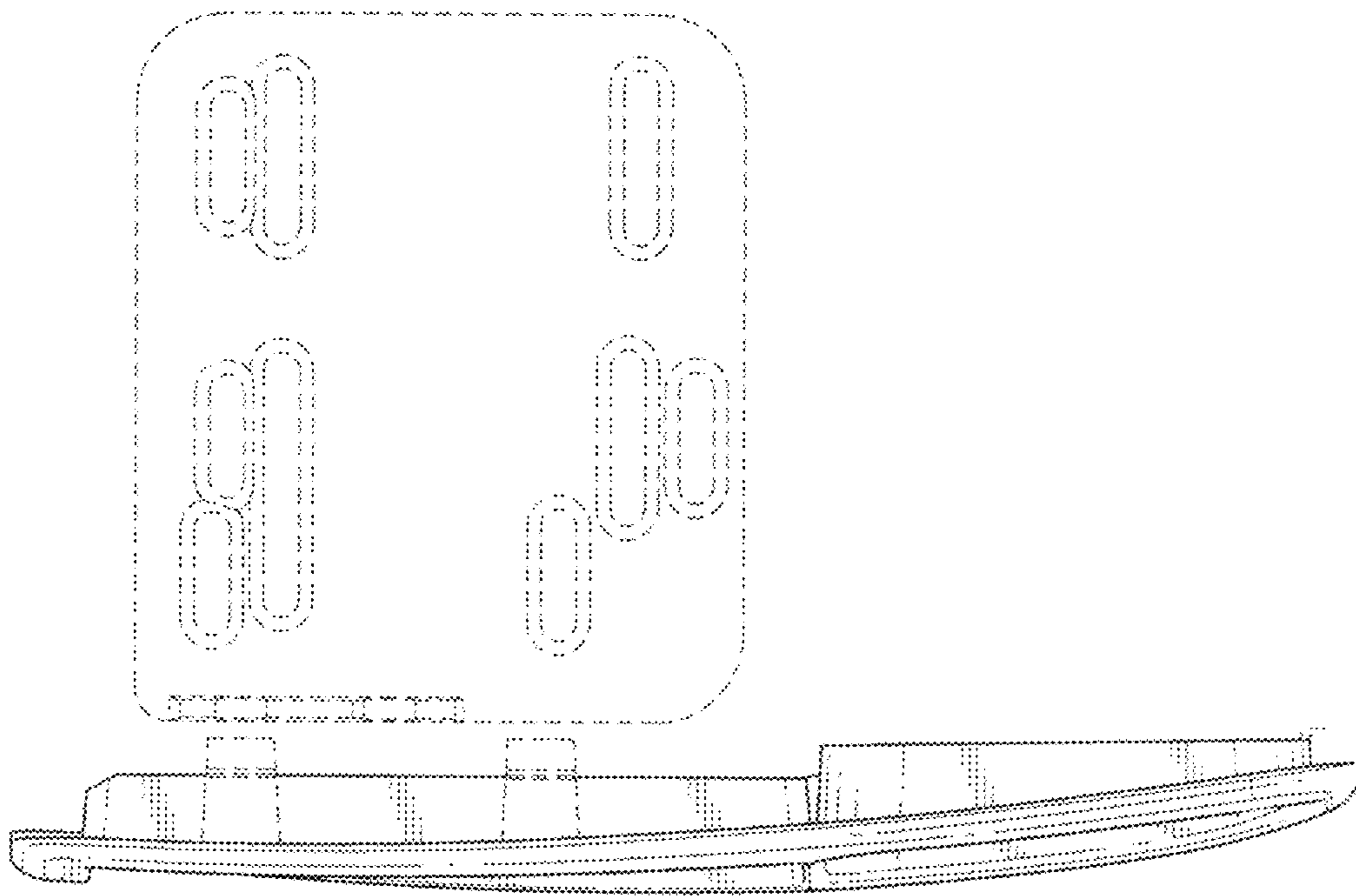

FIG. 5

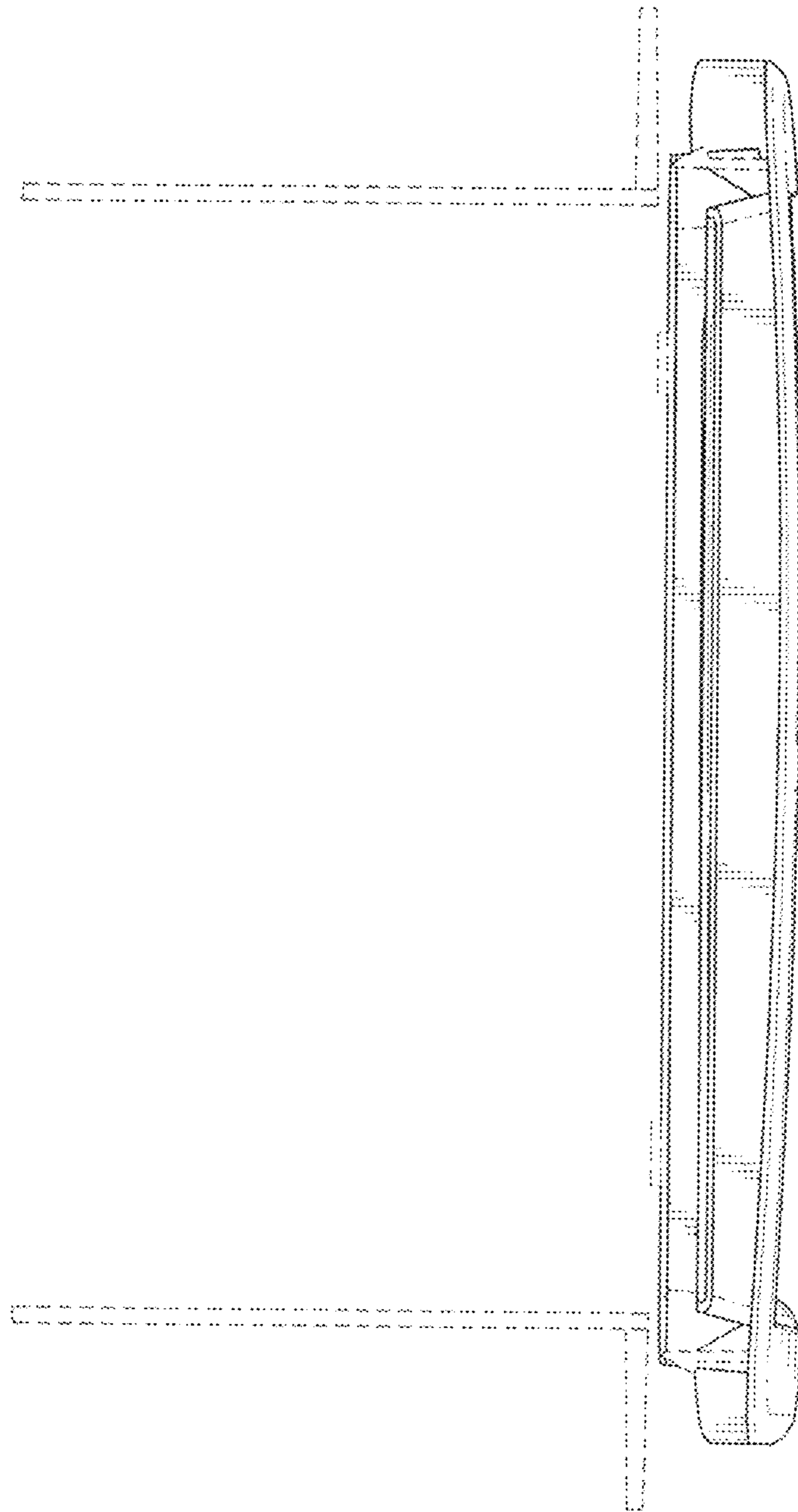

FIG. 6

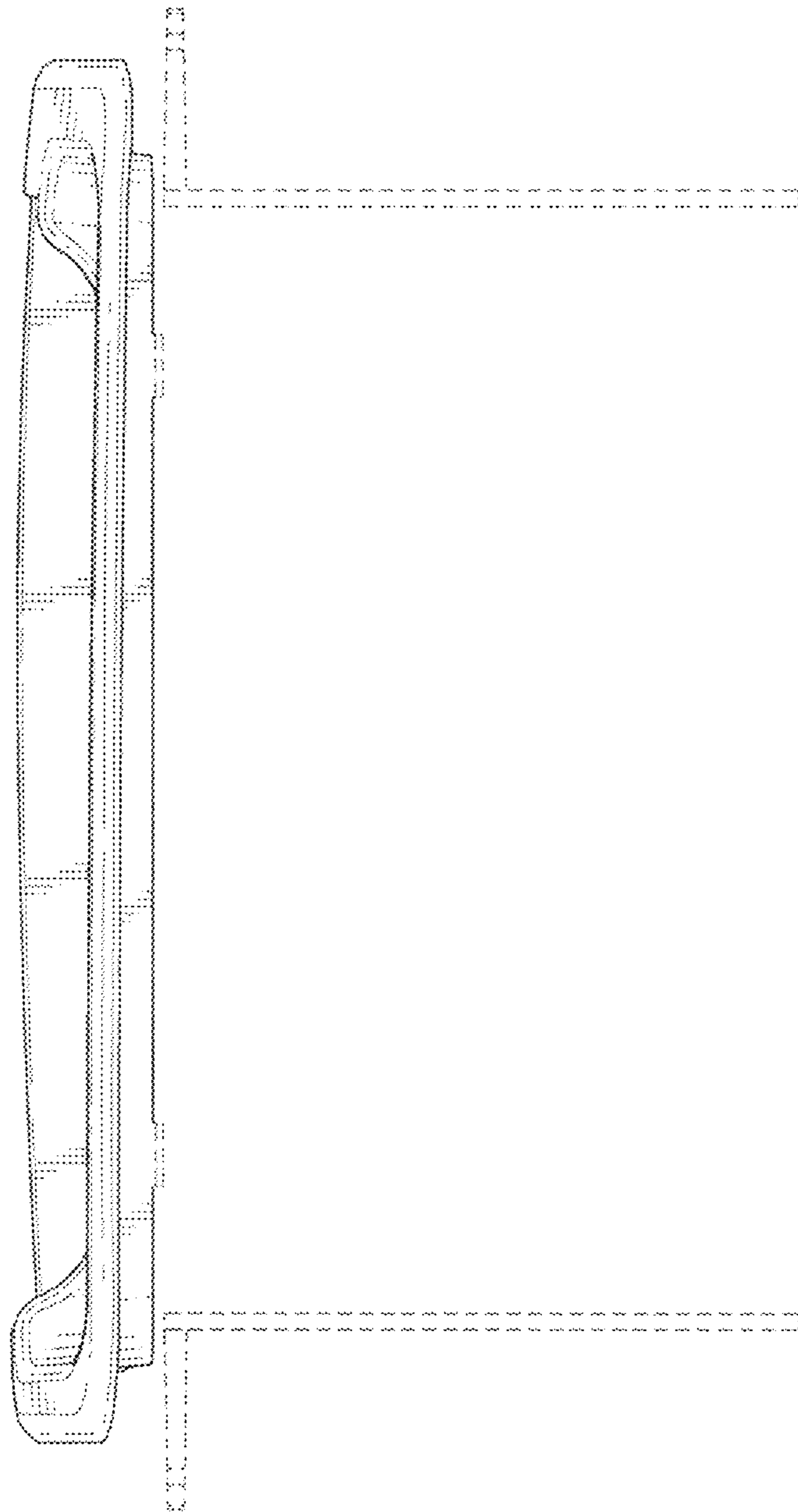

FIG. 7