



US00D894164S

(12) **United States Design Patent** (10) **Patent No.:** **US D894,164 S**
Kim (45) **Date of Patent:** **** Aug. 25, 2020**

(54) **CASE FOR ELECTRONIC COMMUNICATIONS DEVICE**

(71) Applicant: **SPIGEN KOREA CO., LTD.**, Seoul (KR)

(72) Inventor: **Ji Hyun Kim**, Seoul (KR)

(73) Assignee: **Spigen Korea CO., LTD.**, Seoul (KR)

(**) Term: **15 Years**

(21) Appl. No.: **29/671,310**

(22) Filed: **Nov. 26, 2018**

(51) **LOC (12) Cl.** **14-03**

(52) **U.S. Cl.**
USPC **D14/250**

(58) **Field of Classification Search**
USPC D14/439, 203.3–203.7, 447, 238.1,
D14/251–253, 217, 240, 250, 440, 248;
(Continued)

(56) **References Cited**

U.S. PATENT DOCUMENTS

D613,761 S 4/2010 Jones
D613,762 S 4/2010 Jones
(Continued)

OTHER PUBLICATIONS

“Spigen Tough Armor iPhone SE/5S/5 Case with Extreme Heavy Duty Protection and Air Cushion Technology for iPhone SE/iPhone 5S/iPhone 5—Metal Slate”, <https://www.amazon.com/Spigen-Extreme-Protection-Cushion-Technology/dp/B00DMKGPP4>, Earliest review date of Aug. 1, 2013, Downloaded on Aug. 9, 2018.
(Continued)

Primary Examiner — Carla J Wright

(74) *Attorney, Agent, or Firm* — Heedong Chae; Lucem, PC

(57) **CLAIM**

The ornamental design for a case for electronic communications device, as shown and described.

DESCRIPTION

FIG. 1 is a front perspective view of a case for electronic communications device showing my new design; FIG. 2 is a rear perspective view thereof; FIG. 3 is a front elevational view thereof; FIG. 4 is a rear elevational view thereof; FIG. 5 is a left side elevational view thereof; FIG. 6 is a right side elevational view thereof; FIG. 7 is a top plan view thereof; FIG. 8 is a bottom plan view thereof; FIG. 9 is a front perspective view showing the inner shell component of the case in isolation; FIG. 10 is a rear perspective view showing the inner shell component of the case in isolation; FIG. 11 is a front perspective view showing the outer frame component of the case in isolation; FIG. 12 is a rear perspective view showing the outer frame component of the case in isolation; FIG. 13 is an exploded front perspective view showing the components of the case separated for clarity of disclosure; and, FIG. 14 is an exploded rear perspective view showing the components of the case separated for clarity of disclosure. For clarity of disclosure, the components of the case are shown in isolation in FIGS. 9-12 and separated in FIGS. 13-14. Although the case for electronic communications device, in which the claimed design is embodied, consists of an inner shell component, an outer frame component, and an environmental kickstand component, the claim is directed to the ornamental appearance of the case in its entirety and does not extend to the ornamental appearance of each of the individual components. The broken lines throughout the drawing figures depict portions of the case for electronic communications device that form no part of the claimed design. The broken lines and regions bounded by broken lines form no part of the claimed design.

1 Claim, 14 Drawing Sheets

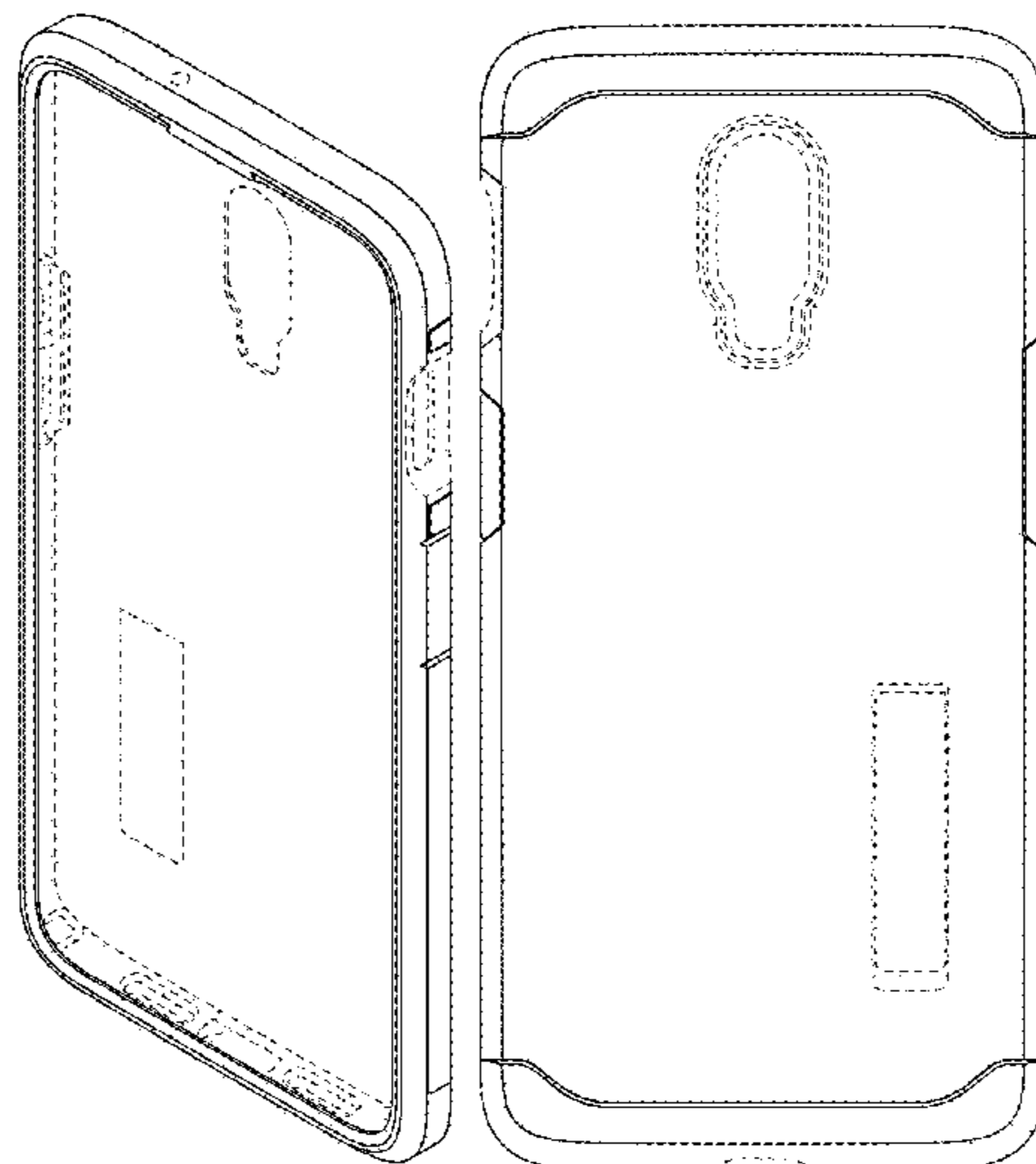

(56)

References Cited

OTHER PUBLICATIONS

Mint”, <https://www.amazon.com/Spigen-Extreme-Protection-Kickstand-Feature/dp/B00LL65B06>, Earliest review date of Sep. 18, 2014, Downloaded on Jan. 15, 2019.

“Spigen Tough Armor Galaxy Note 4 Case with Extreme Heavy Duty Protection and Air Cushion Technology for Samsung Galaxy Note 4 2014—Gunmetal”, <https://www.amazon.com/dp/B00MAWOU14>, Earliest review date of Oct. 9, 2014, Downloaded on Aug. 31, 2018.

“Spigen Tough Armor FX iPhone 6 Case with Extreme Protection and Front Built-In Screen Protector Cover for iPhone 6S/iPhone 6—Gunmetal”, <https://www.amazon.com/Spigen-iPhone-Extreme-Protection-Protector/dp/B00PR9XE5C>, Earliest review date of Jan. 8, 2015, Downloaded on Jan. 15, 2019.

“Spigen Tough Armor Galaxy S6 Edge Case with Kickstand and Extreme Heavy Duty Protection and Air Cushion Technology for Galaxy S6 Edge 2015—Gunmetal”, <https://www.amazon.com/dp/B00SV63L38>, Earliest review date of Mar. 12, 2015, Downloaded on Aug. 9, 2018.

“Spigen Tough Armor Galaxy S6 Case with Kickstand and Air Cushion Technology for Galaxy S6 2015—Gunmetal”, <https://www.amazon.com/dp/B00QU4PUKK>, Earliest review date of Mar. 23, 2015, Downloaded on Aug. 9, 2018.

“Spigen Tough Armor iPhone 6S Case with Extreme Heavy Duty Protection and Air Cushion Technology for iPhone 6S/iPhone 6—Rose Gold”, <https://www.amazon.com/dp/B013TKNNGK>, Earliest review date of Aug. 30, 2015, Downloaded on Aug. 8, 2018.

“Spigen Tough Armor iPhone 6S Plus Case with Kickstand and Heavy Duty Air Cushion Technology Protection for iPhone 6S Plus/iPhone 6 Plus Only—Gunmetal”, <https://www.amazon.com/Spigen-Kickstand-Cushion-Technology-Protection/dp/B010MVQJPQ>, Earliest review date of Sep. 9, 2015, Downloaded on Aug. 9, 2018.

“Spigen Tough Armor Galaxy S7 Edge Case with Kickstand and Extreme Heavy Duty Protection and Air Cushion Technology for Samsung Galaxy S7 Edge 2016—Gunmetal”, <https://www.amazon.com/dp/B01A7IDNWQ>, Earliest review date of Feb. 24, 2016, Downloaded on Aug. 9, 2018.

“Spigen Tough Armor Galaxy S7 Case with Extreme Heavy Duty Protection and Air Cushion Technology for Samsung Galaxy S7 2016—Gunmetal”, <https://www.amazon.com/dp/B01A7ID3PS>, Earliest review date of Feb. 25, 2016, Downloaded on Aug. 9, 2018.

“Spigen Tough Armor LG G5 Case with Reinforced Kickstand and Heavy Duty Protection and Air Cushion Technology for LG G5 (2016)—Gunmetal”, <https://www.amazon.com/dp/B01B1GQL61>, Earliest review date of Mar. 11, 2016, Downloaded on Aug. 9, 2018.

“Spigen Tough Armor iPhone SE Case with Extreme Heavy Duty Protection and Air Cushion Technology for iPhone SE 2016—Black”, <https://www.amazon.com/Spigen-Extreme-Protection-Cushion-Technology/dp/B01BEJB9XM>, Earliest review date of Apr. 7, 2016, Downloaded on Aug. 9, 2018.

“Spigen Tough Armor Heavy Duty Extreme Protection Rugged Slim Dual Layer Protective Cover Case for Apple iPhone 7—Gunmetal”, <https://www.amazon.co.uk/dp/B01GIVWY30>, Date first available at Amazon.co.uk of Aug. 2, 2016, Downloaded on Sep. 17, 2018.

“Spigen Tough Armor iPhone 7 Plus/iPhone 8 Plus Case with Extreme Heavy Duty Protection and Air Cushion Technology with Kickstand for Apple iPhone 7 Plus 2016/iPhone 8 Plus 2017—Rose Gold”, <https://www.amazon.com/dp/B01GIWGE8A>, Earliest review date of Sep. 6, 2016, Downloaded on Aug. 9, 2018.

“Spigen Tough Armor iPhone 7 Case with Extreme Heavy Duty Protection and Air Cushion Technology for iPhone 7 2016—Black”, <https://www.amazon.com/dp/B01GIVX301>, Earliest review date of Sep. 9, 2016, Downloaded on Aug. 9, 2018.

“Spigen Tough Armor iPhone 7 Case with Jet Black Optimized Color and Extreme Heavy Duty Protection and Air cushion Technology for iPhone 7 2016—Jet Black”, <https://www.amazon.com/Spigen-Optimized-Extreme-Protection-Technology/dp/B01LRSFLFM>, Earliest review date of Sep. 25, 2016, Downloaded on Aug. 9, 2018.

“Spigen Tough Armor Google Pixel Case with Kickstand and Heavy Duty Air Cushion Technology Protection for Google Pixel 2016—Black”, <https://www.amazon.com/Spigen-Kickstand-Cushion-Technology-Protection/dp/B01M12Z4PY>, Earliest review date of Oct. 20, 2016, Downloaded on Aug. 9, 2018.

“Spigen Tough Armor Google Pixel XL Case with Kickstand and Heavy Duty Air Cushion Technology Protection for Google Pixel XL 2016—Gunmetal”, <https://www.amazon.com/Spigen-Kickstand-Cushion-Technology-Protection/dp/B01LZGCH6E>, Earliest review date of Oct. 21, 2016, Downloaded on Aug. 9, 2018.

“Spigen Tough Armor LG V20 Case with Kickstand and Extreme Heavy Duty Protection and Air Cushion Technology for LG V20—Gunmetal”, <https://www.amazon.com/Spigen-Kickstand-Extreme-Protection-Technology/dp/B01M9F154B>, Earliest review date of Dec. 2, 2016, Downloaded on Aug. 9, 2018.

“Spigen Tough Armor LG G6 Case with Extreme Heavy Duty Protection and Air Cushion Technology for LG G6 (2017)—Black”, <https://www.amazon.com/dp/B01MR8C4RY>, Earliest review date of Mar. 26, 2017, Downloaded on Aug. 3, 2018.

“Spigen Tough Armor Galaxy S8 Plus Case with Reinforced Kickstand and Heavy Duty Protection and Air Cushion Technology for Samsung Galaxy S8 Plus (2017)—Black”, <https://www.amazon.com/dp/B06XP4FP8N>, Earliest review date of Apr. 8, 2017, Downloaded on Aug. 9, 2018.

“Spigen Tough Armor Galaxy S8 Case with Kickstand and Extreme Heavy Duty Protection and Air Cushion Technology for Samsung Galaxy S8 (2017)—Black”, <http://www.amazon.com/dp/B0716CZ3Z1>, Earliest review date of Apr. 9, 2017, downloaded on Aug. 9, 2018.

“Spigen Tough Armor [2nd Generation] iPhone 8 Plus Case/iPhone 7 Plus Case with Kickstand Air Cushion Technology for Apple iPhone 8 Plus (2017)/iPhone 7 Plus (2016)—Black”, <http://www.amazon.com/dp/B07482KRLP>, Earliest review date of Aug. 18, 2017, downloaded on Jan. 15, 2019.

“Spigen Tough Armor [2nd Generation] iPhone 8 Plus Case/iPhone 7 Plus Case with Kickstand Air Cushion Technology for Apple iPhone 8 Plus (2017)/iPhone 7 Plus (2016)—Rose Gold”, <http://www.amazon.com/dp/B074826HMD>, Earliest review date of Aug. 18, 2017, downloaded on Aug. 9, 2018.

“Spigen Tough Armor Galaxy Note 8 Case with Kickstand and Extreme Heavy Duty Protection and Air Cushion Technology for Galaxy Note 8 (2017)—Orchid Gray”, <http://www.amazon.com/dp/B073R7MND3>, Earliest review date of Aug. 26, 2017, downloaded on Aug. 9, 2018.

“Spigen Tough Armor [2nd Generation] iPhone 8 Case/iPhone 7 Case with Kickstand and Heavy Duty Protection and Air Cushion Technology for Apple iPhone 8 (2017)/iPhone 7 (2016)—Gunmetal”, <http://www.amazon.com/dp/B07482KVD3>, Earliest review date of Sep. 2, 2017, downloaded on Aug. 9, 2018.

“Spigen Tough Armor LG V30 Case with Kickstand and Heavy Duty Protection for LG V30 (2017)—Black”, <http://www.amazon.com/dp/B071WS1TYG>, Earliest review date of Sep. 8, 2017, downloaded on Aug. 9, 2018.

“Spigen Tough Armor Galaxy S8 Active Case with Kickstand and Extreme Heavy Duty Protection and Air Cushion Technology for Galaxy S8 Active (2017)—Gunmetal”, <http://www.amazon.com/dp/B0746PT25T>, Earliest review date of Sep. 15, 2017, downloaded on Aug. 9, 2018.

“Spigen Tough Armor Designed for Apple iPhone X Case (2018)/Designed for Apple iPhone X Case (2017)—Matte Black”, <http://www.amazon.com/dp/B074CMT7HV>, Earliest review date of Sep. 27, 2017, downloaded on Jan. 15, 2019.

“Spigen Tough Armor Designed for Apple iPad Pro 10.5 Case (2017)—Black”, <http://www.amazon.com/dp/B0751GFB8X>, Earliest review date of Oct. 11, 2017, downloaded on Jan. 15, 2019.

“Spigen Tough Armor Designed for Apple iPad 9.7 Case iPad Case (2017/2018)—Black”, <http://www.amazon.com/dp/B072F7DGMJ>, Earliest review date of Oct. 23, 2017, downloaded on Jan. 15, 2019.

“Spigen Tough Armor Google Pixel 2 Case with Kickstand and Extreme Heavy Duty Protection and Air Cushion Technology for Google Pixel 2 (2017)—Gunmetal”, <http://www.amazon.com/dp/B0747523HC>, Earliest review date of Oct. 28, 2017, downloaded on Aug. 9, 2018.

(56)

References Cited

OTHER PUBLICATIONS

“Spigen Tough Armor Google Pixel 2 XL Case with Kickstand and Extreme Heavy Duty Protection and Air Cushion Technology for Google Pixel 2 XL (2017)—Black”, <http://www.amazon.com/dp/B07477LL8Q>, Earliest review date of Oct. 29, 2017, downloaded on Aug. 9, 2018.

“Spigen Tough Armor Moto Z2 Force Case with Kickstand and Extreme Heavy Duty Protection and Air Cushion Technology for Moto Z2 Force (2017)—Gunmetal”, <http://www.amazon.com/dp/B074PB5HQ1>, Earliest review date of Nov. 21, 2017, downloaded on Aug. 9, 2018.

* cited by examiner

FIG. 1

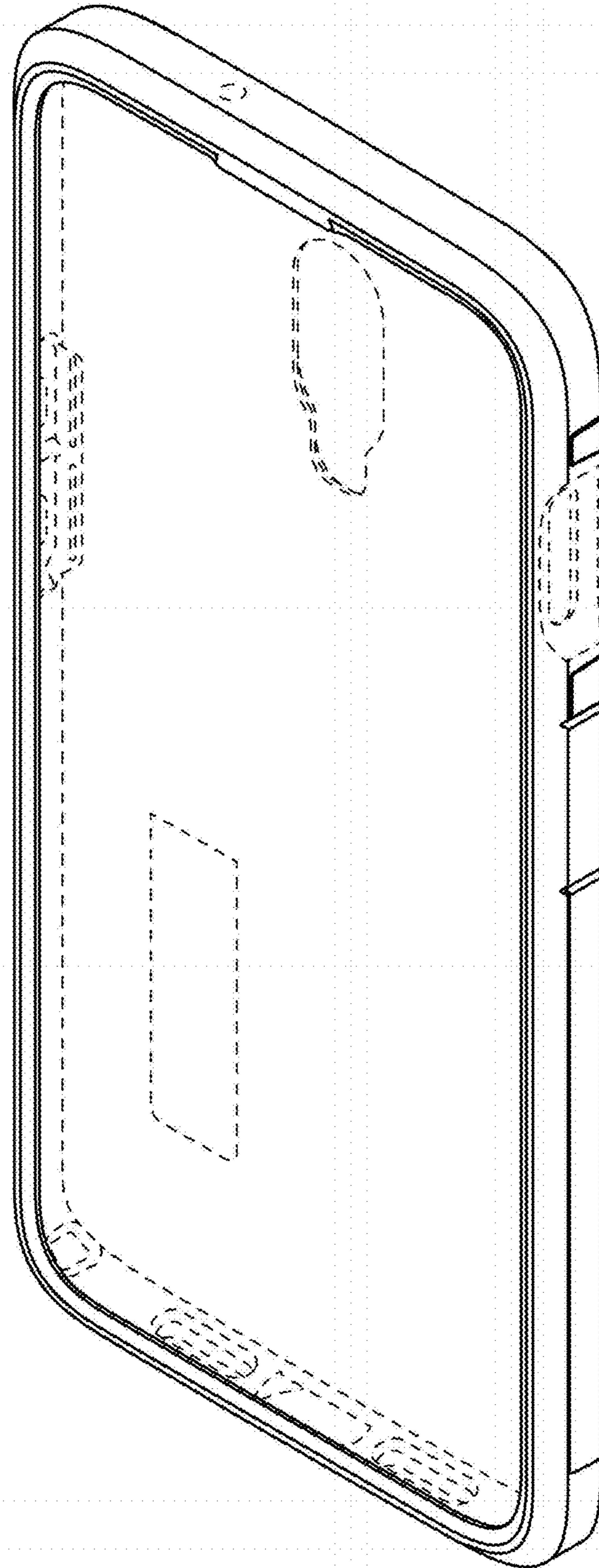

FIG. 2

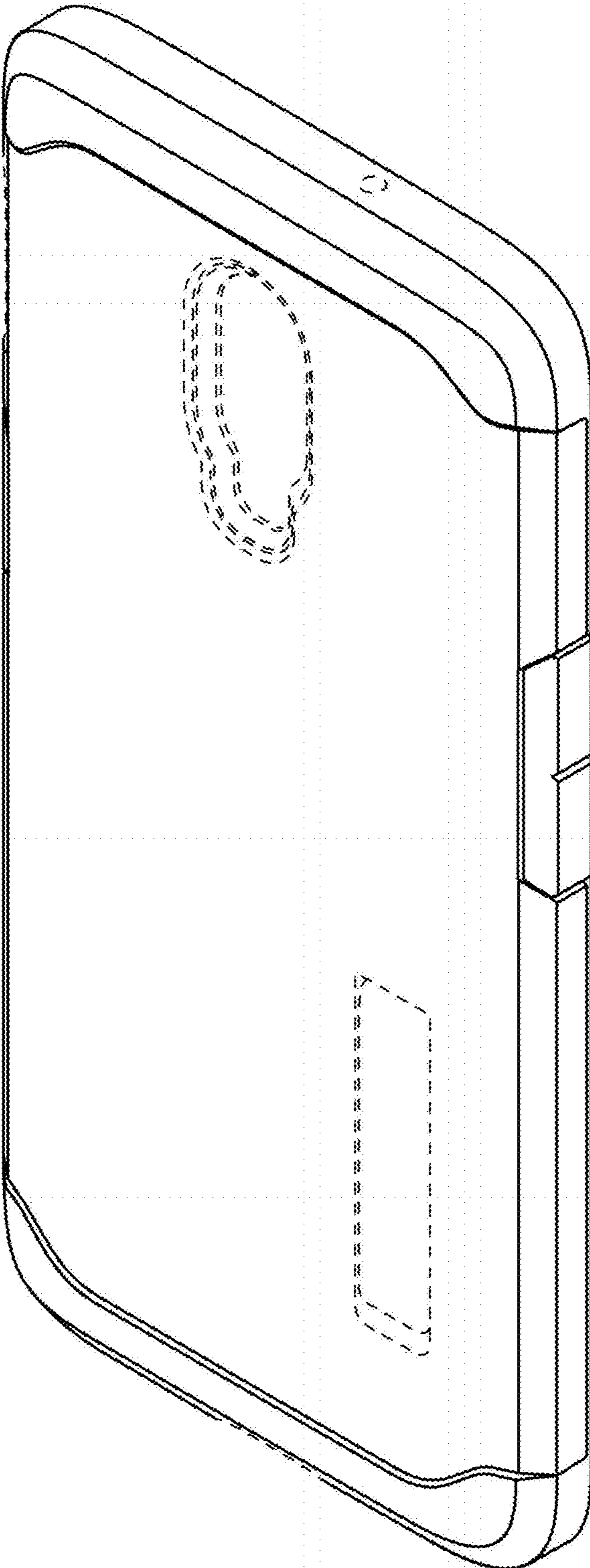

FIG. 3

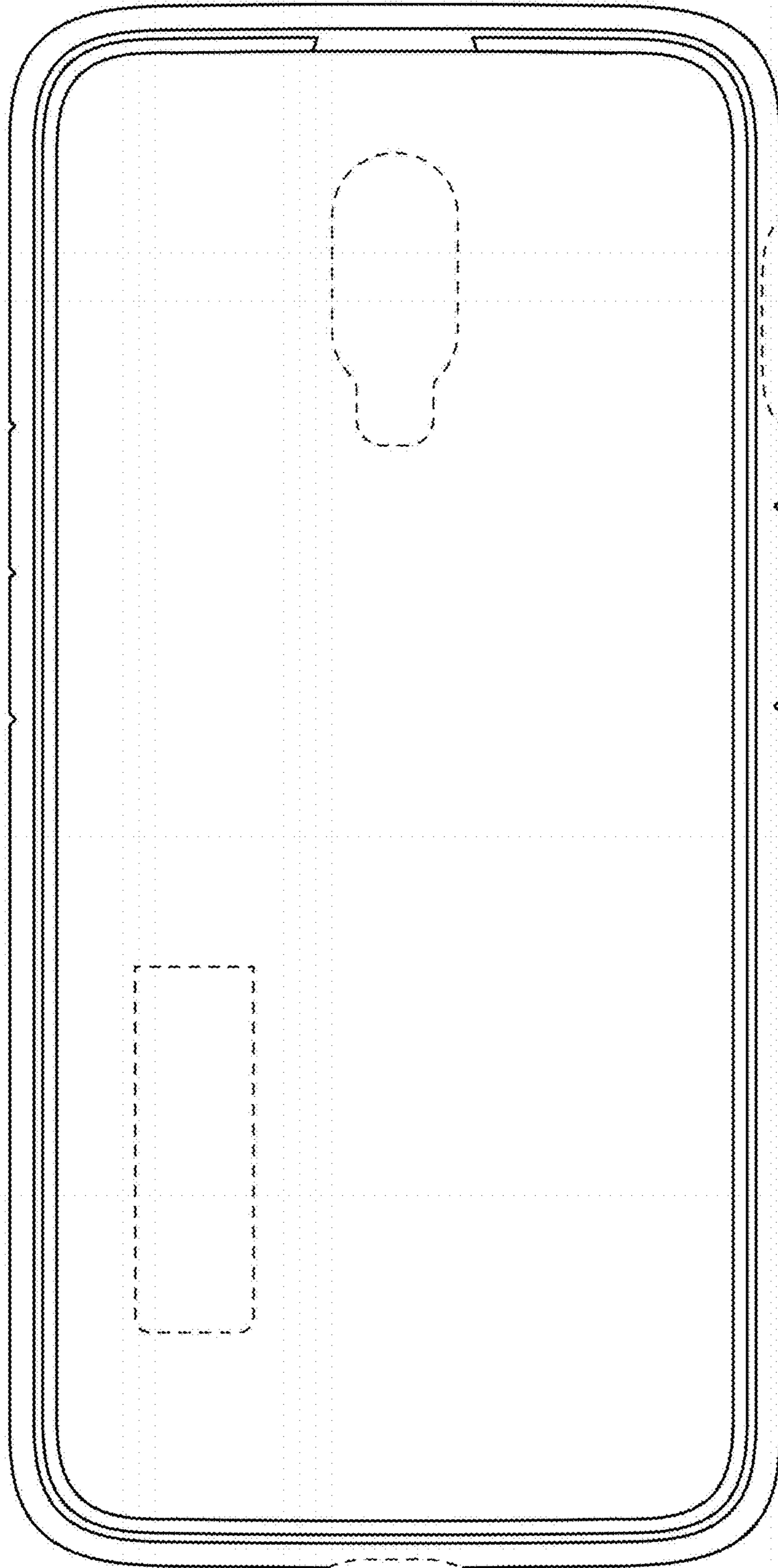

FIG. 4

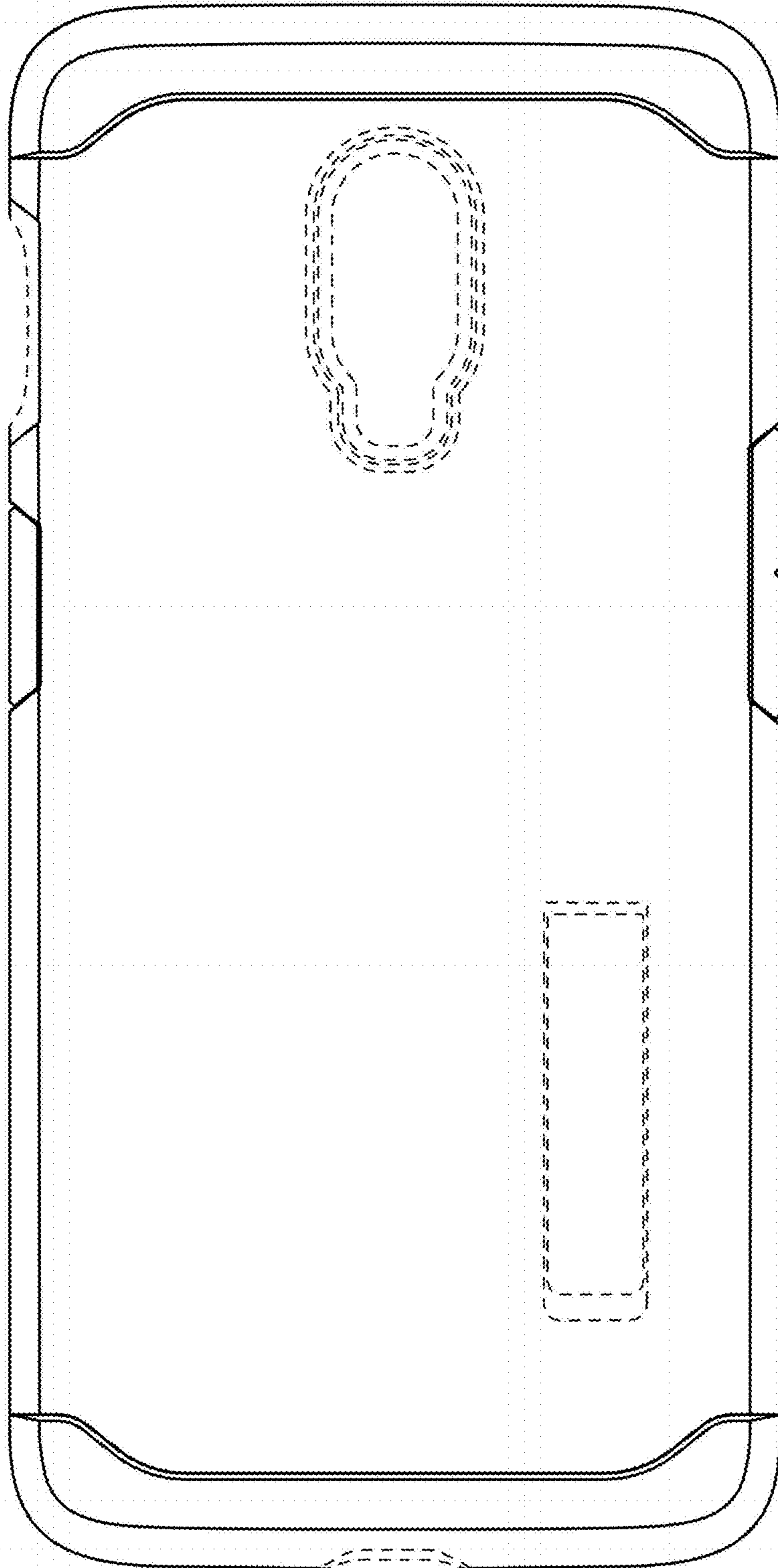

FIG. 5

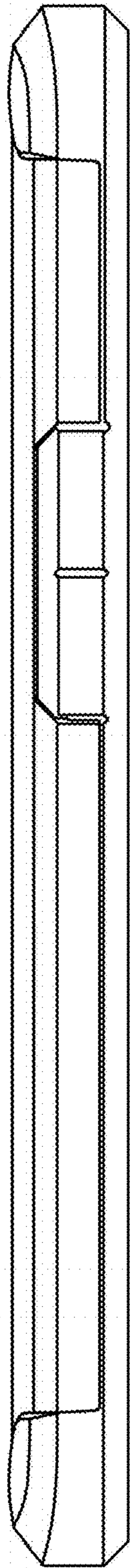

FIG. 6

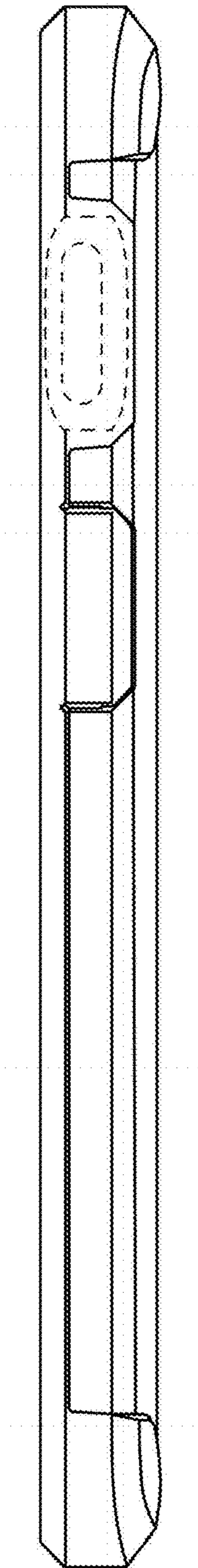

FIG. 7

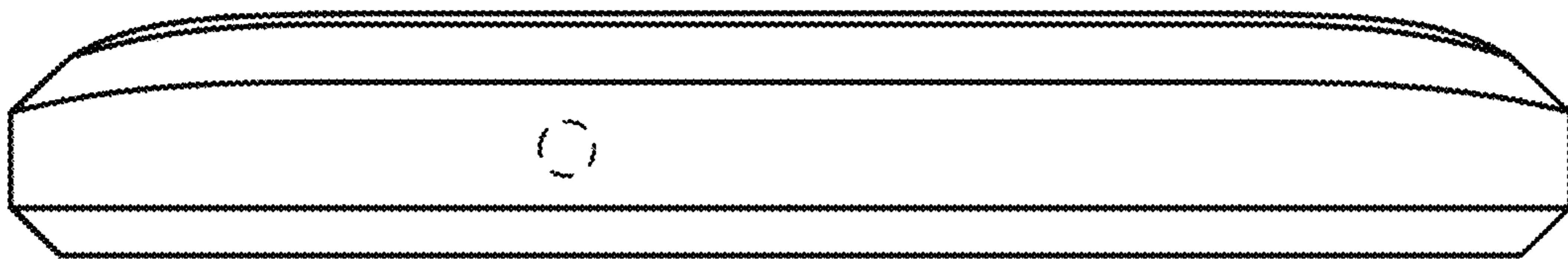

FIG. 8

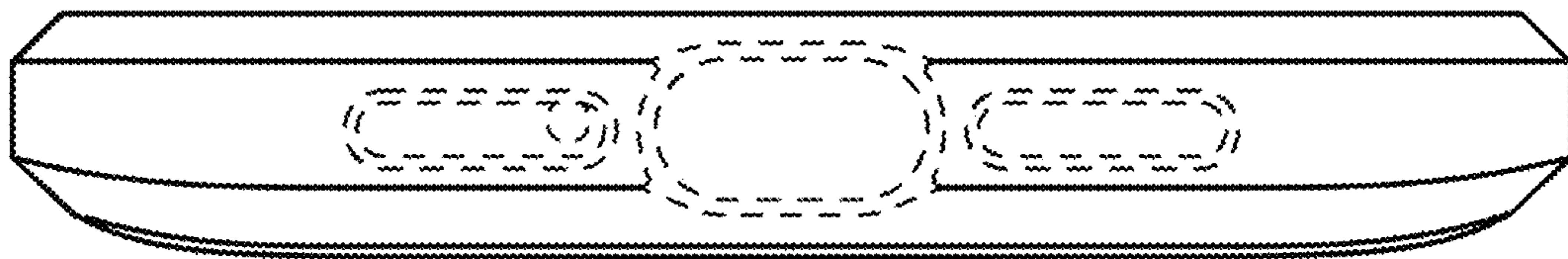

FIG. 9

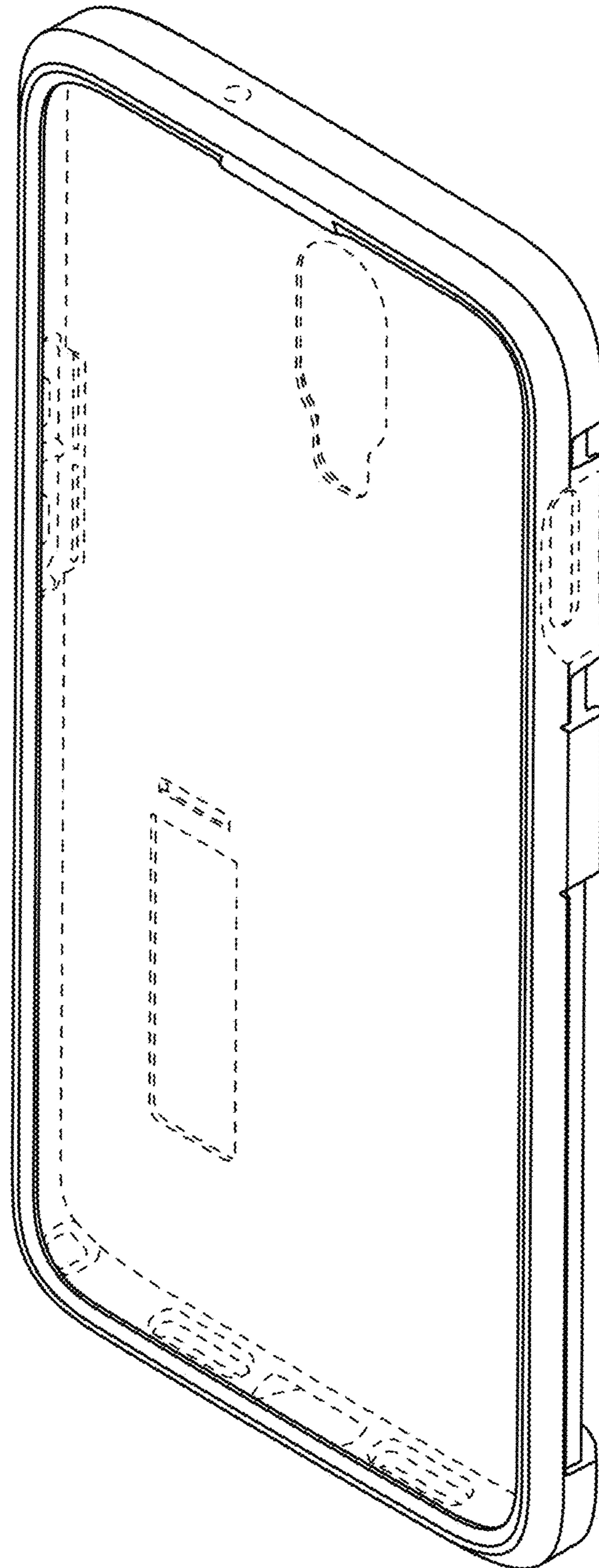

FIG. 10

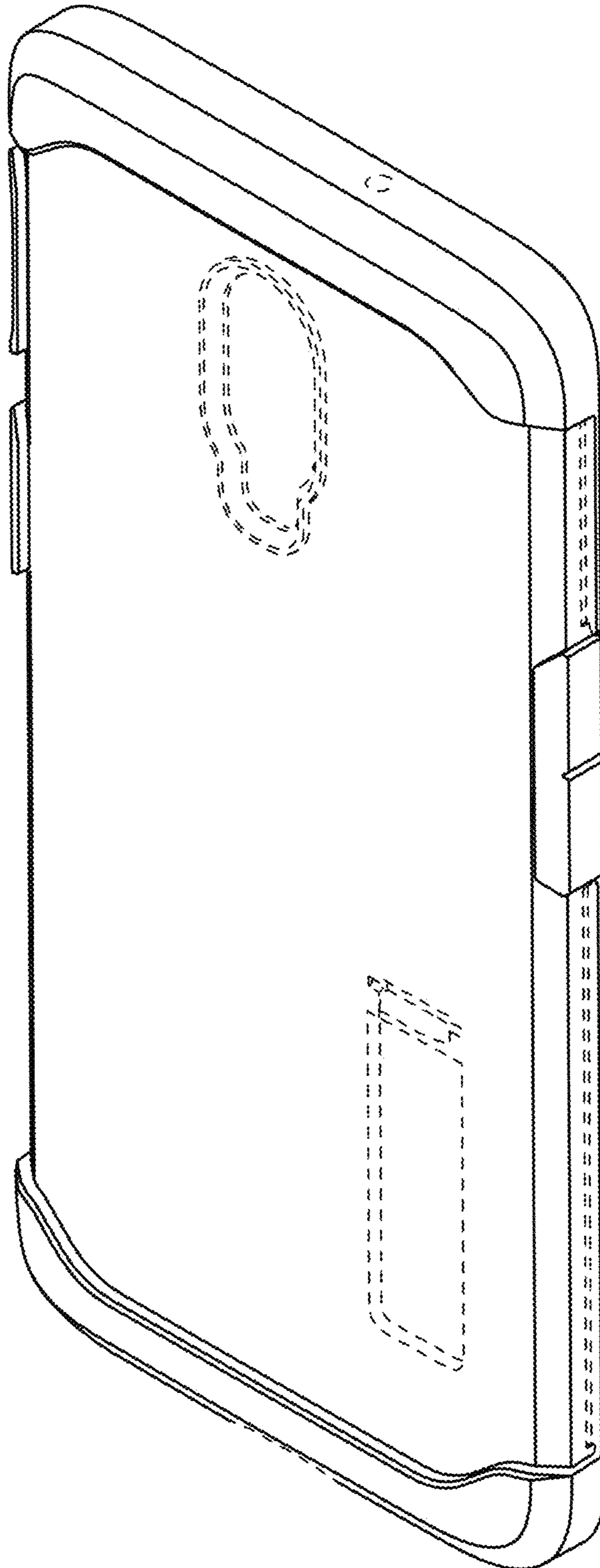

FIG. 11

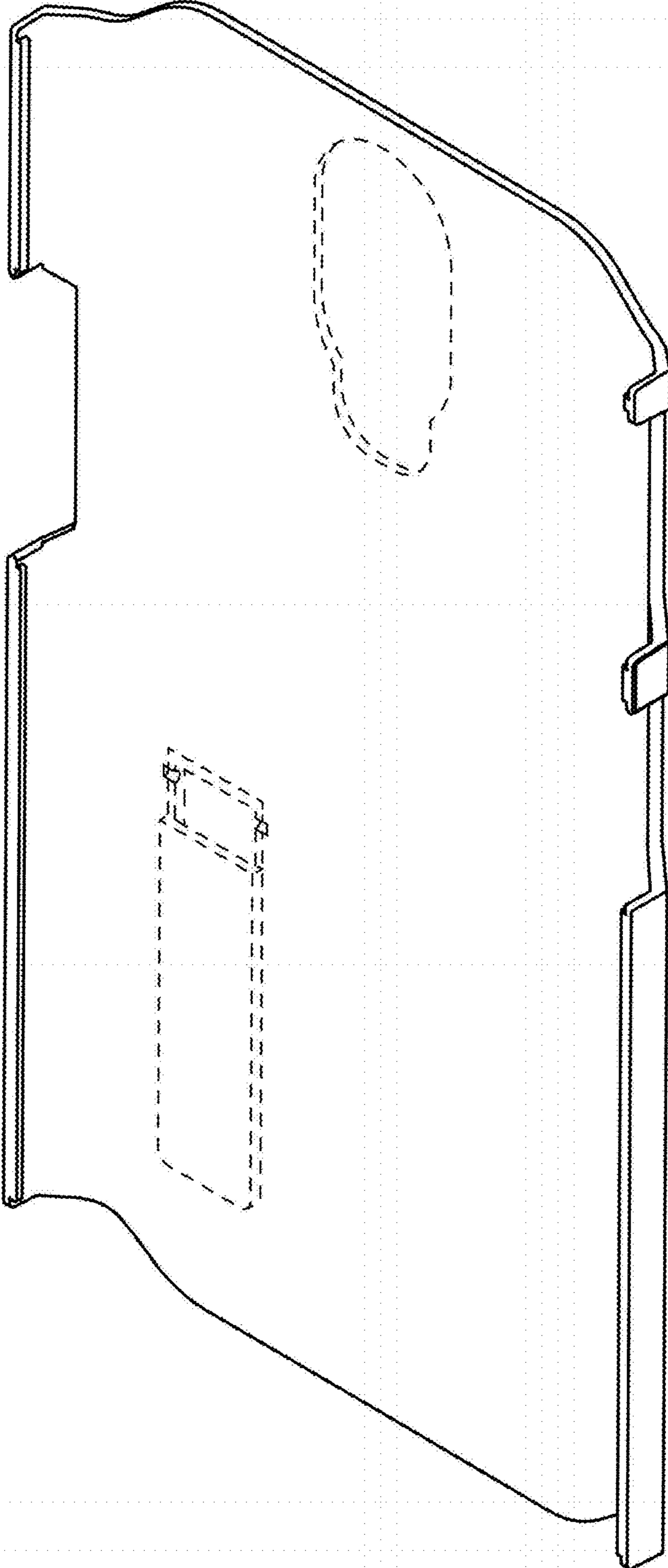

FIG. 12

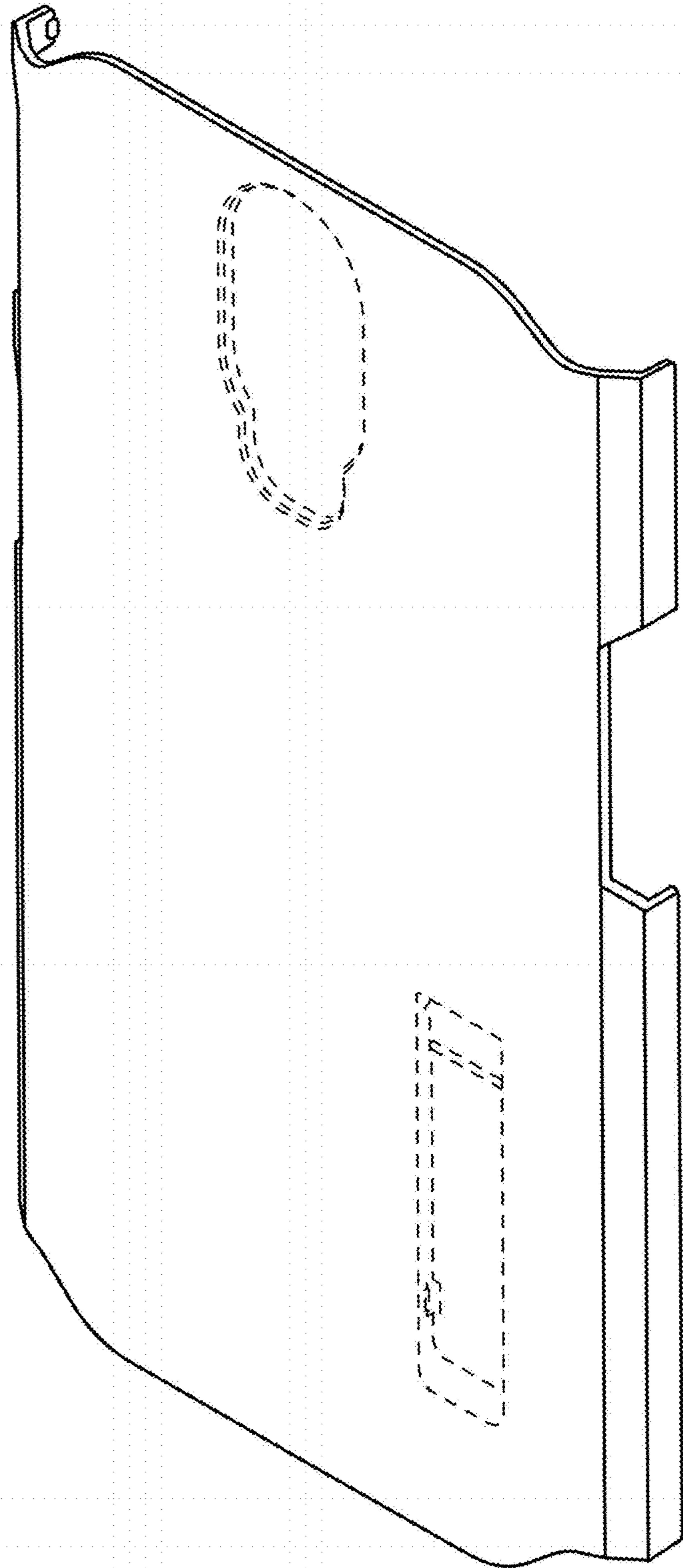

FIG. 13

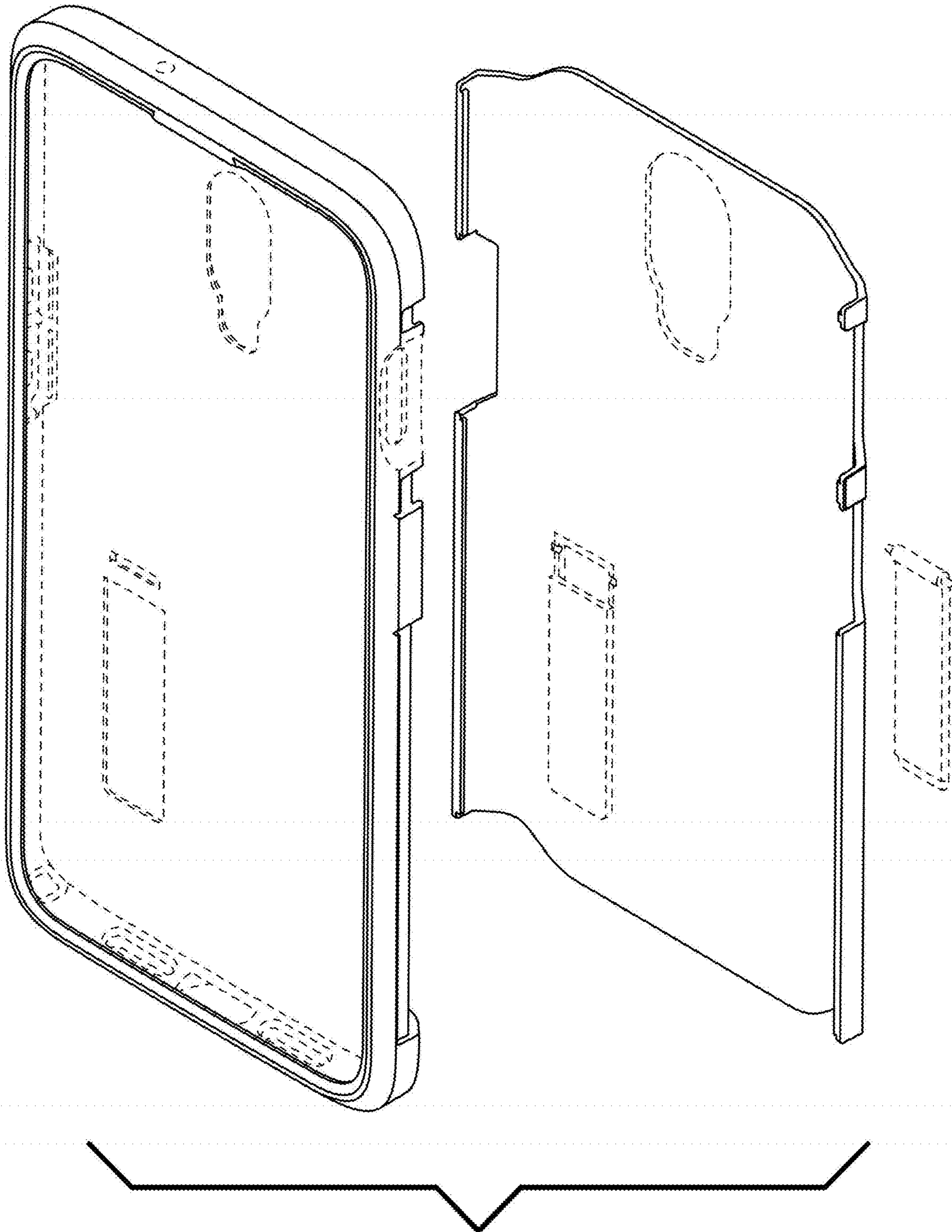

FIG. 14

