



US00D894140S

(12) **United States Design Patent**
Kim et al.

(10) **Patent No.:** **US D894,140 S**

(45) **Date of Patent:** **** Aug. 25, 2020**

(54) **TELEVISION RECEIVER**

FOREIGN PATENT DOCUMENTS

(71) Applicant: **Samsung Electronics Co., Ltd.**,
Suwon-si (KR)

CN 201630284874.4 4/2017
CN 201730053541 * 8/2017

(Continued)

(72) Inventors: **Hee-Bong Kim**, Seoul (KR); **Pilkwon Jung**, Changwon-si (KR); **Gil Jae Lee**, Seoul (KR); **Yonggu Do**, Anyang-si (KR); **Tae-Hun Kim**, Seoul (KR)

OTHER PUBLICATIONS

LG—65" Class—LED—UM6900PUA Series, (C) 2019 [online], [retrieved Apr. 17, 2020], Retrieved from internet, URL: <https://www.bestbuy.com/site/lg-65-class-led-um6900pua-series-2160p-smart-4k-uhd-tv-with-hdr/6363869.p?skuId=6363869> (Year: 2019).*

(Continued)

(73) Assignee: **Samsung Electronics Co., Ltd.**,
Suwon-si (KR)

(**) Term: **15 Years**

Primary Examiner — Barbara Fox

Assistant Examiner — Aram Kwon

(21) Appl. No.: **29/681,045**

(74) *Attorney, Agent, or Firm* — NSIP Law

(22) Filed: **Feb. 22, 2019**

(57) **CLAIM**

(30) **Foreign Application Priority Data**

We claim the ornamental design for a television receiver, as shown and described.

Aug. 29, 2018 (KR) 30-2018-0040320

DESCRIPTION

(51) **LOC (12) Cl.** **14-03**

FIG. 1 is a front perspective view of a television receiver showing our new design;

(52) **U.S. Cl.**

FIG. 2 is a front view thereof;

USPC **D14/126**; D14/125; D14/239

FIG. 3 is a rear view thereof;

(58) **Field of Classification Search**

USPC D14/126–130

FIG. 4 is a left-side view thereof;

CPC G06F 1/16; G06F 1/1601; G06F 1/1637;

FIG. 5 is a right-side view thereof;

H04N 5/64; H05K 5/0204; H05K 5/0017;

FIG. 6 is a top view thereof;

H05K 5/0217

FIG. 7 is a bottom view thereof;

See application file for complete search history.

FIG. 8 is a rear perspective view thereof;

(56) **References Cited**

FIG. 9 is an enlarged view of the encircled portion in FIG. 5; and,

U.S. PATENT DOCUMENTS

FIG. 10 is an enlarged view of the encircled portion in FIG. 8.

D700,170 S * 2/2014 Choi D14/239

The evenly-dashed broken lines illustrating portions of the television receiver form no part of the claimed design. The dot-dot-dash broken lines encircling enlargement portions of the claimed design form no part of the claimed design.

D700,187 S * 2/2014 Lee D14/451

D705,200 S * 5/2014 Choi D14/239

D725,661 S * 3/2015 Snyder D14/451

D746,825 S * 1/2016 Kang D14/451

D782,434 S * 3/2017 Kim D14/126

(Continued)

1 Claim, 8 Drawing Sheets

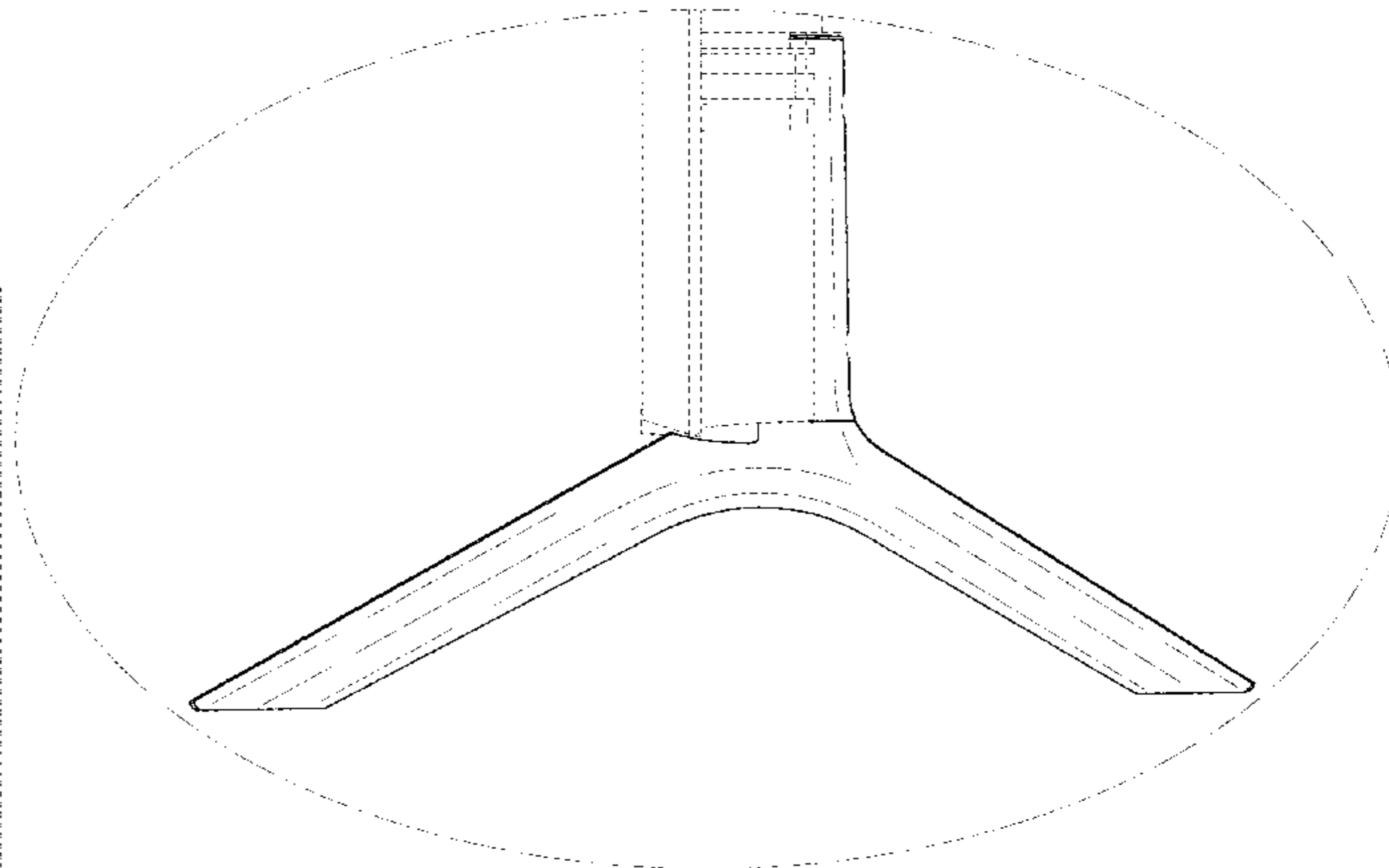
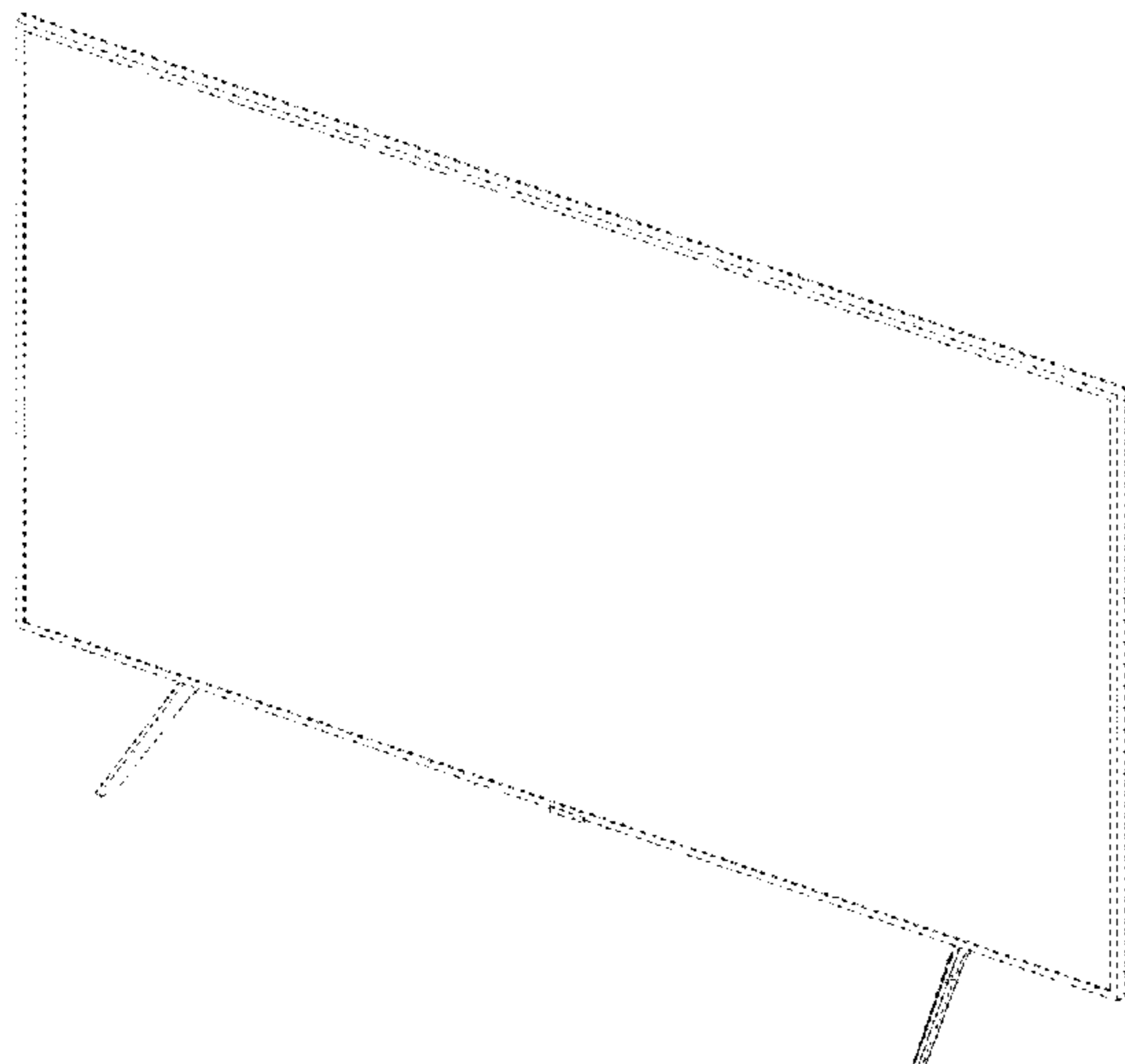

(56)

References Cited

U.S. PATENT DOCUMENTS

D784,305 S *	4/2017	Lee	D14/239
D794,620 S *	8/2017	Lee	D14/239
D797,084 S *	9/2017	Lee	D14/126
D818,999 S *	5/2018	Kim	D14/239
D821,370 S *	6/2018	Kim	D14/239
D826,915 S *	8/2018	Seo	D14/239
D848,967 S *	5/2019	Kim	D14/126
D853,365 S *	7/2019	Seong	D14/239
D855,593 S *	8/2019	Seong	D14/239
D858,470 S *	9/2019	Lee	D14/126
D858,471 S *	9/2019	Lee	D14/126
D859,338 S *	9/2019	Lim	D14/126
D865,730 S *	11/2019	Seong	D14/239
D868,713 S *	12/2019	Lee	D14/126
D875,697 S *	2/2020	Diao	D14/126
D878,314 S *	3/2020	Seong	D14/126

FOREIGN PATENT DOCUMENTS

CN	201730205822.8	11/2017
CN	201730440690.7	5/2018
CN	201730685771.3	6/2018
JP	D2019-17537	* 3/2020

KR	3020180040320	* 6/2019
WO	WOD090587-003	* 12/2016
WO	WOD201596-007	* 8/2019

OTHER PUBLICATIONS

Samsung6—43" UHD 8 Series—4K UHD TV, (C) 2020 [online], [retrieved Apr. 17, 2020], Retrieved from internet, URL: <<https://www.bestbuy.com/site/samsung-43-uhd-8-series-4k-uhd-tv-smart-led-with-hdr/6401747.p?skuId=6401747>> (Year: 2020).*

Samsung—75" Class—LED—Q60 Series, (C) 2019 [online], [retrieved Apr. 17, 2020], Retrieved from internet, URL: <<https://www.bestbuy.com/site/samsung-75-class-led-q60-series-2160p-smart-4k-uhd-tv-with-hdr/6331767.p?skuId=6331767>> (Year: 2019).*

TCL—55" Class—LED—4 Series, (C) 2019 [online], [retrieved Apr. 17, 2020], Retrieved from internet, URL: <<https://www.bestbuy.com/site/tcl-55-class-led-4-series-2160p-smart-4k-uhd-tv-with-hdr-roku-tv/6319333.p?skuId=6319333>> (Year: 2019).*

LG. “LG 43UH750T 108 cm (43 inches) 4k Ultra HD LED IPS TV (Black)” [2019] www.amazon.com Feb. 22, 2019 <<https://www.amazon.in/LG-43UH750T-inches-Ultra-Black/dp/B01GPY60LW>>.

Vu “Vu 163 Cm 65 Ultra Hd 4K Smart Led Tv 65Xt780” [2018] www.shoponn.in Feb. 22, 2019 <https://www.shoponn.in/vu_163_cm_65_ultra_hd_4k_smart_led_tv_65xt780/165390>.

* cited by examiner

FIG. 1

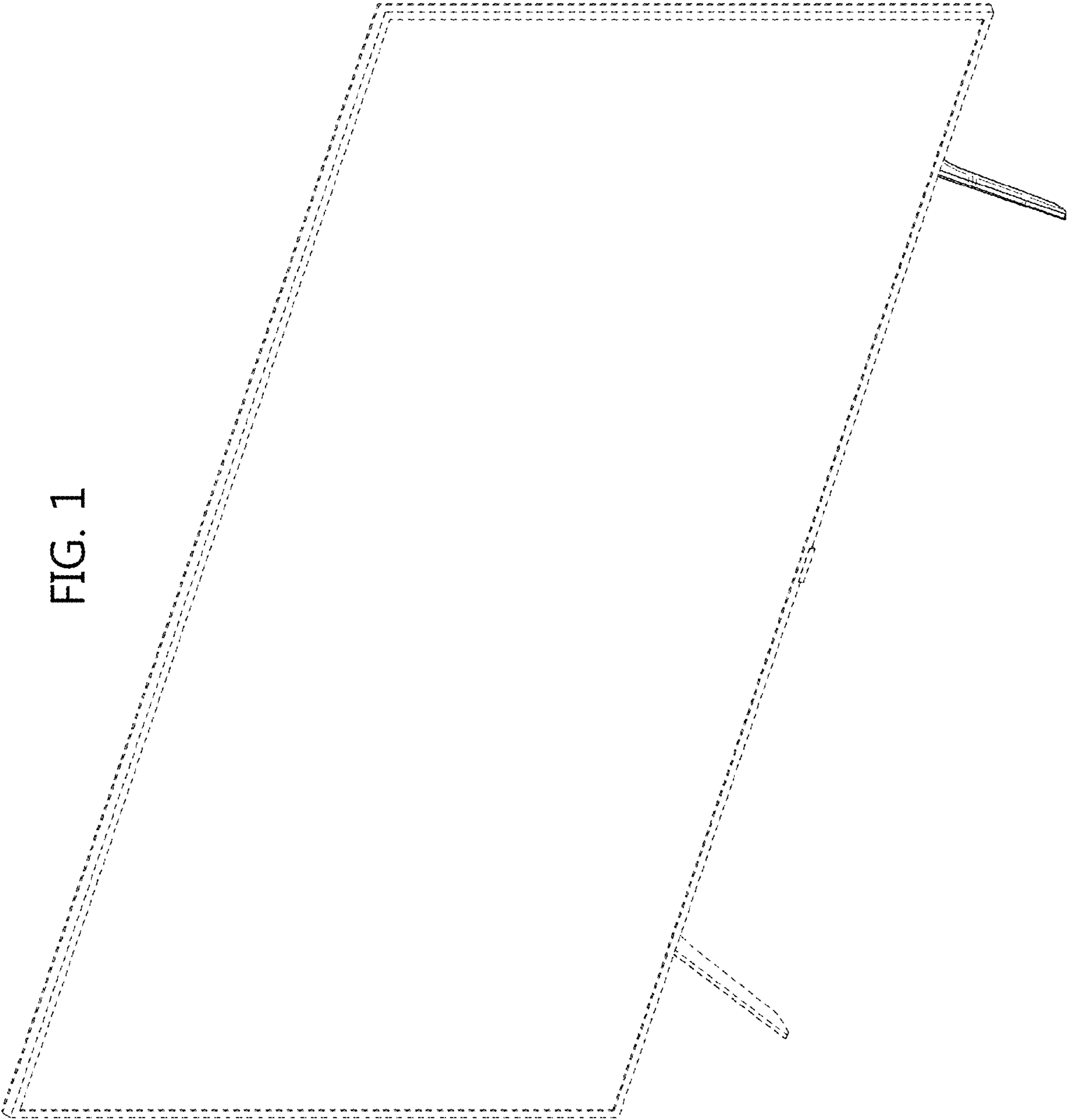

FIG. 2

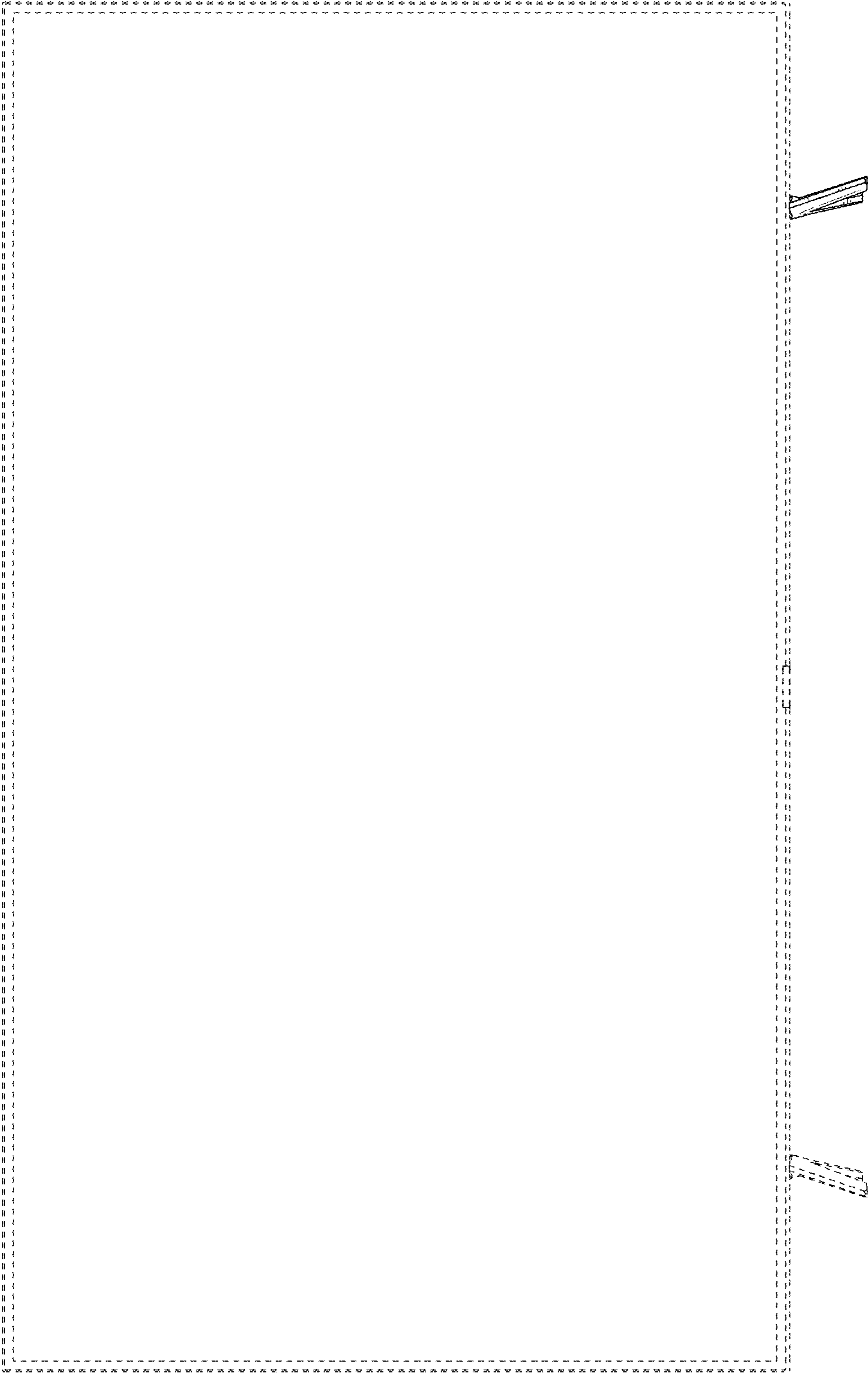

FIG. 3

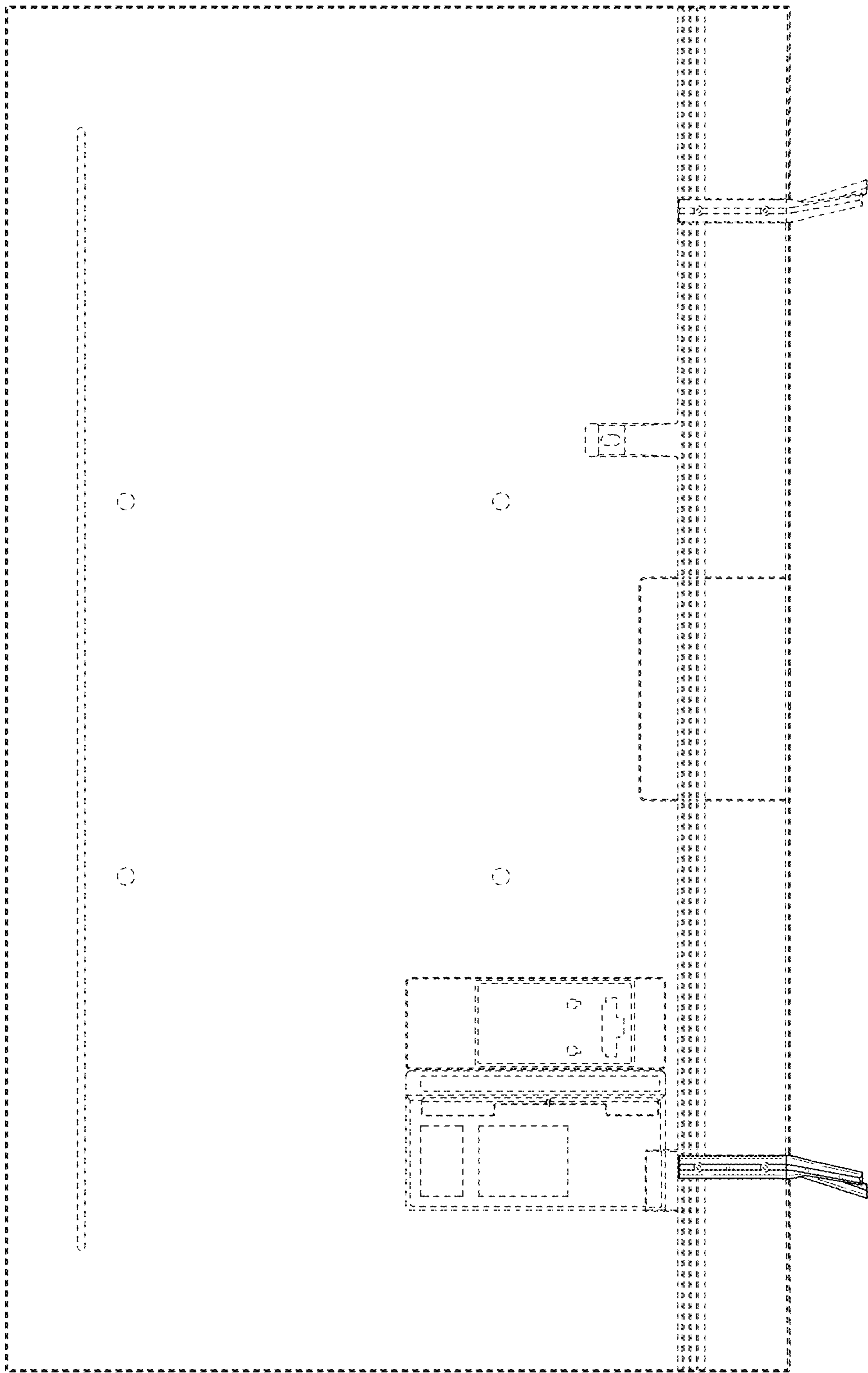

FIG. 5

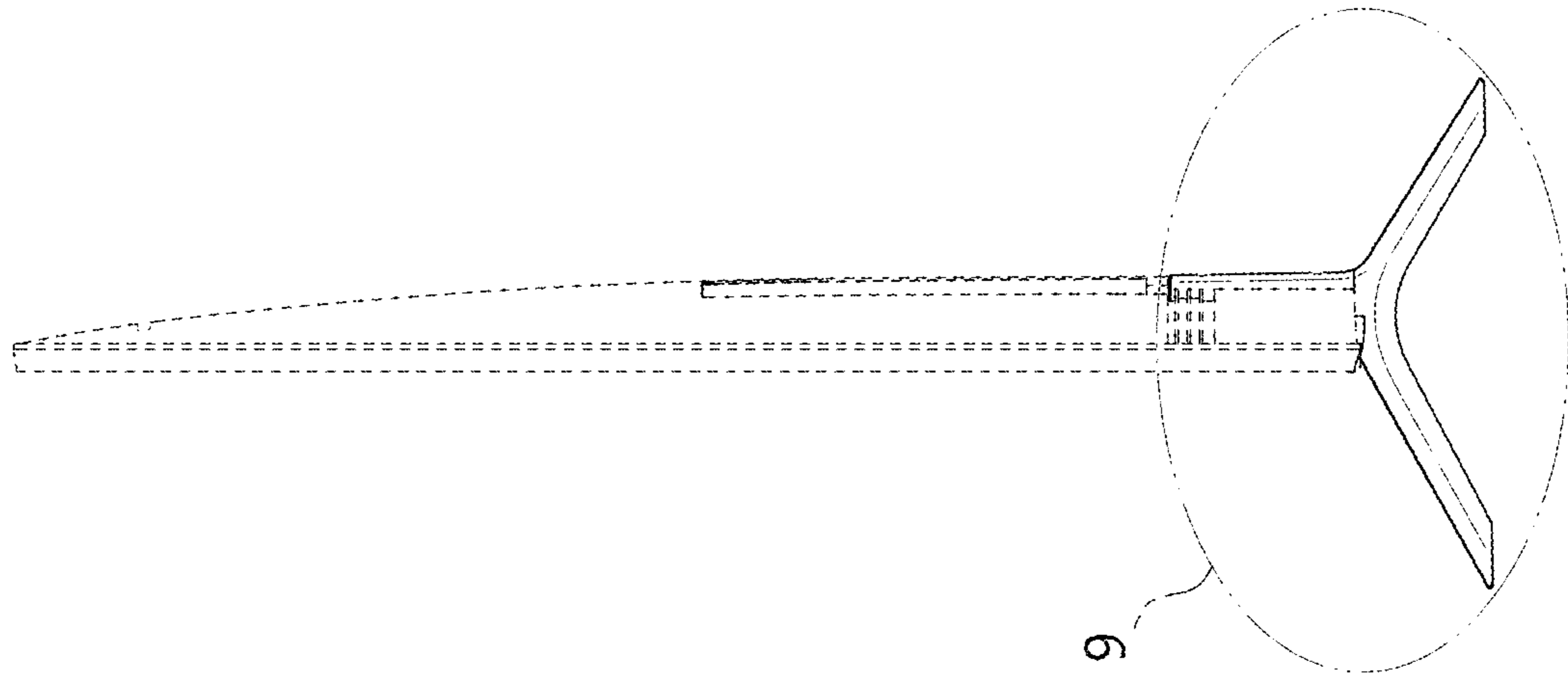

FIG. 4

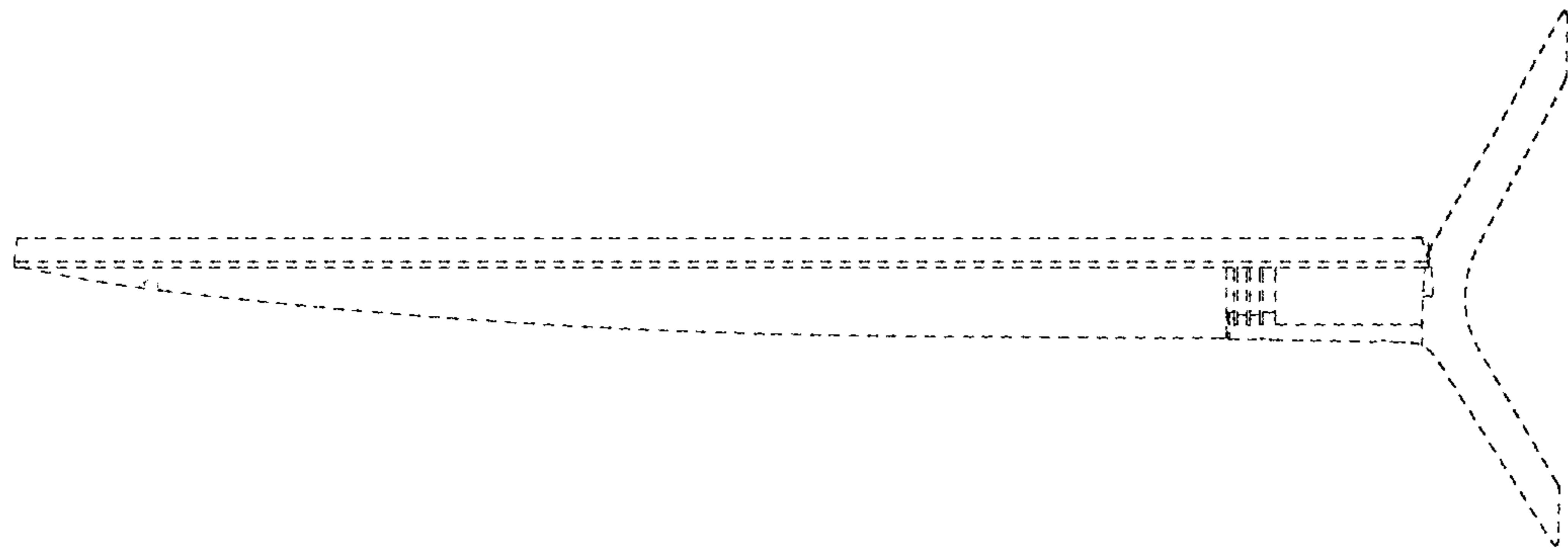

FIG. 6

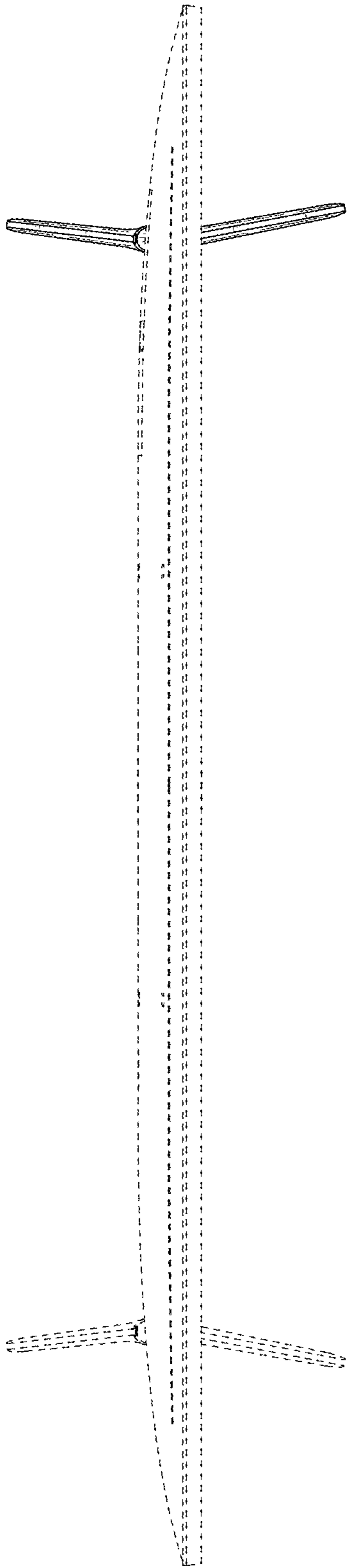

FIG. 7

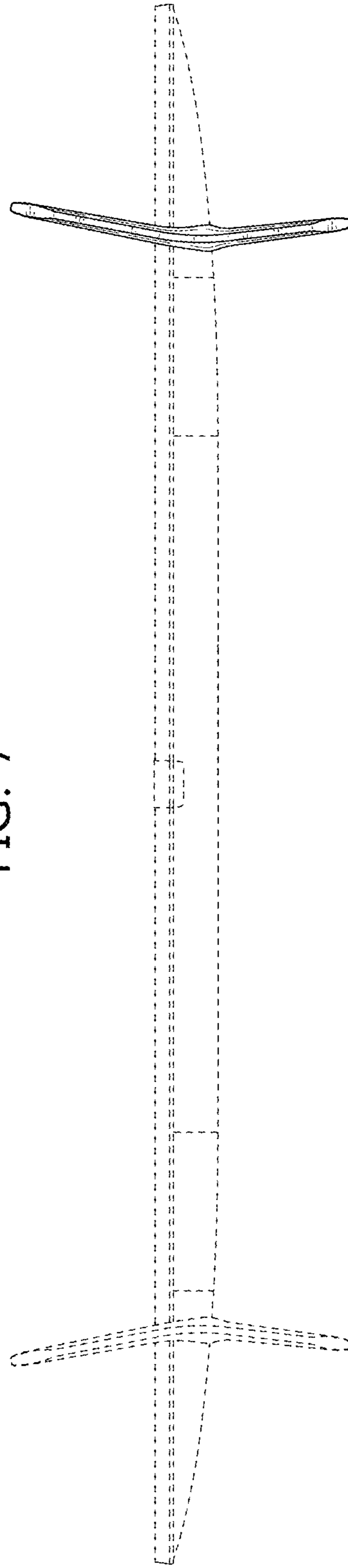

FIG. 8

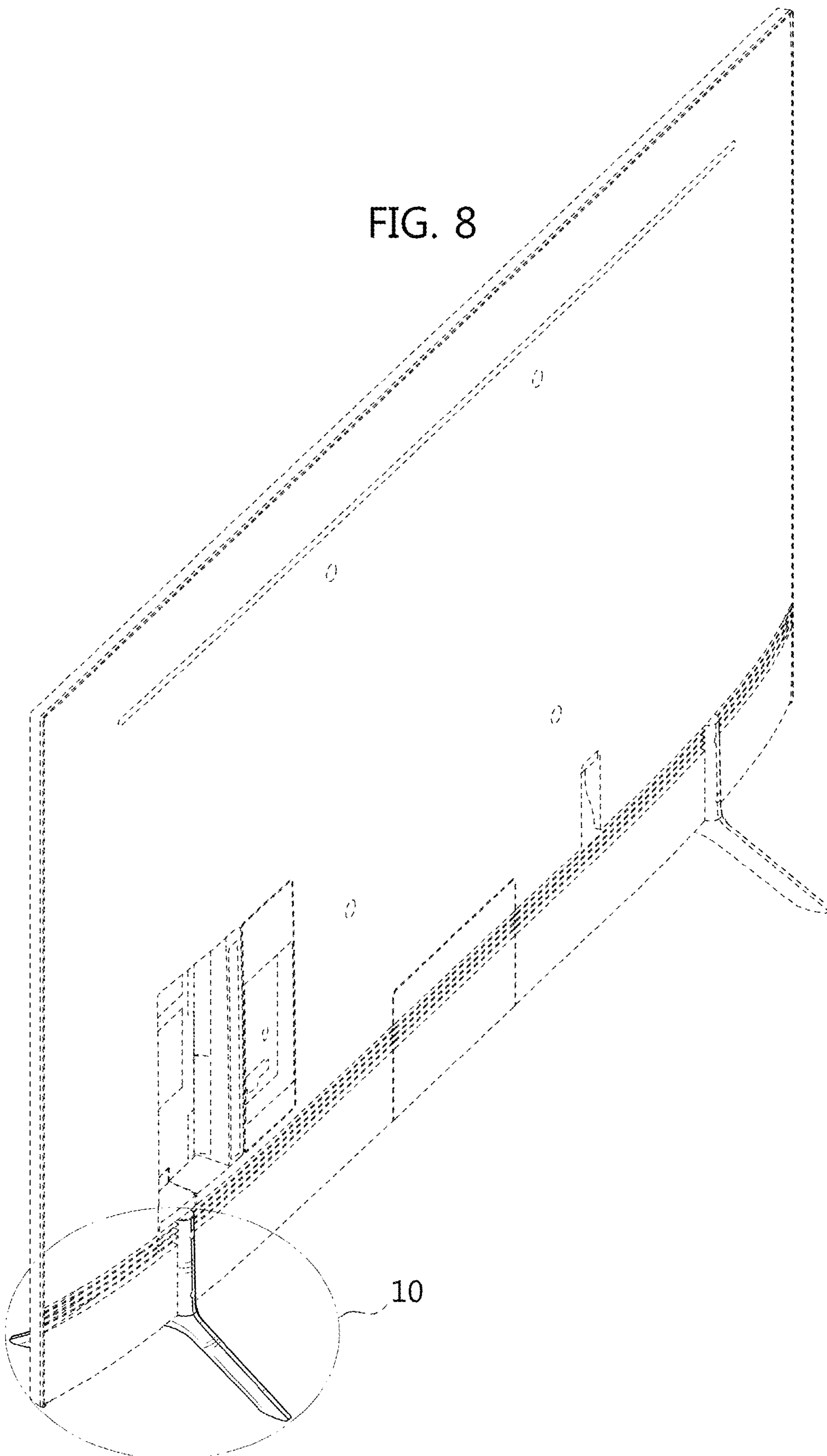

FIG. 9

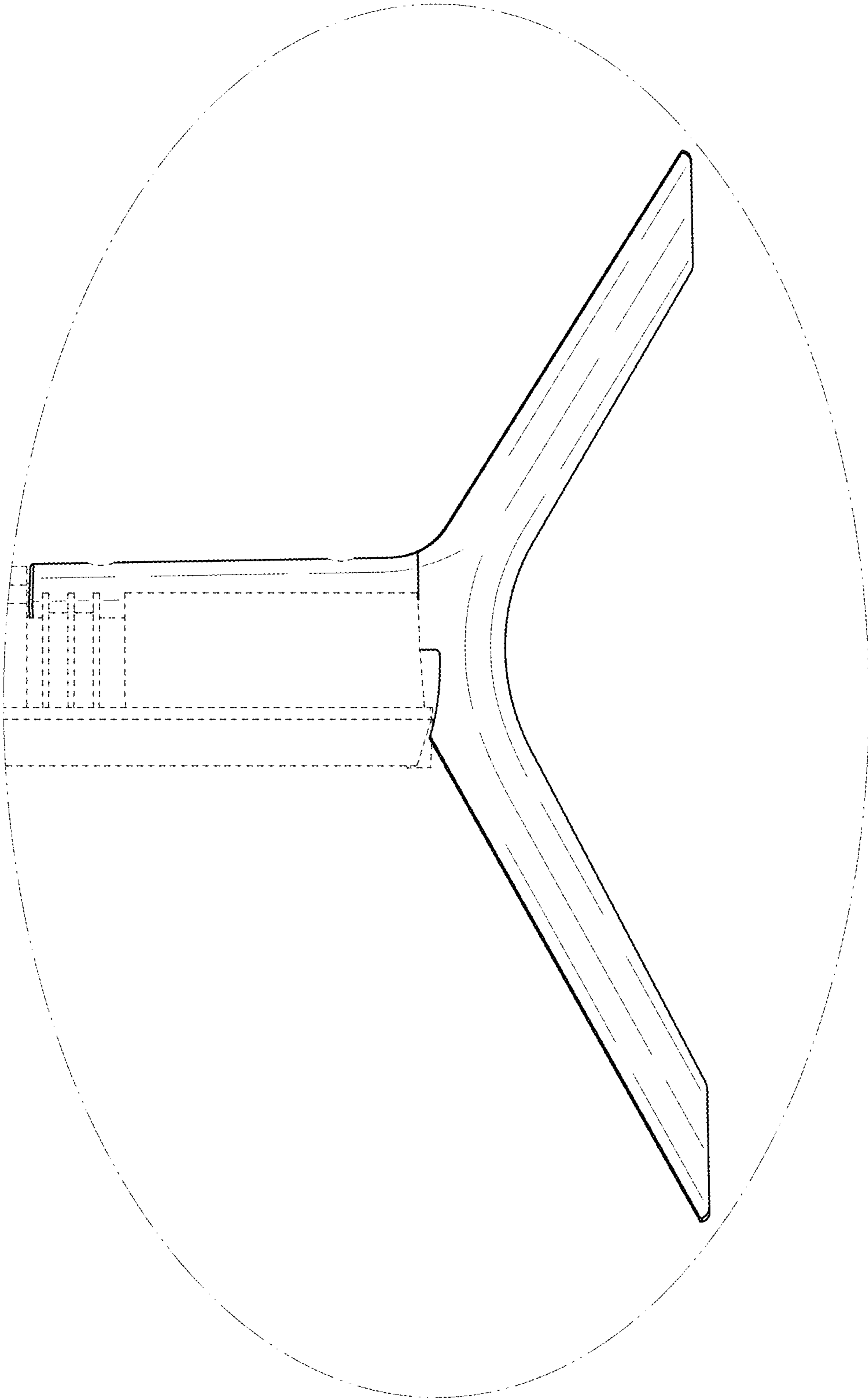

FIG. 10

