



US00D894136S

(12) **United States Design Patent**
Wu et al.

(10) **Patent No.:** **US D894,136 S**

(45) **Date of Patent:** **** Aug. 25, 2020**

- (54) **HEAT DISSIPATION DEVICE**
- (71) Applicant: **Asia Vital Components Co., Ltd.**, New Taipei (TW)
- (72) Inventors: **Chun-Ming Wu**, New Taipei (TW);
Jing-Ning Wu, New Taipei (TW);
Sheng-Pei Lee, New Taipei (TW)
- (73) Assignee: **ASIA VITAL COMPONENTS CO., LTD.**, New Taipei (TW)
- (**) Term: **15 Years**
- (21) Appl. No.: **29/644,829**
- (22) Filed: **Apr. 20, 2018**

(30) **Foreign Application Priority Data**

Mar. 26, 2018 (TW) 107301701

(51) **LOC (12) Cl.** **13-03**

(52) **U.S. Cl.**
USPC **D13/179**

(58) **Field of Classification Search**
USPC D23/386, 387, 397, 393, 403, 407, 415;
D14/230; D13/179
CPC B23P 15/26
See application file for complete search history.

(56) **References Cited**

U.S. PATENT DOCUMENTS

- D801,954 S * 11/2017 He D14/230
- D809,488 S * 2/2018 Forster D14/230
- 10,247,488 B2 * 4/2019 Lin F28F 3/02
- D865,217 S * 10/2019 McAnaw D24/231
- 10,578,368 B2 * 3/2020 Kao F28D 15/0275
- 2008/0173430 A1 * 7/2008 Jin F28D 15/0233
165/104.33
- 2008/0173431 A1 * 7/2008 Yang F28D 15/0233
165/104.33

- 2009/0016023 A1 * 1/2009 Cao F28D 15/0233
361/702
- 2014/0340264 A1 * 11/2014 Zeng H01Q 1/36
343/700 MS
- 2017/0080533 A1 * 3/2017 Lin B23P 15/26
- 2017/0151641 A1 * 6/2017 Lin B23P 15/26
- 2017/0156236 A1 * 6/2017 Lu F28D 15/00

FOREIGN PATENT DOCUMENTS

CN 304947041 * 12/2018

* cited by examiner

Primary Examiner — Karen S Acker

Assistant Examiner — Steven B Reinholdt, Jr.

(74) *Attorney, Agent, or Firm* — Thomas J. Nikolai;
DeWitt LLP

(57) **CLAIM**

The ornamental design for a heat dissipation device, as shown and described.

DESCRIPTION

FIG. 1 is a perspective view of a heat dissipation device showing our new design;
 FIG. 2 is a front view thereof;
 FIG. 3 is a rear view thereof;
 FIG. 4 is a left view thereof;
 FIG. 5 is a right view thereof;
 FIG. 6 is a top plan view thereof;
 FIG. 7 is a bottom plan view thereof; and,
 FIG. 8 is a top perspective view thereof shown in a use configuration with environment.
 The broken lines in the drawings depict portions of the heat dissipation device that form no part of claimed design. The broken lines in FIG. 8 depicting a heat radiator as environment form no part of the claimed design.

1 Claim, 8 Drawing Sheets

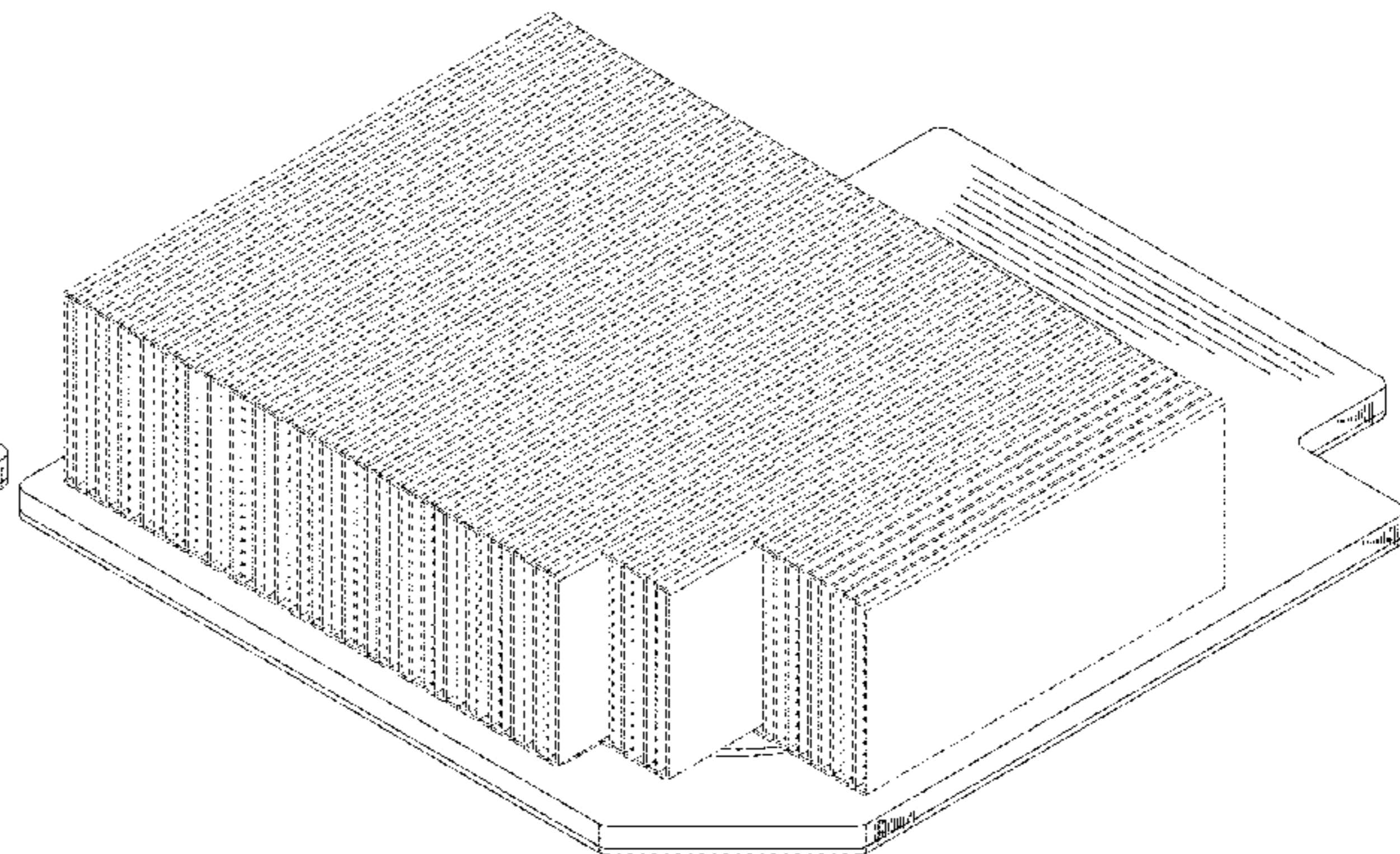
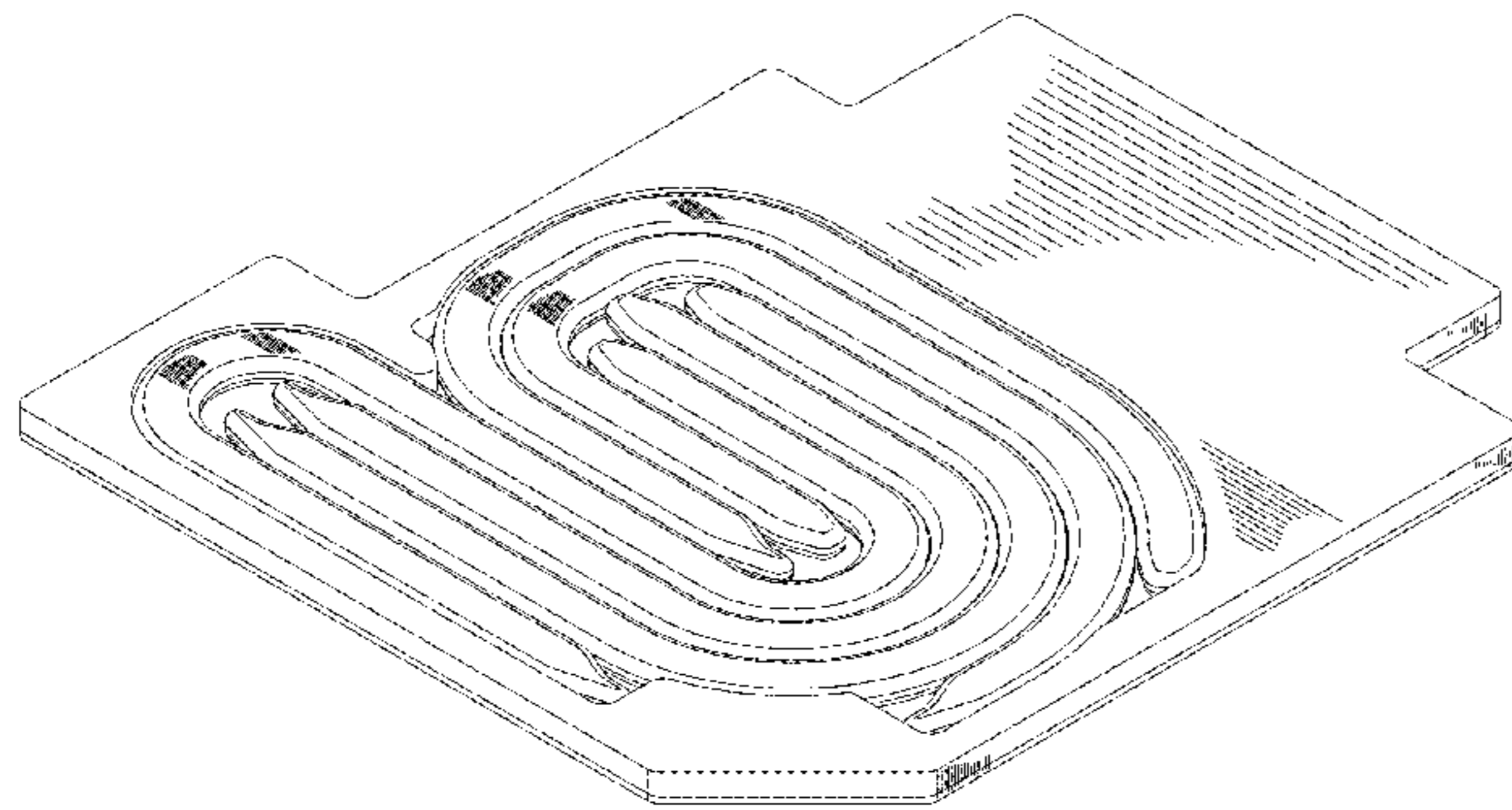

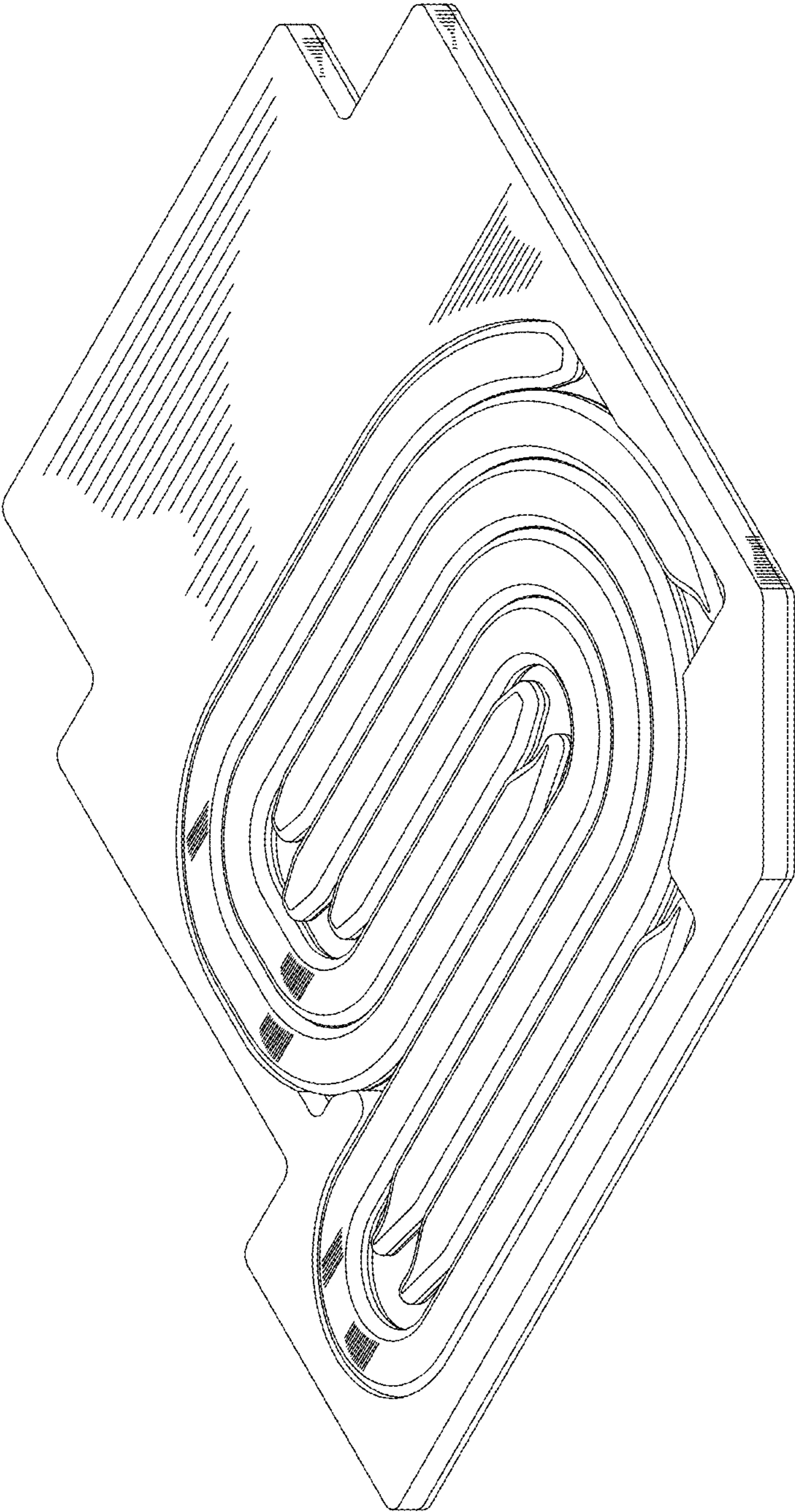

FIG. 1

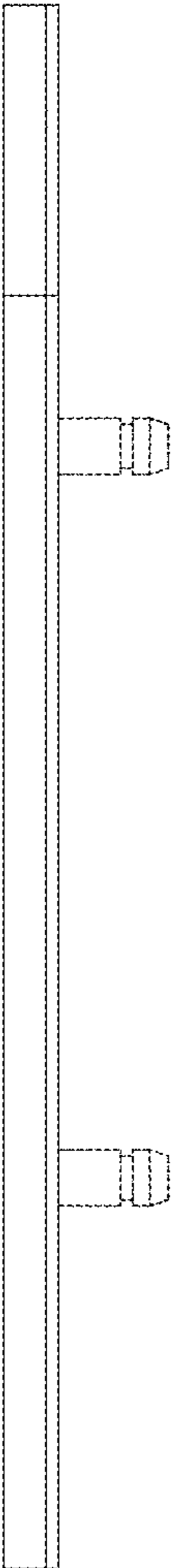

FIG. 2

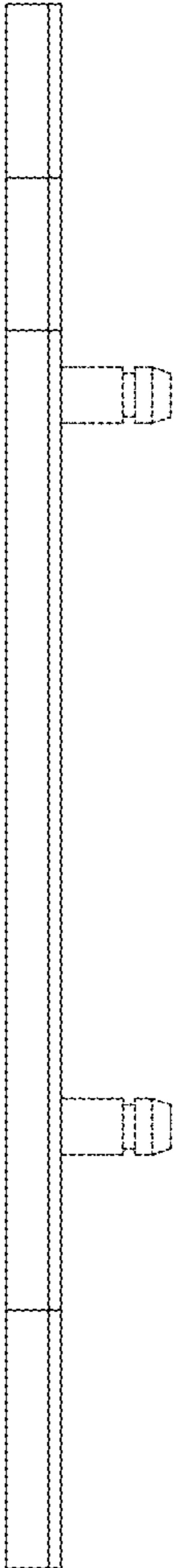

FIG. 3

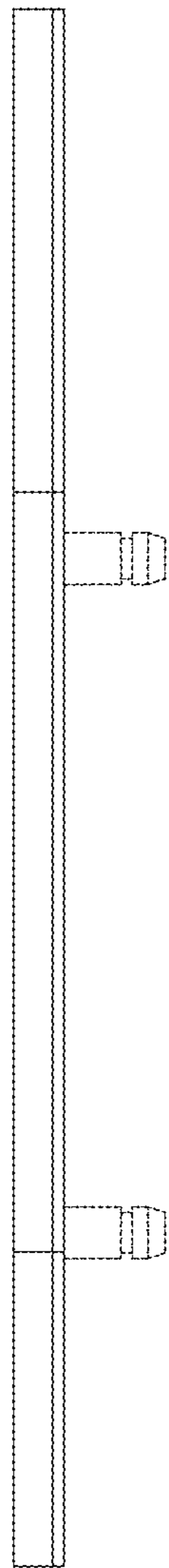

FIG. 4

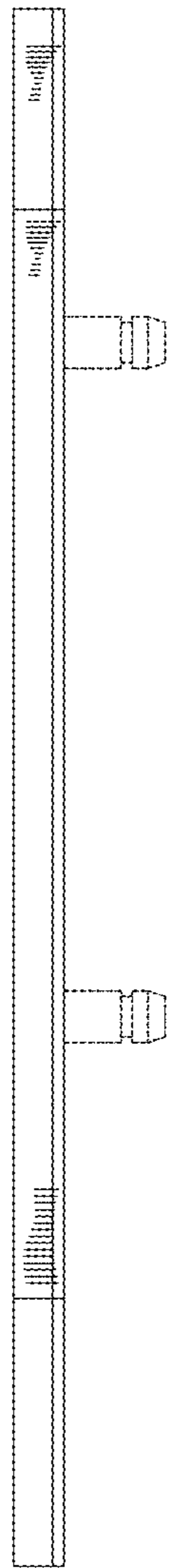

FIG. 5

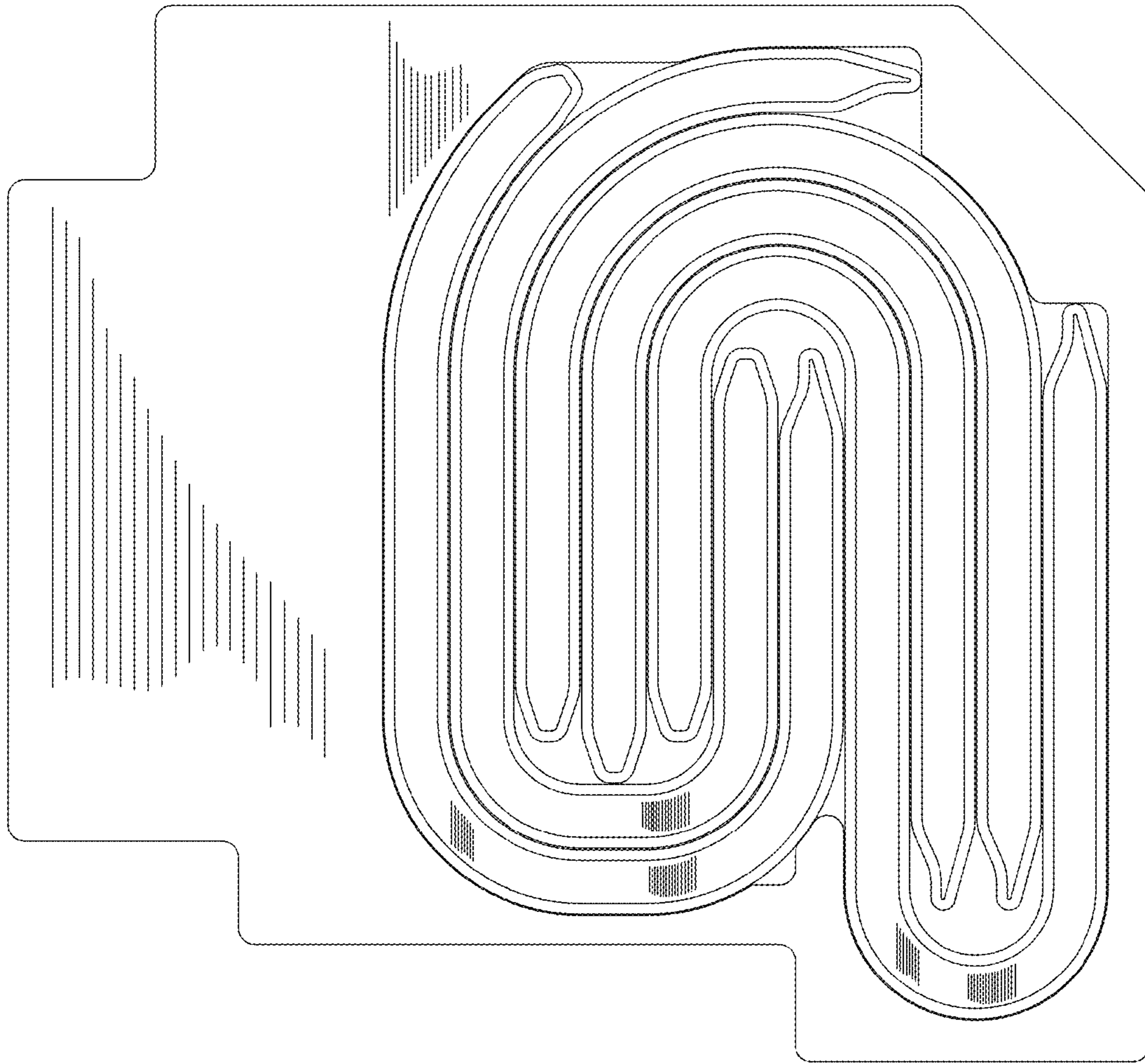

FIG. 6

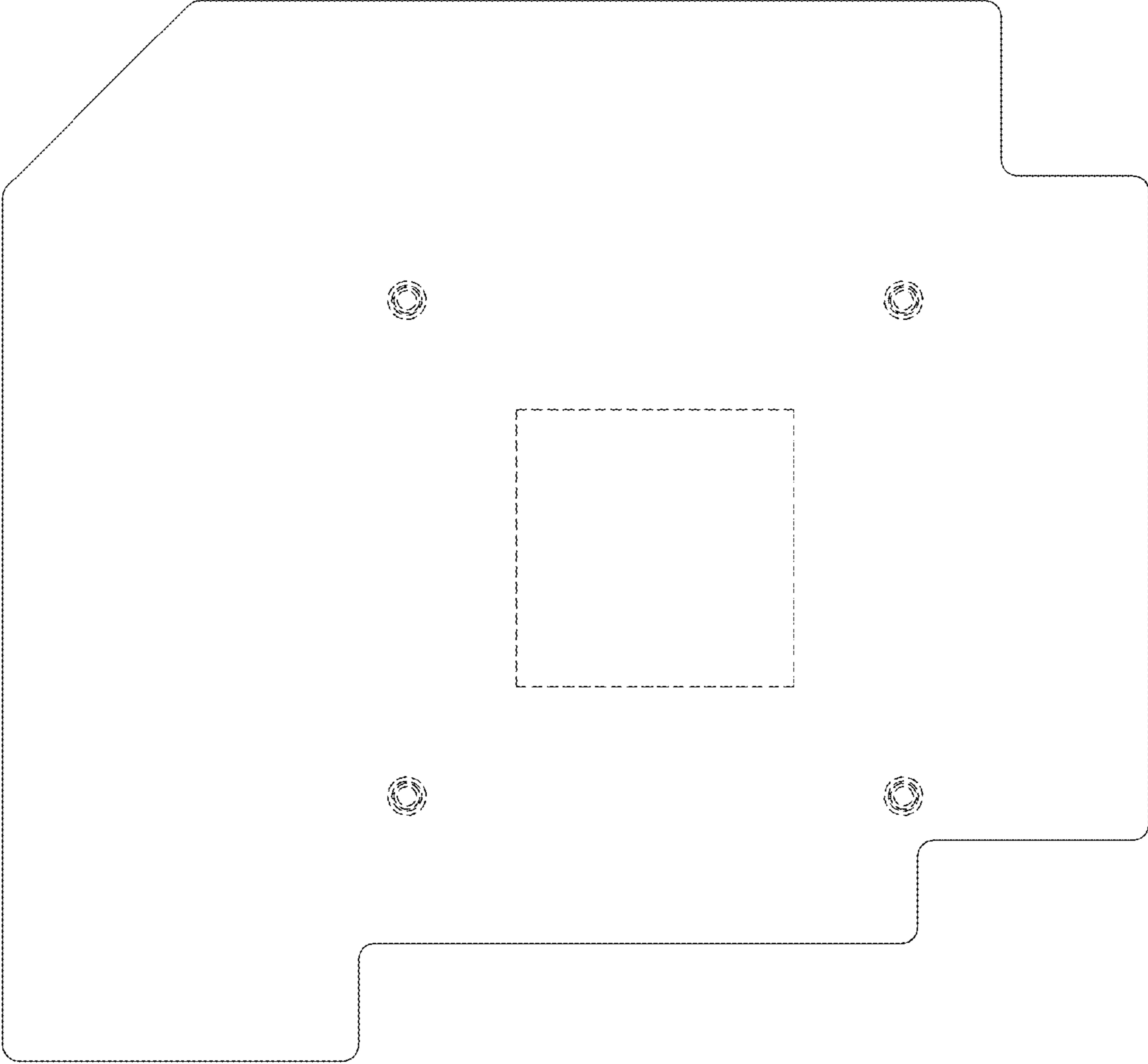

FIG. 7

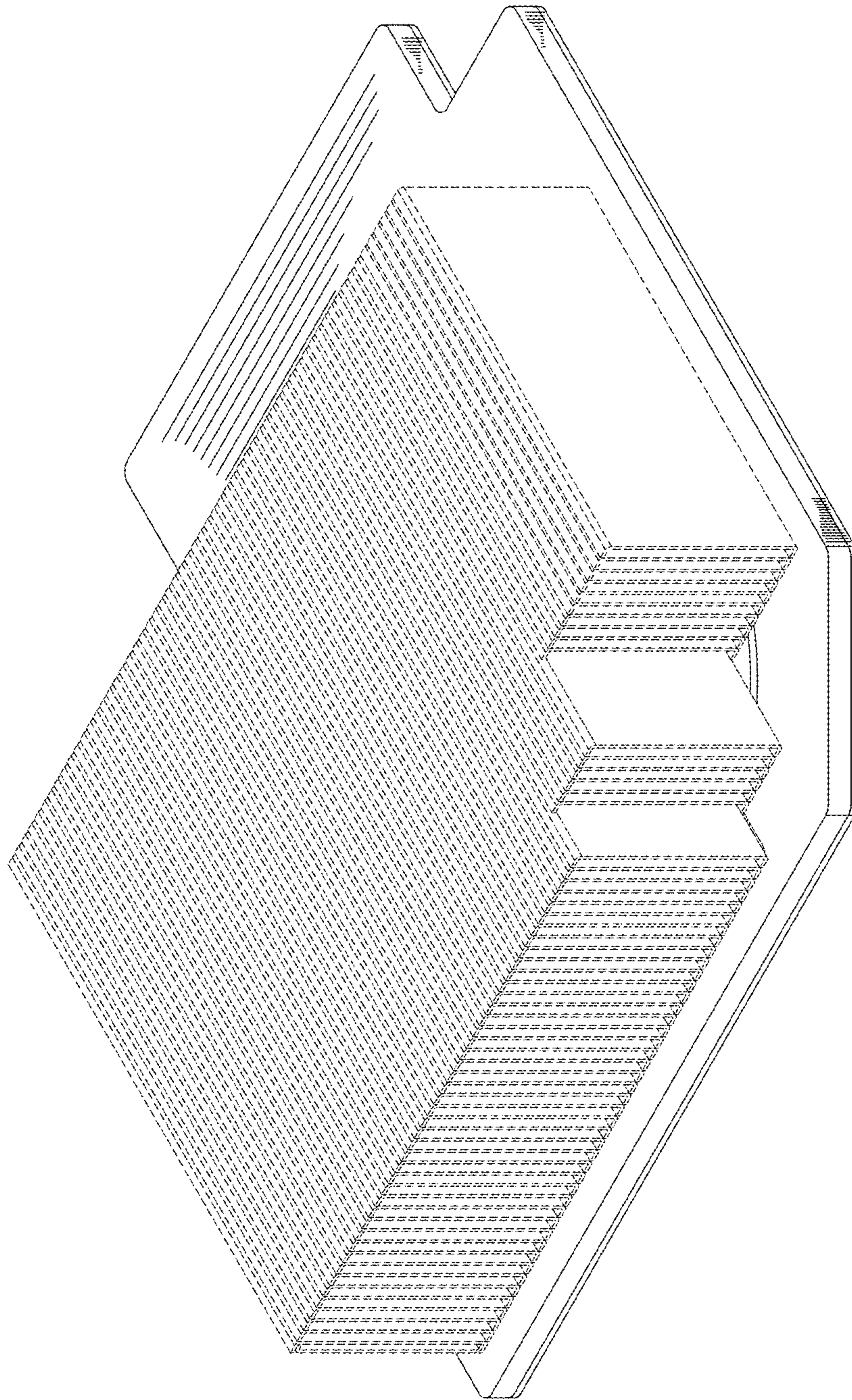

FIG. 8