



US00D894020S

(12) **United States Design Patent** (10) **Patent No.:** **US D894,020 S**
Chen et al. (45) **Date of Patent:** **** Aug. 25, 2020**

(54) **THREE-DIMENSIONAL SIGN**

(74) *Attorney, Agent, or Firm* — Botos Churchill IP Law

(71) Applicant: **Waymo LLC**, Mountain View, CA (US)

(57) **CLAIM**

The ornamental design for a three-dimensional sign, as shown and described.

(72) Inventors: **Chun Chen**, Cupertino, CA (US);
Maria Moon, Mountain View, CA (US); **YooJung Ahn**, Mountain View, CA (US)

DESCRIPTION

(73) Assignee: **Waymo LLC**, Mountain View, CA (US)

(**) Term: **15 Years**

(21) Appl. No.: **29/673,296**

(22) Filed: **Dec. 13, 2018**

(51) **LOC (12) Cl.** **10-40**

(52) **U.S. Cl.**
USPC **D10/46**; D14/432; D20/99; D25/16

(58) **Field of Classification Search**
USPC D10/46, 103; D14/432, 299; D20/99;
D25/16, 199

(Continued)

(56) **References Cited**

U.S. PATENT DOCUMENTS

9,599,477 B1 3/2017 Aula et al.
9,836,057 B2 12/2017 Fairfield et al.

(Continued)

FOREIGN PATENT DOCUMENTS

WO 2017155740 A1 9/2017
WO 2017180382 A1 10/2017

OTHER PUBLICATIONS

International Search Report and Written Opinion for Application No. PCT/US2019/053806 dated Jan. 17, 2020.

Primary Examiner — Antoine Duval Davis

FIG. 1 is a perspective view of a three-dimensional sign according to a first embodiment of our design;
FIG. 2 is a front elevation view thereof;
FIG. 3 is a back elevation view thereof;
FIG. 4 is a right side elevation view thereof;
FIG. 5 is a left side elevation view thereof;
FIG. 6 is a top plan view thereof;
FIG. 7 is a bottom plan view thereof;
FIG. 8 is a perspective view of a three-dimensional sign according to a second embodiment of our design;
FIG. 9 is a front elevation view thereof;
FIG. 10 is a back elevation view thereof;
FIG. 11 is a right side elevation view thereof;
FIG. 12 is a left side elevation view thereof;
FIG. 13 is a top plan view thereof;
FIG. 14 is a bottom plan view thereof;
FIG. 15 is a perspective view of a three-dimensional sign according to a third embodiment of our design;
FIG. 16 is a front elevation view thereof;
FIG. 17 is a back elevation view thereof;
FIG. 18 is a right side elevation view thereof;
FIG. 19 is a left side elevation view thereof;
FIG. 20 is a top plan view thereof;
FIG. 21 is a bottom plan view thereof;
FIG. 22 is a perspective view of a three-dimensional sign according to a fourth embodiment of our design;
FIG. 23 is a front elevation view thereof;
FIG. 24 is a back elevation view thereof;
FIG. 25 is a right side elevation view thereof;
FIG. 26 is a left side elevation view thereof;
FIG. 27 is a top plan view thereof;
FIG. 28 is a bottom plan view thereof;
FIG. 29 is a front perspective view of a three-dimensional sign according to a fifth embodiment of our design;
FIG. 30 is a front elevation view thereof;

(Continued)

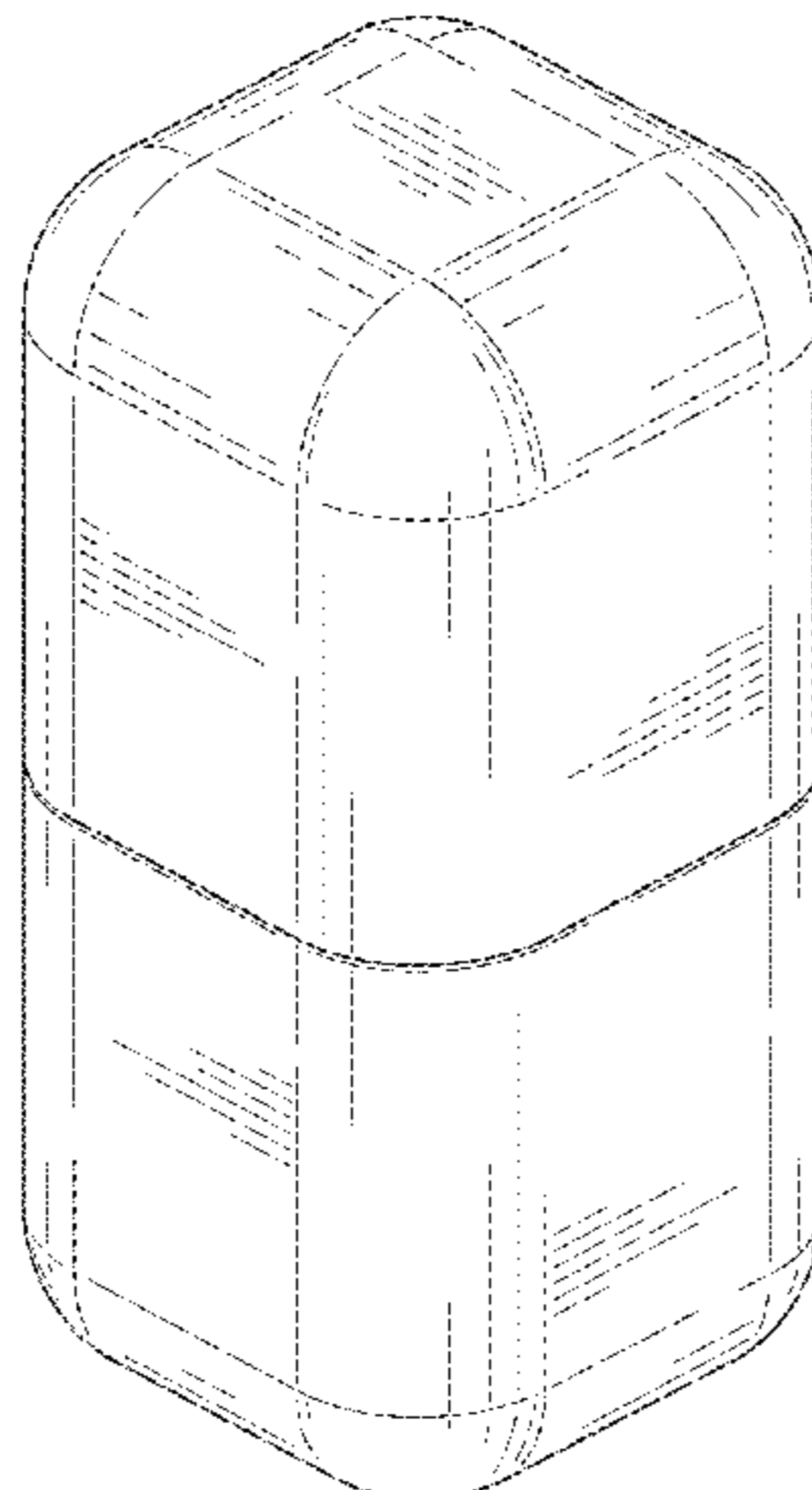

FIG. 31 is a back elevation view thereof;
 FIG. 32 is a right side elevation view thereof;
 FIG. 33 is a left side elevation view thereof;
 FIG. 34 is a top plan view thereof;
 FIG. 35 is a bottom plan view thereof;
 FIG. 36 is a rear perspective view thereof;
 FIG. 37 is a perspective view of a three-dimensional according to a sixth embodiment of our design;
 FIG. 38 is a front elevation view thereof;
 FIG. 39 is a back elevation view thereof;
 FIG. 40 is a right side elevation view thereof;
 FIG. 41 is a left side elevation view thereof;
 FIG. 42 is a top plan view thereof;
 FIG. 43 is a bottom plan view thereof;
 FIG. 44 is a perspective view of a three-dimensional sign according to a seventh embodiment of our design;
 FIG. 45 is a front elevation view thereof;
 FIG. 46 is a back elevation view thereof;
 FIG. 47 is a right side elevation view thereof;
 FIG. 48 is a left side elevation view thereof;
 FIG. 49 is a top plan view thereof;
 FIG. 50 is a bottom plan view thereof;
 FIG. 51 is a perspective view of a three-dimensional sign according to any of the first through fifth embodiments, illustrated in an exemplary scenario;
 FIG. 52 is a perspective view of a three-dimensional sign according to a ninth embodiment of our design;
 FIG. 53 is a front elevation view thereof;
 FIG. 54 is a back elevation view thereof;
 FIG. 55 is a right side elevation view thereof;
 FIG. 56 is a left side elevation view thereof;
 FIG. 57 is a top plan view thereof; and,
 FIG. 58 is a bottom plan view thereof.

The broken lines illustrate portions of the three-dimensional sign that form no part of the claimed design. The exemplary individuals shown in broken lines in FIG. 51 form no part of the claimed design. The specific placement of the individuals in FIG. 51 is for illustrative purposes only. The text in broke lines in FIGS. 15, 19, 29, 33, 34 and 36 also forms no part of the claimed design.

The portions in FIGS. 37-43 shown in a pattern of stipple illustrate areas of contrasting appearance.

In FIGS. 44-50, the lines of varying length emanating from the three-dimensional sign are shown to indicate illumination. The intensity, color(s), and/or pattern(s) of illumination, and the lines of varying length themselves, form no part of the claimed design.

1 Claim, 36 Drawing Sheets

(58) **Field of Classification Search**

CPC G06K 9/00671; G06K 9/00711; G06K 2209/23; H04B 17/373; H04B 17/27; H04B 17/318; G06T 19/006; G06Q 30/0645; G06Q 10/02; G06Q 50/30; G01C 21/3407; G01C 21/362; G01C 21/3438; G05D 1/0276; G05D 1/0291; G05D 2201/0213; G05D 1/0212; G05D 1/0088; B60R 25/24; G08G 1/202; G08G 1/005; H04W 4/029

See application file for complete search history.

(56) **References Cited**

U.S. PATENT DOCUMENTS

9,875,589	B1	1/2018	Buttolo et al.	
D831,148	S *	10/2018	Ferrara	D21/838
10,290,074	B2	5/2019	Sweeney et al.	
10,401,858	B2	9/2019	Pandit et al.	
10,535,271	B1	1/2020	Dyer et al.	
2015/0241878	A1	8/2015	Crombez et al.	
2015/0339928	A1	11/2015	Ramanujam	
2016/0370194	A1	12/2016	Colijn et al.	
2017/0075358	A1	3/2017	Zhang	
2017/0147959	A1	5/2017	Sweeney et al.	
2017/0213308	A1	7/2017	Wellborn et al.	
2017/0277191	A1	9/2017	Fairfield et al.	
2017/0344010	A1	11/2017	Rander et al.	
2017/0370734	A1	12/2017	Colijn et al.	
2018/0202822	A1	7/2018	Delizio	
2018/0342035	A1	11/2018	Sweeney et al.	
2019/0065852	A1	2/2019	Badalamenti et al.	

* cited by examiner

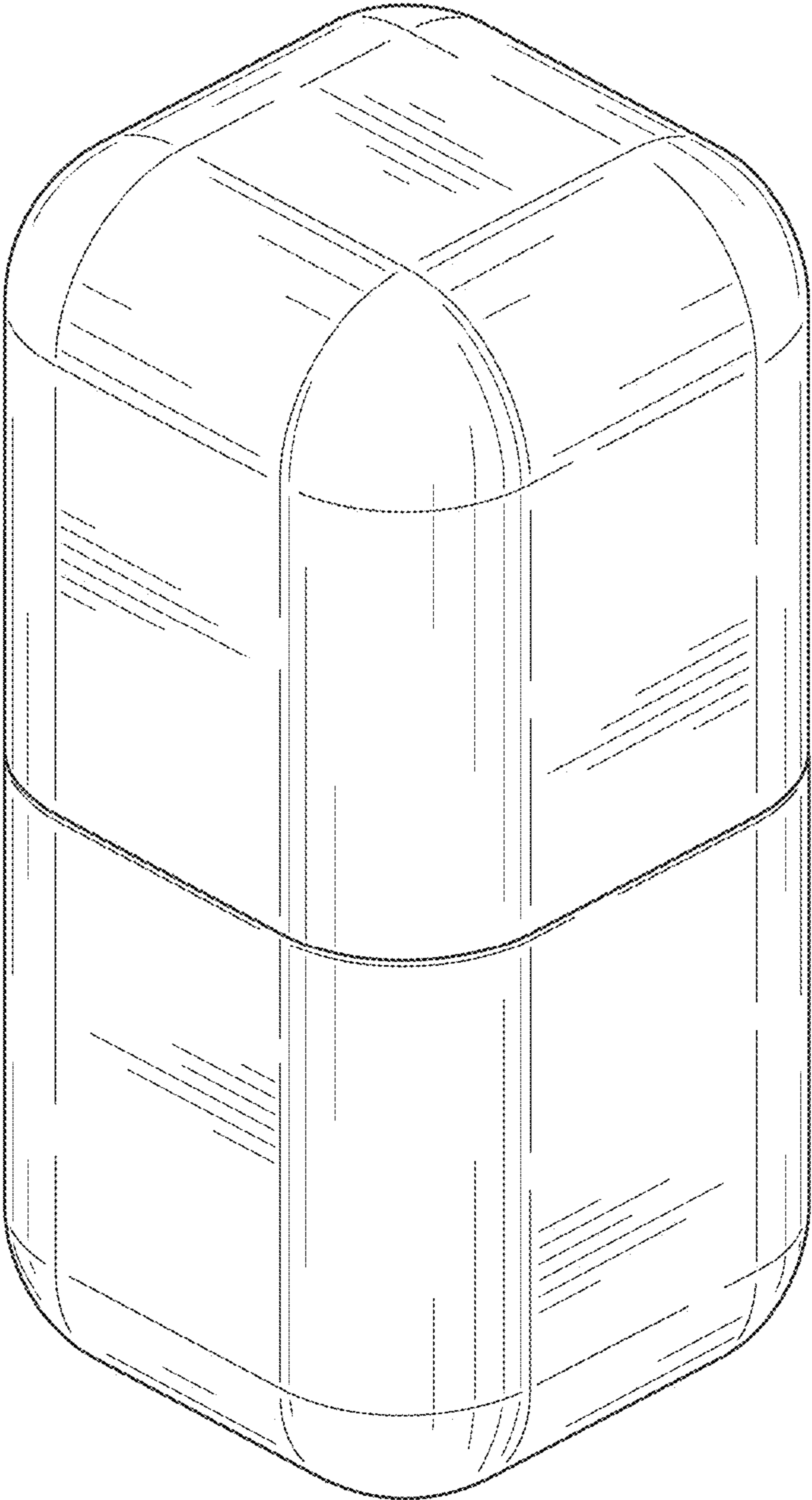

FIG. 1

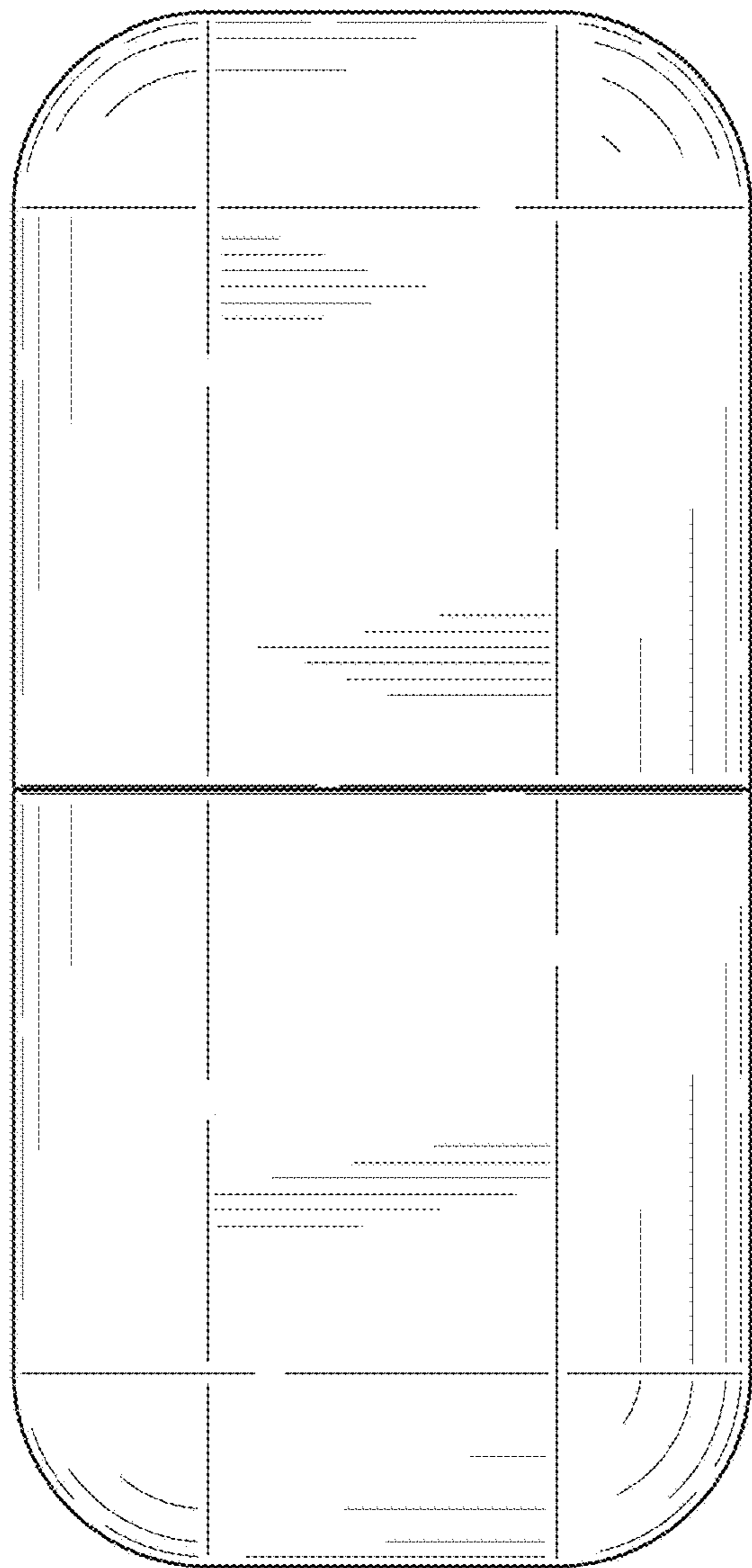

FIG. 2

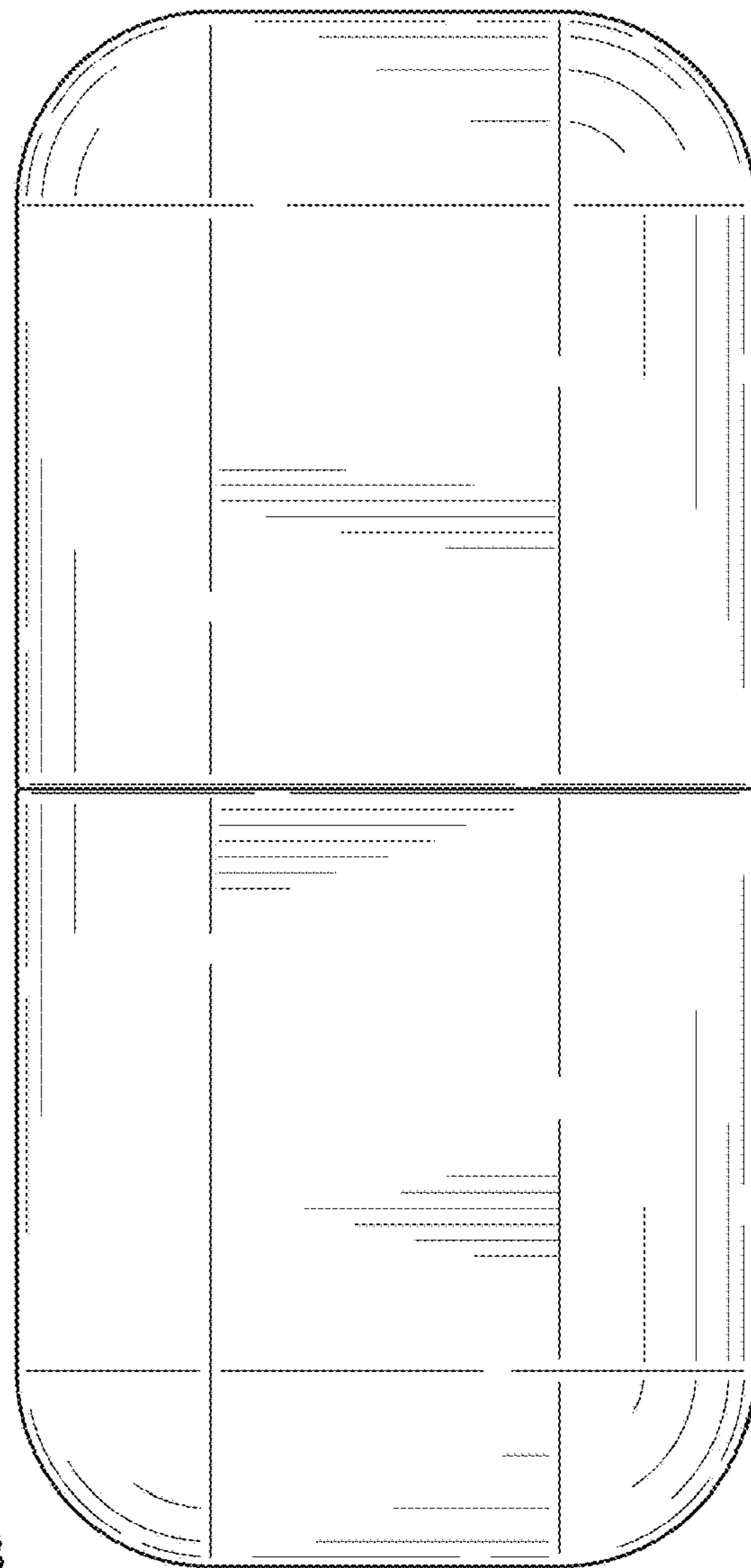

FIG. 3

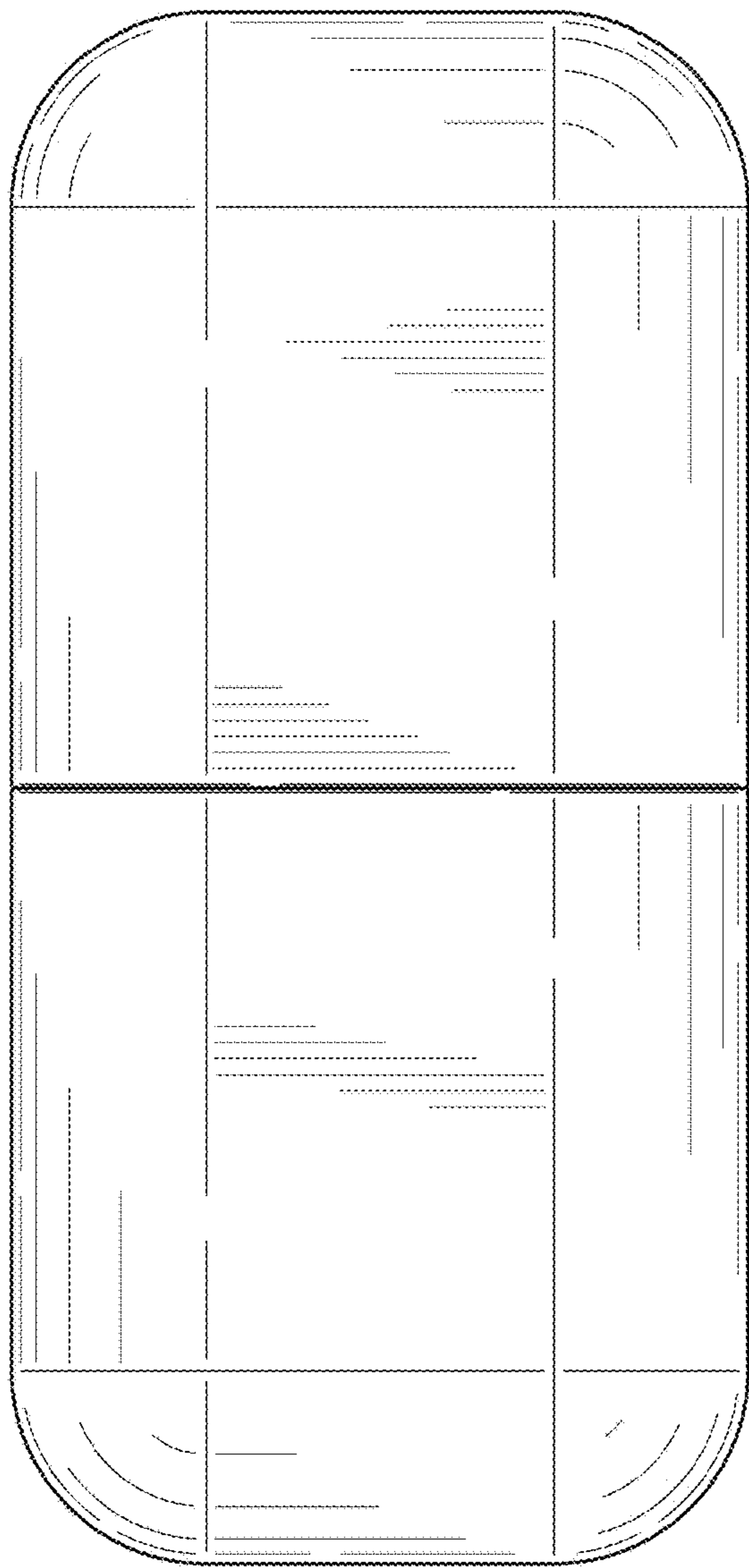

FIG. 4

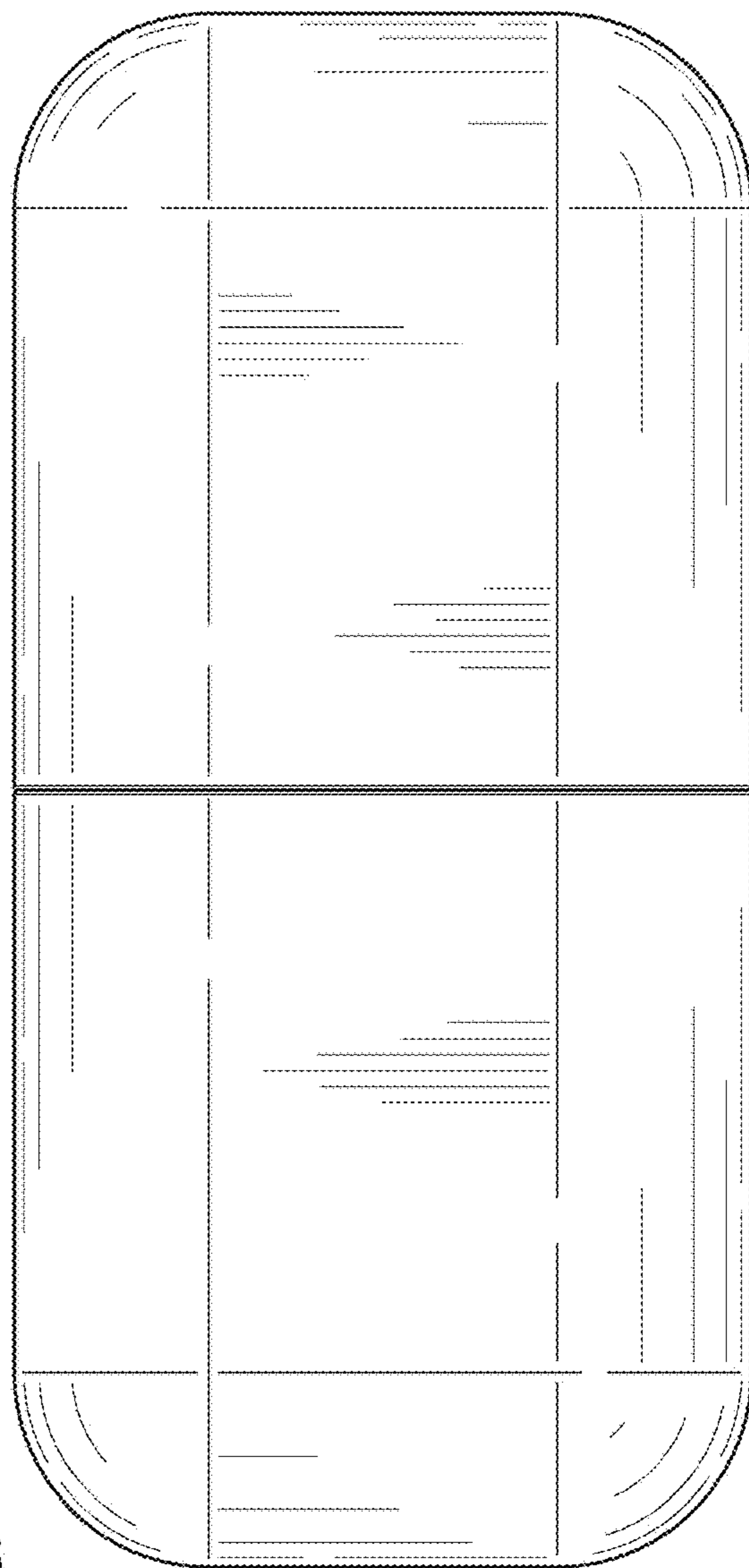

FIG. 5

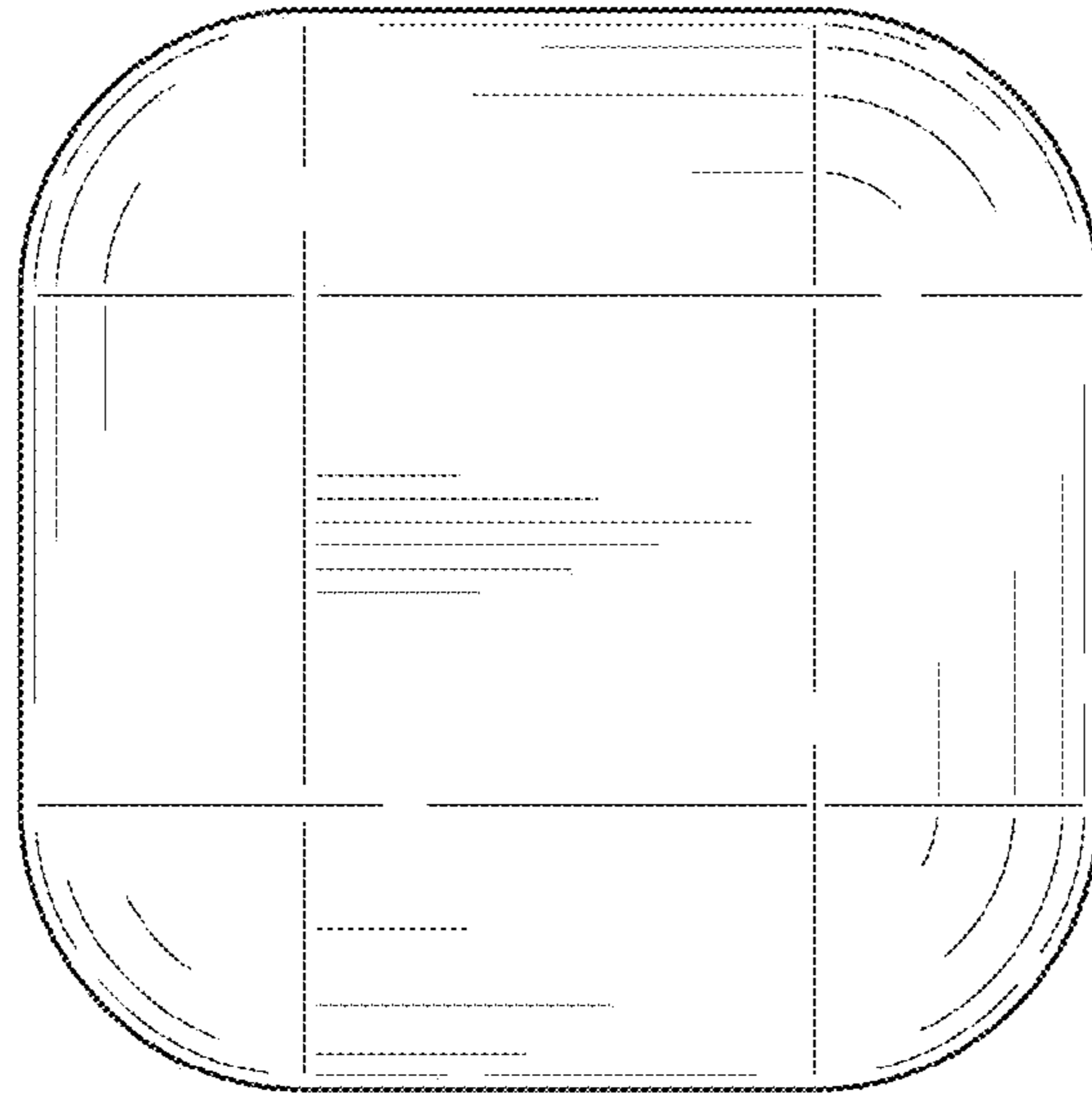

FIG. 6

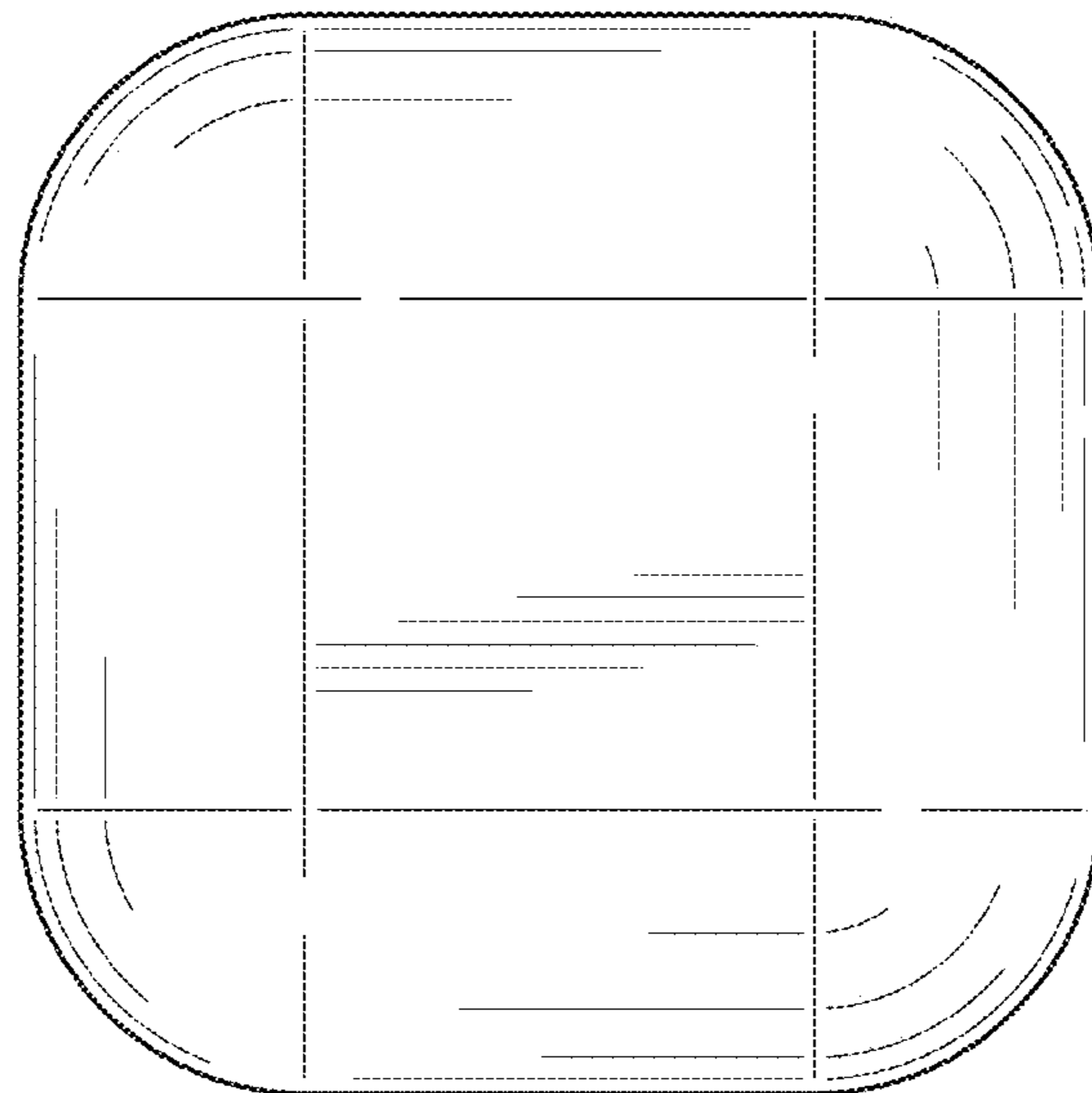

FIG. 7

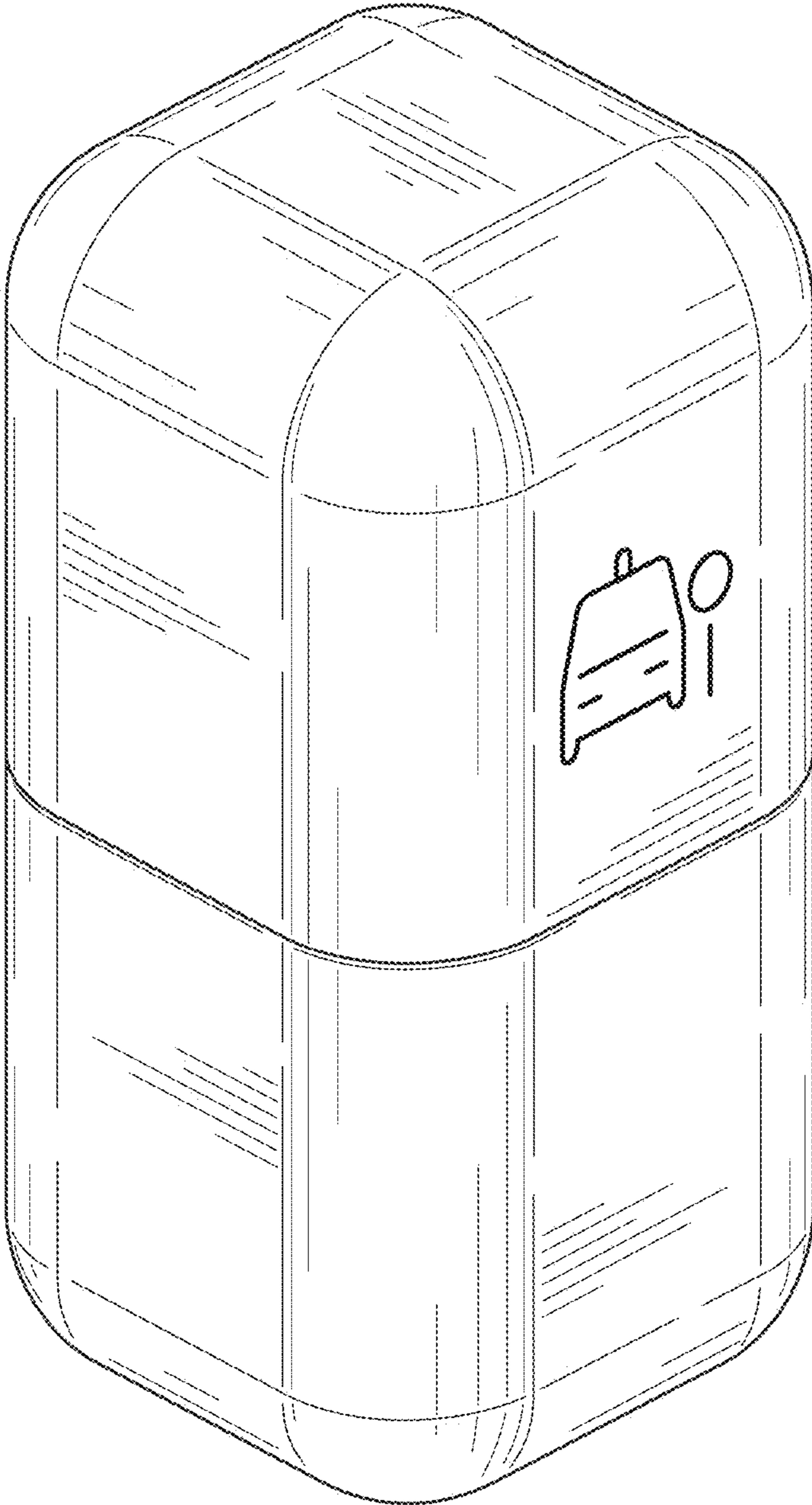

FIG. 8

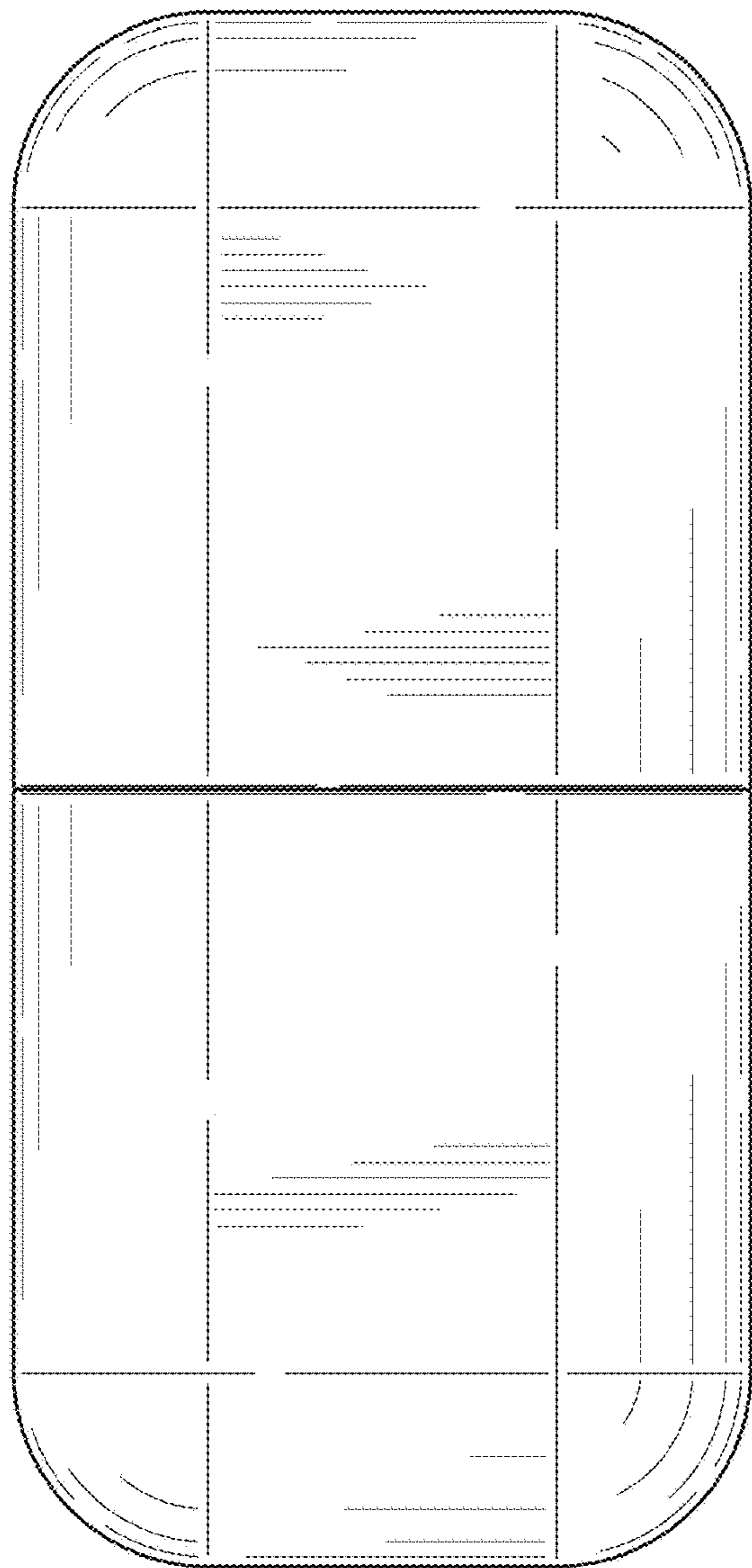

FIG. 9

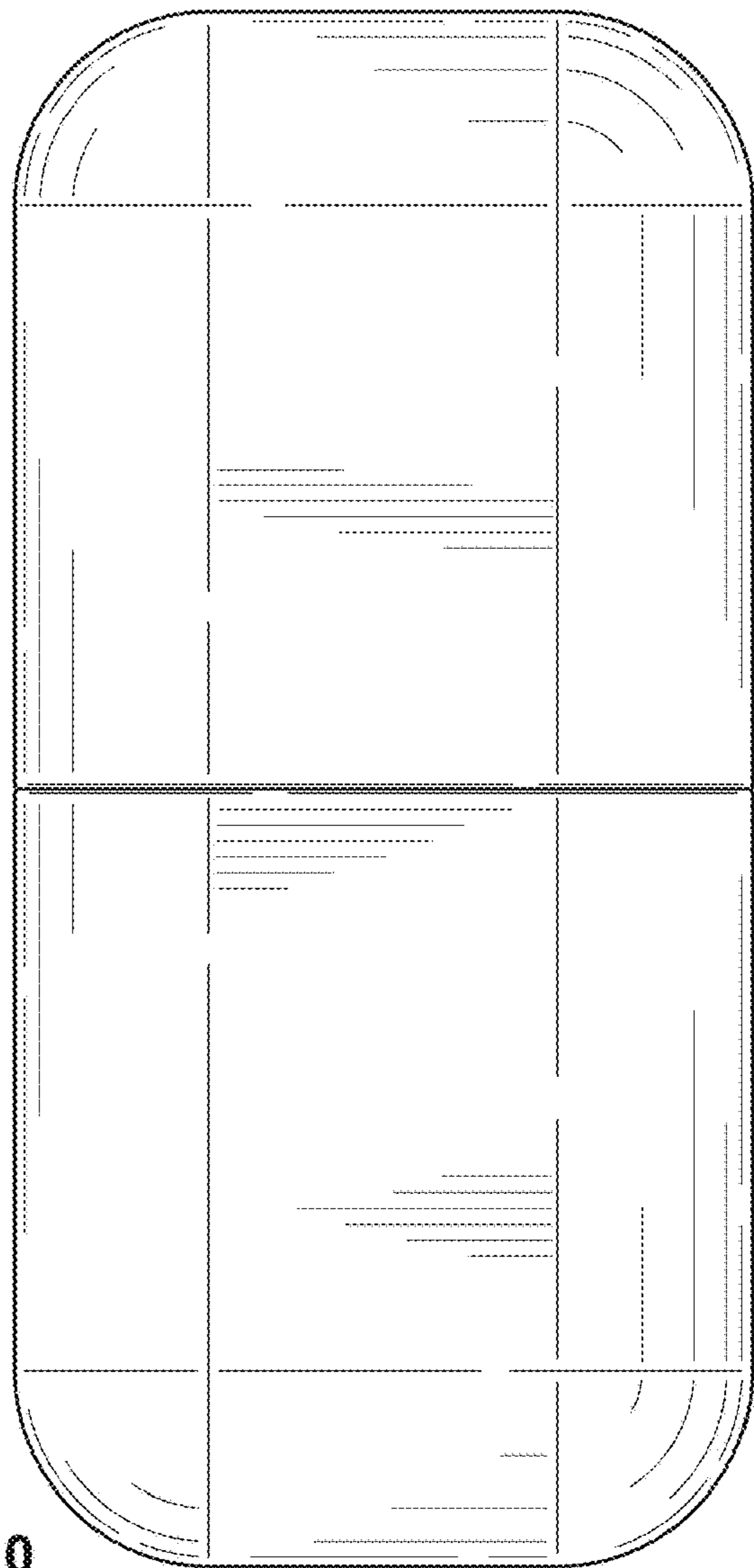

FIG. 10

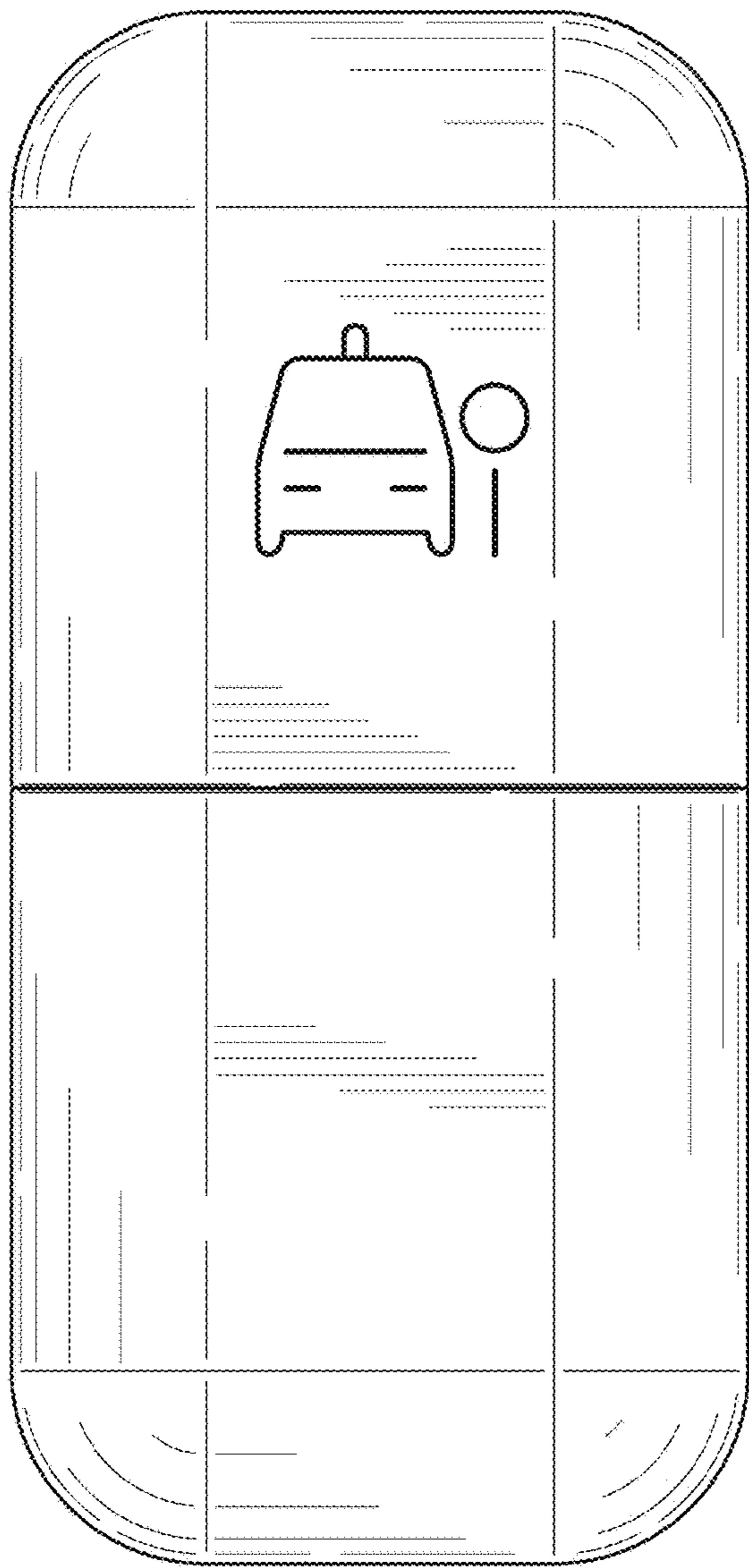

FIG. 11

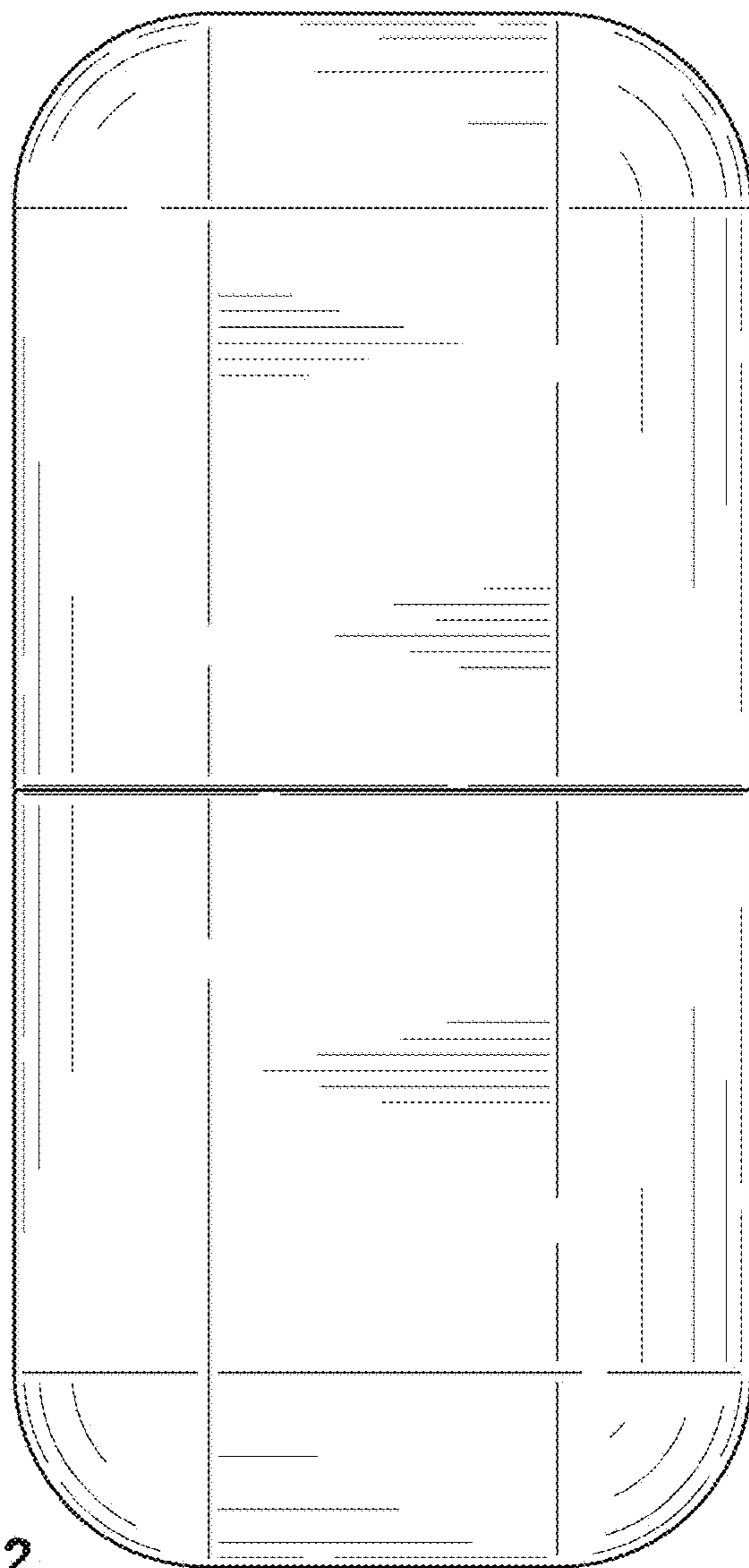

FIG. 12

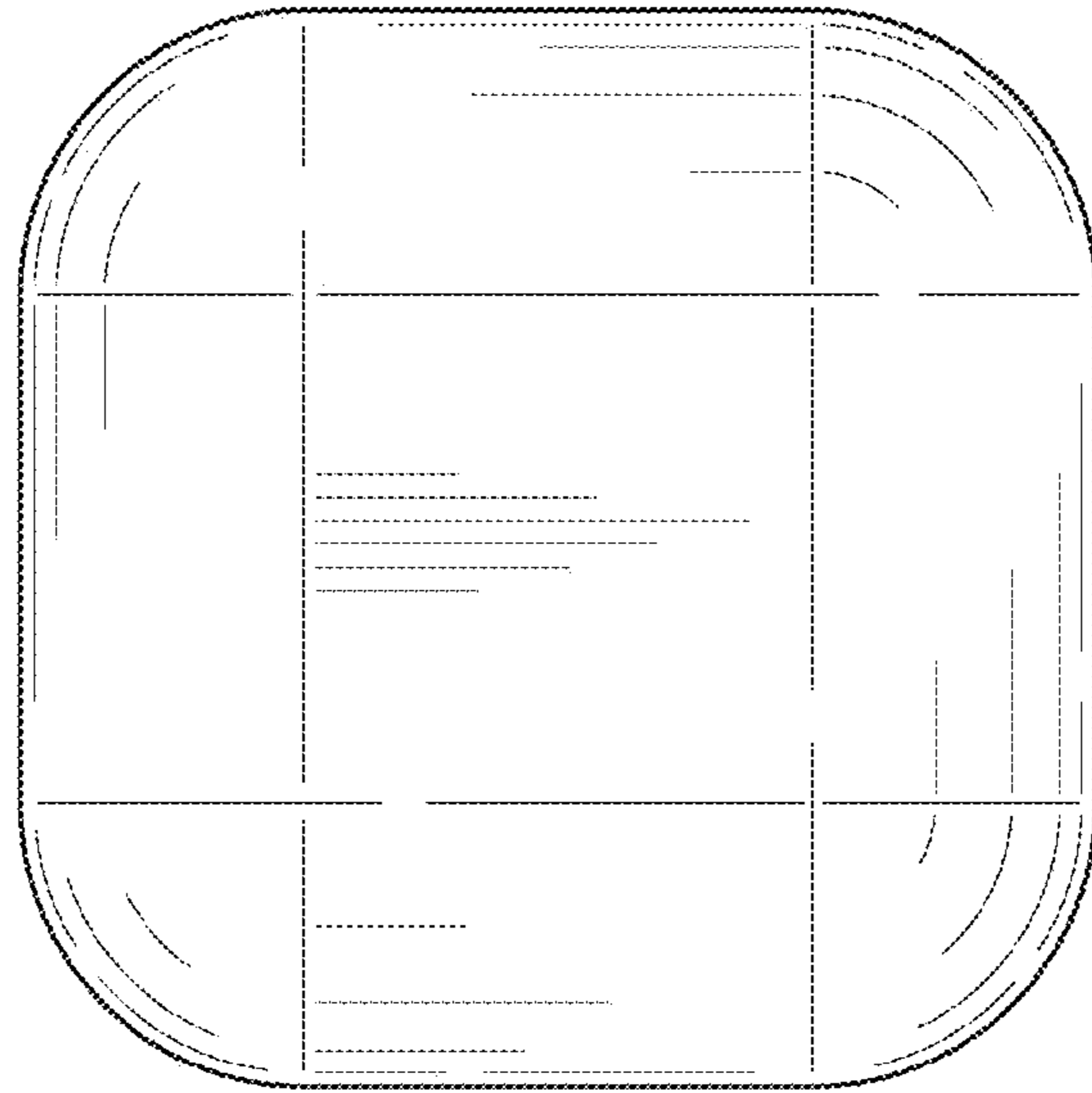

FIG. 13

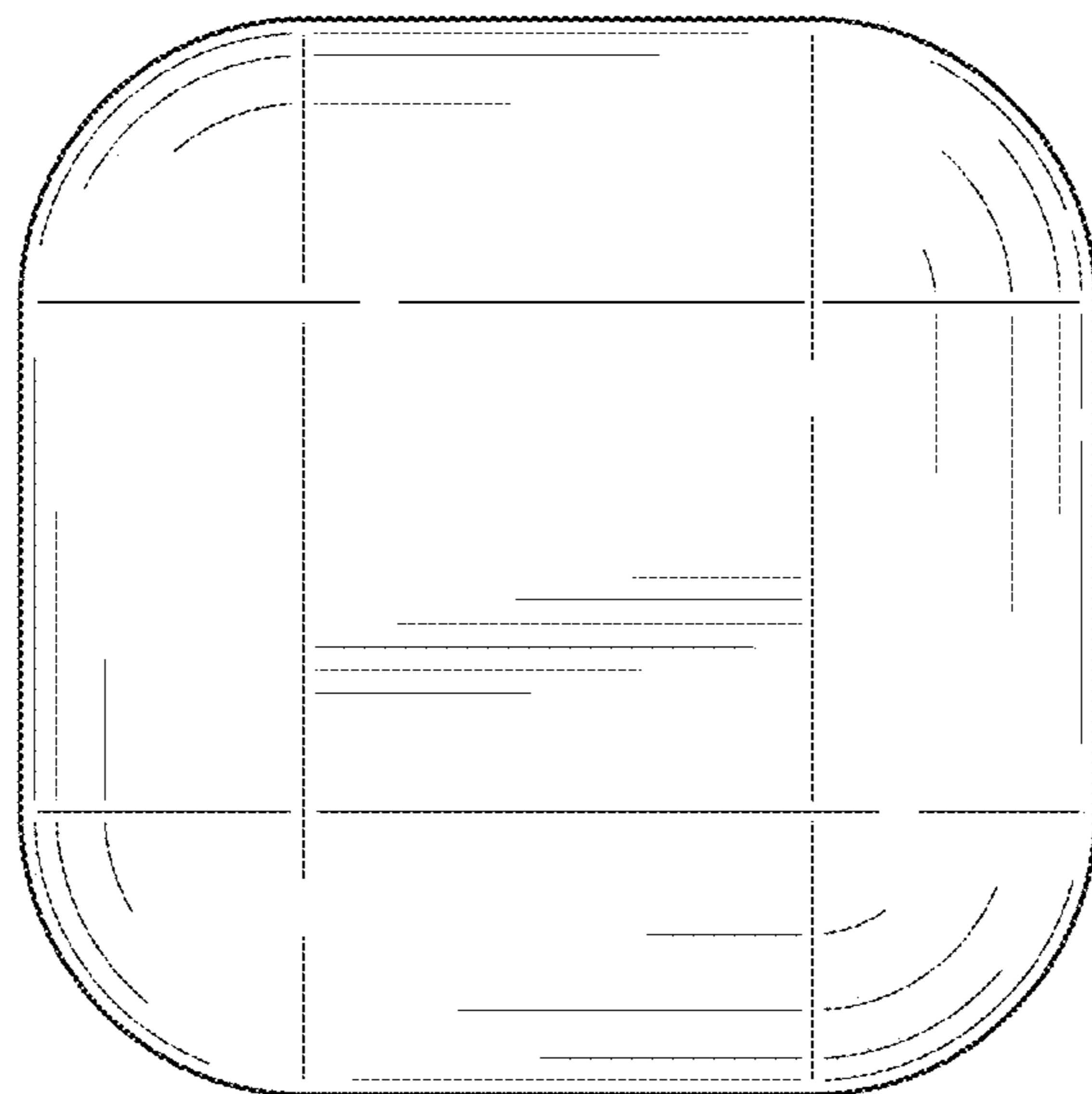

FIG. 14

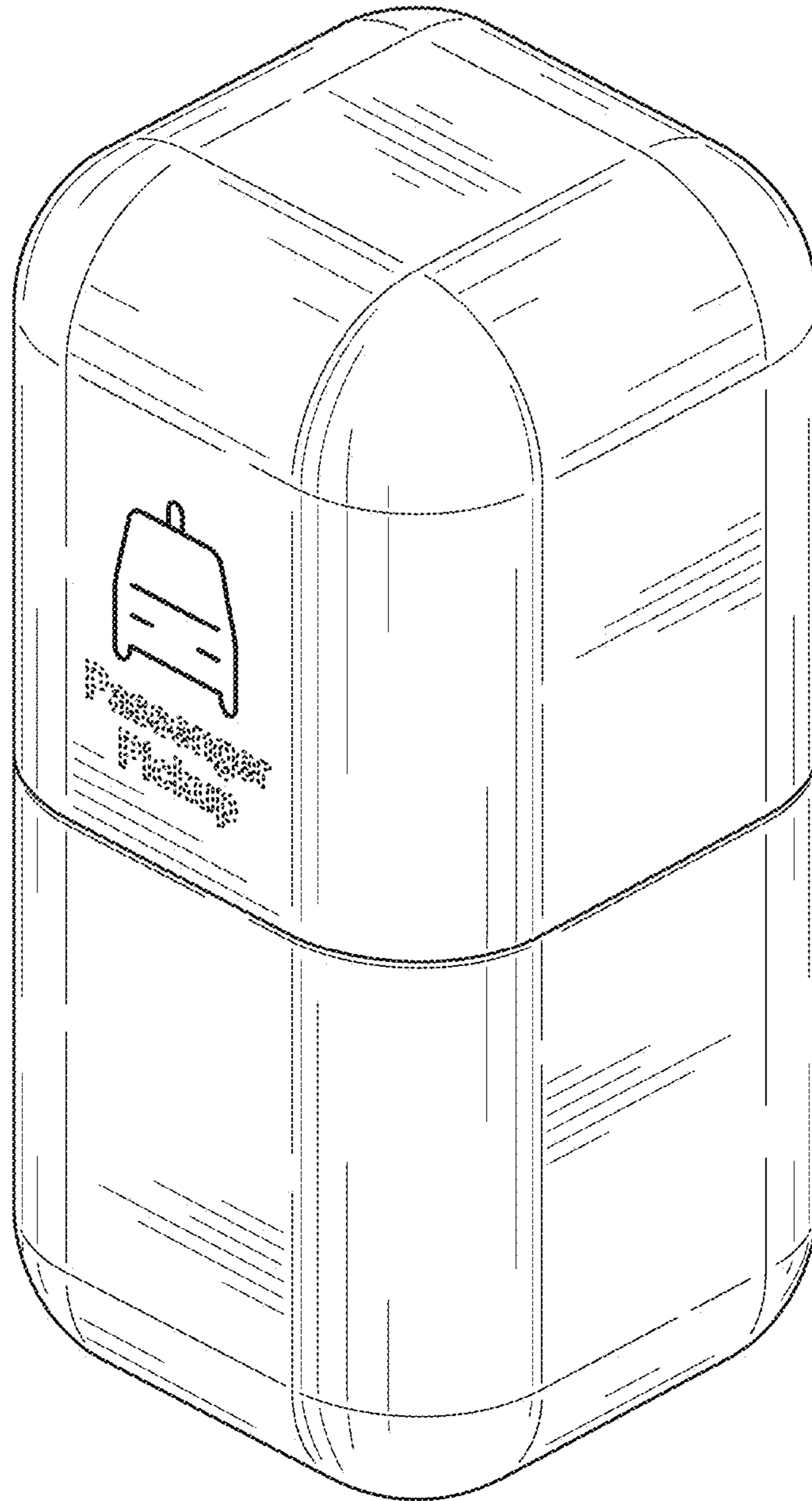

FIG. 15

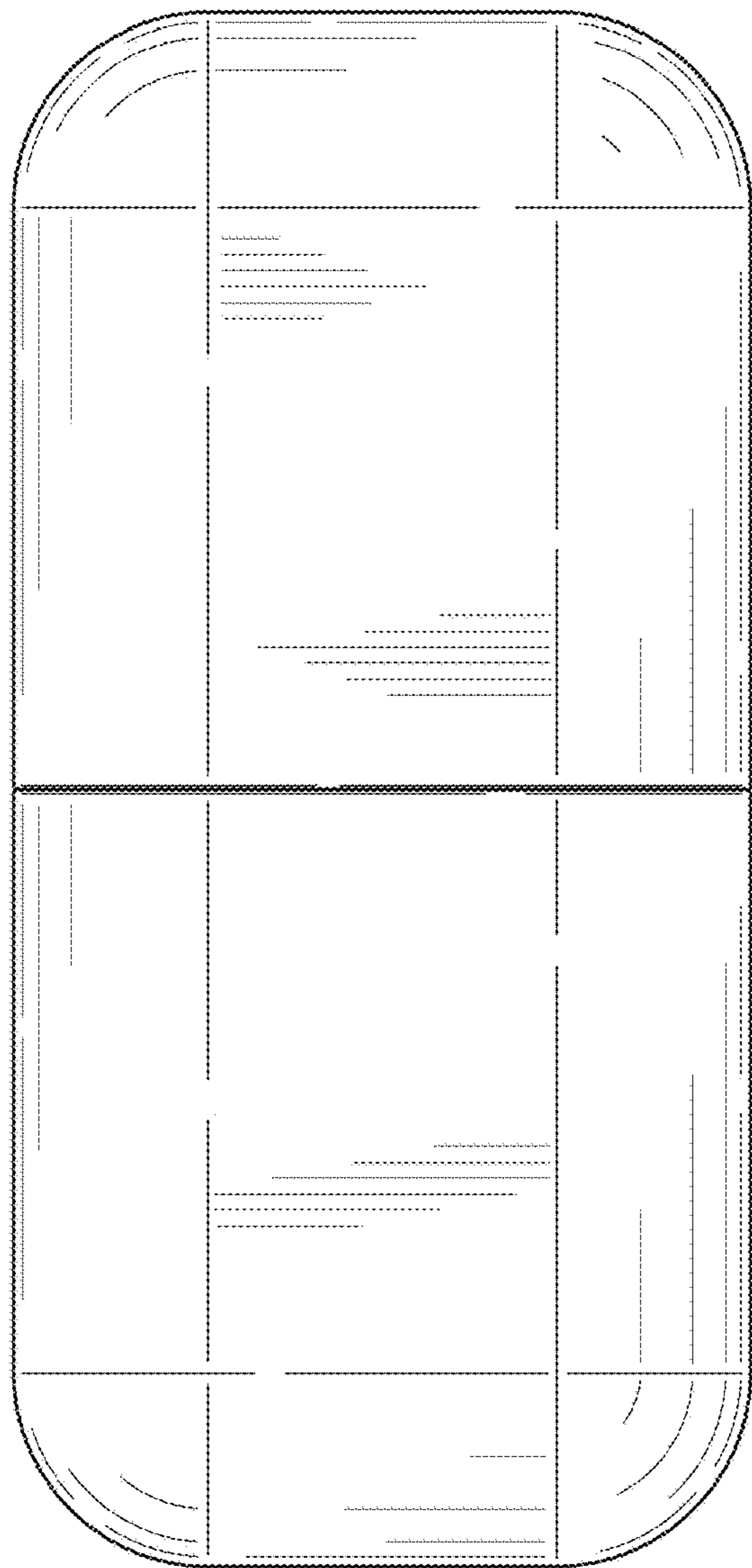

FIG. 16

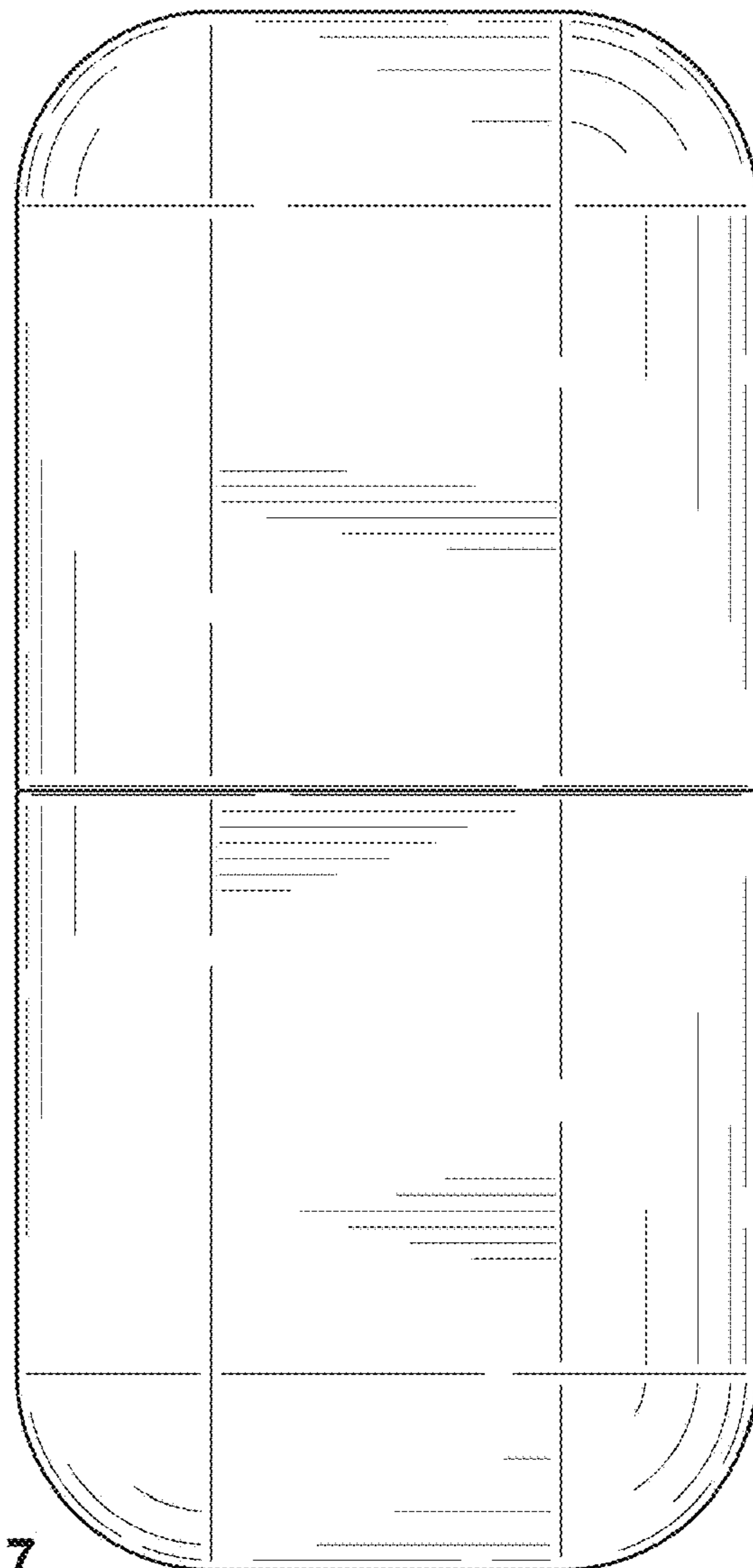

FIG. 17

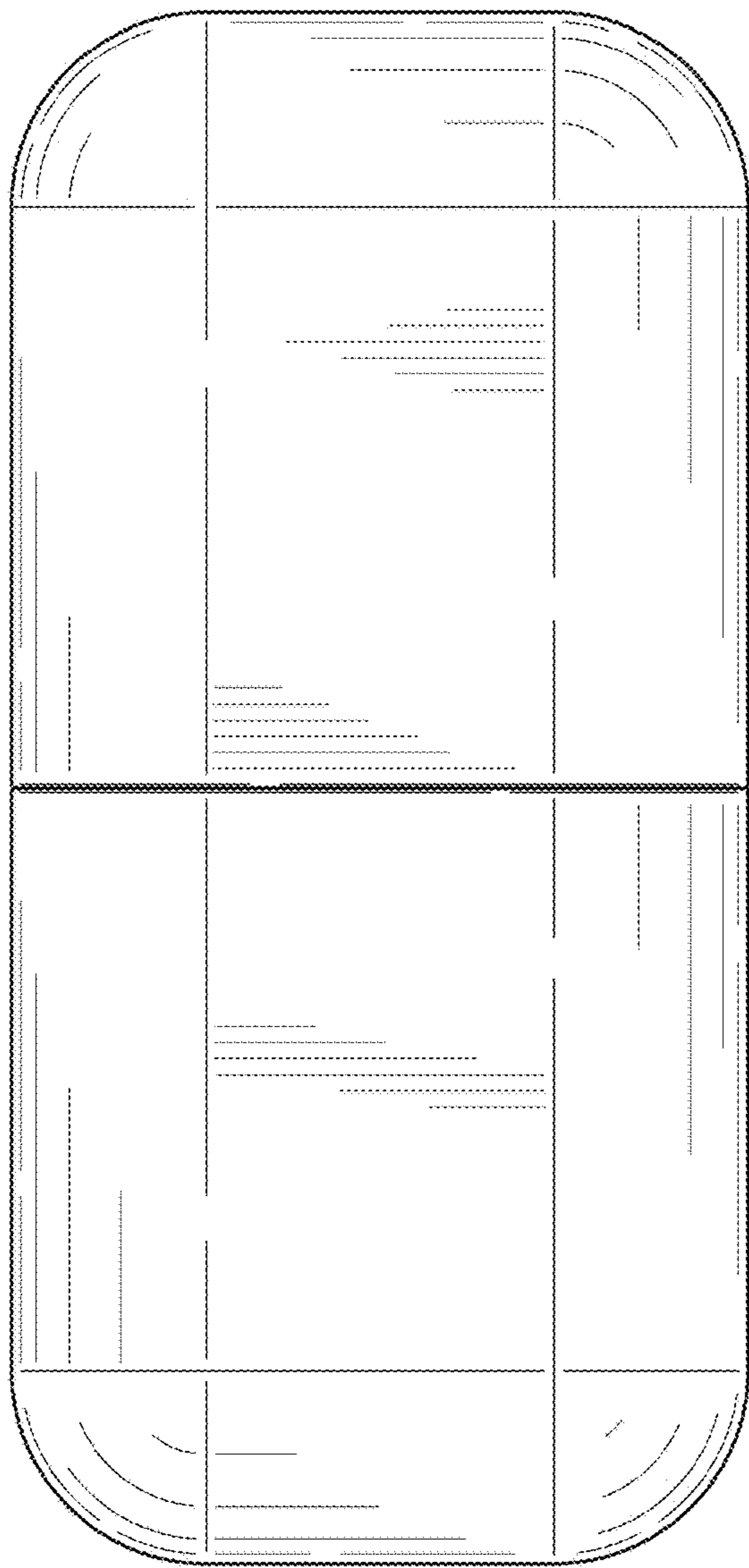

FIG. 18

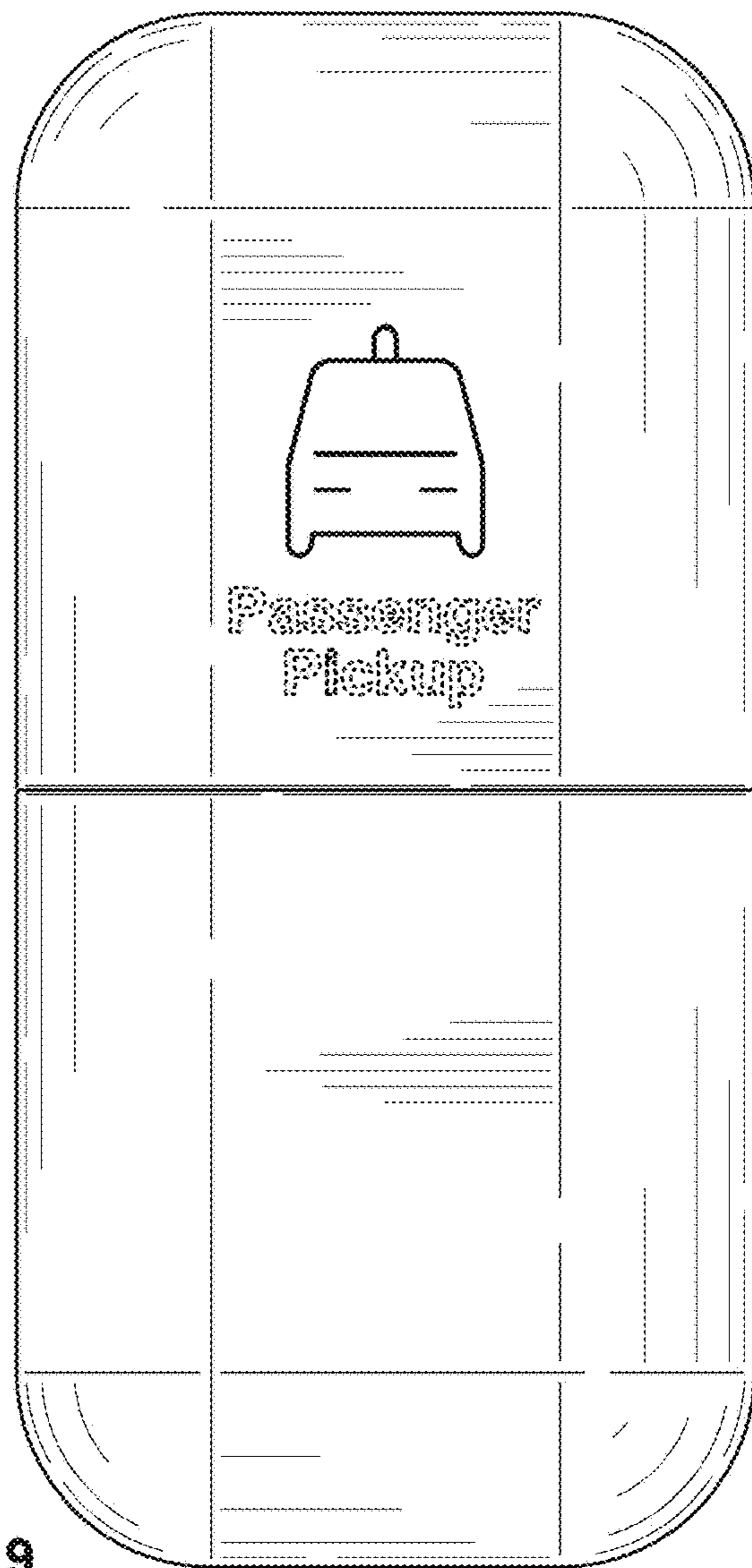

FIG. 19

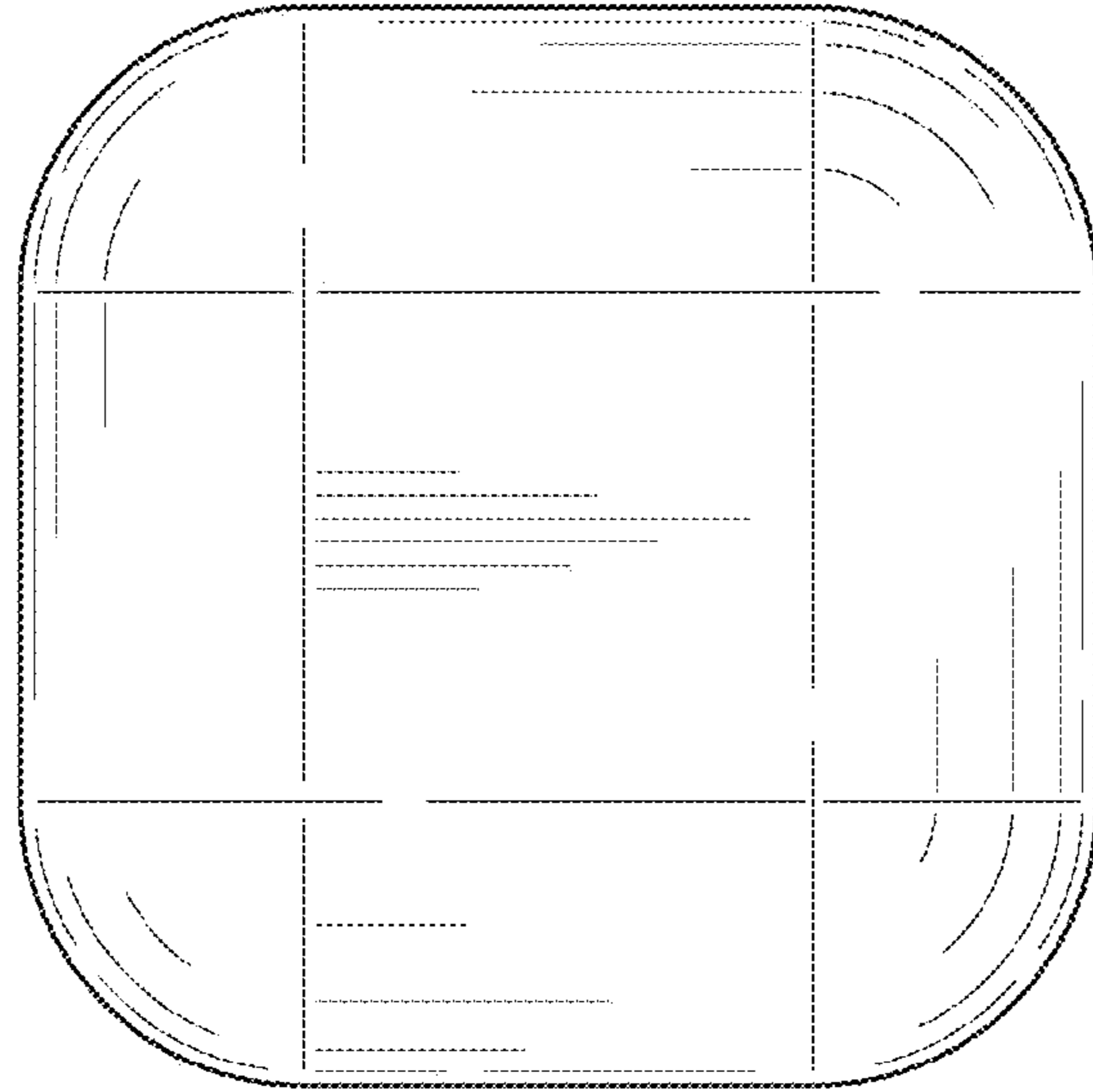

FIG. 20

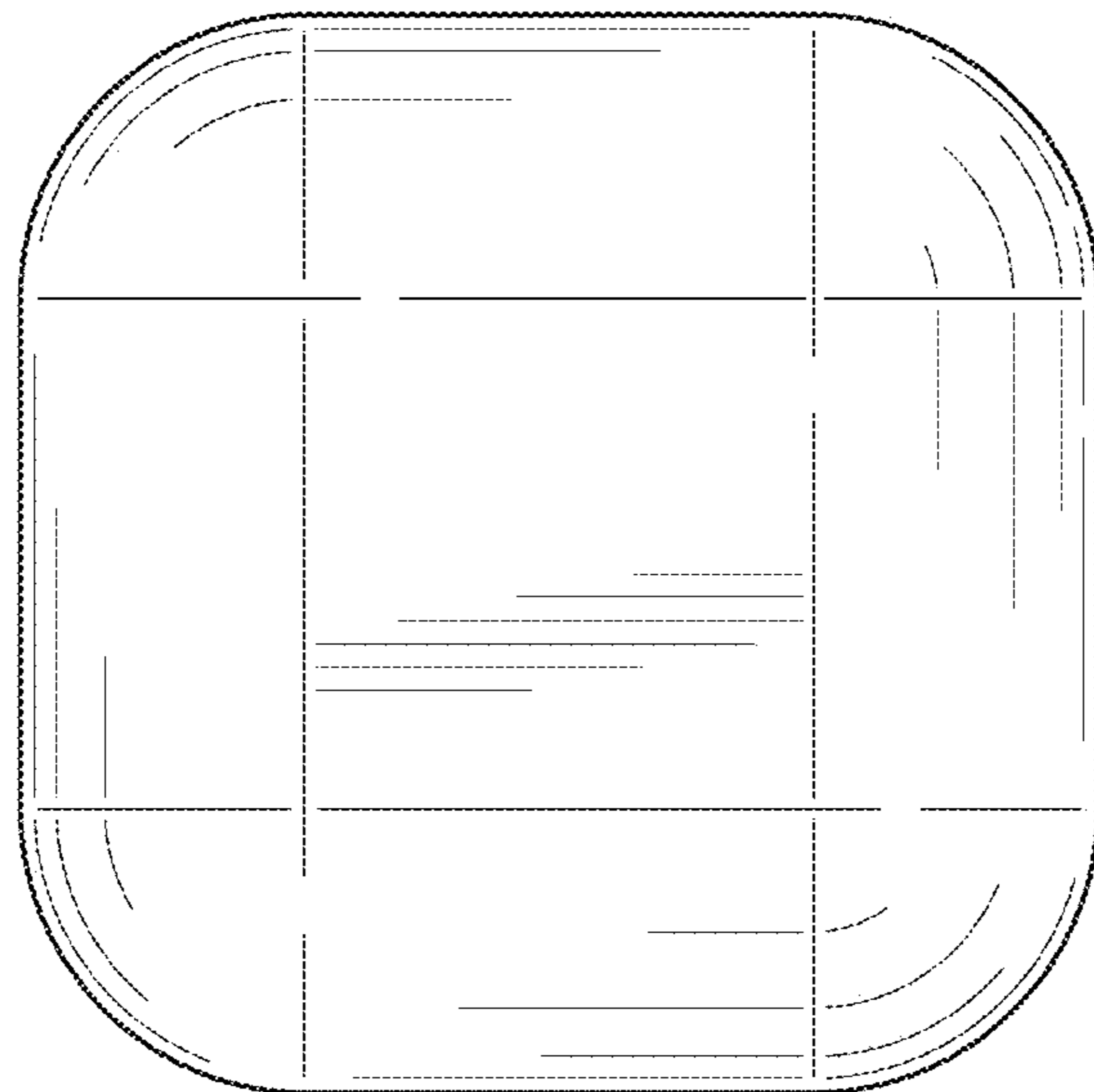

FIG. 21

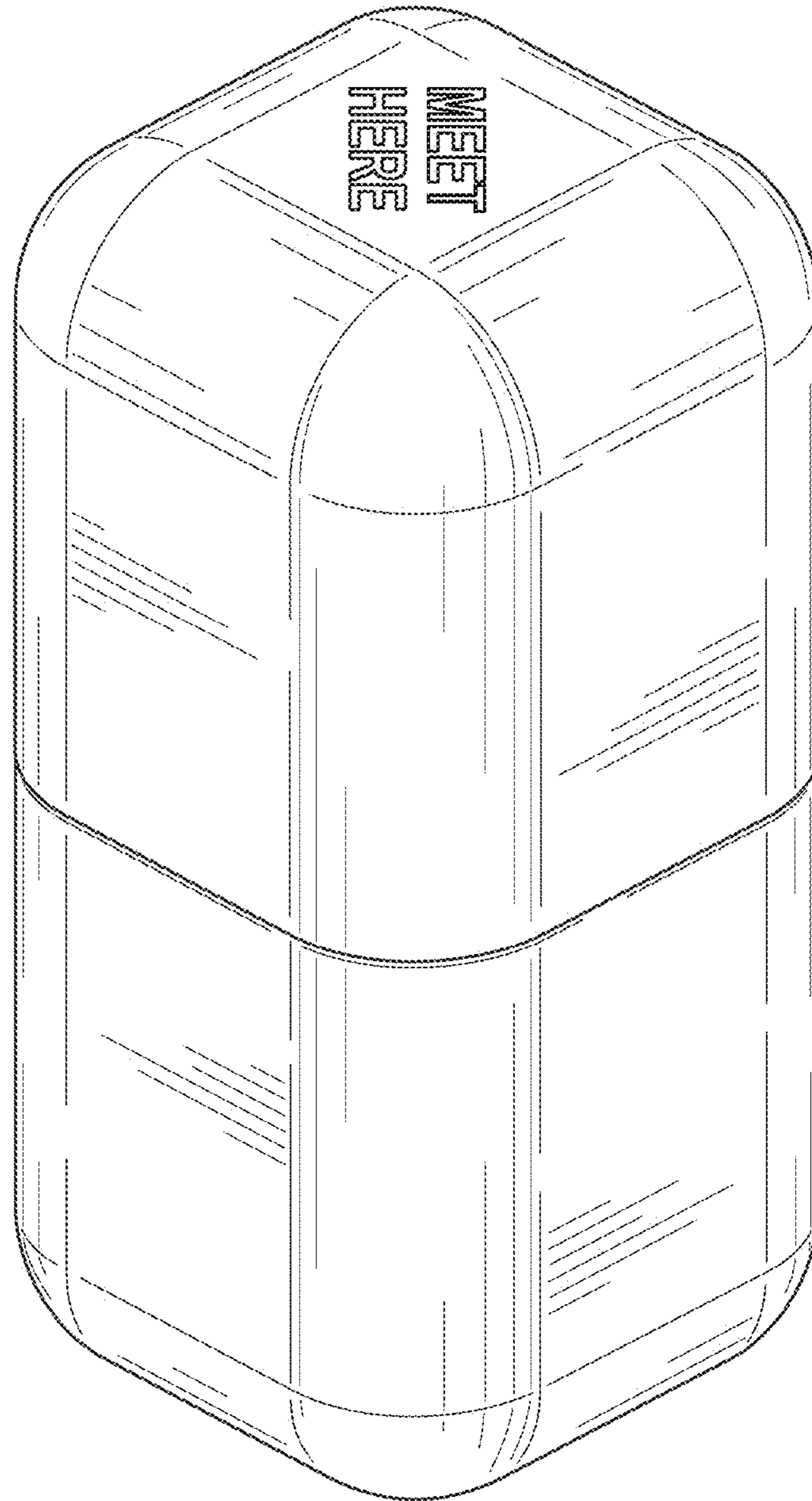

FIG. 22

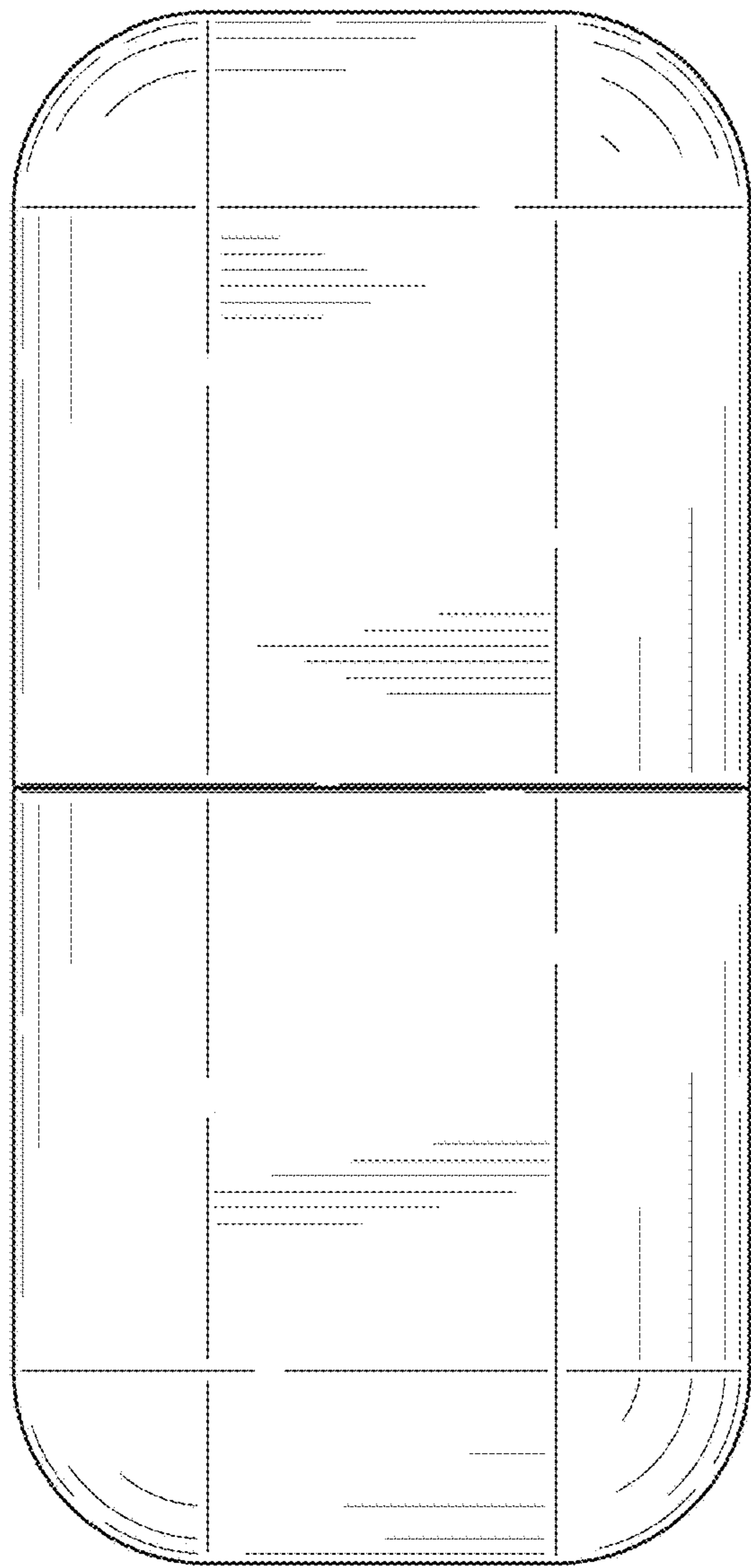

FIG. 23

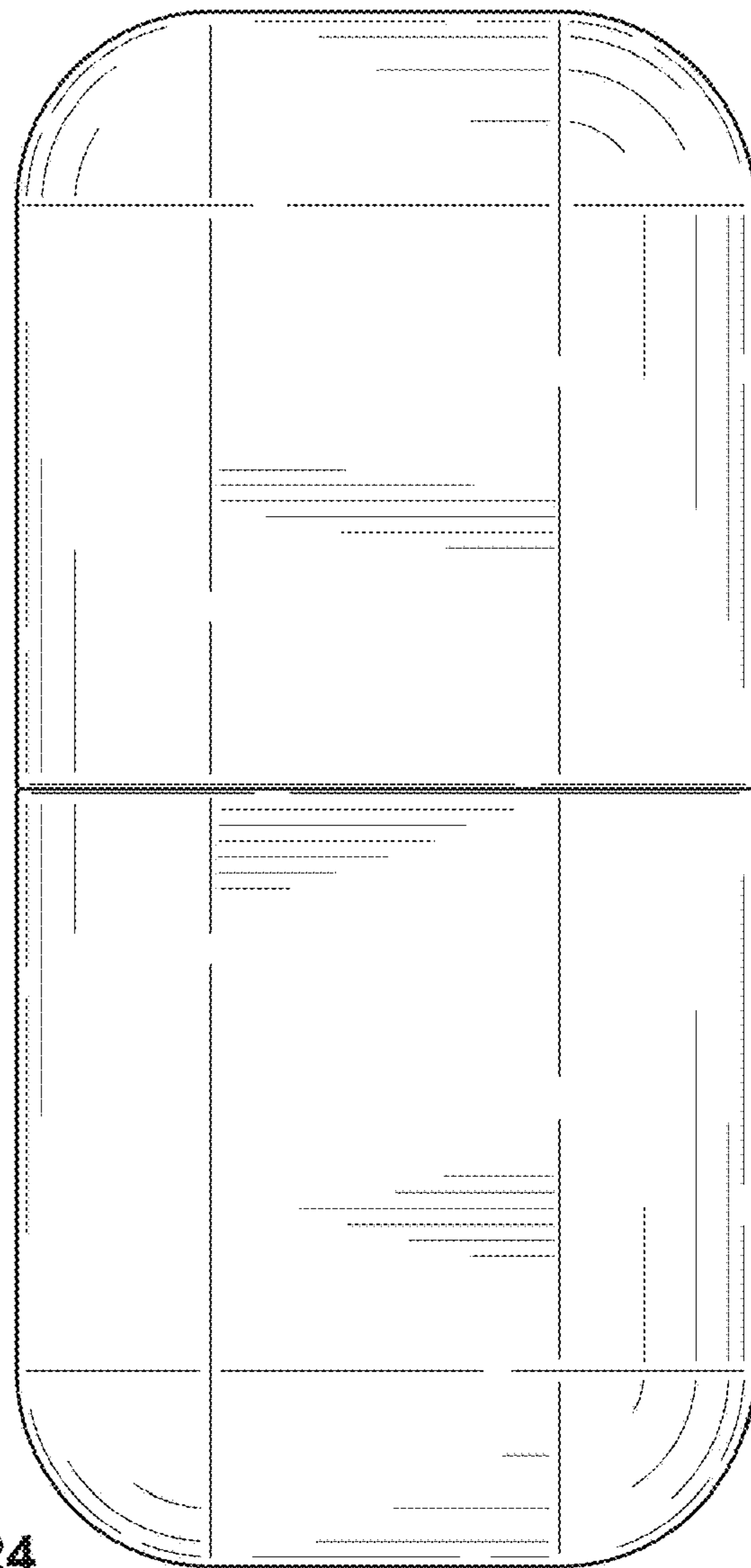

FIG. 24

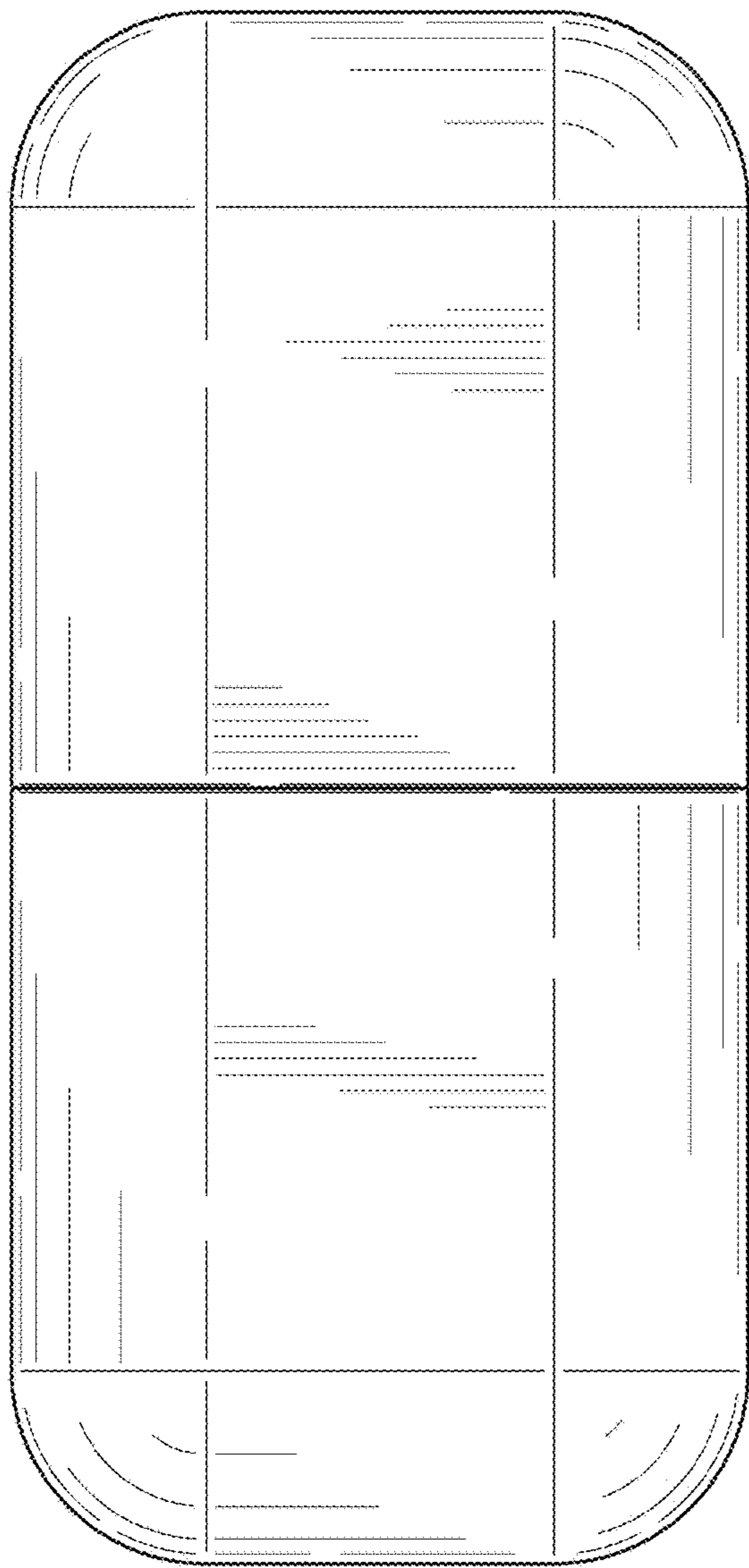

FIG. 25

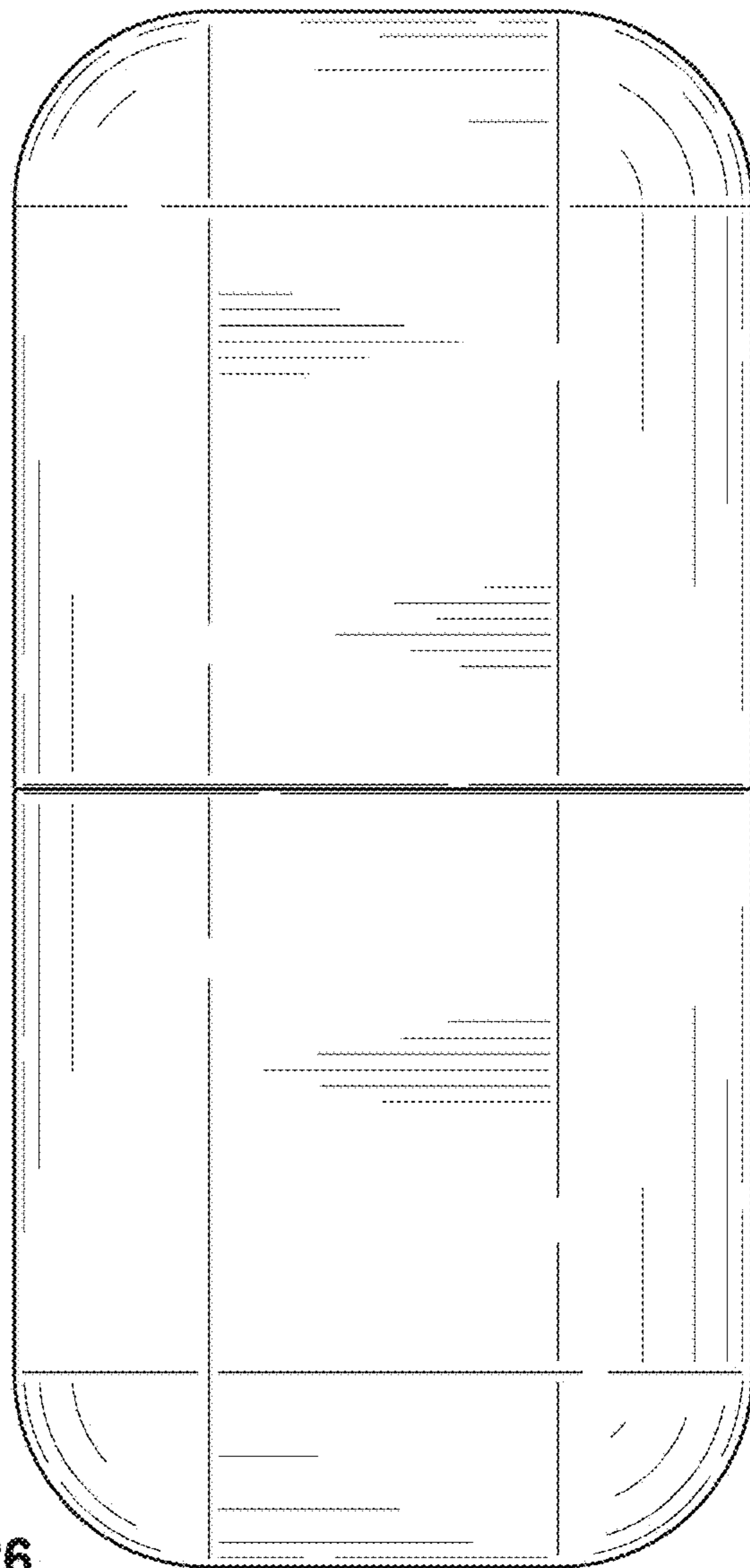

FIG. 26



FIG. 27

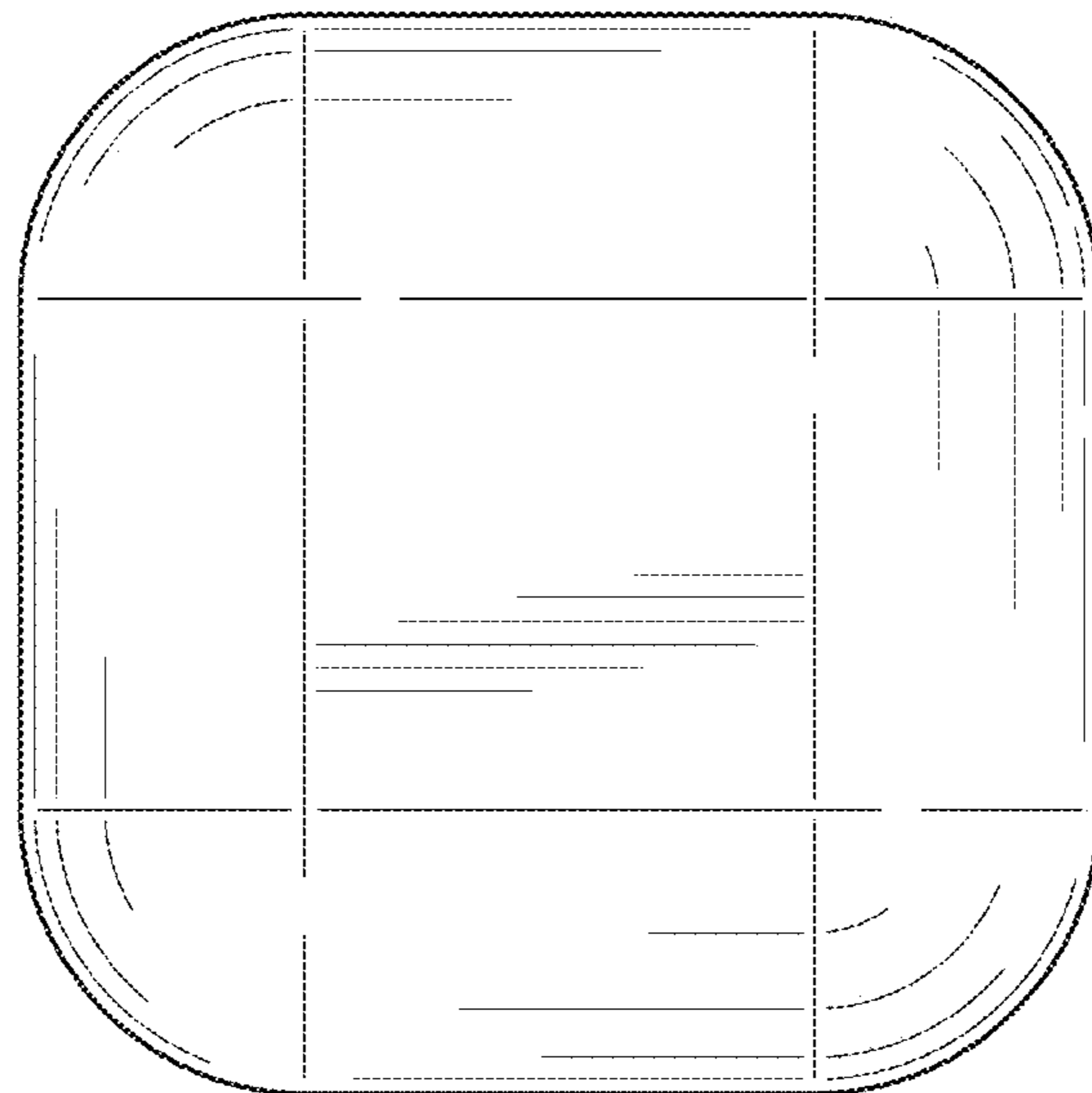

FIG. 28

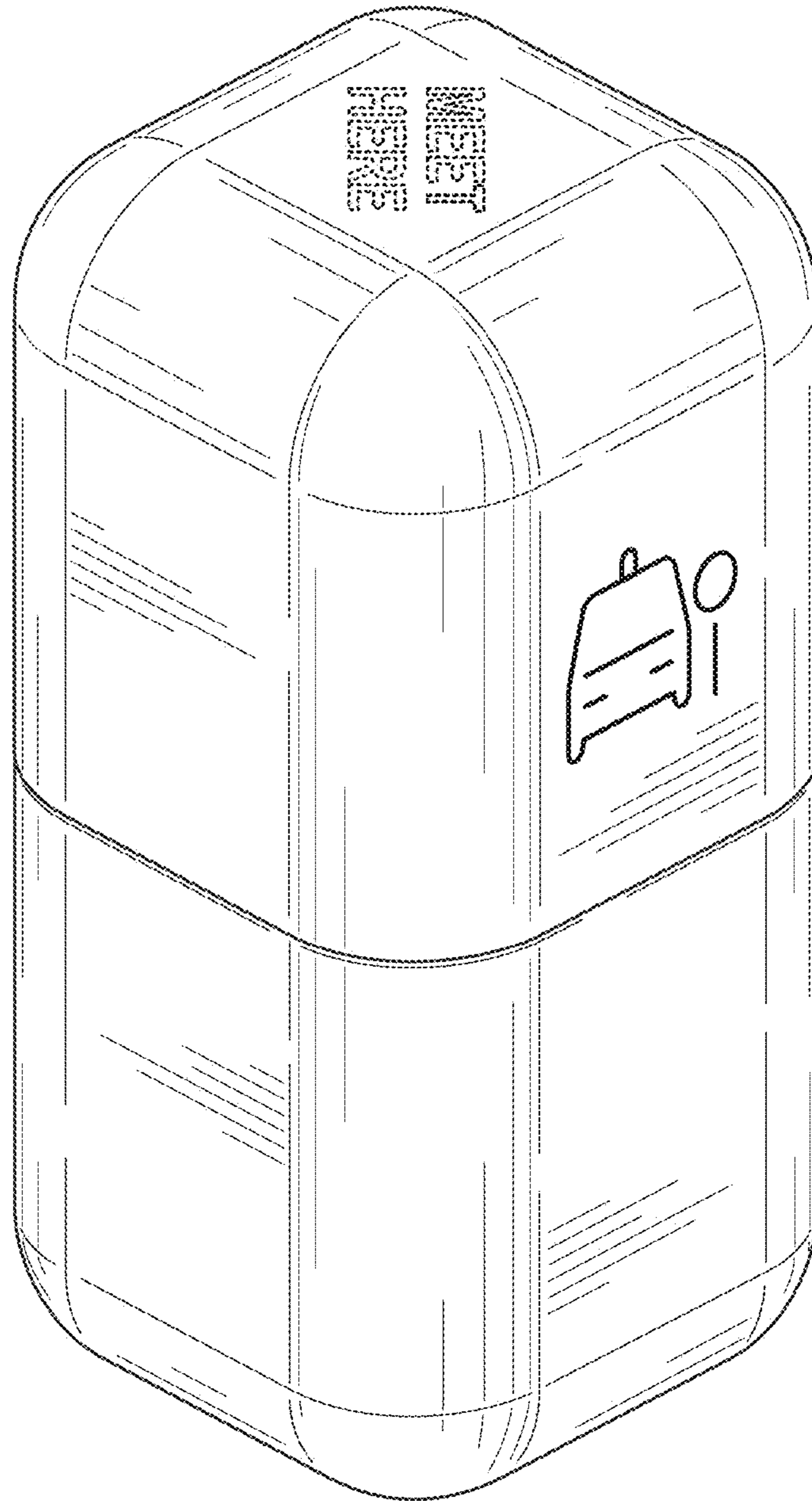

FIG. 29

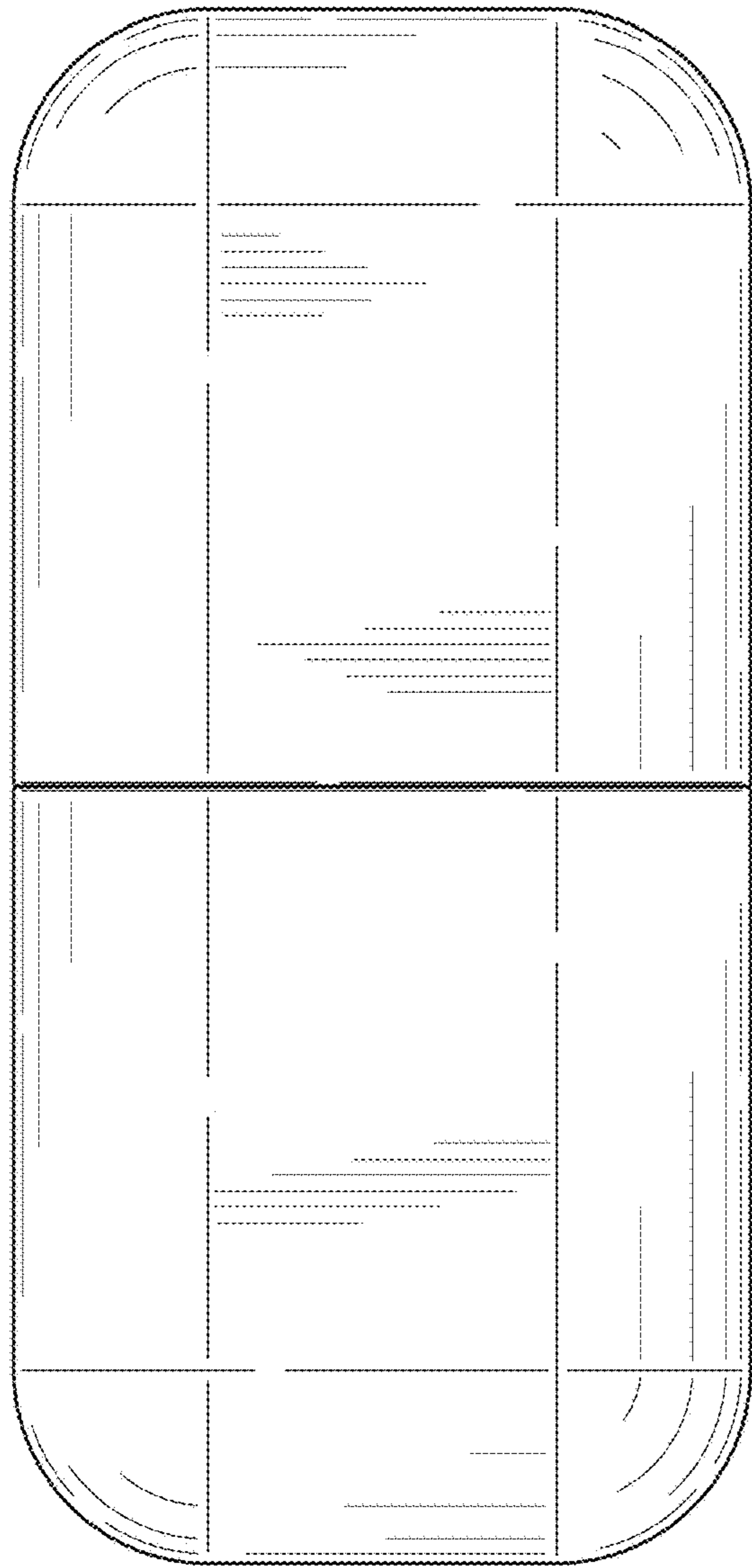

FIG. 30

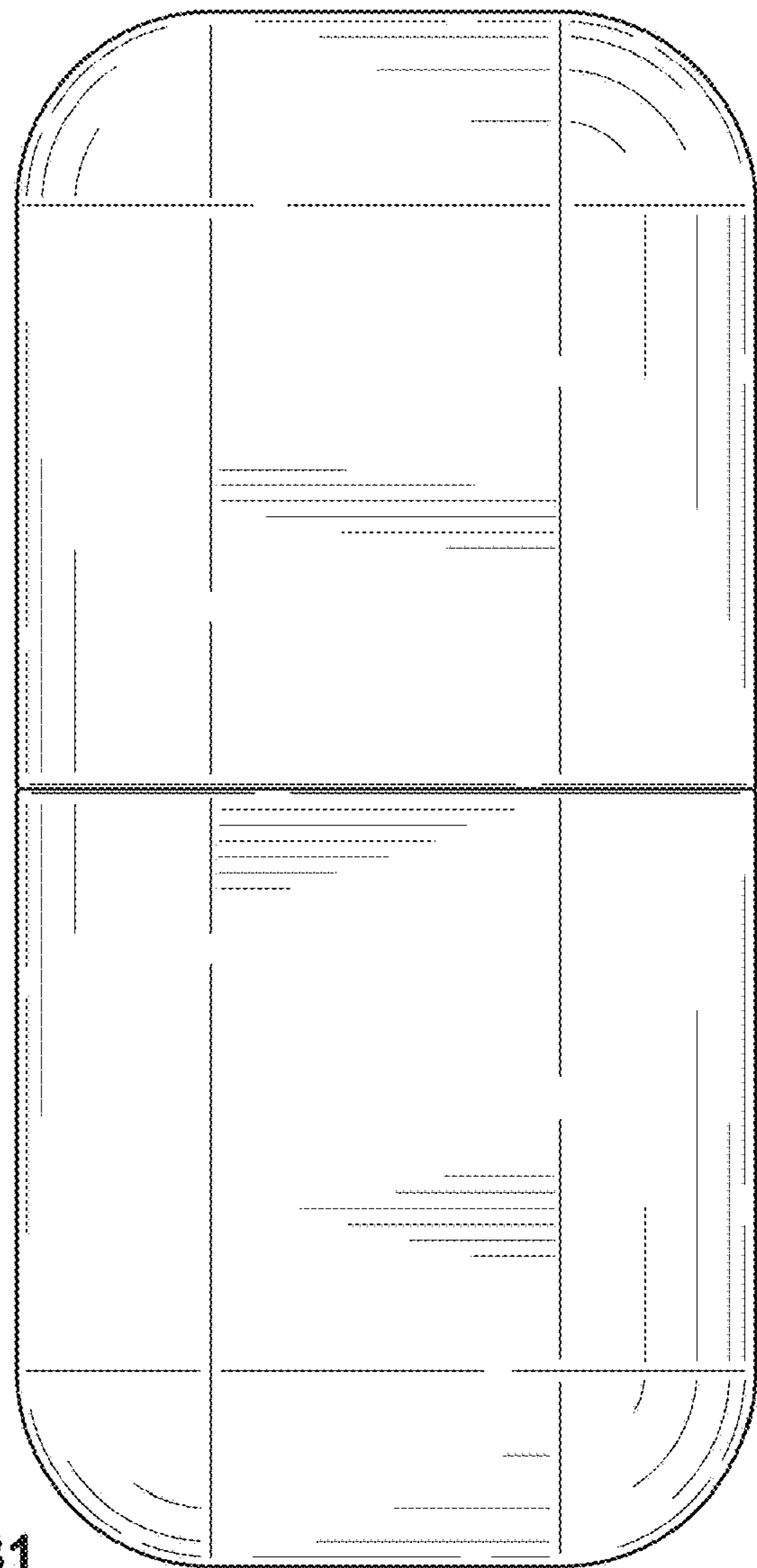

FIG. 31

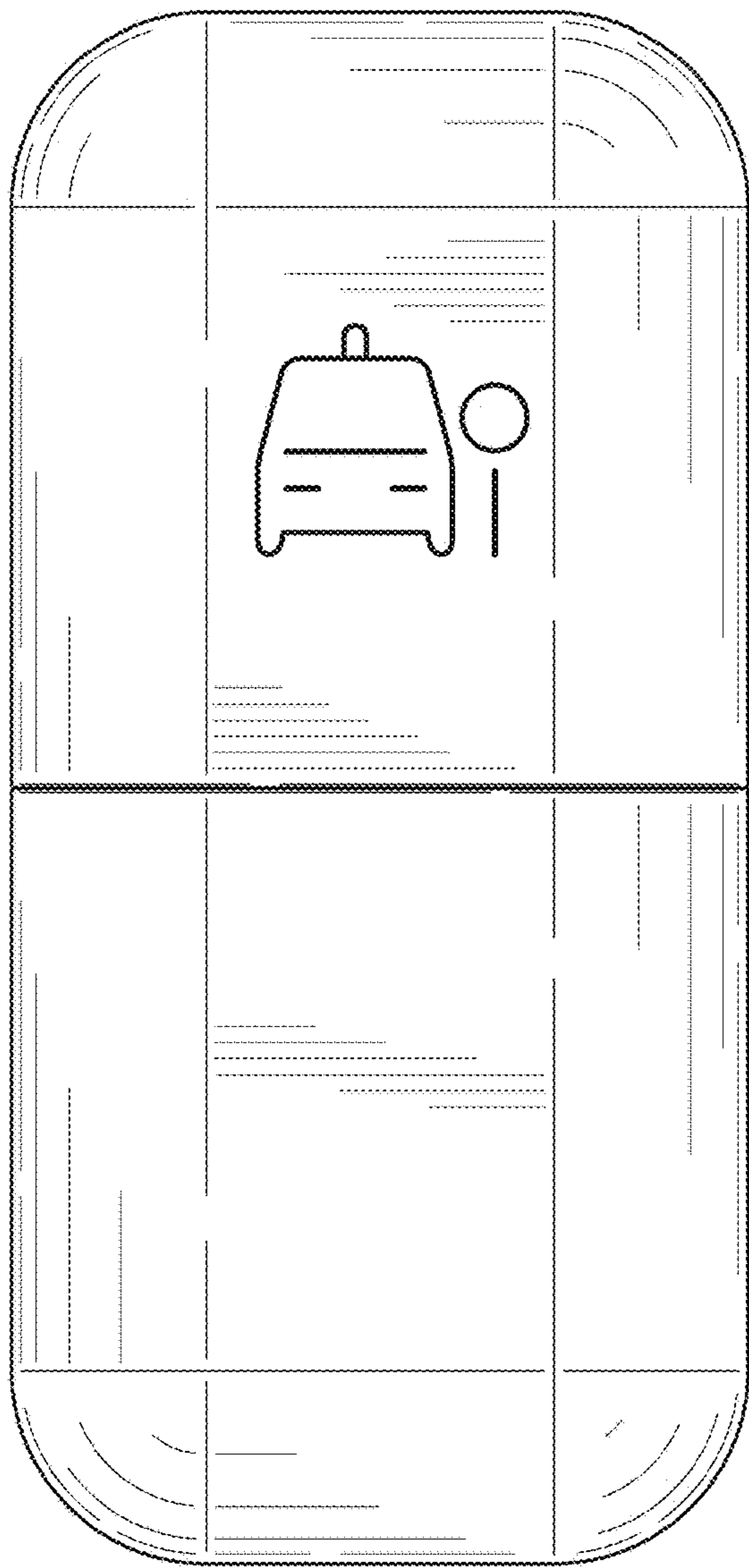

FIG. 32

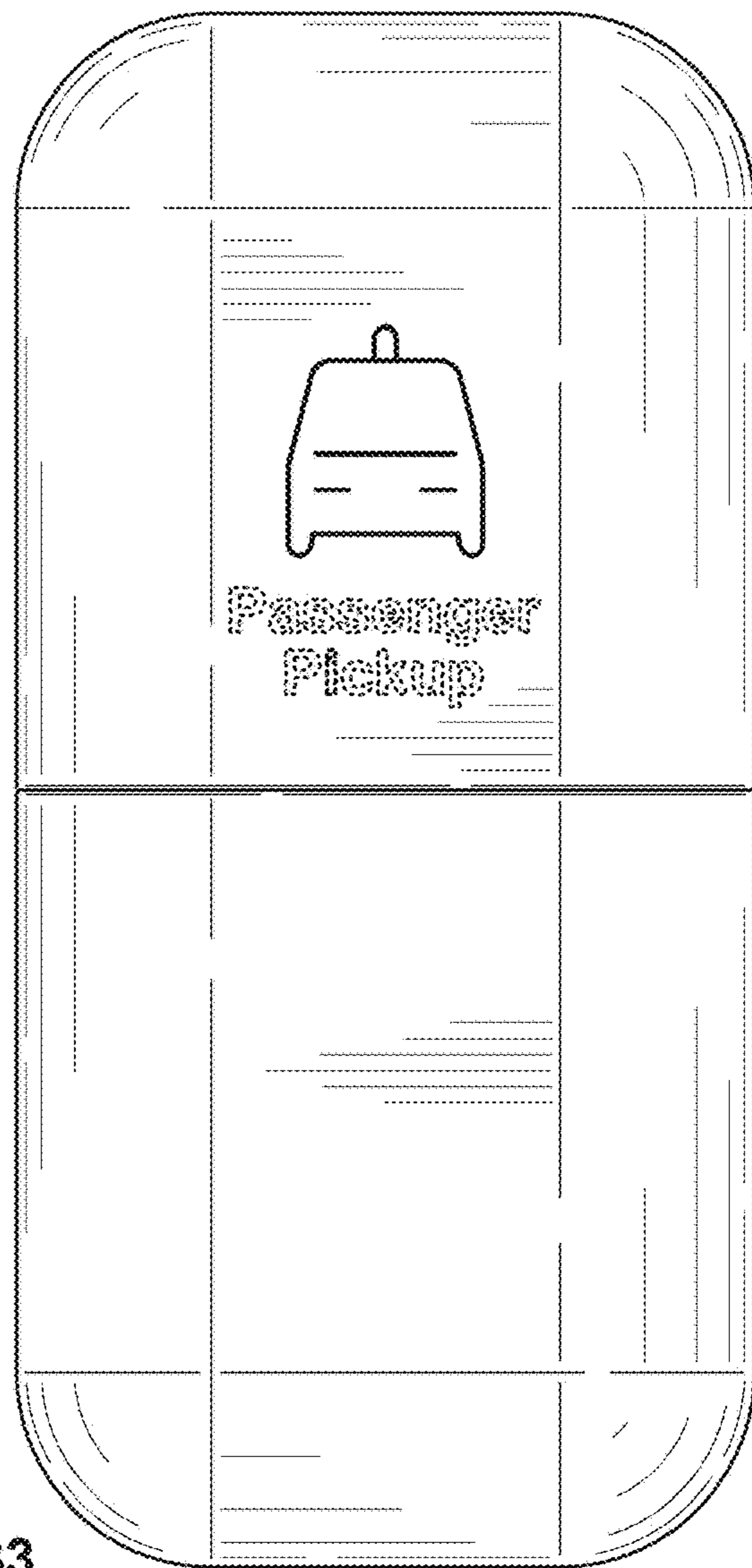

FIG. 33

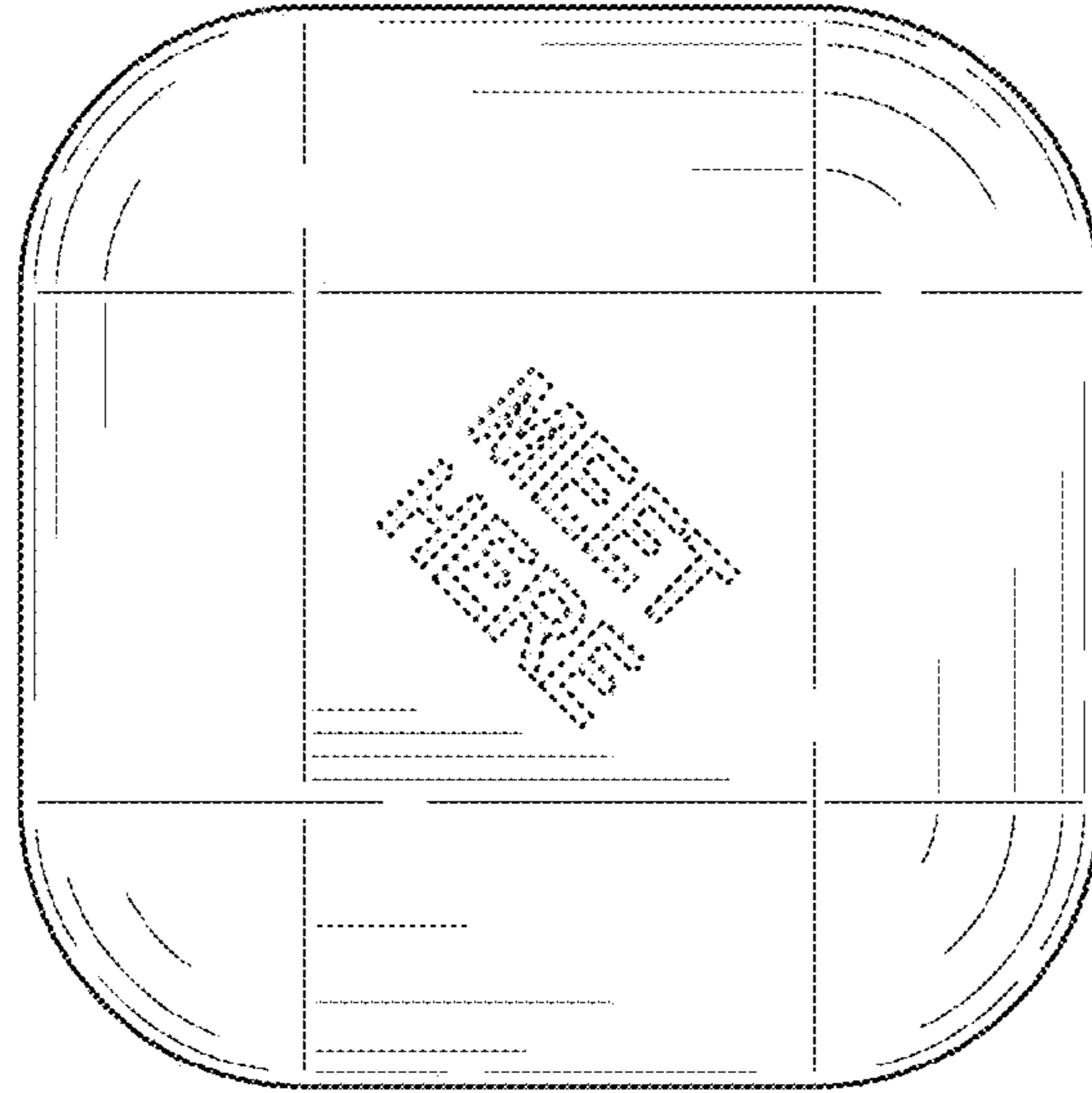

FIG. 34

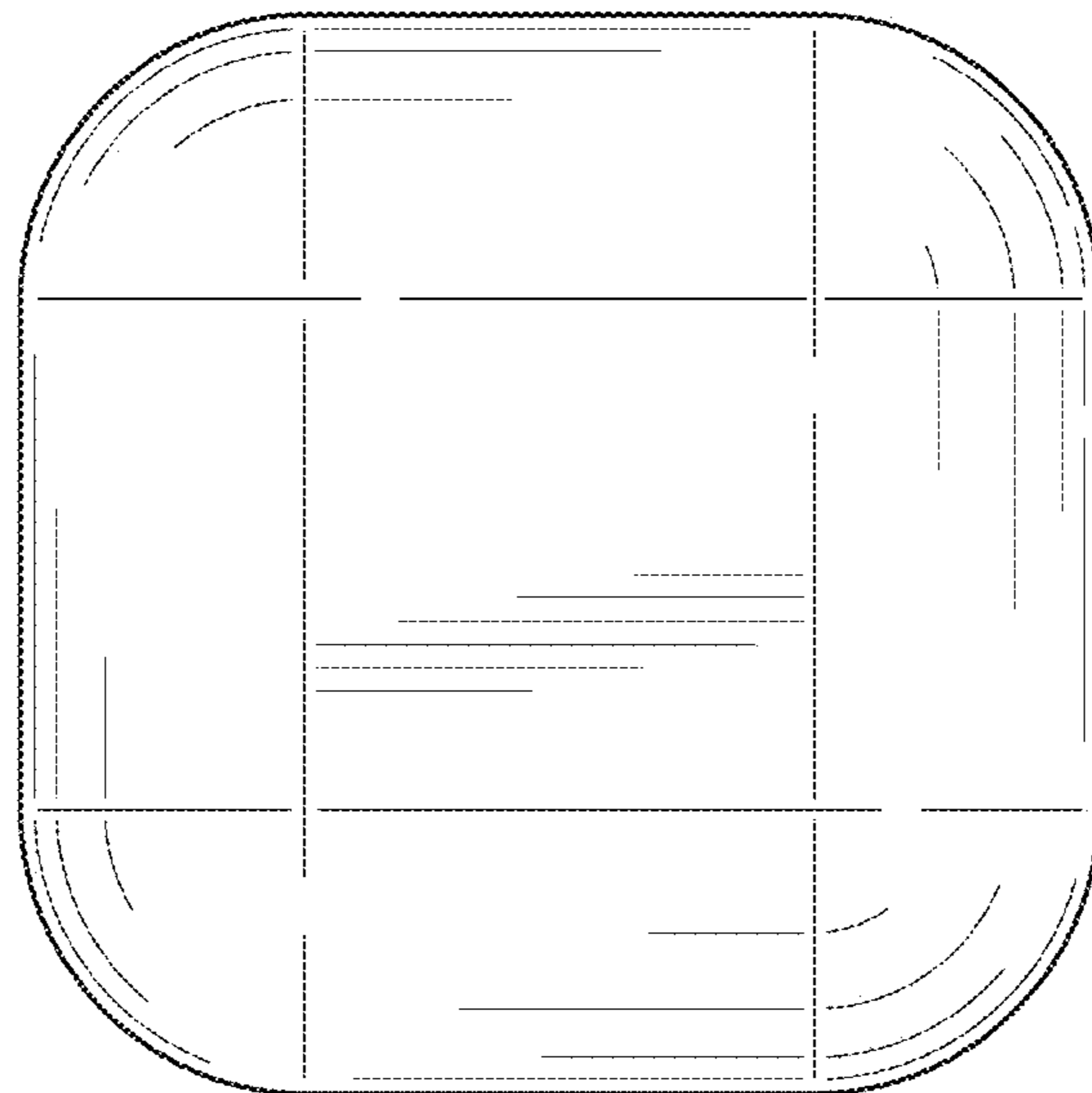

FIG. 35

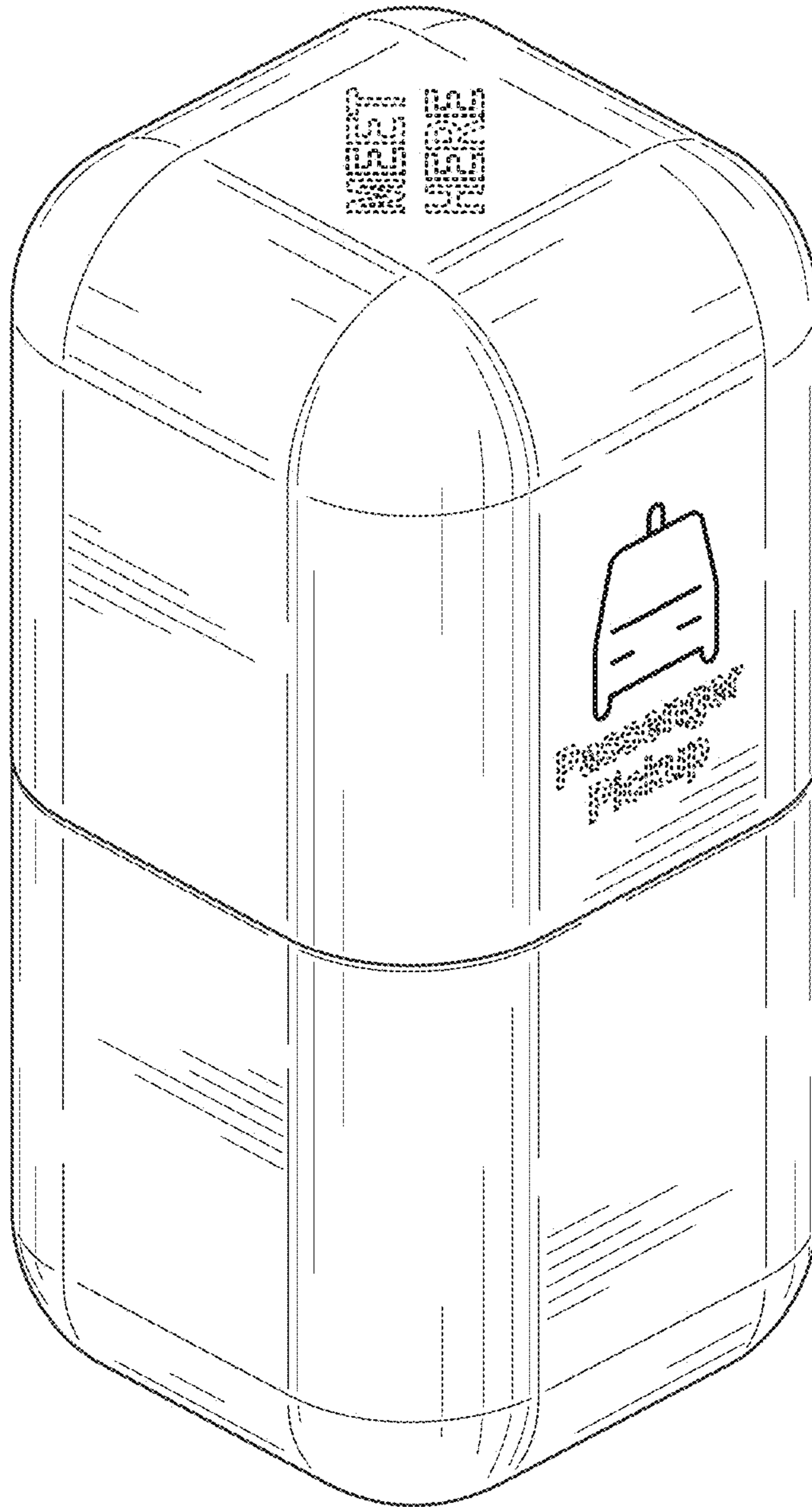

FIG. 36

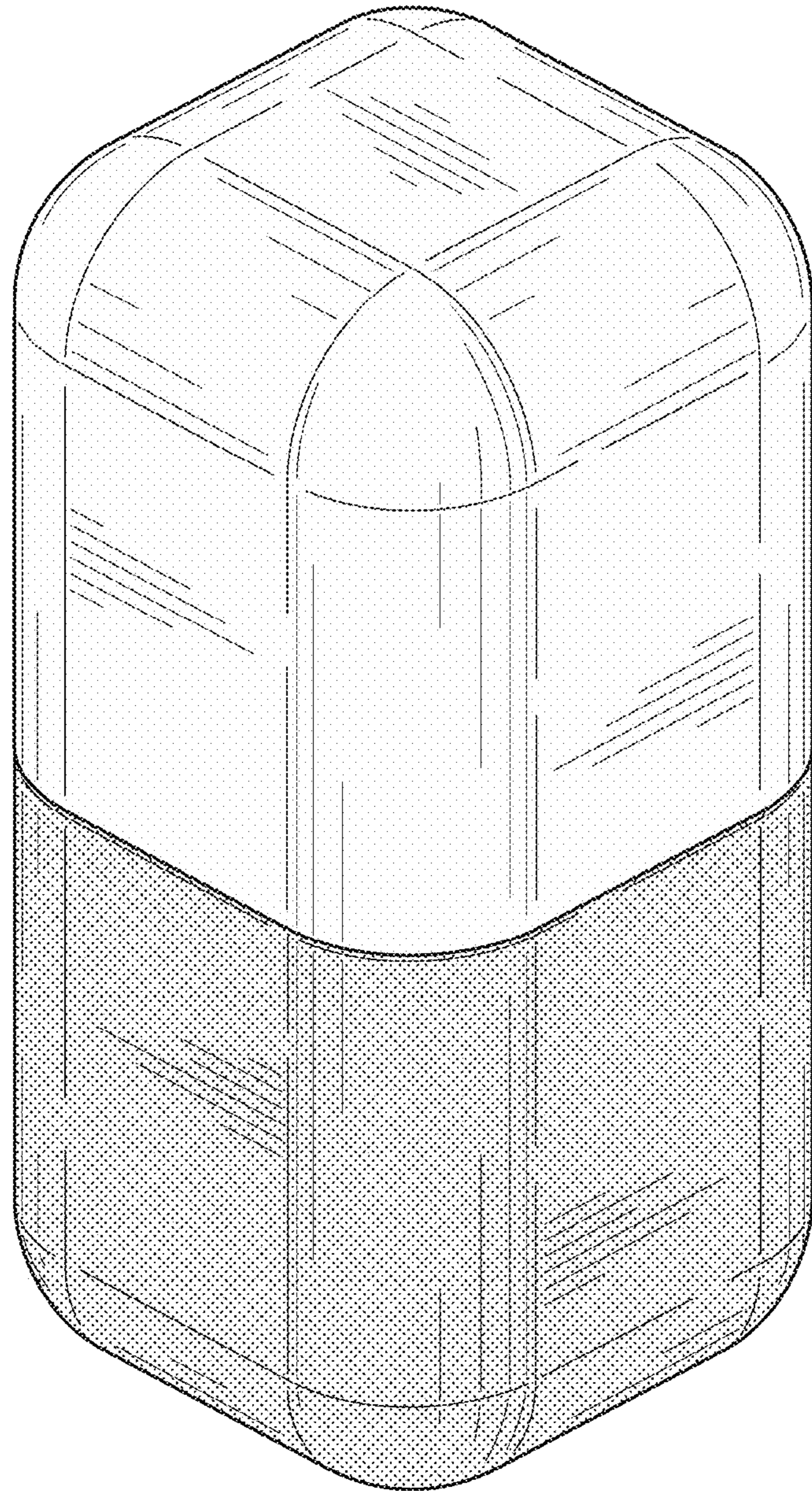

FIG. 37

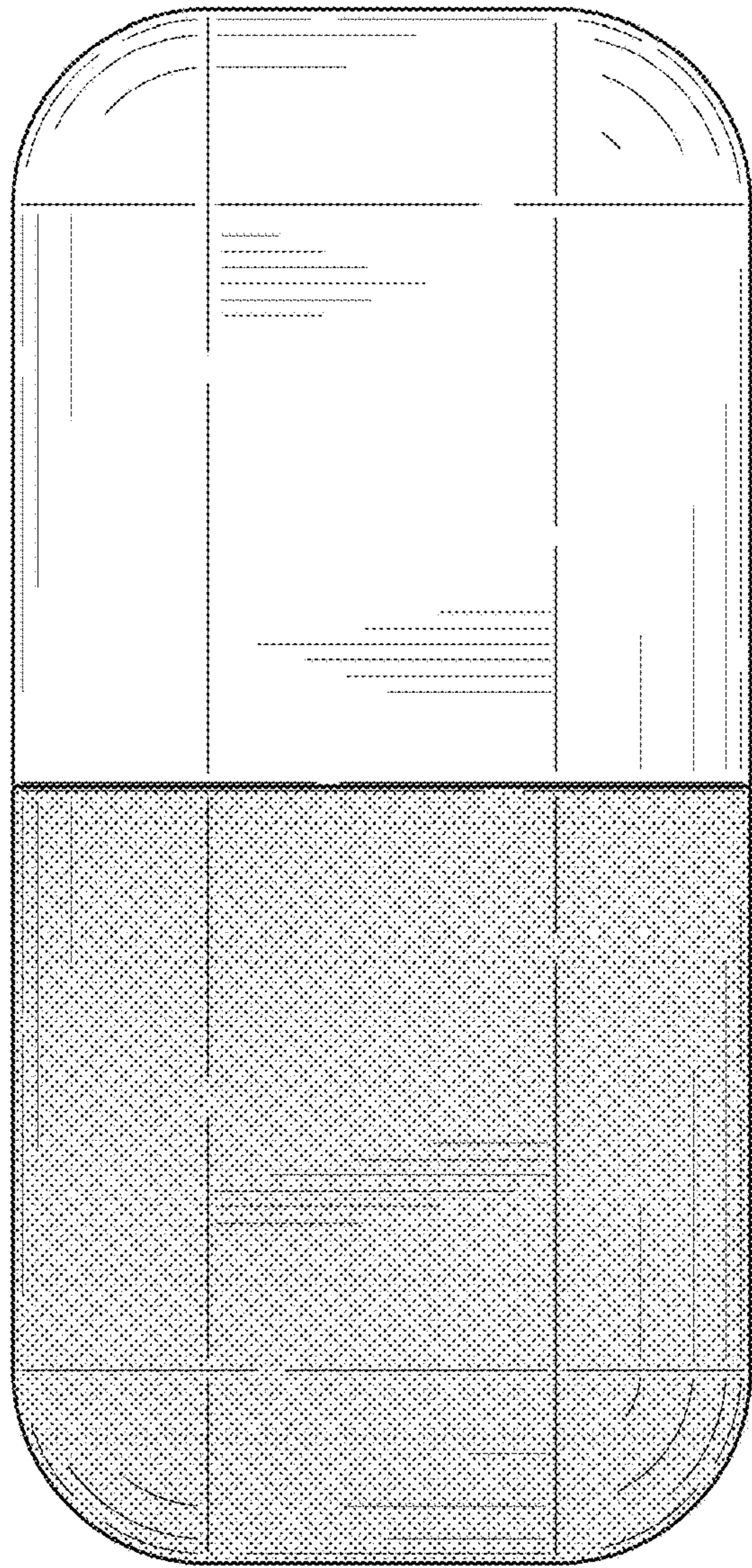

FIG. 38

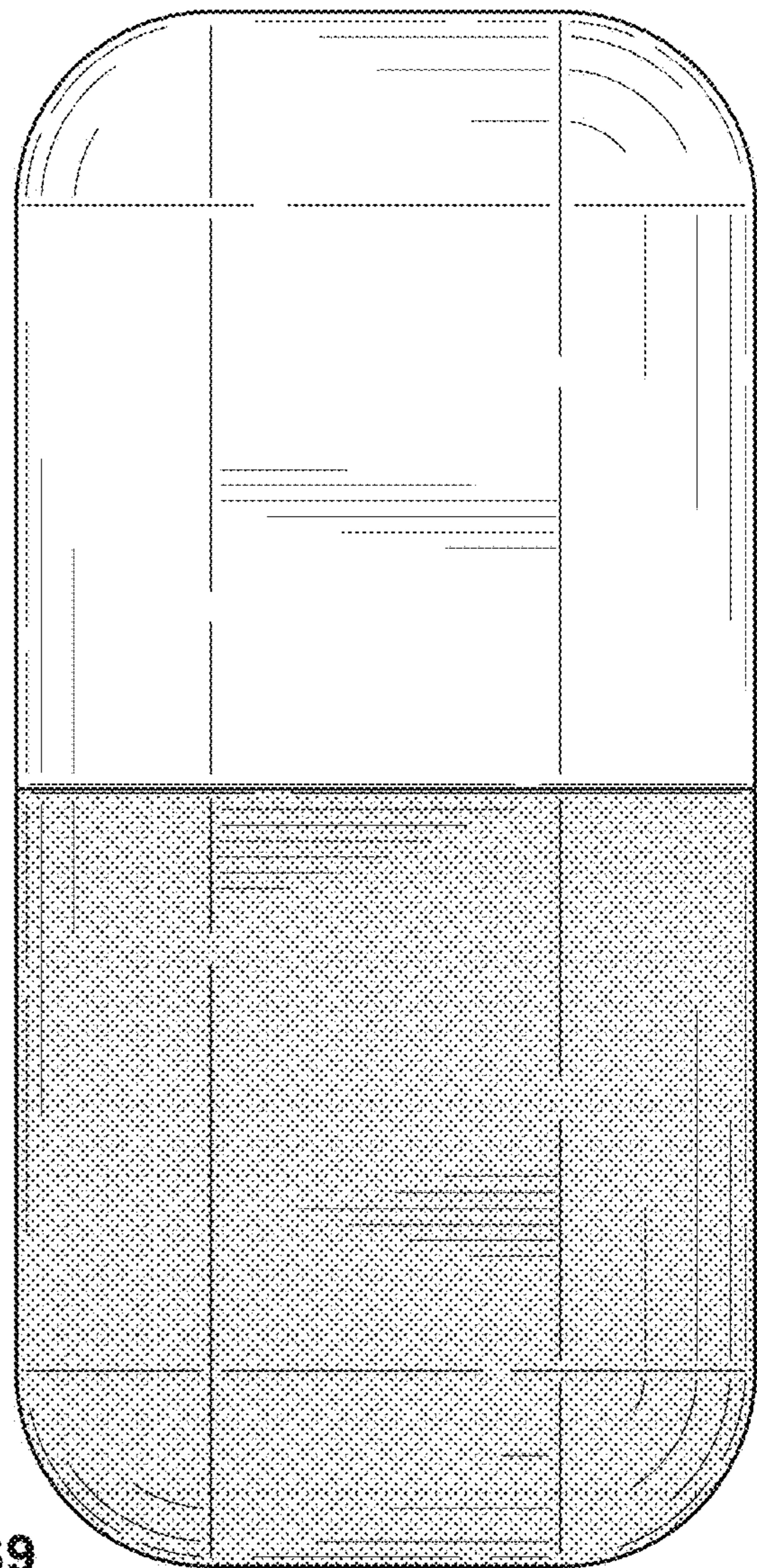

FIG. 39

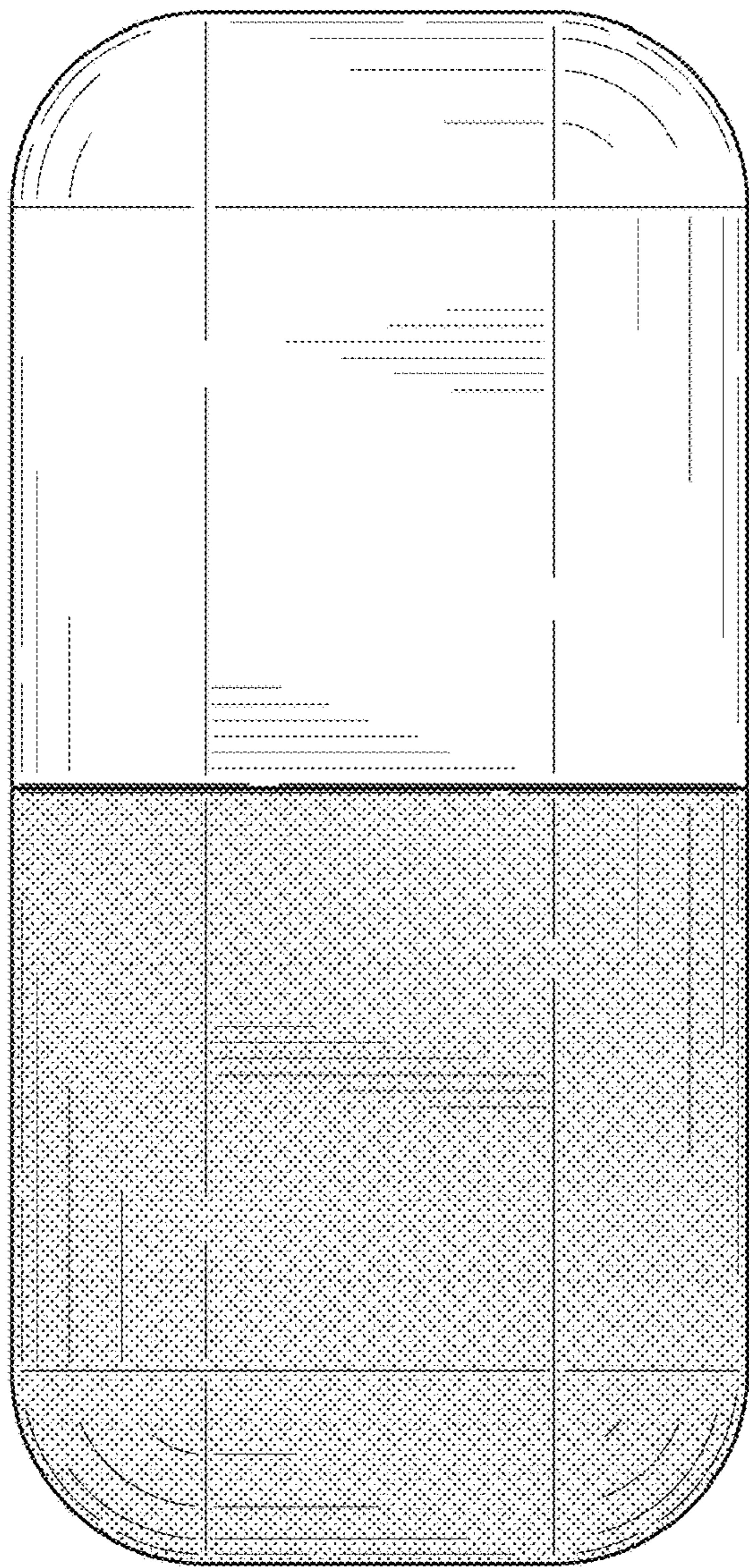

FIG. 40

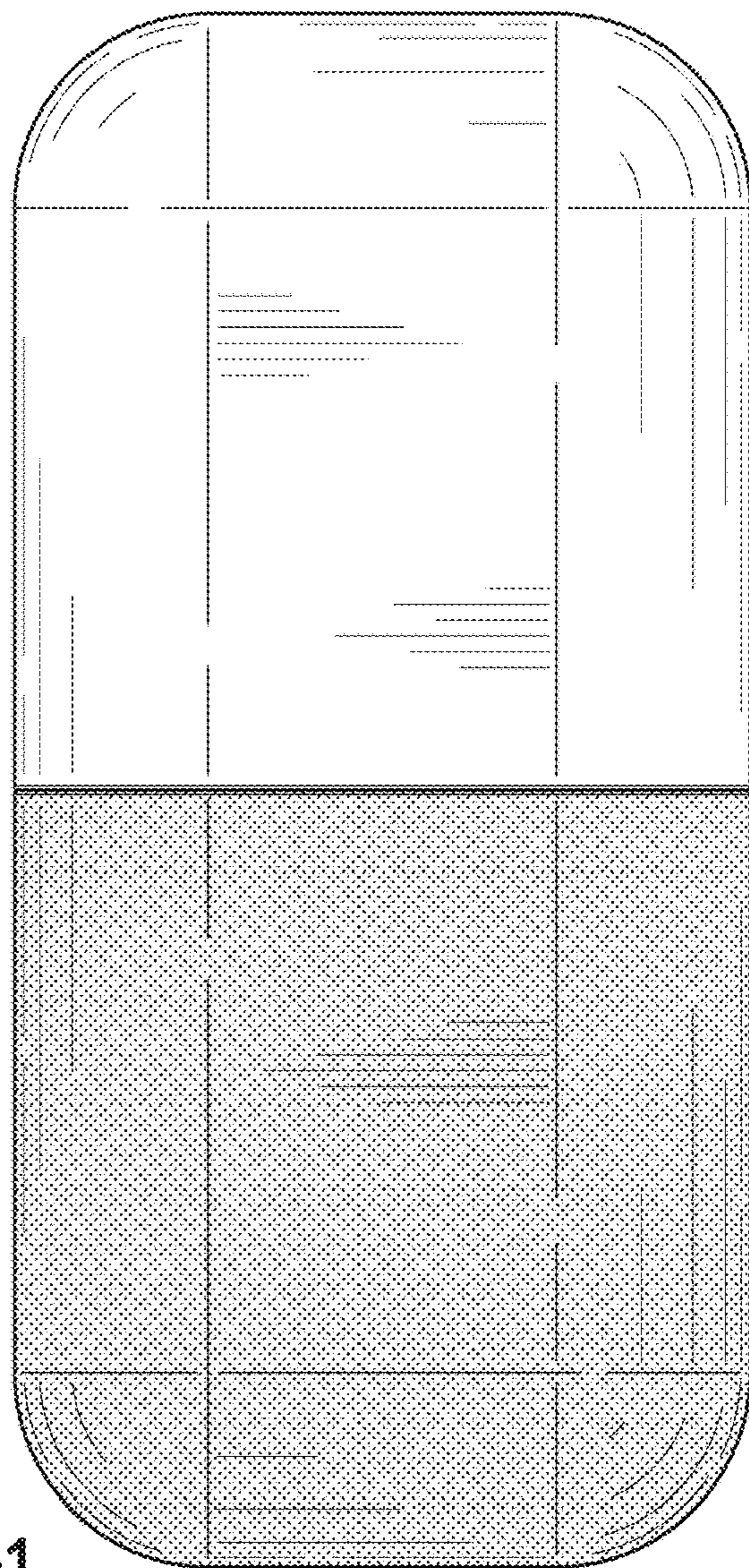

FIG. 41

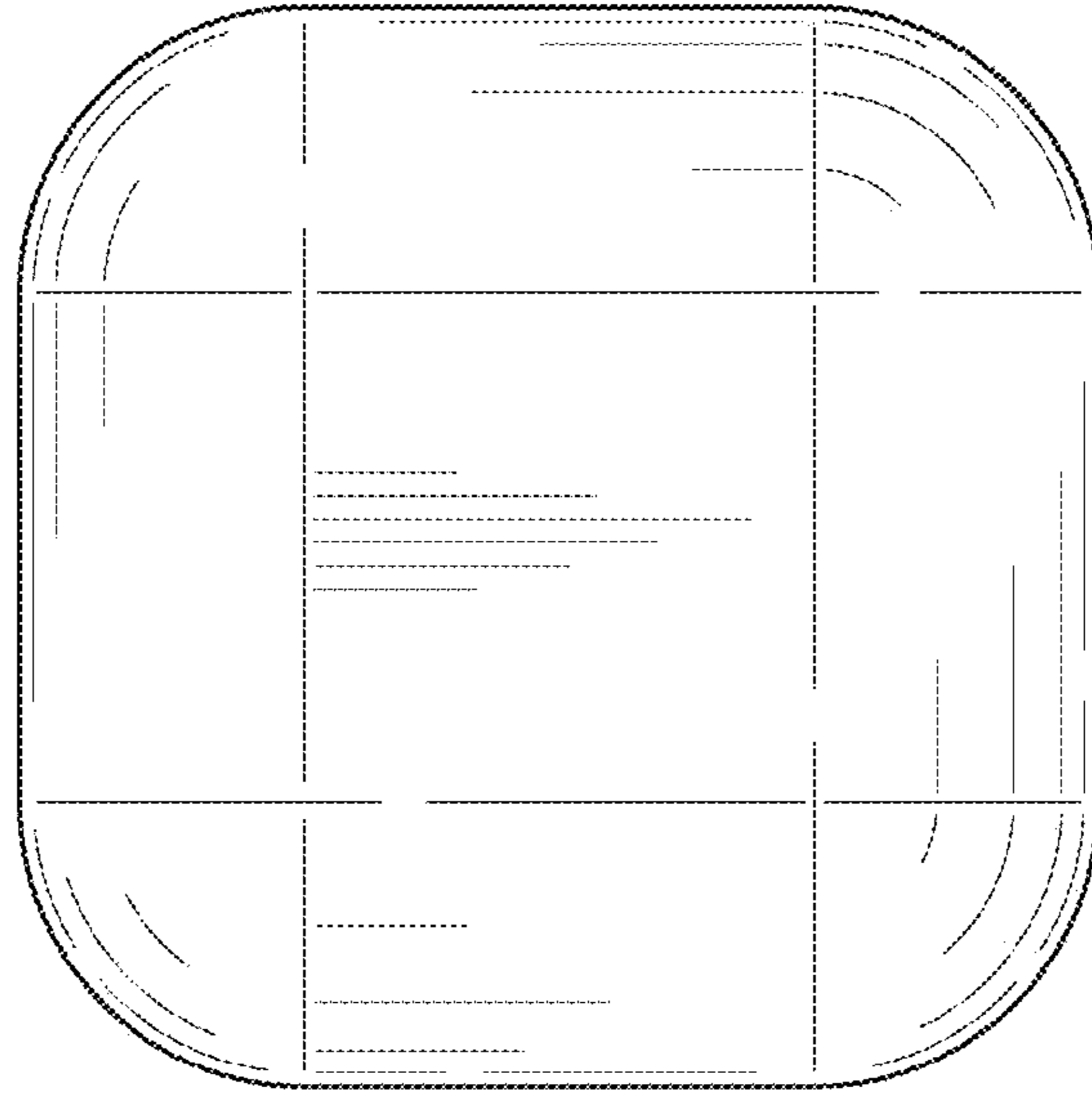

FIG. 42

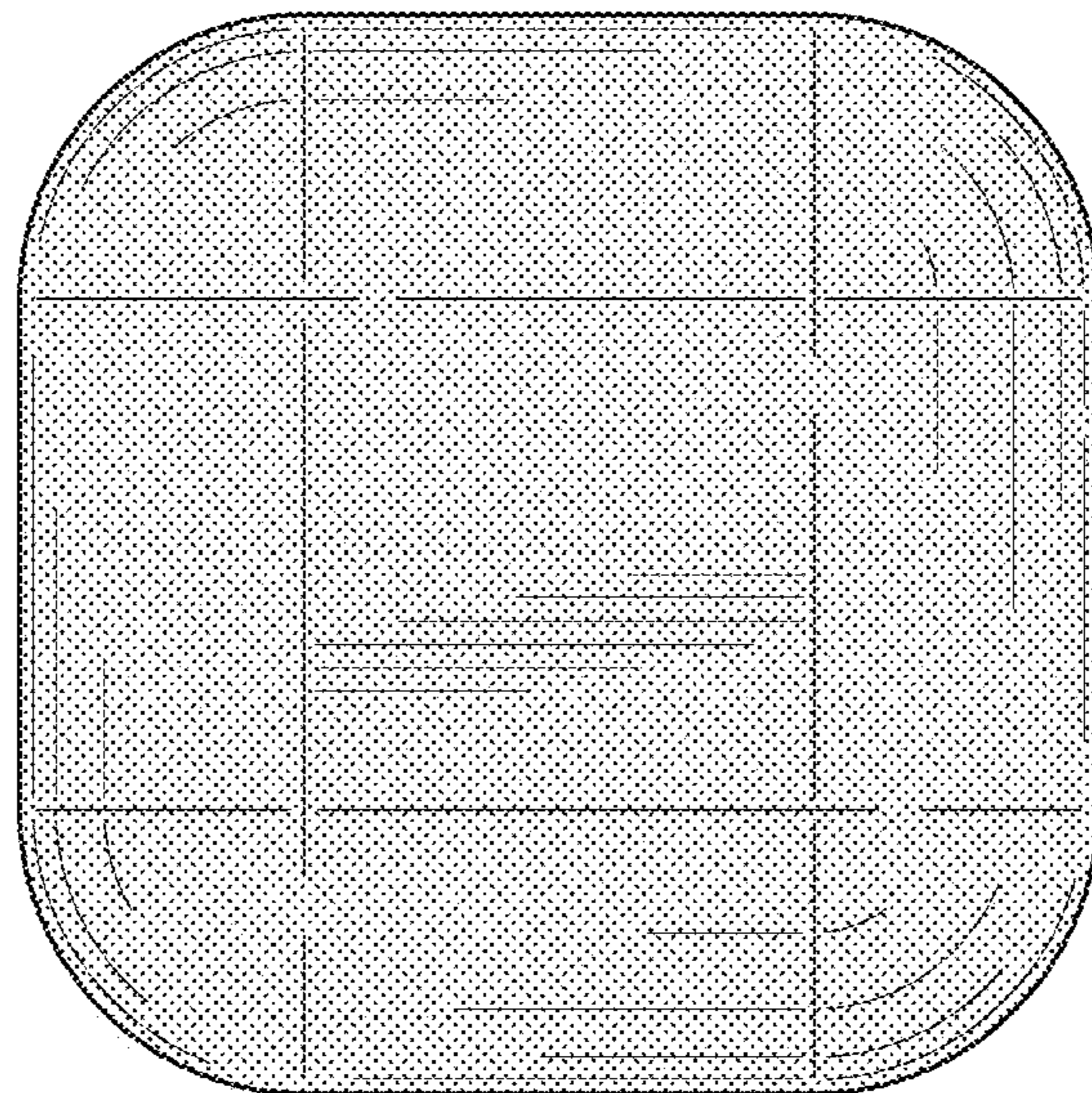

FIG. 43

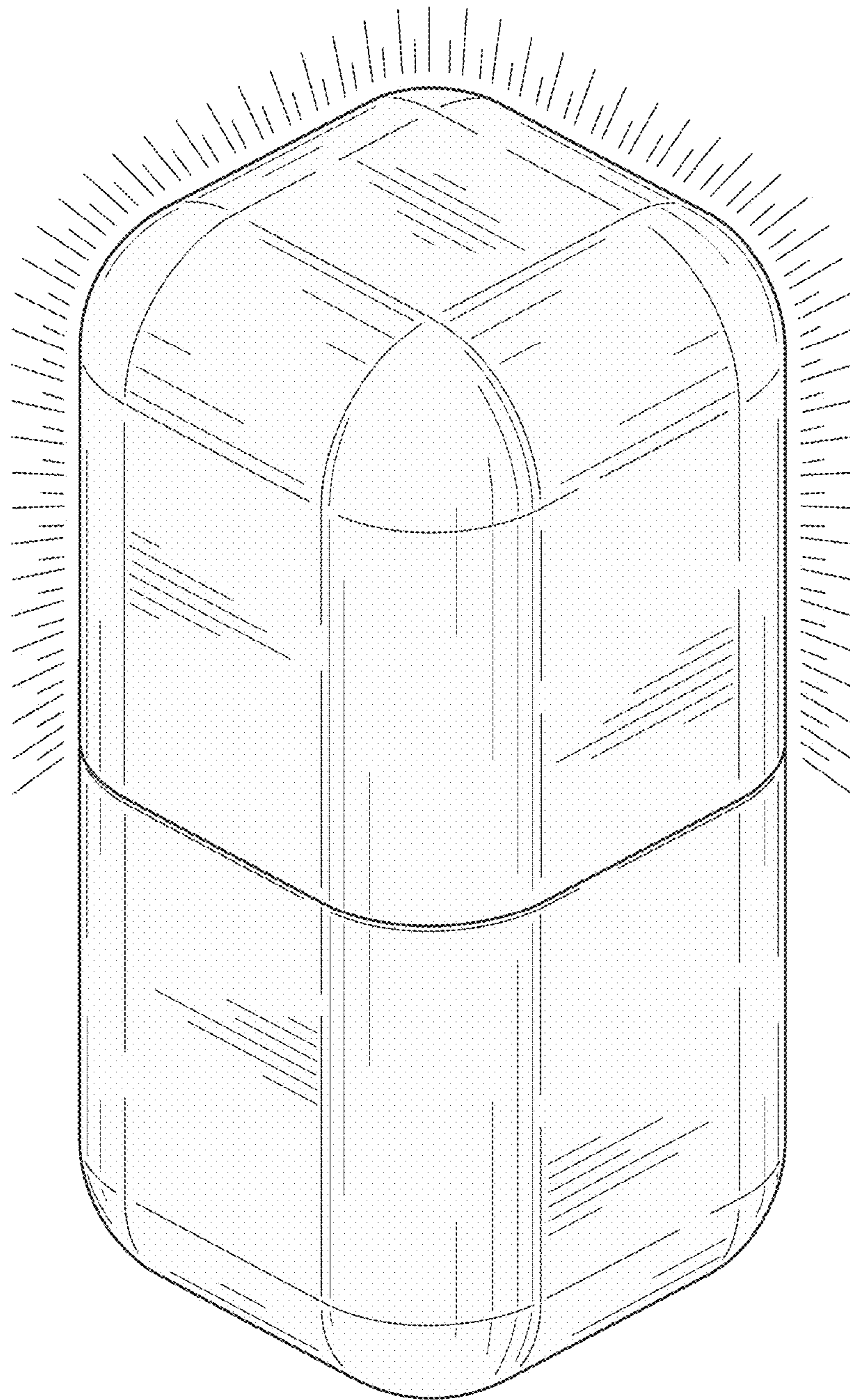

FIG. 44

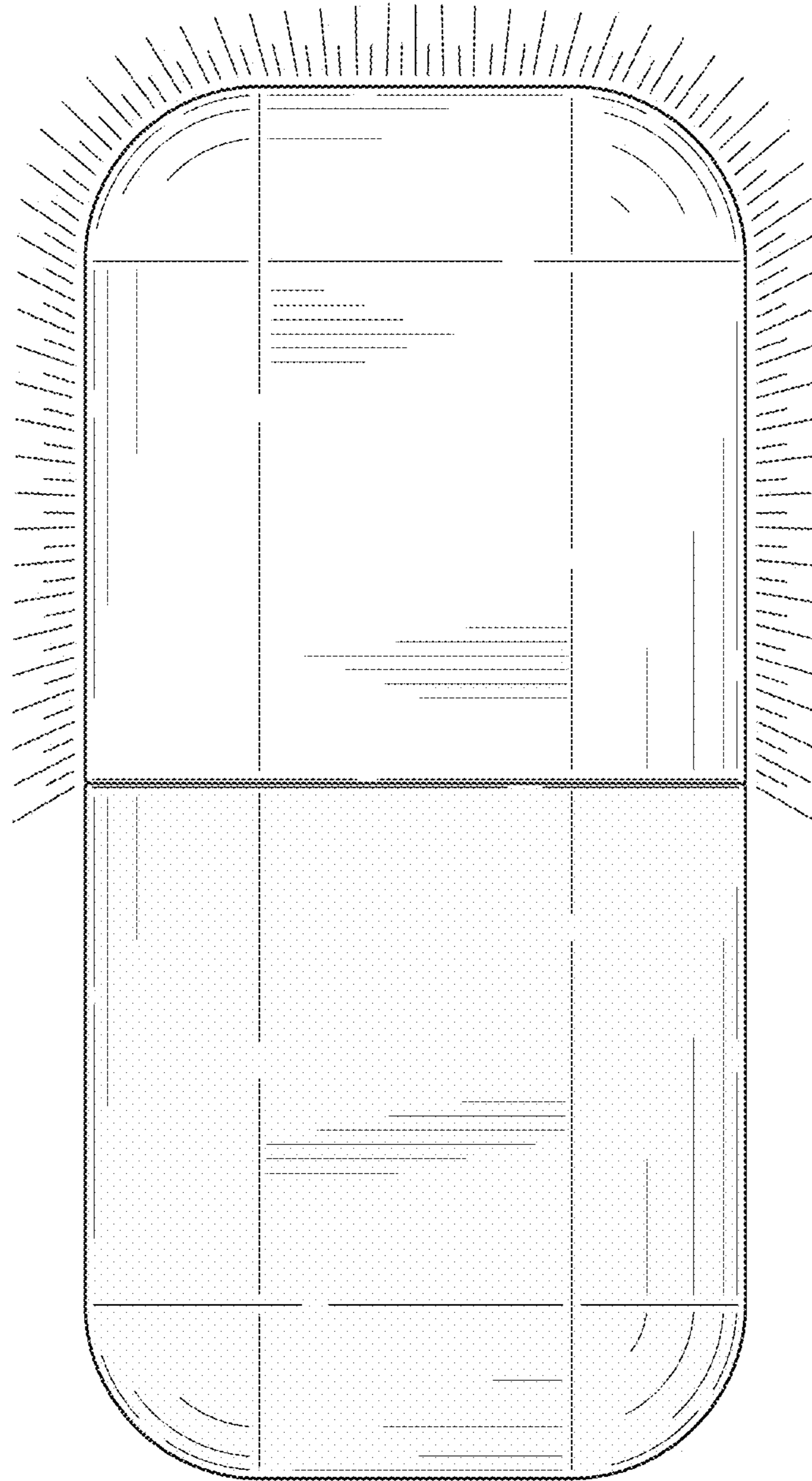

FIG. 45

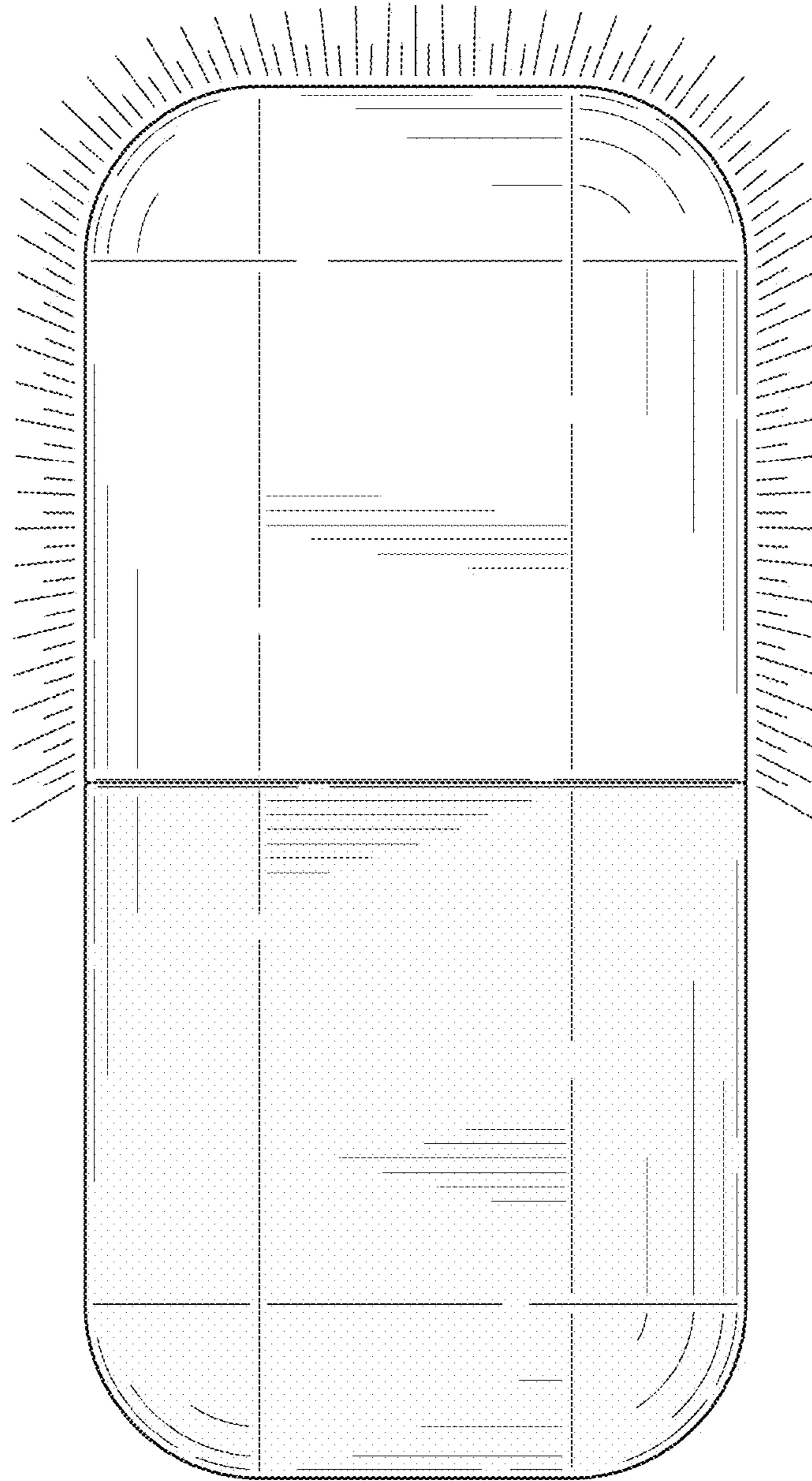

FIG. 46

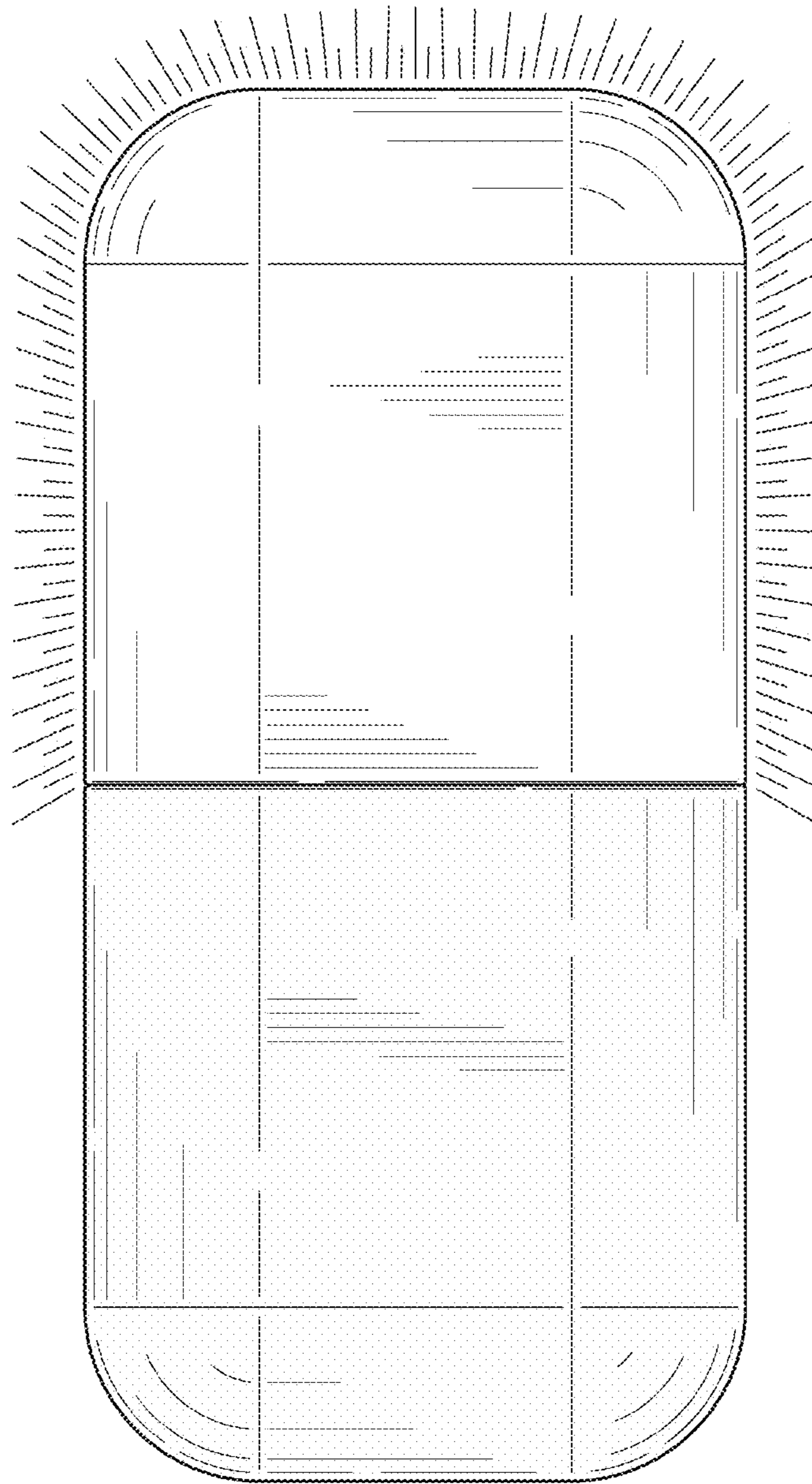

FIG. 47

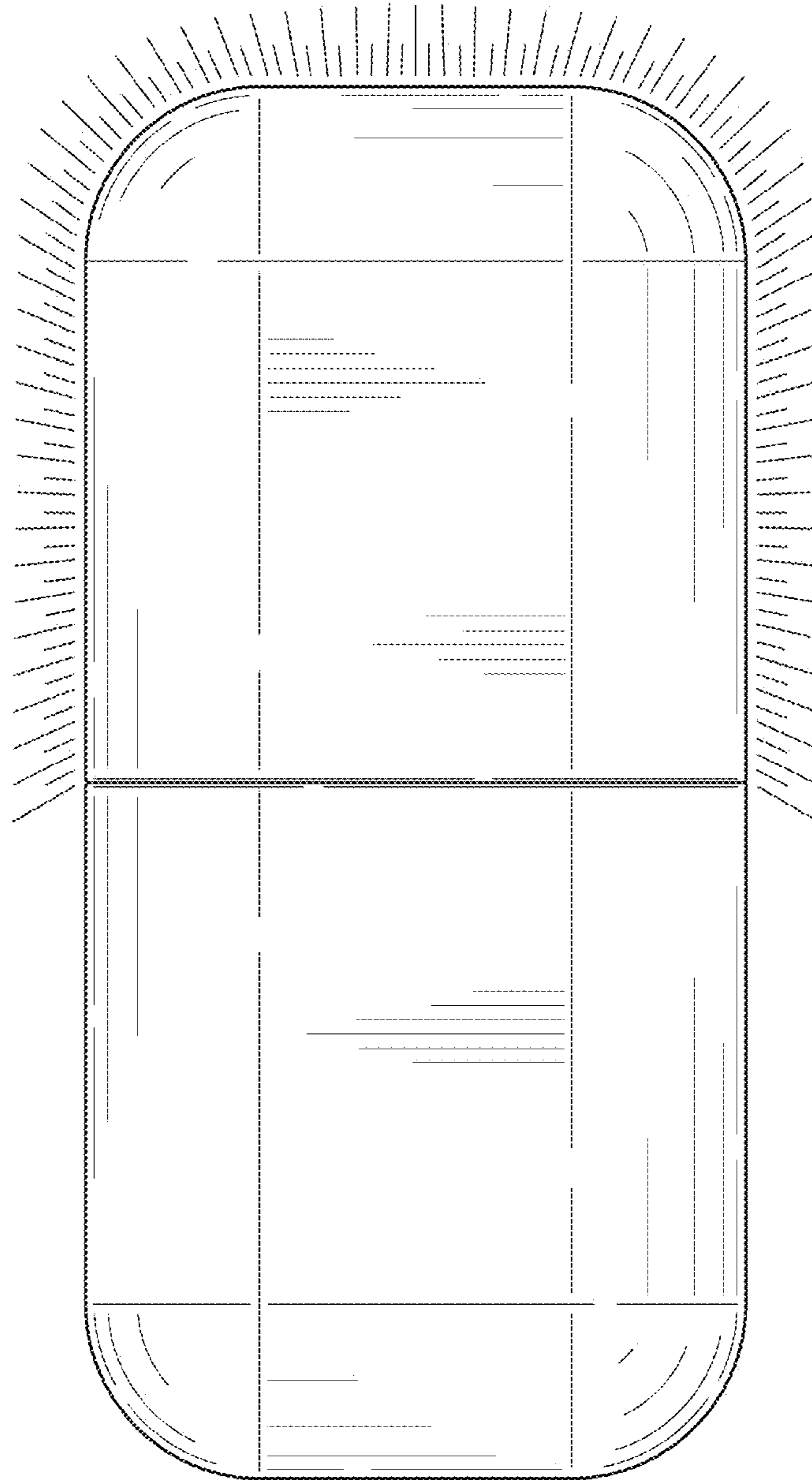

FIG. 48

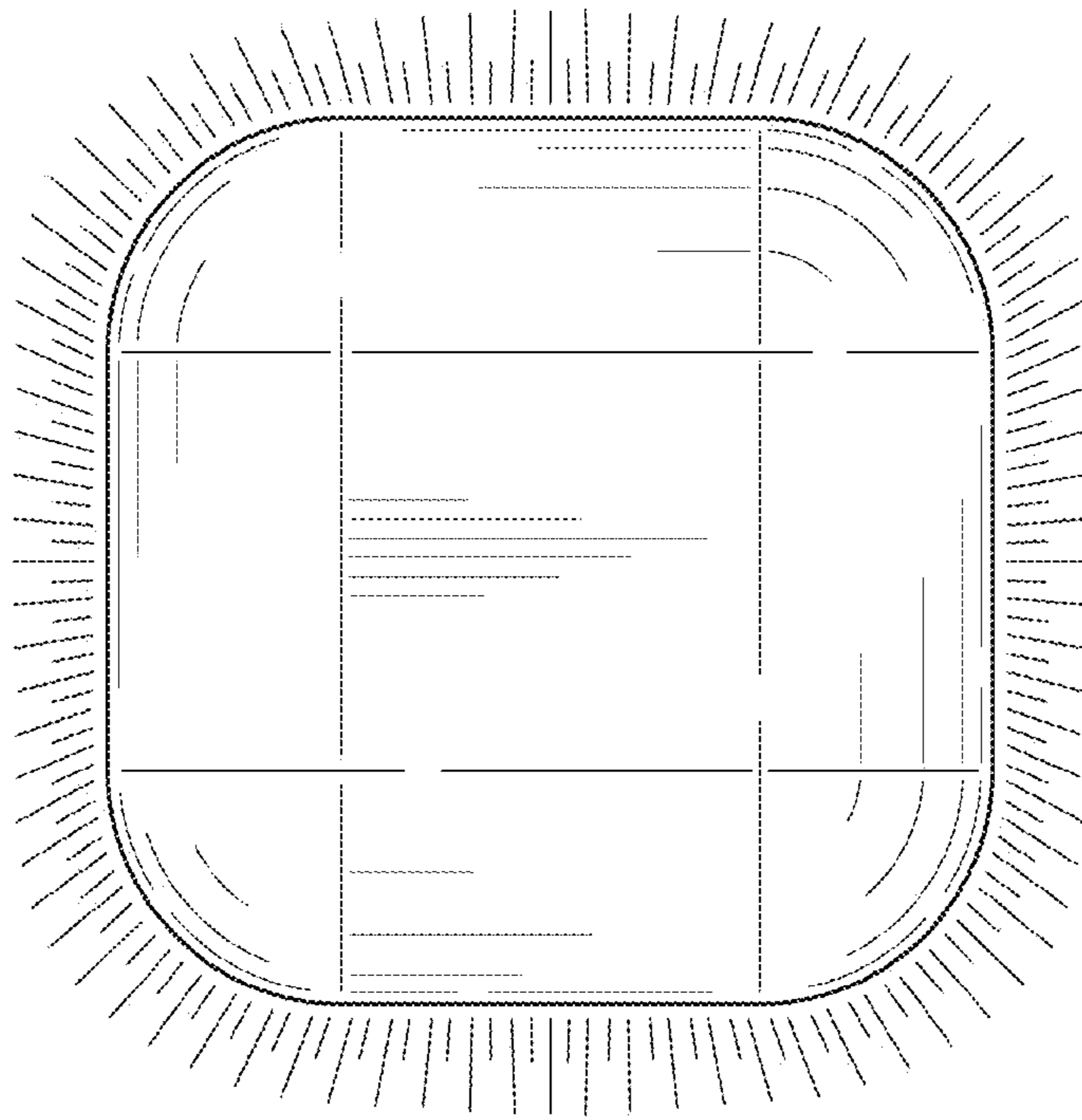

FIG. 49

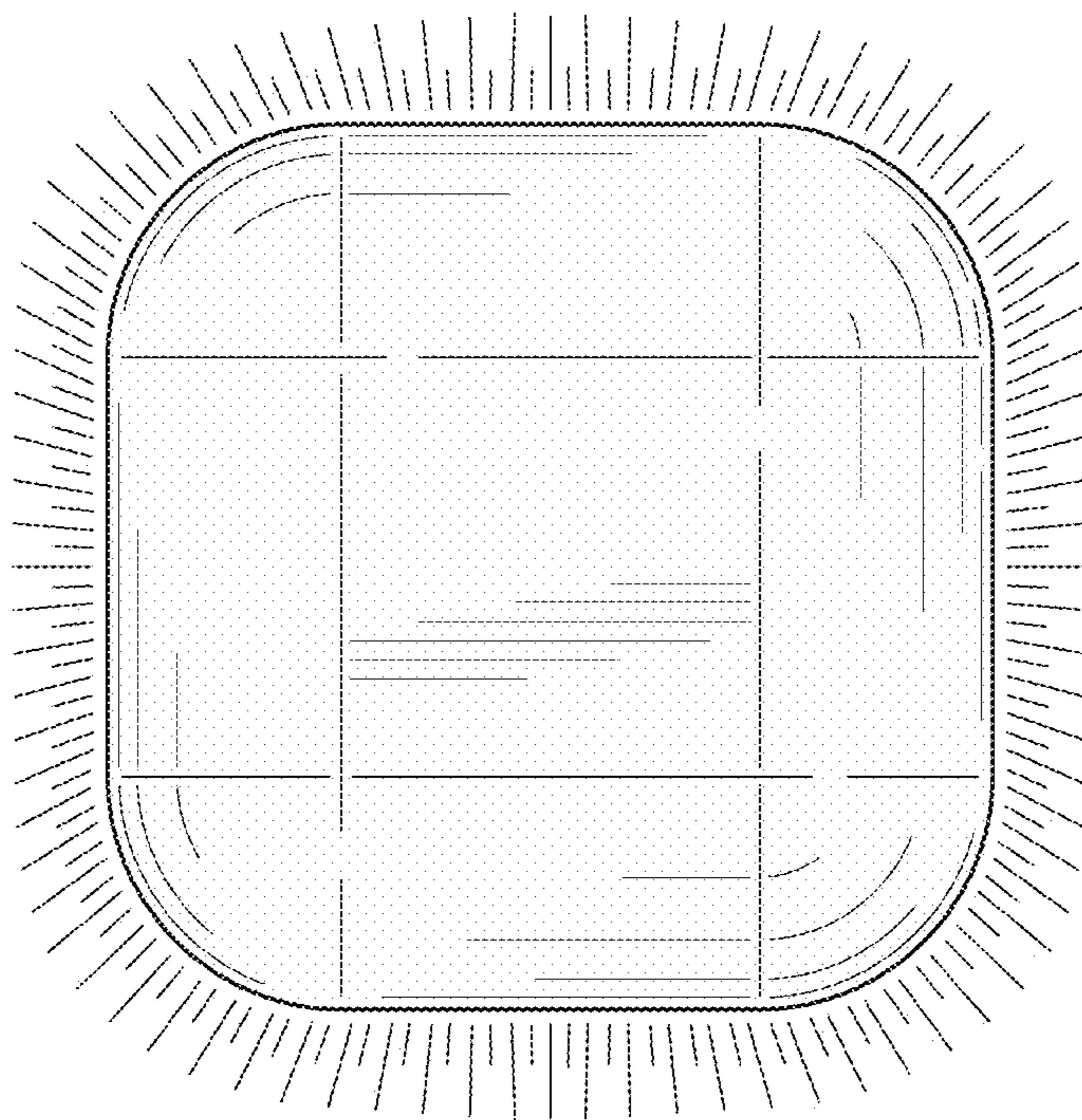

FIG. 50

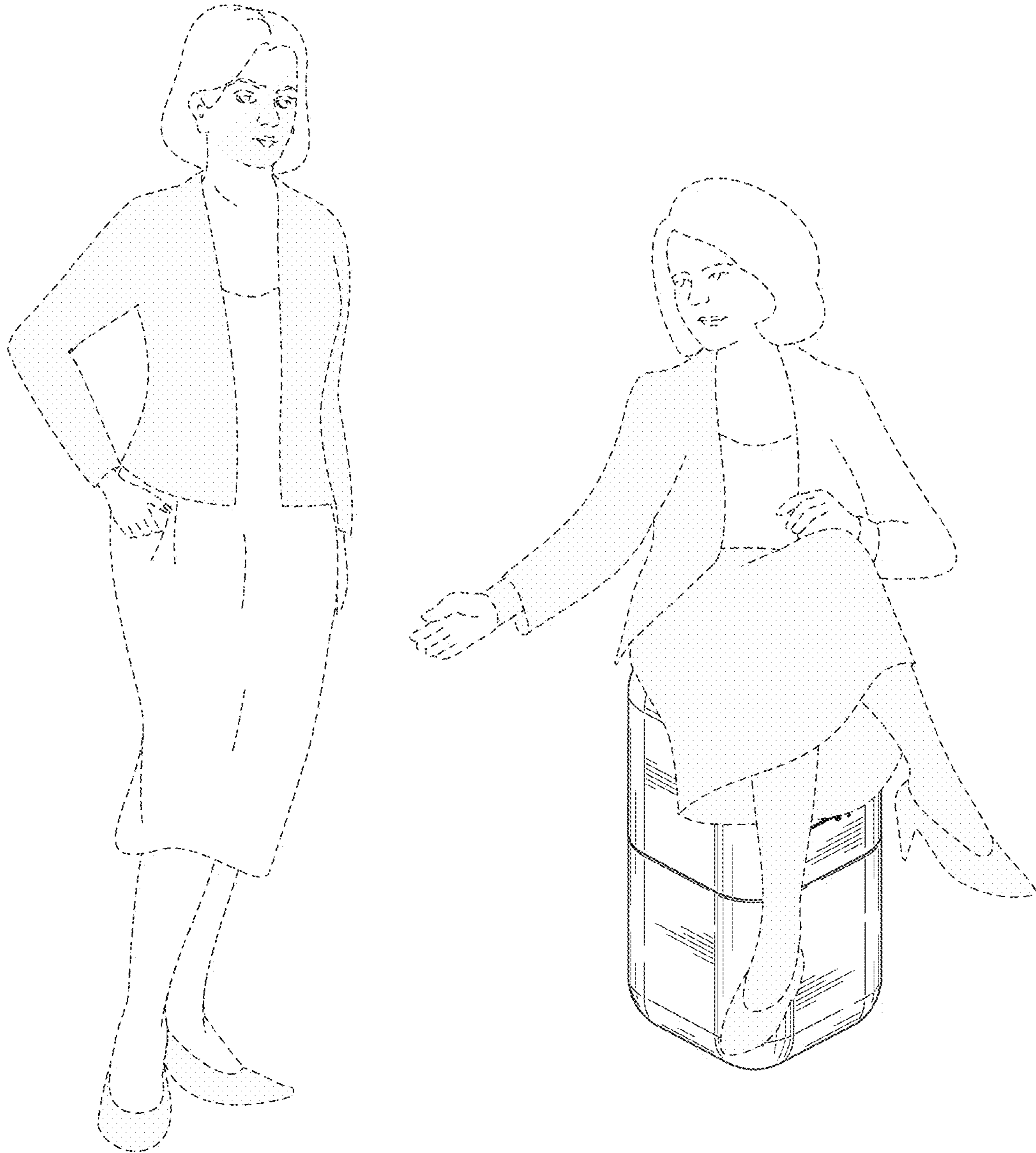

FIG. 51

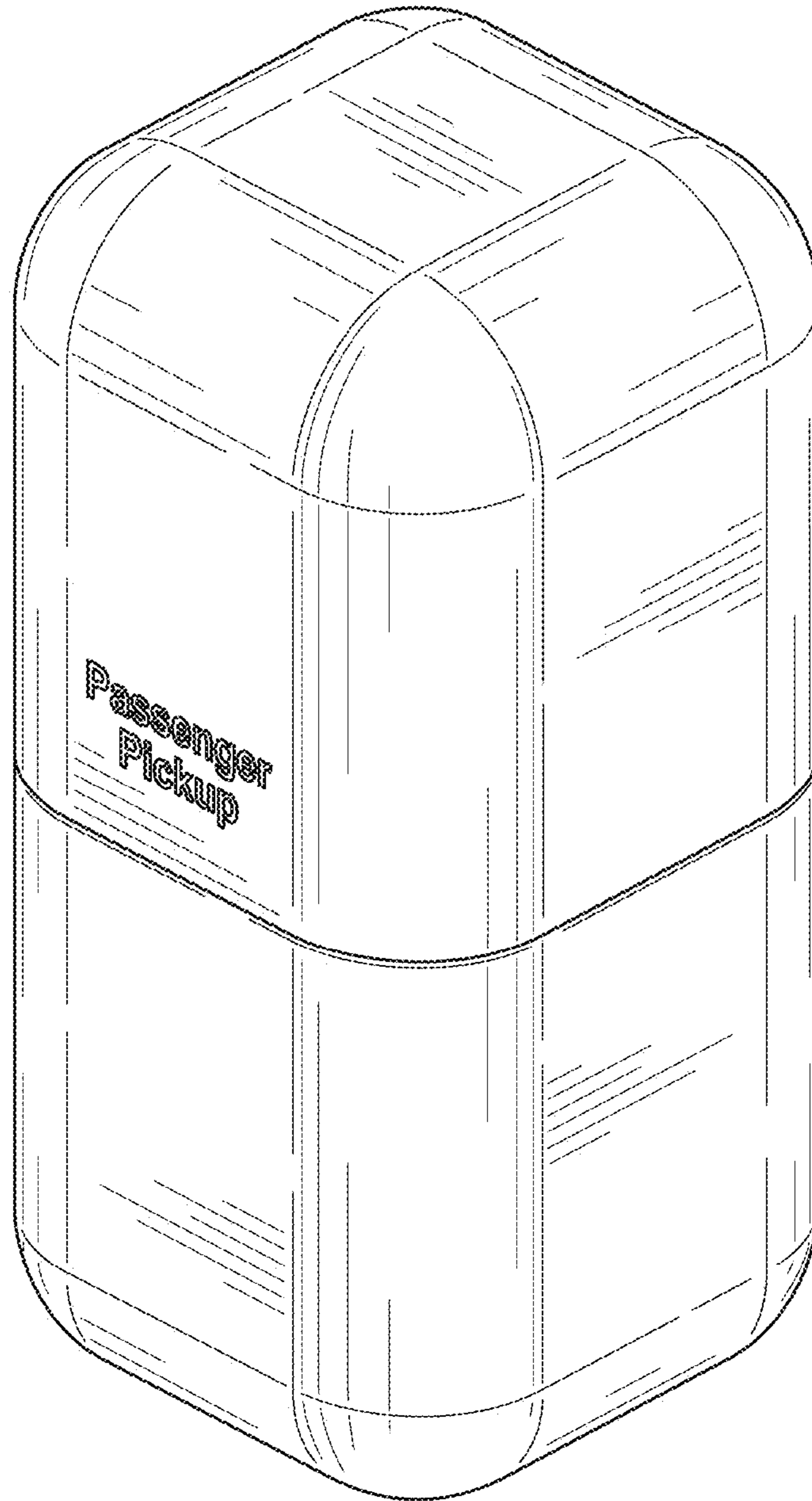

FIG. 52

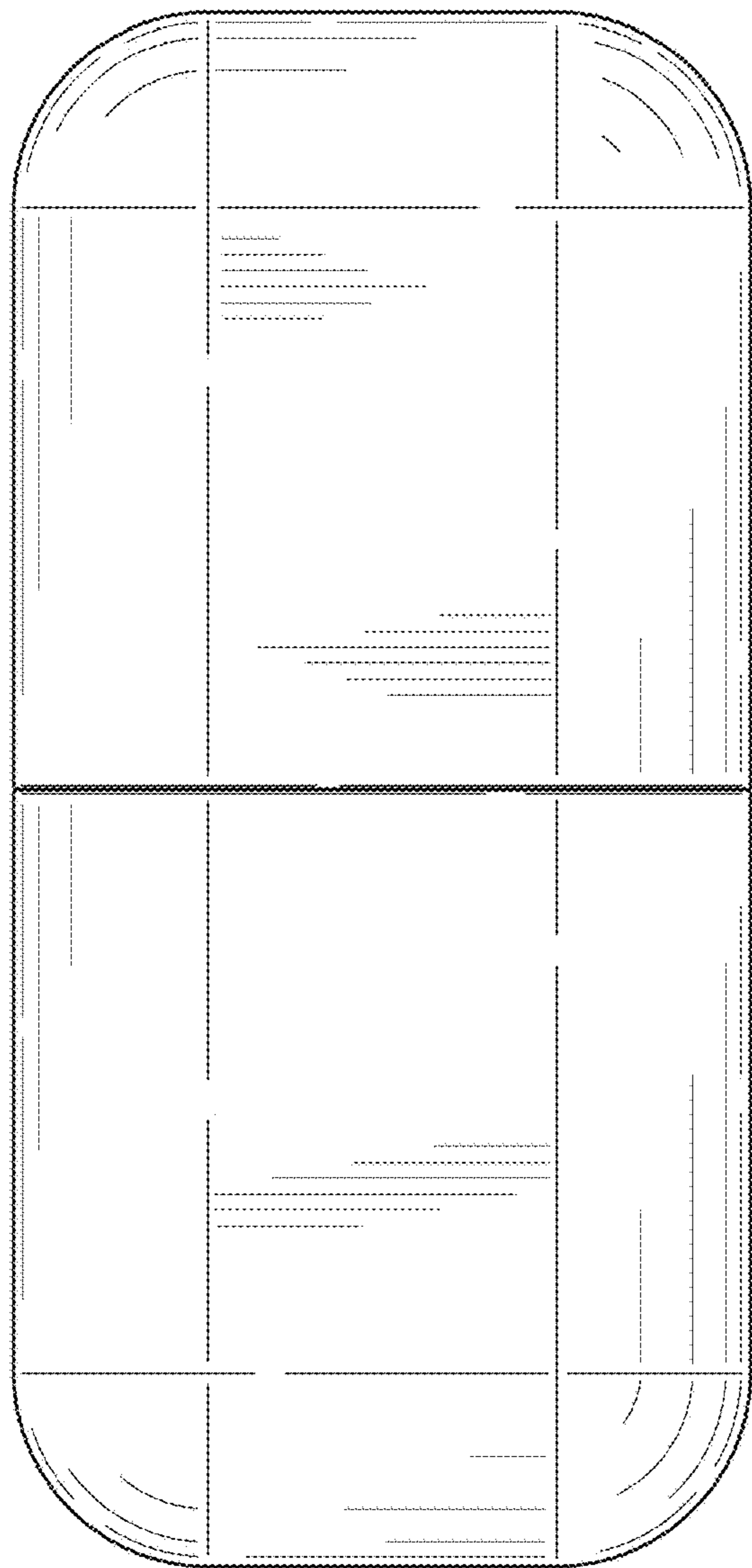

FIG. 53

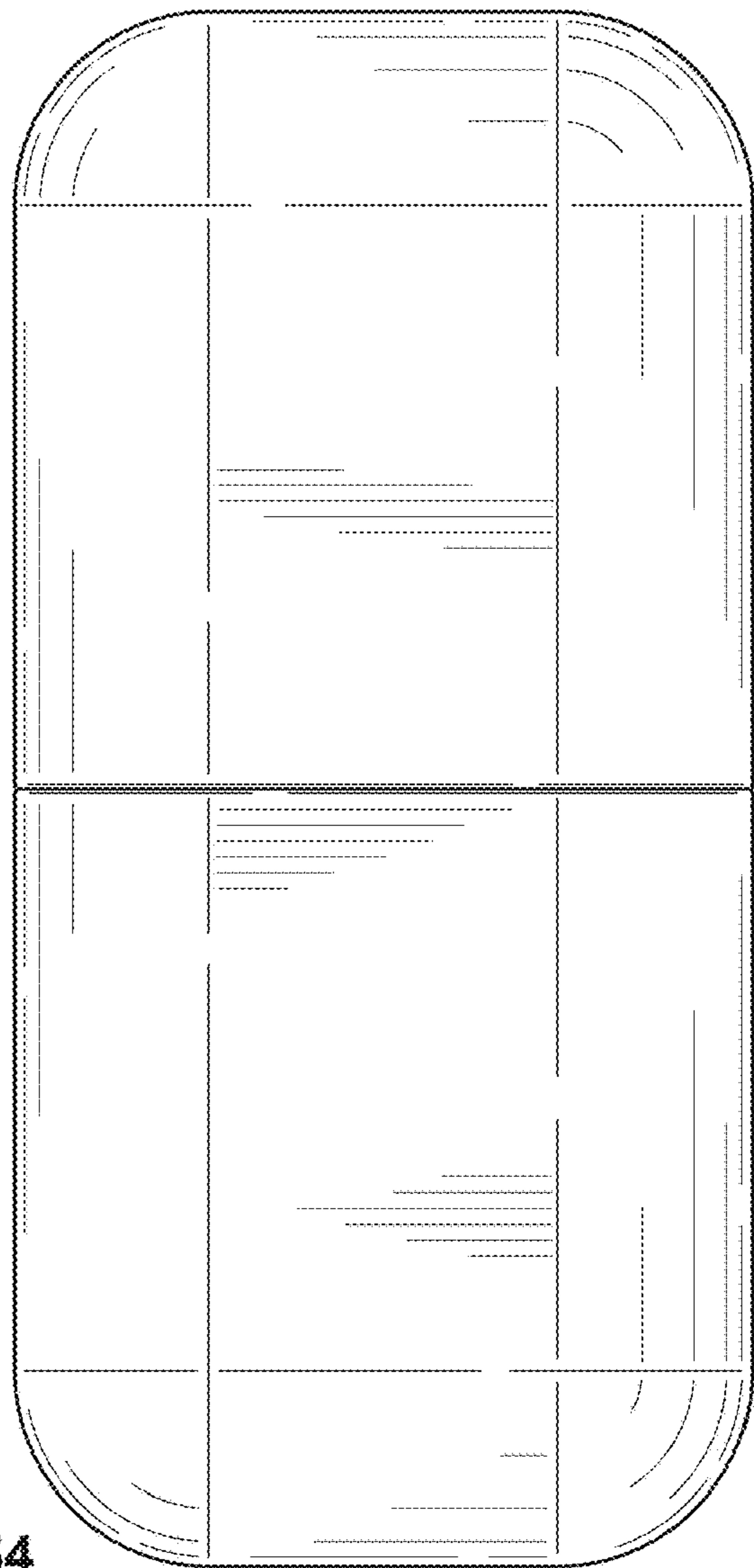

FIG. 54

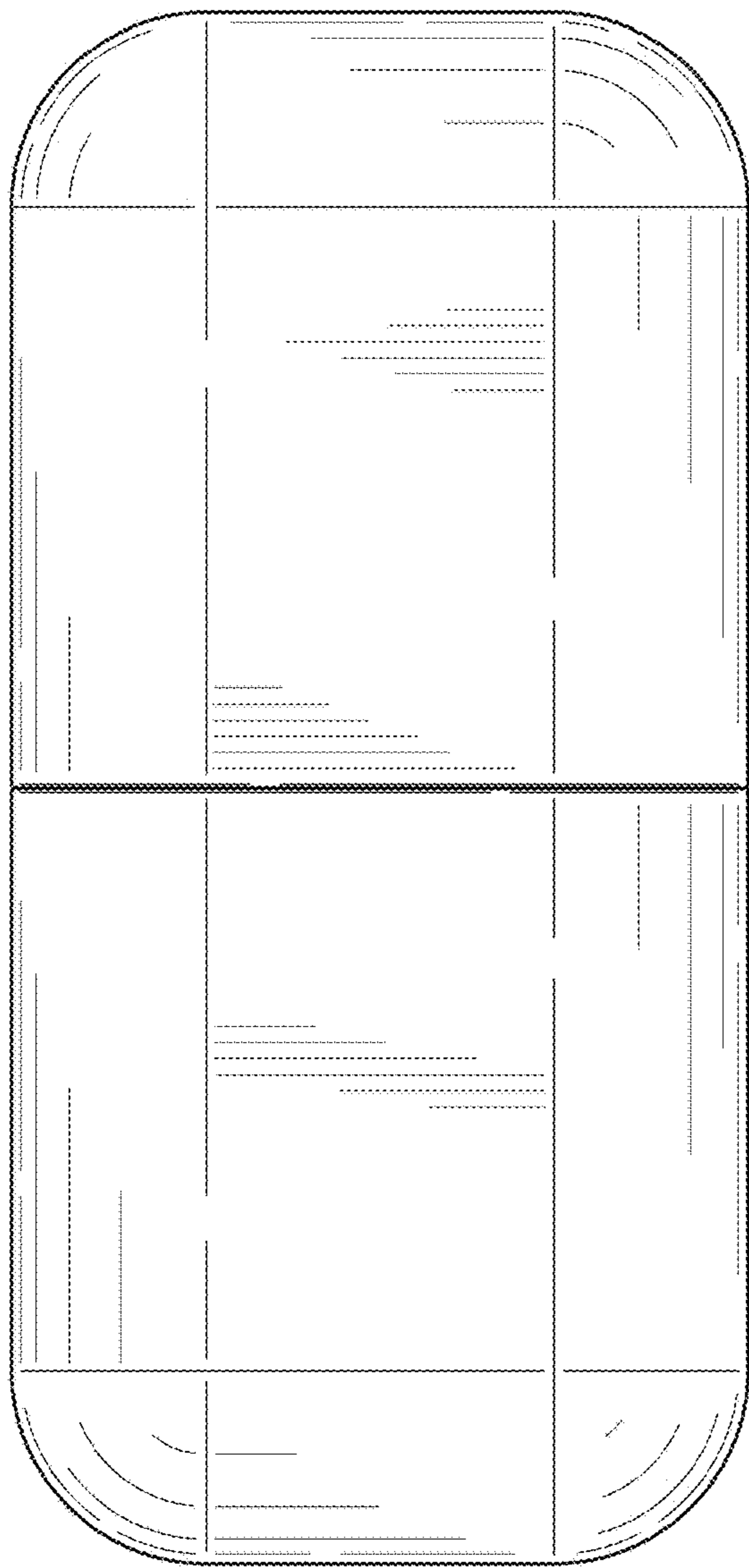

FIG. 55

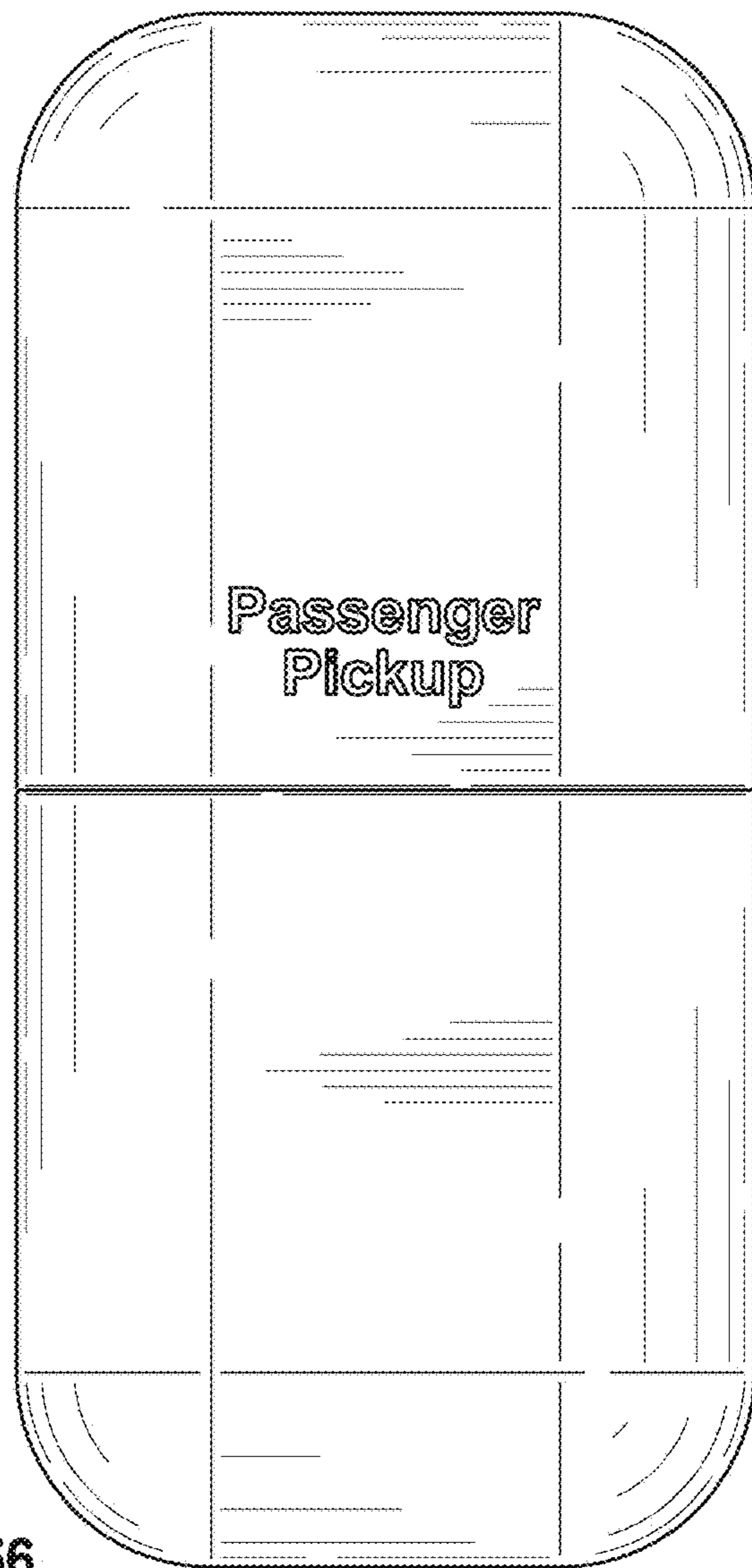

FIG. 56

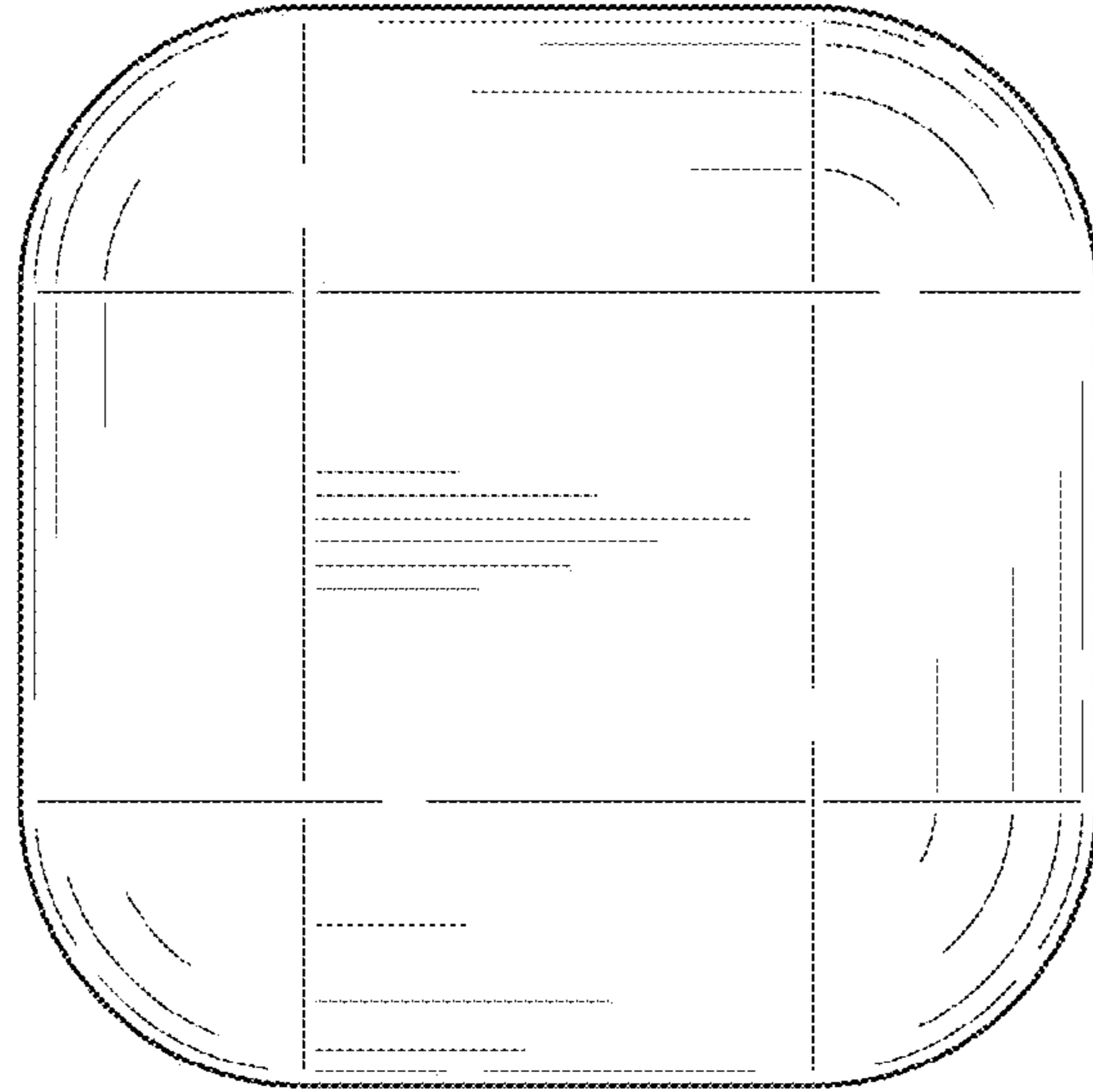

FIG. 57

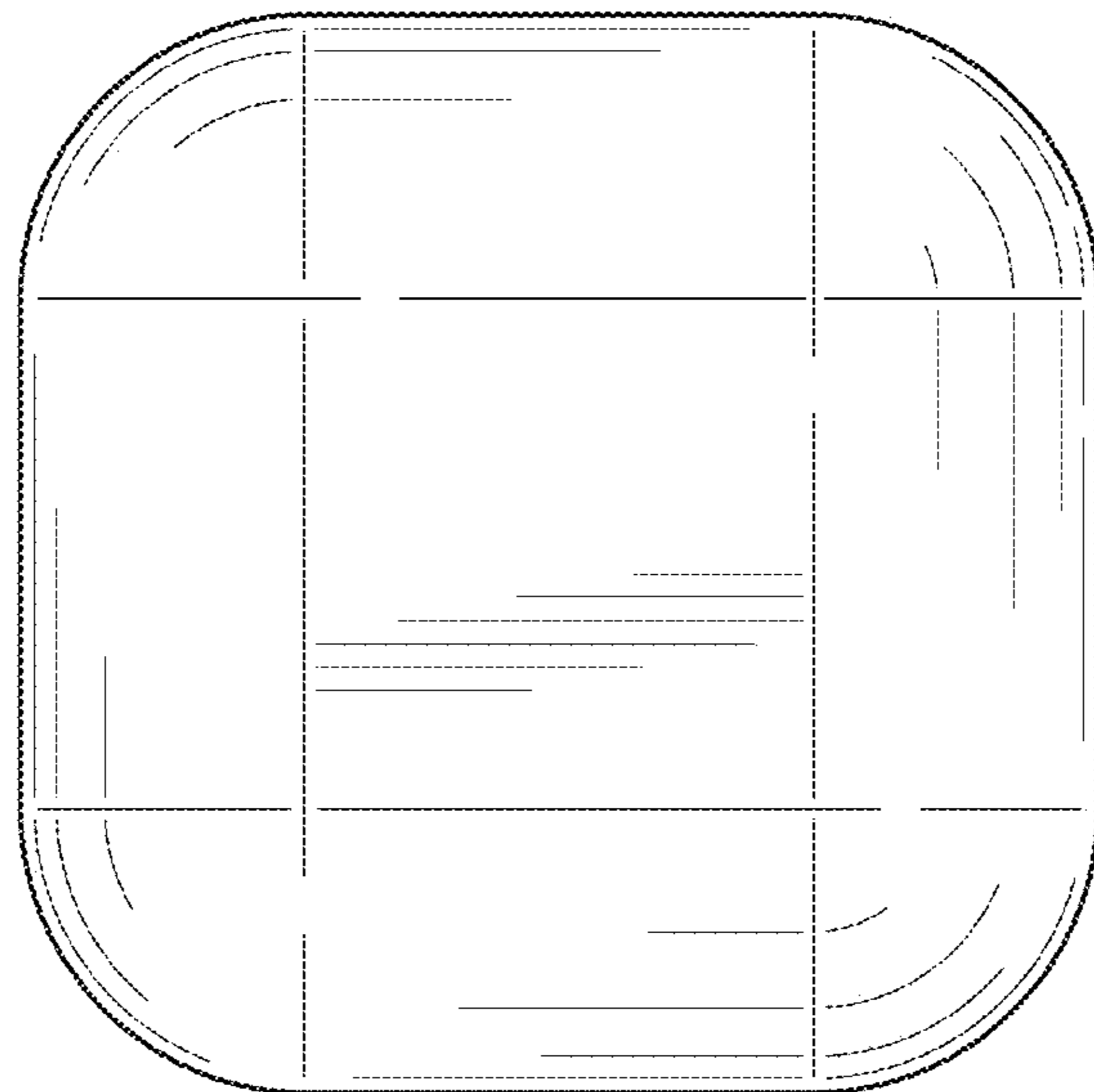

FIG. 58