



US00D893922S

(12) **United States Design Patent** (10) **Patent No.:** **US D893,922 S**
DeJesus et al. (45) **Date of Patent:** **** Aug. 25, 2020**

(54) **RETAIL FIXTURE**

FOREIGN PATENT DOCUMENTS

(71) Applicant: **Apple Inc.**, Cupertino, CA (US)

DE 40110180-0009 7/2003
JP D1345526 S 12/2008

(72) Inventors: **Manuel DeJesus**, San Francisco, CA (US); **Joshua Robert Edwards**, Santa Cruz, CA (US); **Jean-Marc Gady**, Los Altos, CA (US); **Wesley Bryan Hamm**, San Francisco, CA (US); **Russell John Kaaihue Heirakuji**, Cupertino, CA (US); **Allison Inouye**, San Francisco, CA (US); **Moritz Wilsberg**, Rheinbreitbach (DE)

(Continued)

OTHER PUBLICATIONS

Japanese Patent Office document HB11011472, Abitare Magazine, p. 61, vol. 386 (2 Pages).

(Continued)

Primary Examiner — Kelley A Donnelly

(73) Assignee: **Apple Inc.**, Cupertino, CA (US)

(74) *Attorney, Agent, or Firm* — Sterne, Kessler, Goldstein & Fox, P.L.L.C.

(**) Term: **15 Years**

(57) **CLAIM**

(21) Appl. No.: **29/727,168**

The ornamental design for a retail fixture, as shown and described.

(22) Filed: **Mar. 9, 2020**

DESCRIPTION

Related U.S. Application Data

(63) Continuation of application No. 29/655,963, filed on Jul. 9, 2018, now Pat. No. Des. 877,547.

(51) **LOC (12) Cl.** **06-06**

(52) **U.S. Cl.**
USPC **D6/675**

(58) **Field of Classification Search**
USPC D6/675, 675.1, 675.4; D7/589, 590, 601, D7/602; D3/304, 313, 328
CPC A47F 5/00; A47F 5/0018; A47F 5/0043; A47F 7/0007; A47F 7/0014; B65D
(Continued)

FIG. 1 is a top front perspective view of a retail fixture showing the claimed design;
FIG. 2 is a front view thereof;
FIG. 3 is a rear view thereof;
FIG. 4 is a left side view thereof;
FIG. 5 is a right side view thereof;
FIG. 6 is a top view thereof;
FIG. 7 is a bottom view thereof;
FIG. 8 is a top front perspective view of another retail fixture showing the claimed design;
FIG. 9 is a front view thereof;
FIG. 10 is a rear view thereof;
FIG. 11 is a left side view thereof;
FIG. 12 is a right side view thereof;
FIG. 13 is a top view thereof; and,
FIG. 14 is a bottom view thereof.

The broken lines in the figures show portions of the retail fixture that form no part of the claimed design.

(56) **References Cited**

U.S. PATENT DOCUMENTS

D132,875 S 6/1942 Cooper
3,003,243 A 10/1961 Kanzelberger
D214,741 S 7/1969 Dean

(Continued)

1 Claim, 14 Drawing Sheets

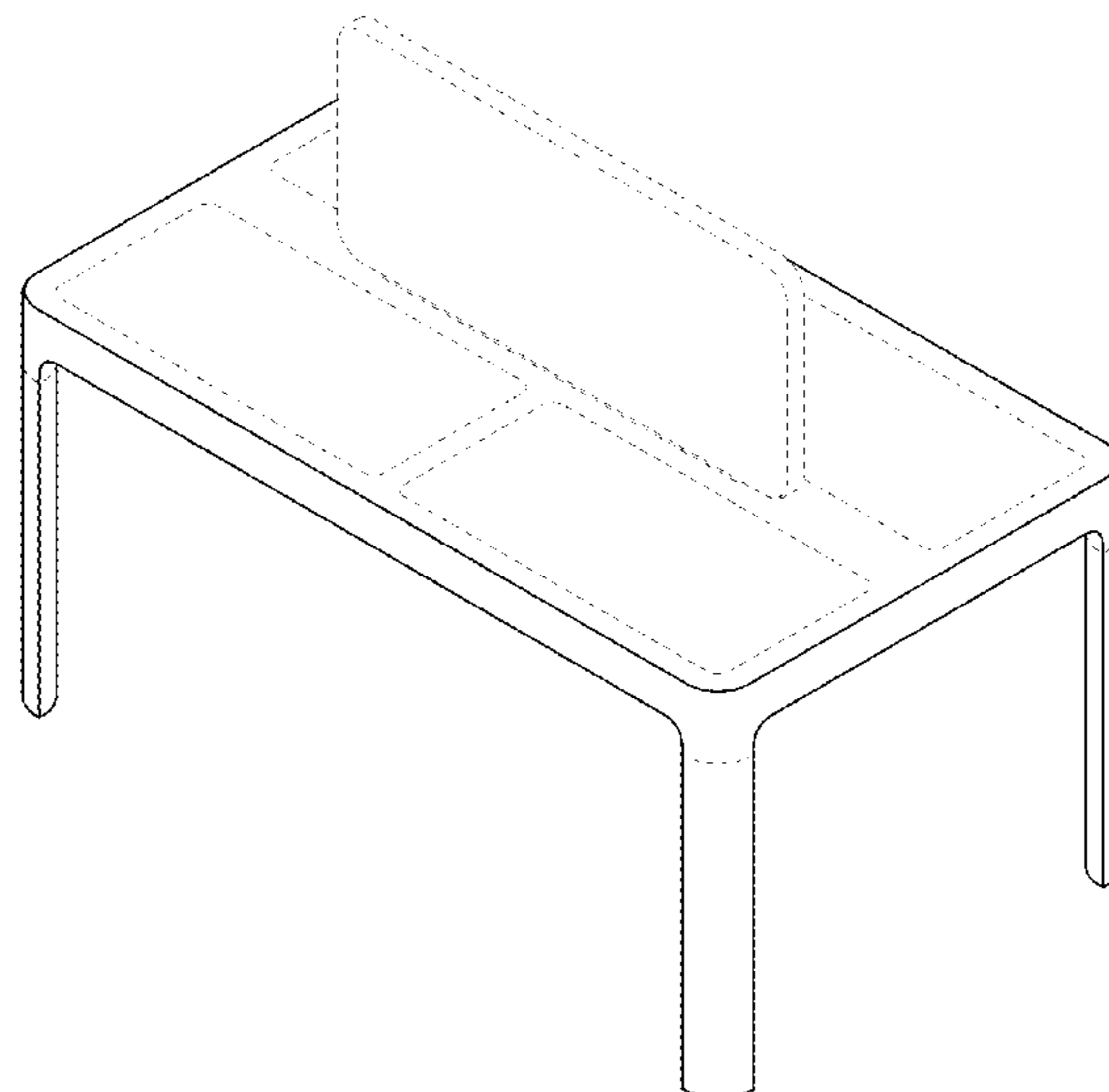

(58) **Field of Classification Search**
 CPC 21/0235; B65G 1/00; A47B 53/00; A47B
 53/02
 See application file for complete search history.

(56) **References Cited**

U.S. PATENT DOCUMENTS

D218,903 S 10/1970 Chichester
 D242,001 S 10/1976 Carter
 D243,376 S 2/1977 Scott
 D243,982 S 4/1977 Carter
 D248,351 S 7/1978 Bartholomew
 D264,289 S 5/1982 Klein
 D264,291 S 5/1982 Haigh
 D278,584 S 4/1985 Bromley
 D281,208 S 11/1985 Raftery
 4,765,253 A 8/1988 Schappach
 D299,893 S 2/1989 Diehl
 D300,889 S 5/1989 Bartlett
 D322,371 S 12/1991 Rosen
 D329,764 S 9/1992 Evans
 D350,661 S 9/1994 Klein
 D399,684 S 10/1998 Glass
 D407,245 S 3/1999 Lewis
 D424,841 S 5/2000 Newhouse
 D426,405 S 6/2000 Newhouse
 D447,892 S 9/2001 Shih
 D448,217 S 9/2001 Ullman
 D453,083 S 1/2002 Hokanson
 D459,621 S 7/2002 O'Hare et al.
 D468,562 S 1/2003 Chang
 D484,717 S 1/2004 de Blois
 D487,655 S 3/2004 Varsi
 D493,306 S 7/2004 Britschgi
 D503,298 S 3/2005 Juneau
 D513,676 S 1/2006 Vaaler
 D518,981 S 4/2006 O'Hare
 D522,274 S 6/2006 Coval
 D522,284 S 6/2006 Shapiro et al.
 D531,431 S 11/2006 Domack et al.
 D558,489 S 1/2008 Christensen
 D575,081 S 8/2008 Miyakawa
 D583,590 S 12/2008 Ellouz
 D585,218 S 1/2009 Hamilton et al.
 D590,185 S 4/2009 Karashima
 D591,079 S 4/2009 Singler et al.
 D591,979 S 5/2009 Singler et al.
 D604,063 S 11/2009 Oshinomi et al.
 D613,968 S 4/2010 Lambert
 D620,288 S 7/2010 Stiker Metral
 D646,507 S 10/2011 Delmestri
 D647,333 S 10/2011 Navone
 D649,380 S 11/2011 Townsend
 D649,381 S 11/2011 Mainzer
 D655,949 S 3/2012 Villiers et al.
 D657,978 S 4/2012 Hamm et al.
 D659,433 S 5/2012 Starck
 D661,129 S 6/2012 Schweikarth et al.
 D670,104 S 11/2012 Li et al.
 D674,625 S 1/2013 Mecherle et al.
 D675,462 S 2/2013 Petrovich
 D678,696 S 3/2013 Hamm et al.
 D679,521 S 4/2013 Hamm et al.
 D683,161 S 5/2013 Polloni
 D684,413 S 6/2013 Schmitt
 D688,494 S 8/2013 Hamm et al.
 D689,307 S 9/2013 Burt
 D693,156 S 11/2013 Hamm et al.
 D713,658 S 9/2014 Tio et al.
 D717,572 S 11/2014 Morrison
 D725,947 S 4/2015 Tio et al.
 D726,460 S 4/2015 Arnon et al.
 D728,281 S 5/2015 Heirakuji et al.
 D729,560 S 5/2015 Hamm et al.
 D734,078 S 7/2015 Bougay
 D734,965 S 7/2015 Tio et al.

D736,017 S 8/2015 Rose
 D746,616 S 1/2016 Akana et al.
 D753,419 S 4/2016 Heirakuji et al.
 D757,464 S 5/2016 Chiang
 D758,106 S 6/2016 Hamm et al.
 D766,630 S 9/2016 Akana et al.
 D766,631 S 9/2016 Akana et al.
 D766,632 S 9/2016 Akana et al.
 D766,633 S 9/2016 Akana et al.
 D767,310 S 9/2016 Akana et al.
 D769,654 S 10/2016 Akana et al.
 D773,868 S 12/2016 Schwalbach et al.
 D776,471 S 1/2017 Mandon et al.
 D779,244 S 2/2017 Akana et al.
 D780,491 S 3/2017 Magargee et al.
 D781,086 S 3/2017 Velez et al.
 D783,324 S 4/2017 Akana et al.
 9,635,931 B2 * 5/2017 Mandon A47B 21/06
 D788,506 S 6/2017 Choi
 D790,262 S 6/2017 Akana et al.
 D799,250 S 10/2017 Schwalbach et al.
 D799,866 S 10/2017 Pocci et al.
 D810,476 S 2/2018 Heirakuji et al.
 D810,482 S 2/2018 Modlin
 D815,474 S 4/2018 Modlin
 D833,789 S 11/2018 Schwalbach et al.
 D837,578 S 1/2019 Rundle
 D855,358 S 8/2019 Adler et al.
 D865,413 S 11/2019 Chapuis et al.
 D865,419 S 11/2019 Chavarria
 D867,035 S 11/2019 Brugger et al.
 D873,056 S * 1/2020 Stafford D6/675
 D877,547 S * 3/2020 Dejesus D6/675
 2005/0268823 A1 12/2005 Bakker et al.
 2006/0096506 A1 5/2006 Brauning et al.
 2009/0095204 A1 4/2009 Levy et al.
 2009/0165679 A1 * 7/2009 Bakker A47B 21/06
 108/50.02
 2010/0290215 A1 11/2010 Metcalf et al.
 2011/0297052 A1 * 12/2011 Martin A47B 13/021
 108/27
 2013/0081559 A1 * 4/2013 Roh A47B 21/06
 108/50.02
 2014/0124641 A1 5/2014 Kassanoff et al.
 2015/0150370 A1 6/2015 Korb et al.
 2016/0064995 A1 3/2016 Schwalbach et al.
 2016/0255957 A1 9/2016 Tsuchiyama et al.
 2017/0051771 A1 2/2017 Feinstein

FOREIGN PATENT DOCUMENTS

KR 167611 8/1995
 WO WO DM-074057 10/2010
 WO DM/078433 6/2012

OTHER PUBLICATIONS

Japanese Patent Office Document HB06003569, dated by JPO Oct. 31, 1993.
 Japanese Patent Office Document HA14019873, dated by JPO Dec. 1, 2012.
 Japanese Patent Office Document HA24006766, dated by JPO Sep. 1, 2012.
 Japanese Patent Office Document HC13007386.
 Neil Hughes, "Apple retail stores 'bulging at the seams' at 8400 average square feet," Appleinsider.com, dated May 8, 2012, accessed at <http://appleinsider.com/articles/12/05/08/apple_retail_stores_bulging_at_the_seams_at_8400_average_square_feet> 2 pages.
 Valentina Palladino, "Apple Store Receives Trademark for 'Distinctive Design and Layout,'" Wired.com, dated Jan. 30, 2013, accessed at <<http://www.wired.com/2013/01/apple-store-trademark/>> 2 pages.
 "Apple Granted 8 Design Patents for All-New Apple Watch Tables," Patently Apple, Nov. 28, 2015. Retrieved from the Internet: <<http://>

(56)

References Cited

OTHER PUBLICATIONS

www.patentlyapple.com/patently-apple/2015/11/apple-granted-8-design-patents-for-all-new-apple-watch-tables.html, 6 pages.

* cited by examiner

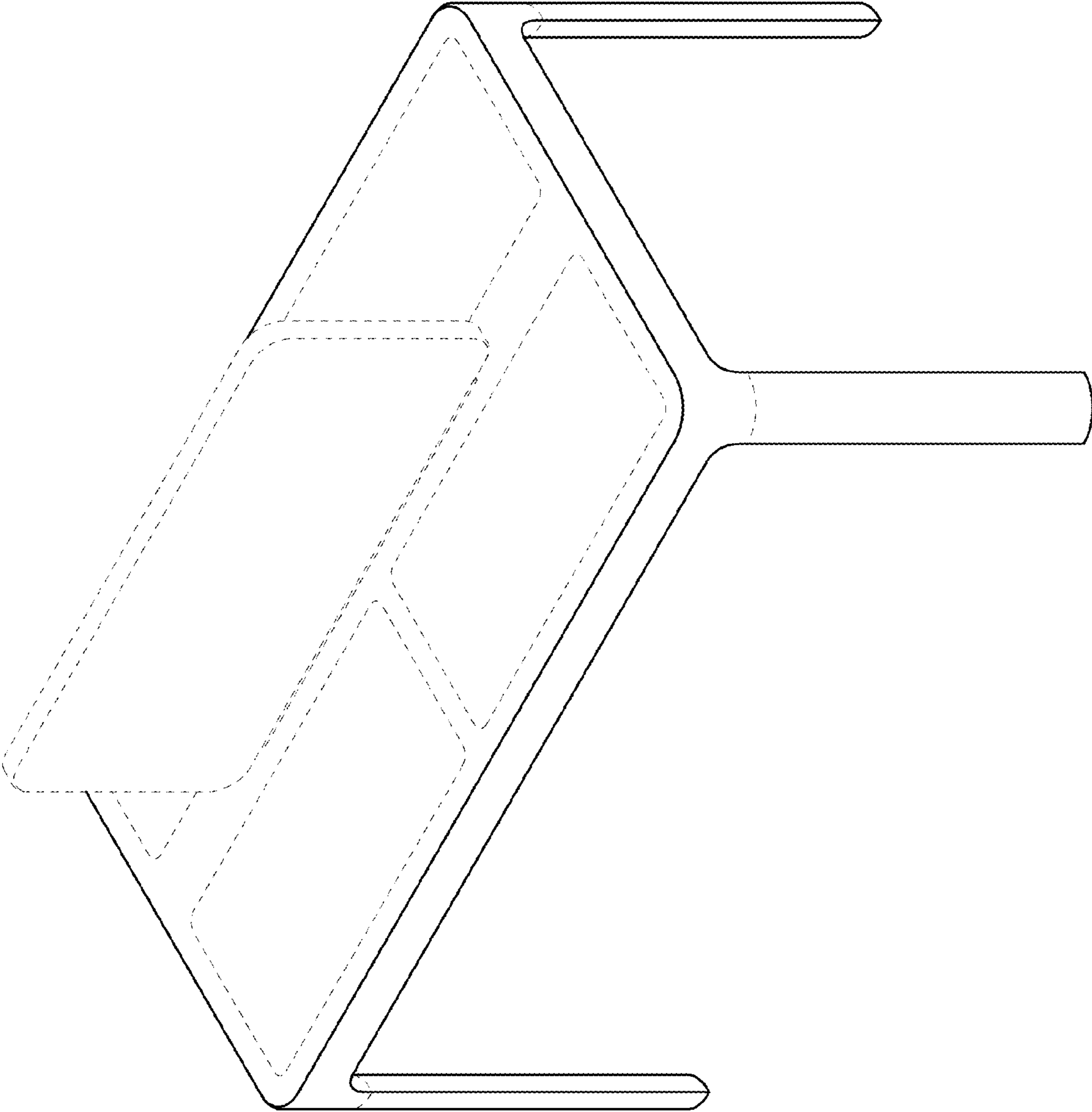

FIG. 1

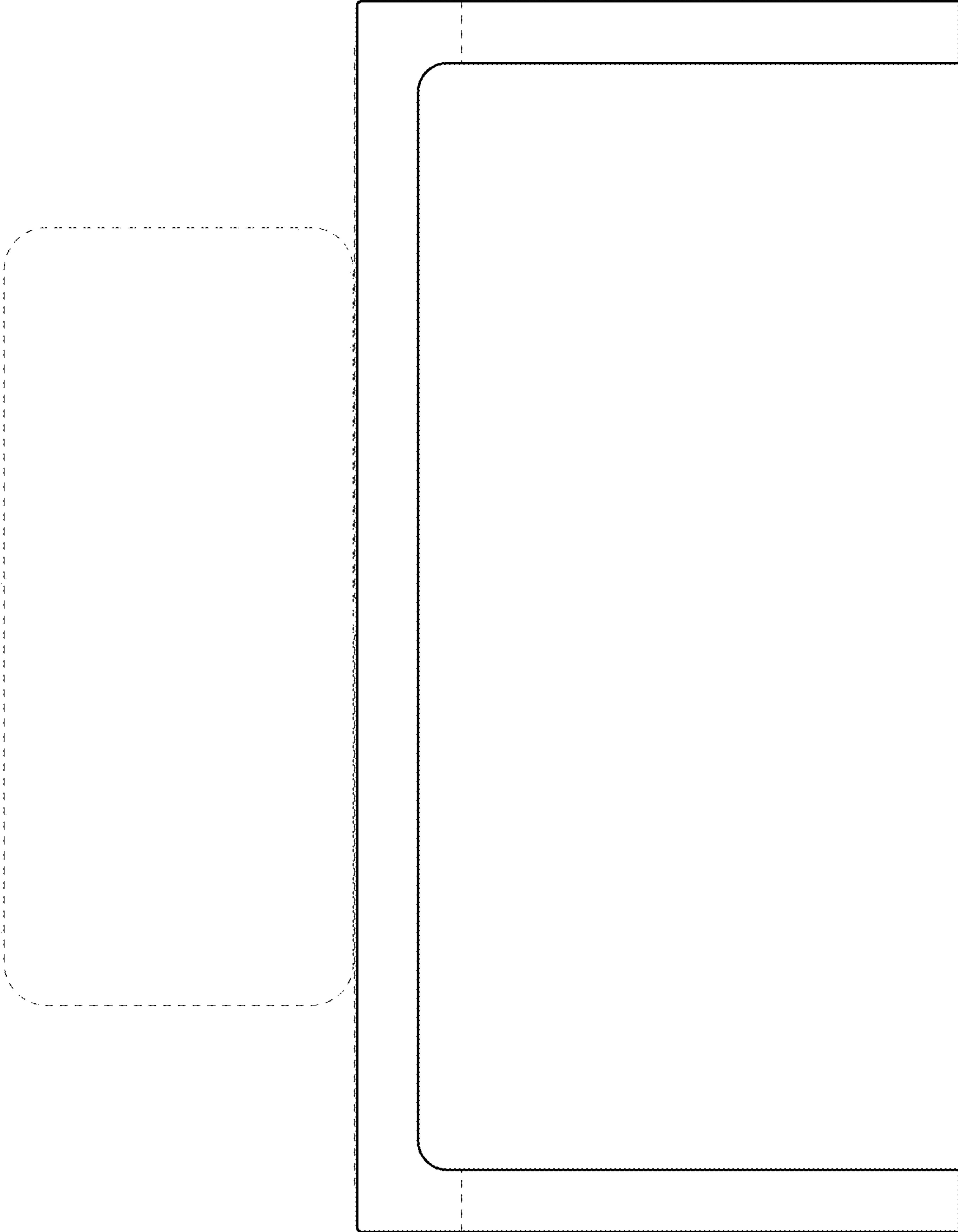

FIG. 2

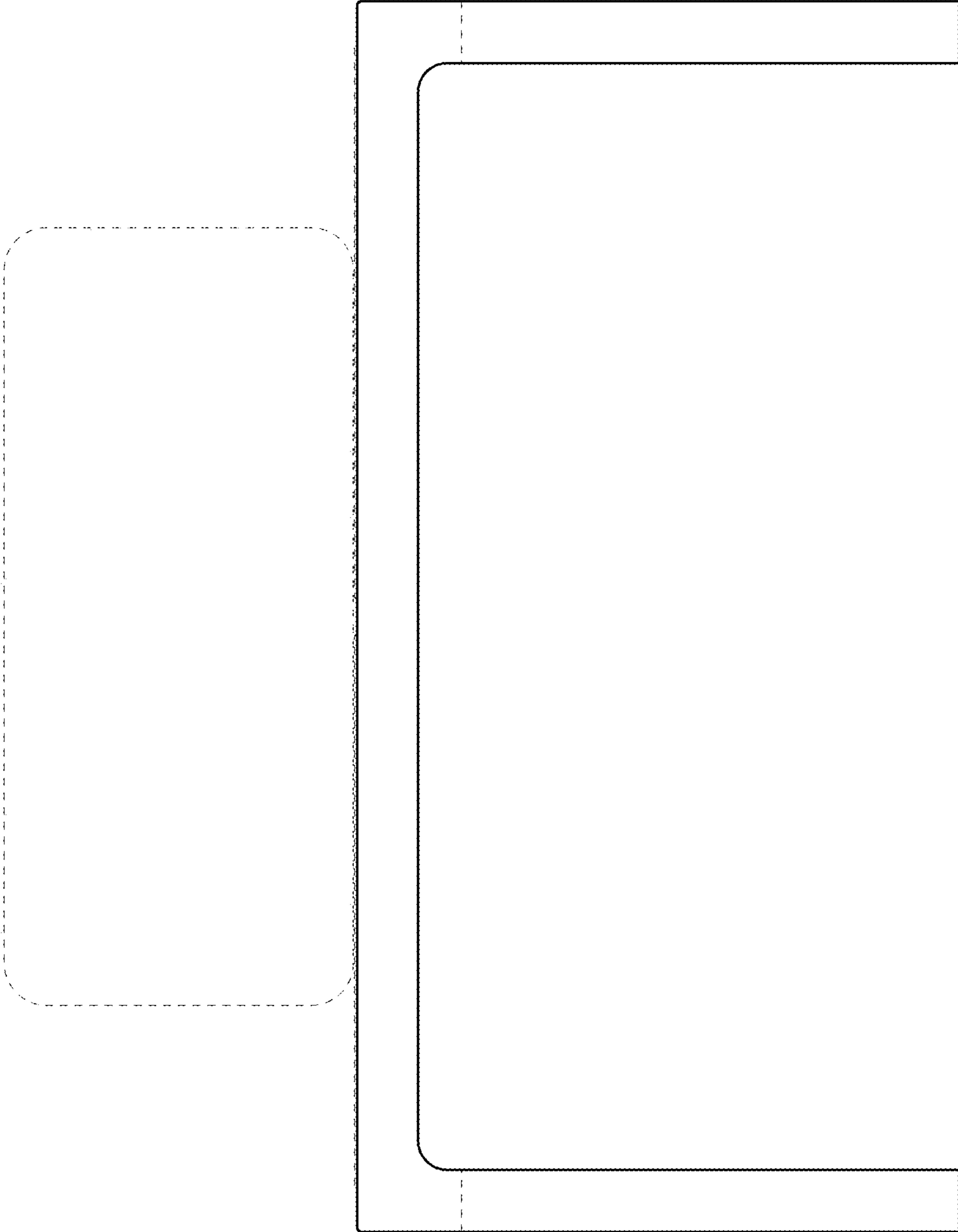

FIG. 3

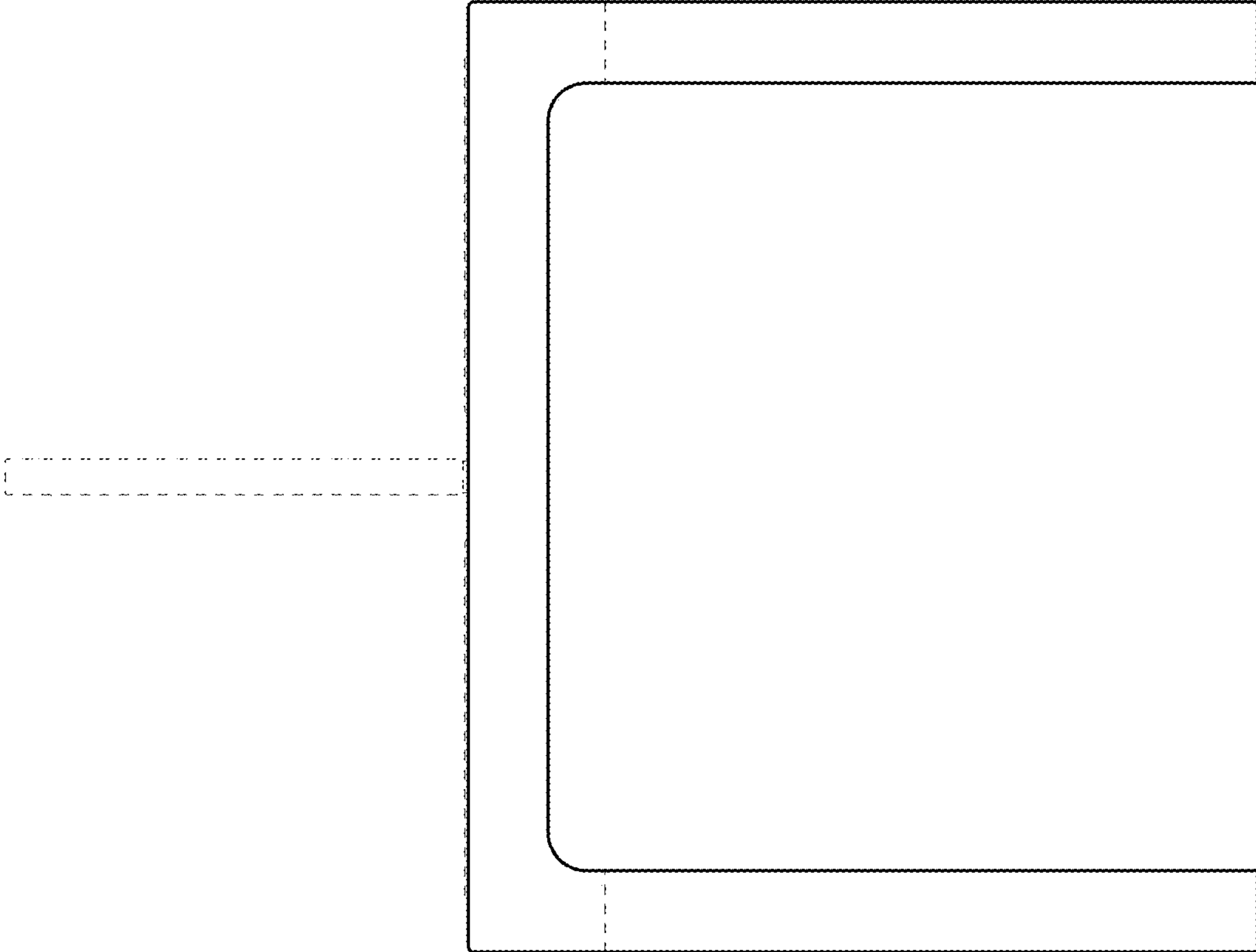

FIG. 4

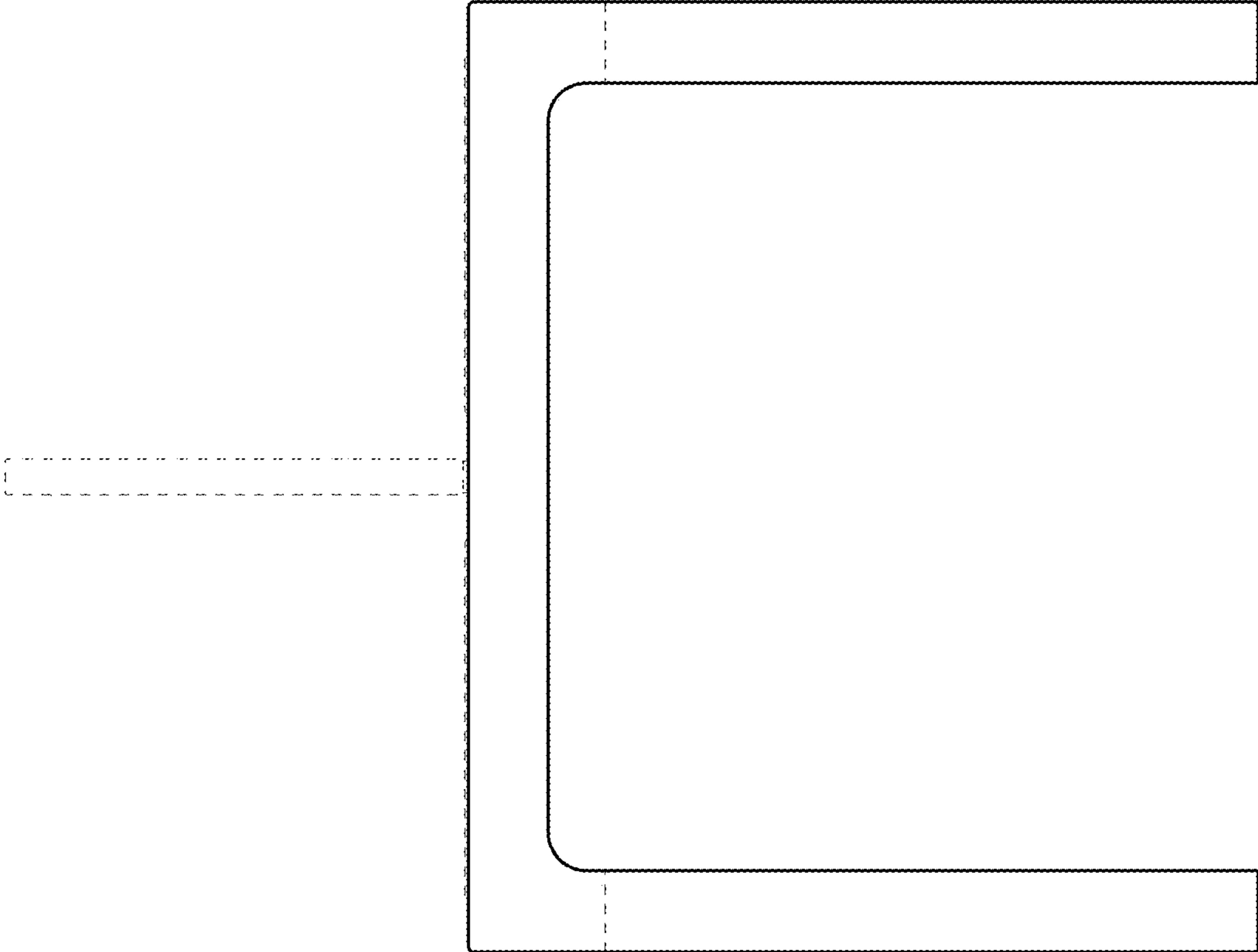

FIG. 5

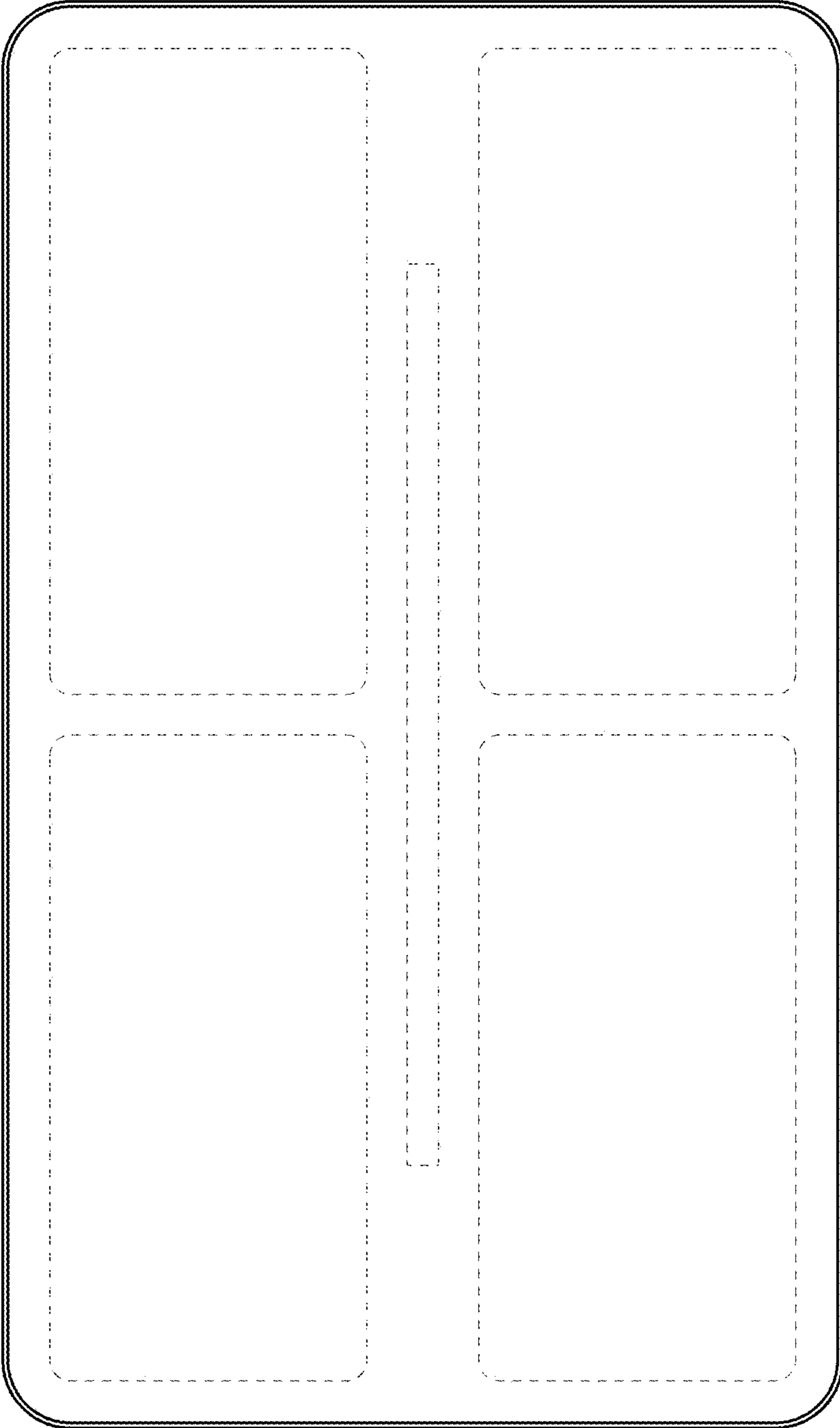

FIG. 6

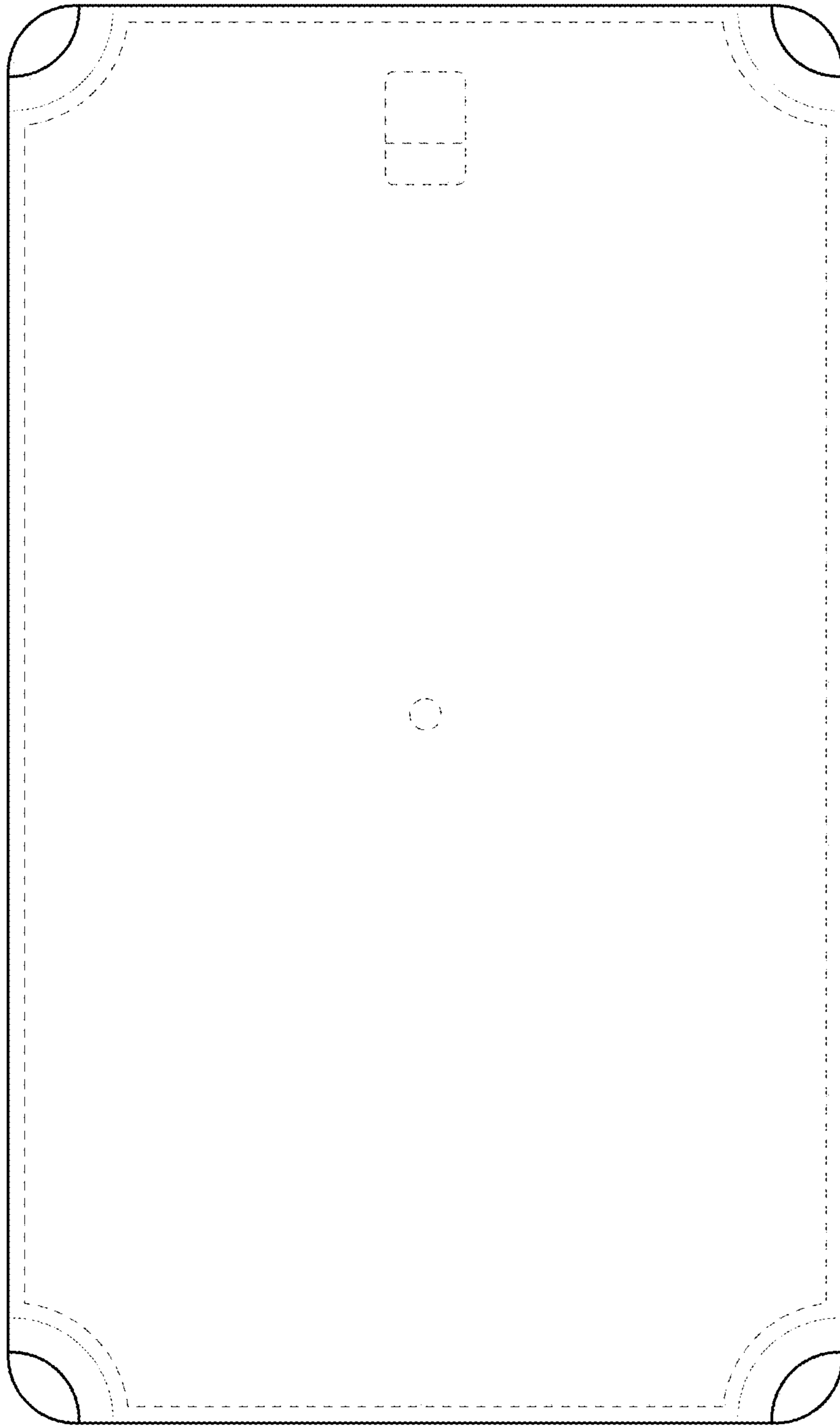

FIG. 7

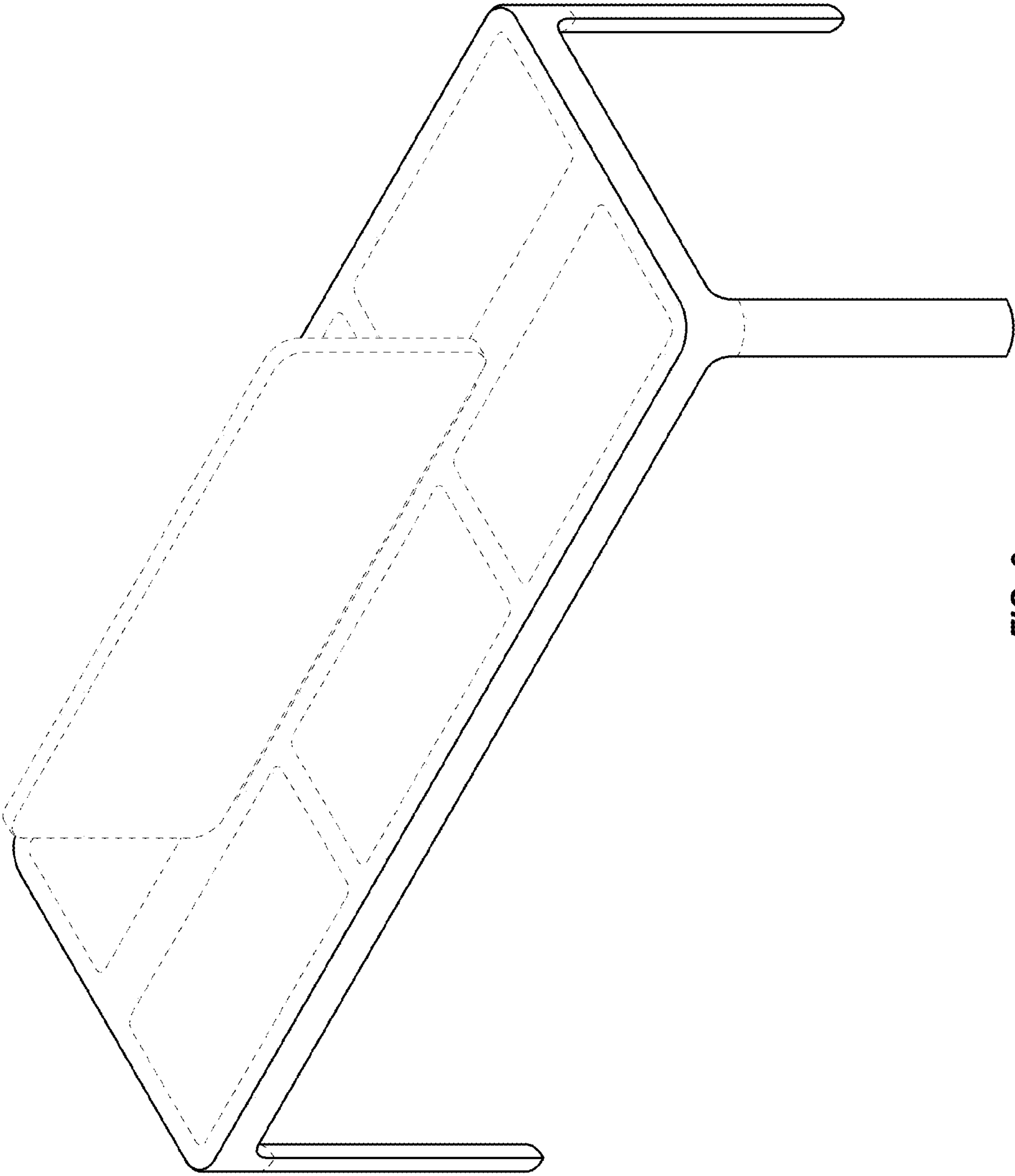

FIG. 8

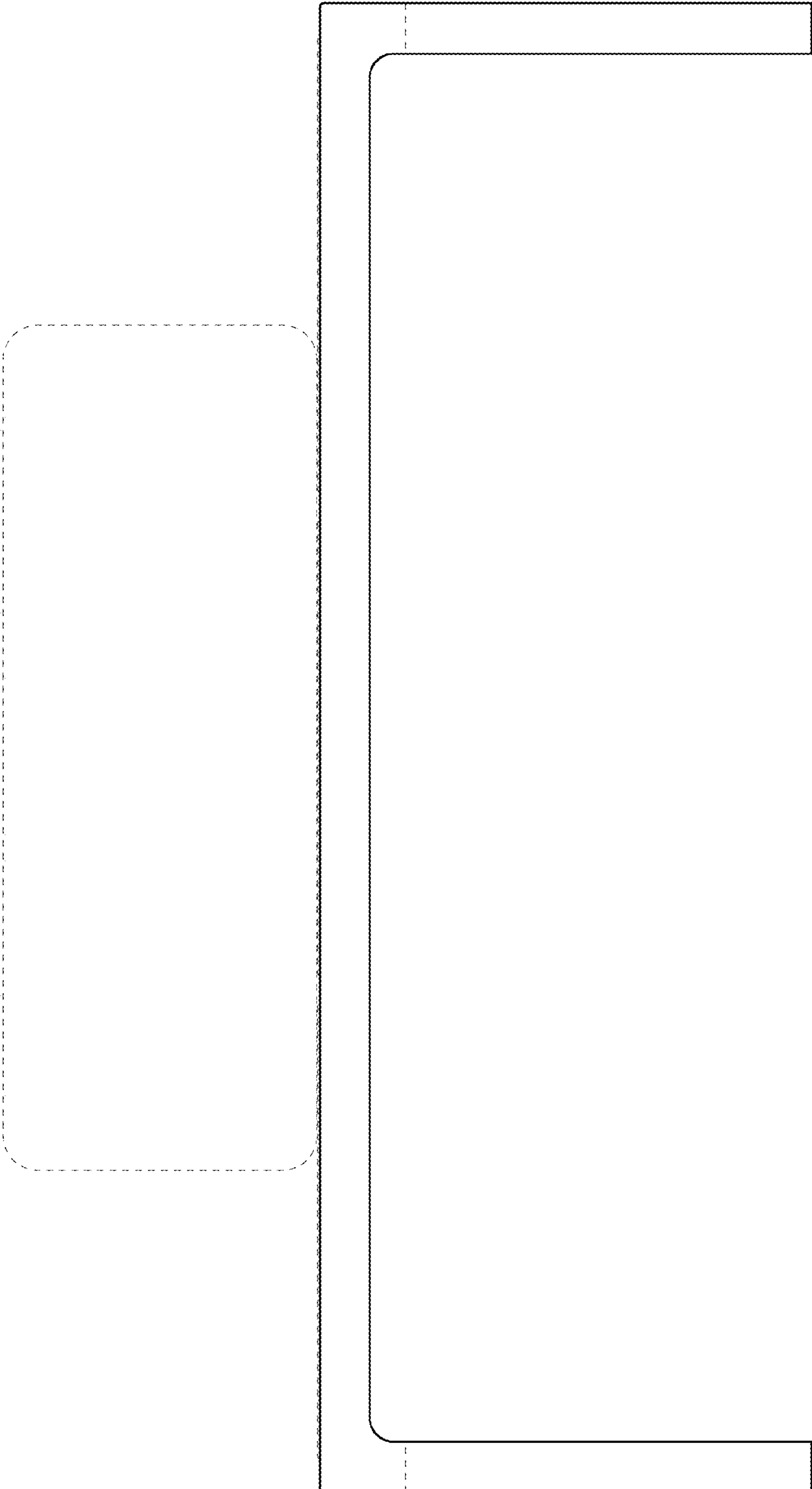

FIG. 9

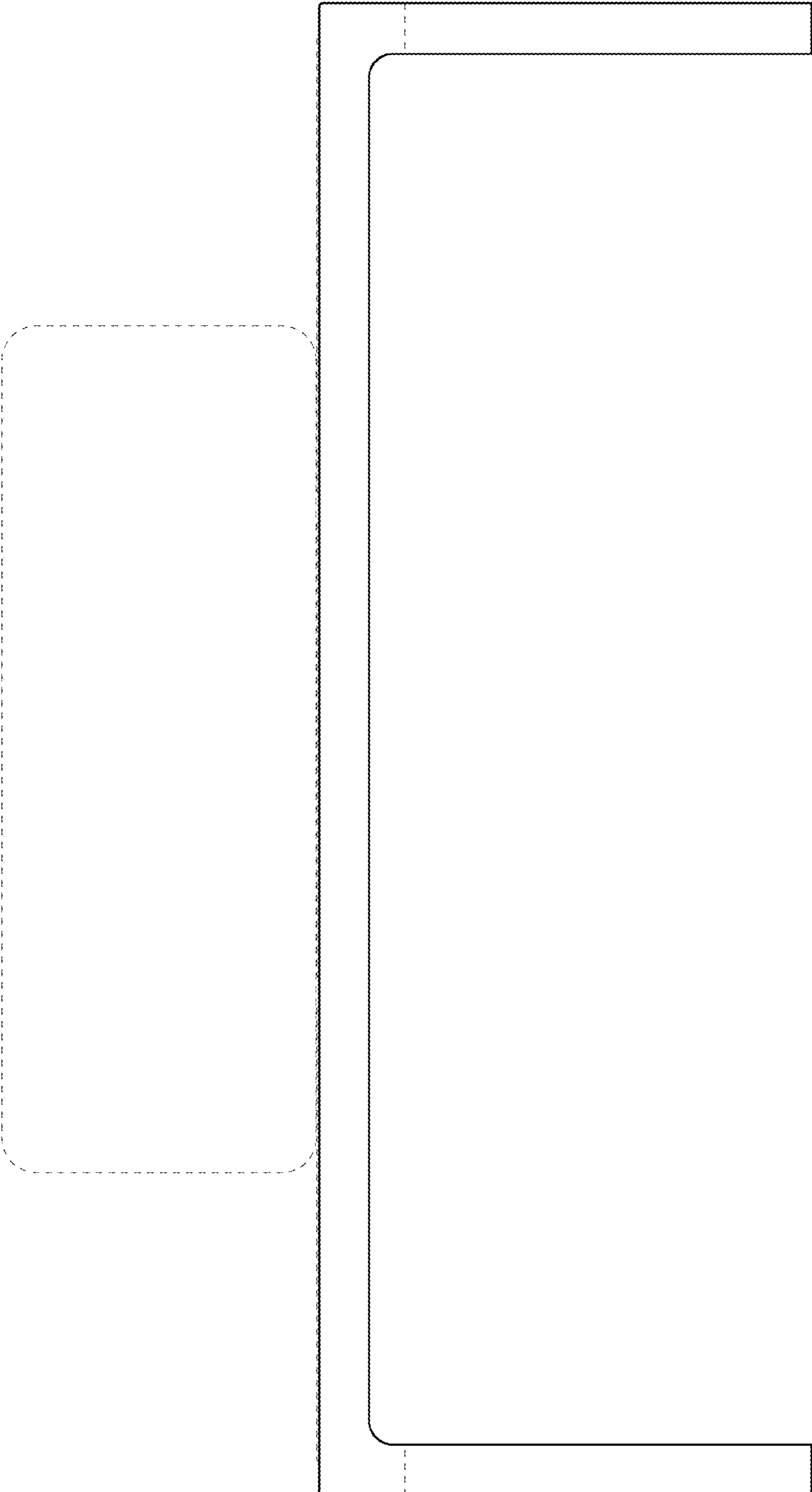

FIG. 10

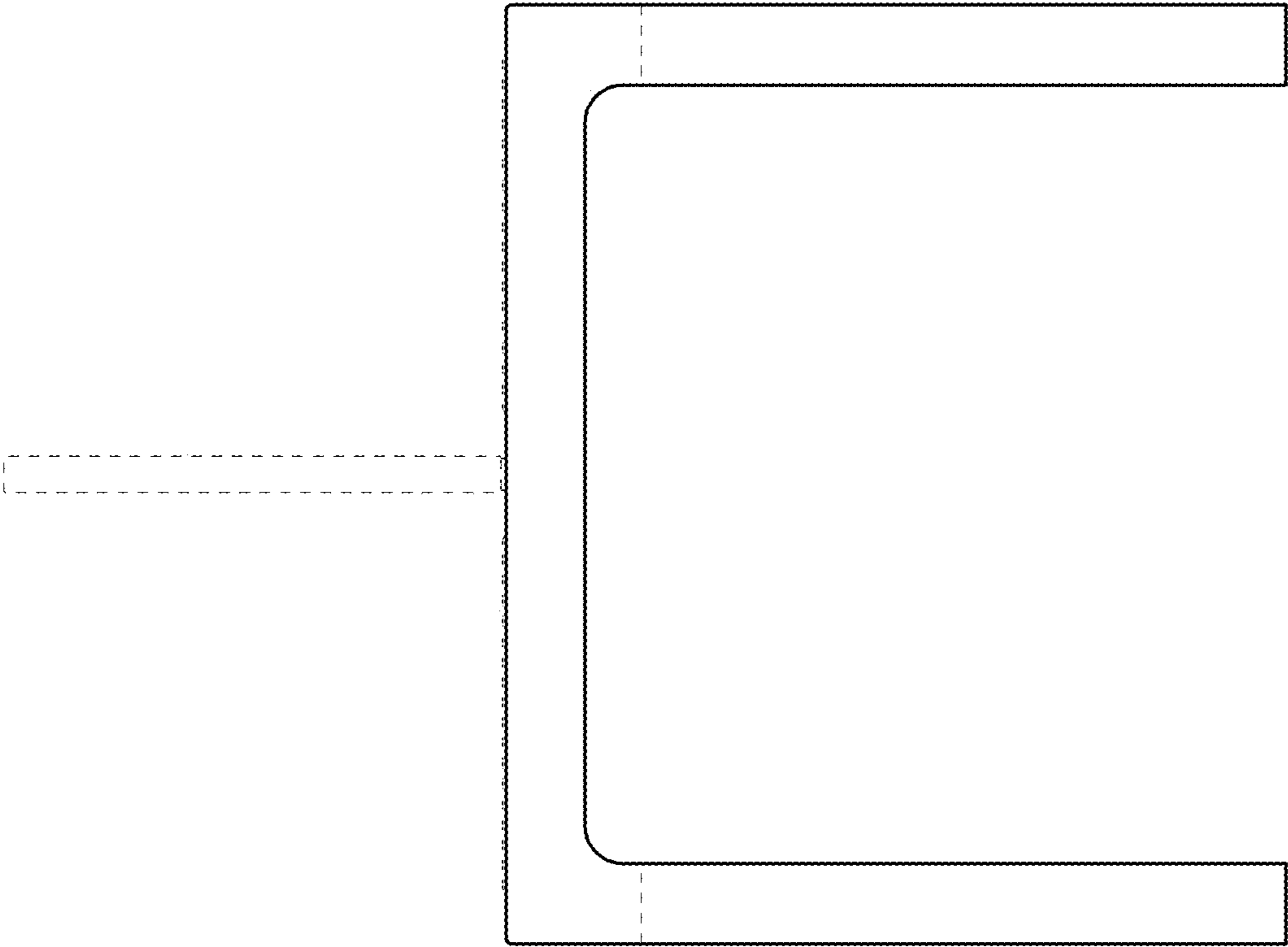

FIG. 11

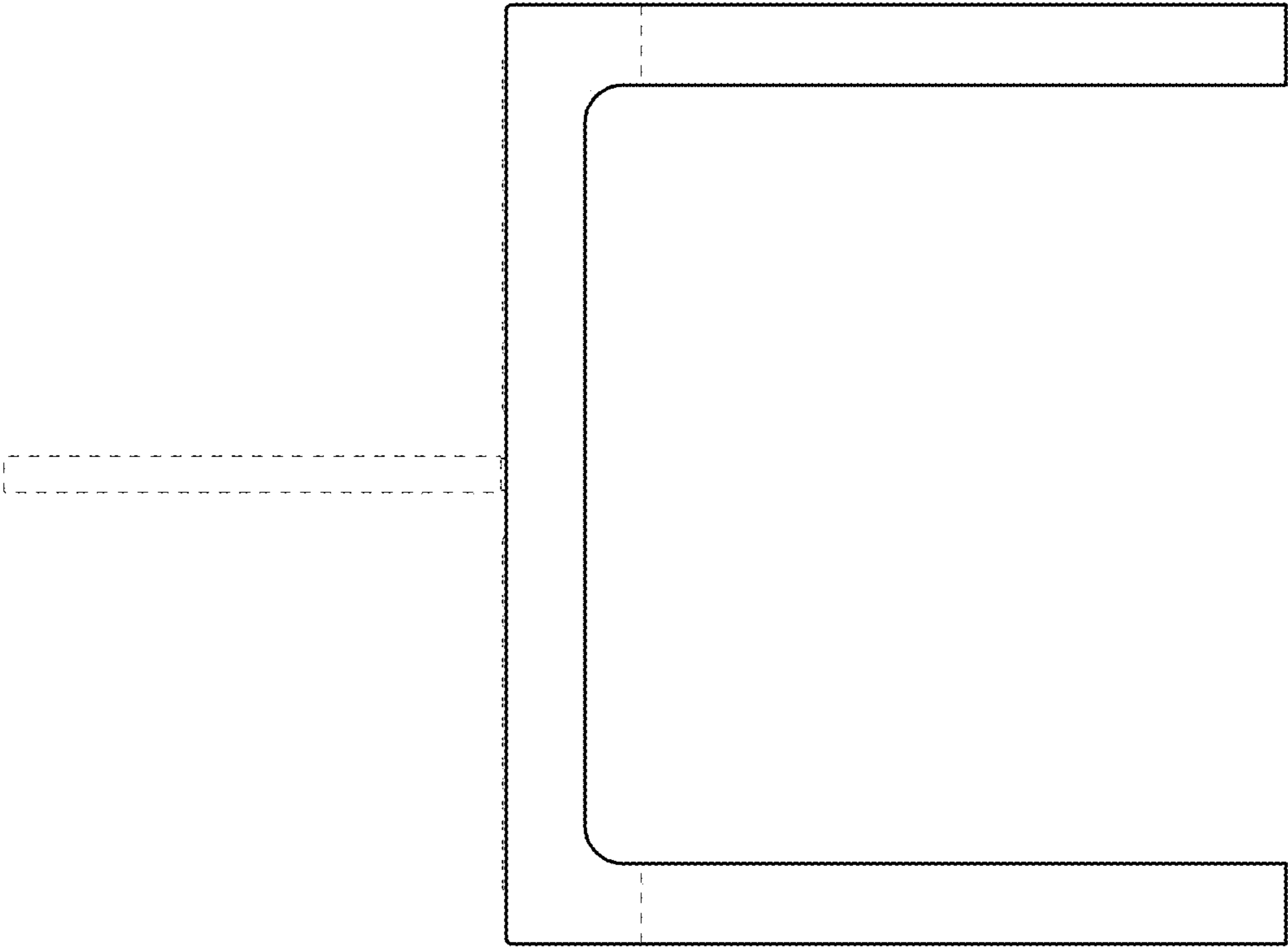

FIG. 12

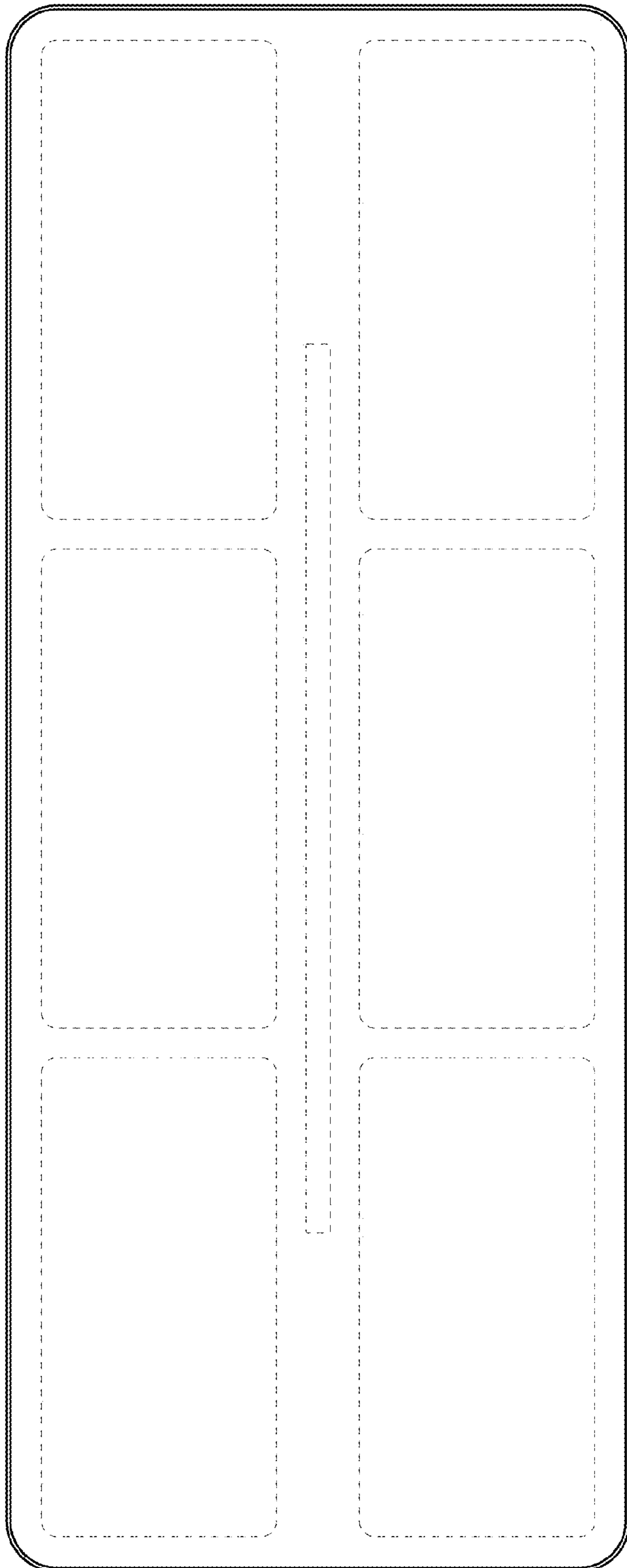

FIG. 13

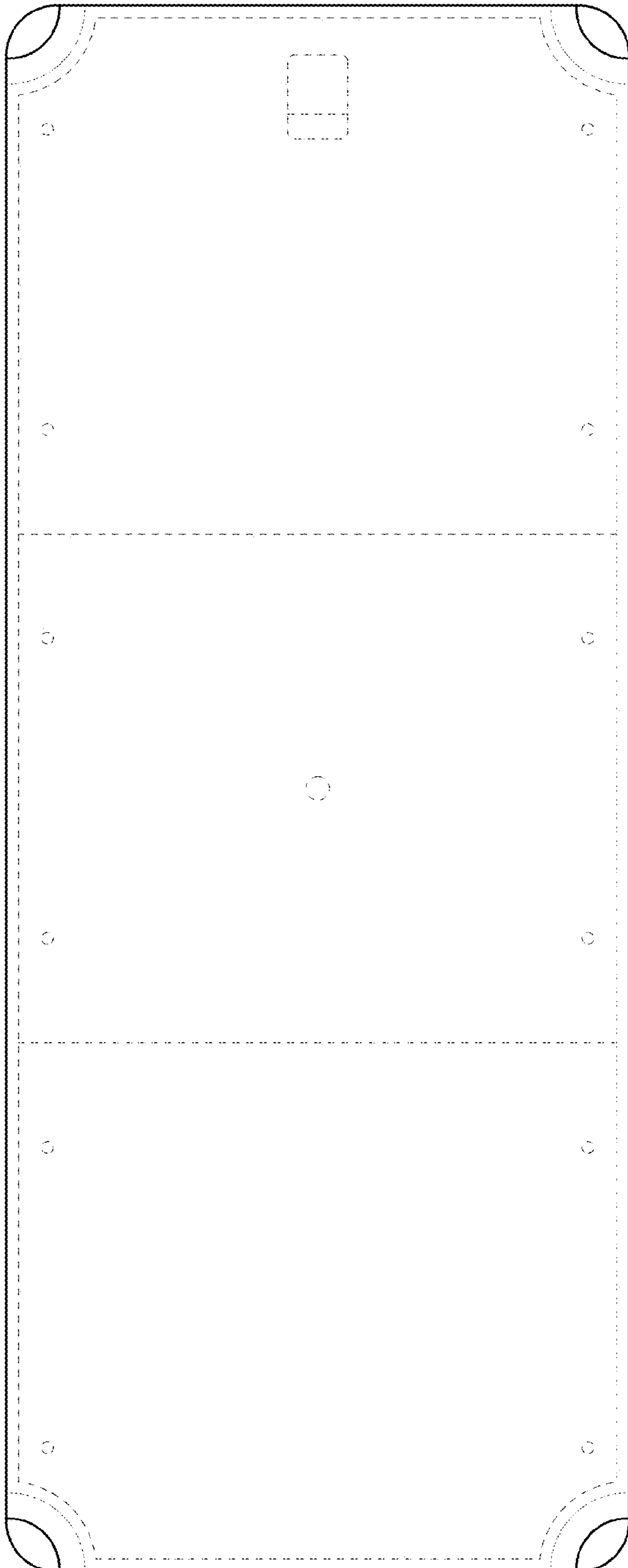

FIG. 14