



US00D893872S

(12) **United States Design Patent** (10) **Patent No.:** **US D893,872 S**
Vieyra et al. (45) **Date of Patent:** **** Aug. 25, 2020**

(54) **PROTECTED WEARABLES CARRIER**

D828,032 S * 9/2018 Brundage D3/303
D867,757 S * 11/2019 Justiss D3/247

(71) Applicant: **VIEYRA INC.**, Houston, TX (US)

* cited by examiner

(72) Inventors: **Fortune Vieyra**, Houston, TX (US);
Jamie Ibanez, Houston, TX (US)

Primary Examiner — Catherine R Oliver-Garcia
(74) *Attorney, Agent, or Firm* — Volpe and Koenig, P.C.

(73) Assignee: **VIEYRA INC**, Houston, TX (US)

(57) **CLAIM**

(**) Term: **15 Years**

The ornamental design for a protected wearables carrier, as shown and described.

(21) Appl. No.: **29/635,062**

DESCRIPTION

(22) Filed: **Jan. 26, 2018**

FIG. 1 is a perspective view of a first embodiment of a protected wearables carrier in accordance with our new design;

(51) **LOC (12) Cl.** **03-01**

FIG. 2 is a front view thereof;

(52) **U.S. Cl.**

FIG. 3 is a rear view thereof;

USPC **D3/303**; D3/226

FIG. 4 is a side view thereof;

(58) **Field of Classification Search**

FIG. 5 is an opposite side view thereof;

USPC D3/215, 224, 226, 221, 232–234, 245,
D3/247–252, 269, 301; 224/191, 195,
224/240–241, 245, 251, 274, 664, 669,
224/676–677, 682; 150/100, 103–104,
150/114, 131, 152; 383/63, 111, 113

FIG. 6 is a top view thereof;

CPC A47C 7/62; A47C 1/14; A45C 1/06; A45C
3/08

FIG. 7 is a bottom view thereof;

See application file for complete search history.

FIG. 8 is a perspective view of the first embodiment shown in use;

(56) **References Cited**

U.S. PATENT DOCUMENTS

D421,526 S * 3/2000 Isaacson D3/303
D429,497 S * 8/2000 Wyant D3/303
D669,682 S * 10/2012 Crifasi D3/226
D671,738 S * 12/2012 Hargens D3/226
D719,732 S * 12/2014 Hyzdu D3/303

FIG. 9 is a front view of a second embodiment of a protected wearables carrier shown in use;

FIG. 10 is a rear view thereof;

FIG. 11 is a perspective view of a third embodiment of a protected wearables carrier in accordance with the new design shown in use;

FIG. 12 is a top view thereof;

FIG. 13 is a bottom view thereof;

FIG. 14 is a side view thereof; and,

FIG. 15 is an opposite side view thereof.

The bottom view of the second embodiment is plain an unornamented as shown in the bottom view of the first embodiment.

The bottom view of the second embodiment is plain an unornamented as shown in the bottom view of the first embodiment.

The bottom view of the second embodiment is plain an unornamented as shown in the bottom view of the first embodiment.

The bottom view of the second embodiment is plain an unornamented as shown in the bottom view of the first embodiment.

The bottom view of the second embodiment is plain an unornamented as shown in the bottom view of the first embodiment.

The bottom view of the second embodiment is plain an unornamented as shown in the bottom view of the first embodiment.

The bottom view of the second embodiment is plain an unornamented as shown in the bottom view of the first embodiment.

The bottom view of the second embodiment is plain an unornamented as shown in the bottom view of the first embodiment.

The bottom view of the second embodiment is plain an unornamented as shown in the bottom view of the first embodiment.

1 Claim, 11 Drawing Sheets

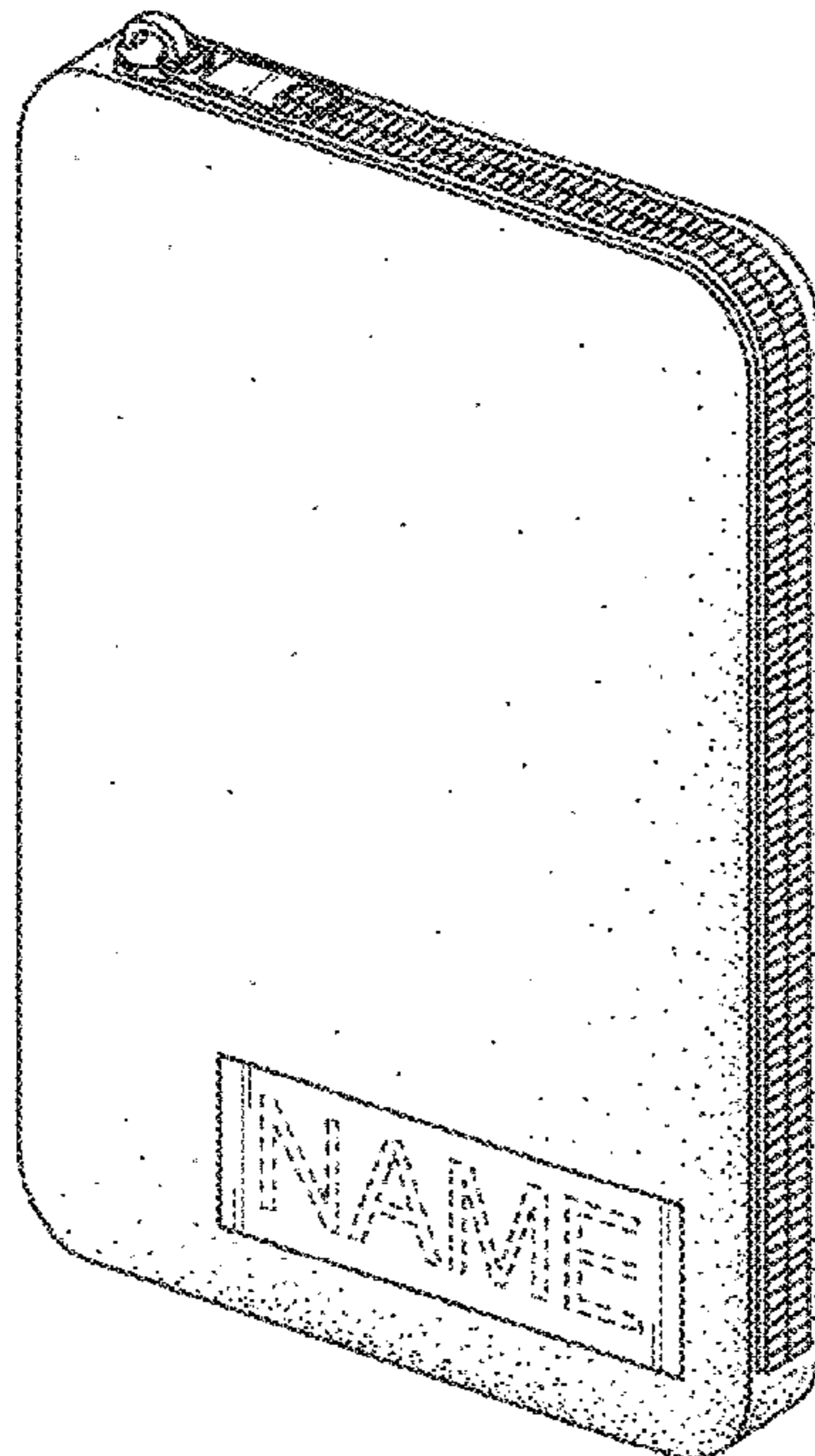

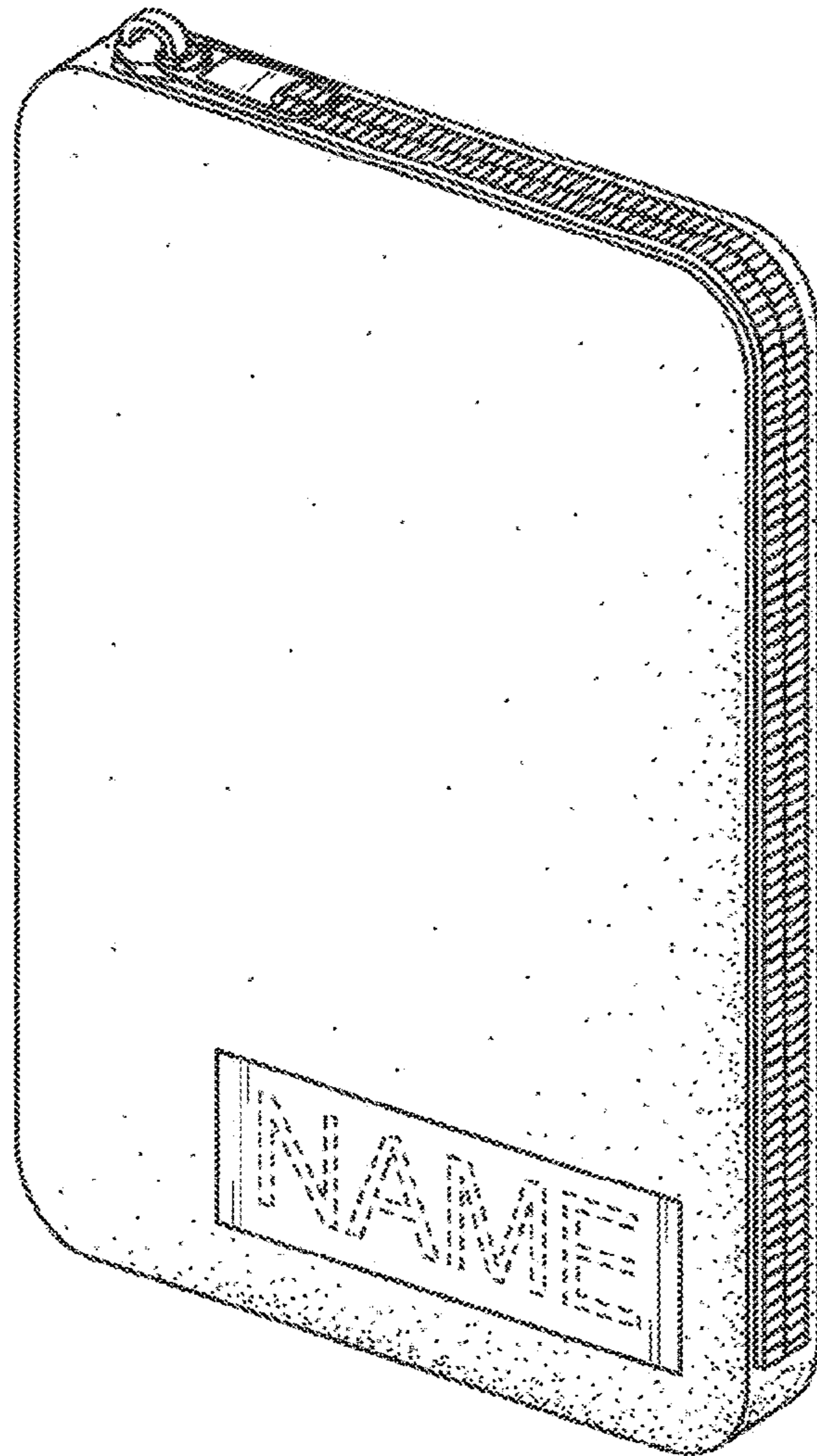

FIG. 1

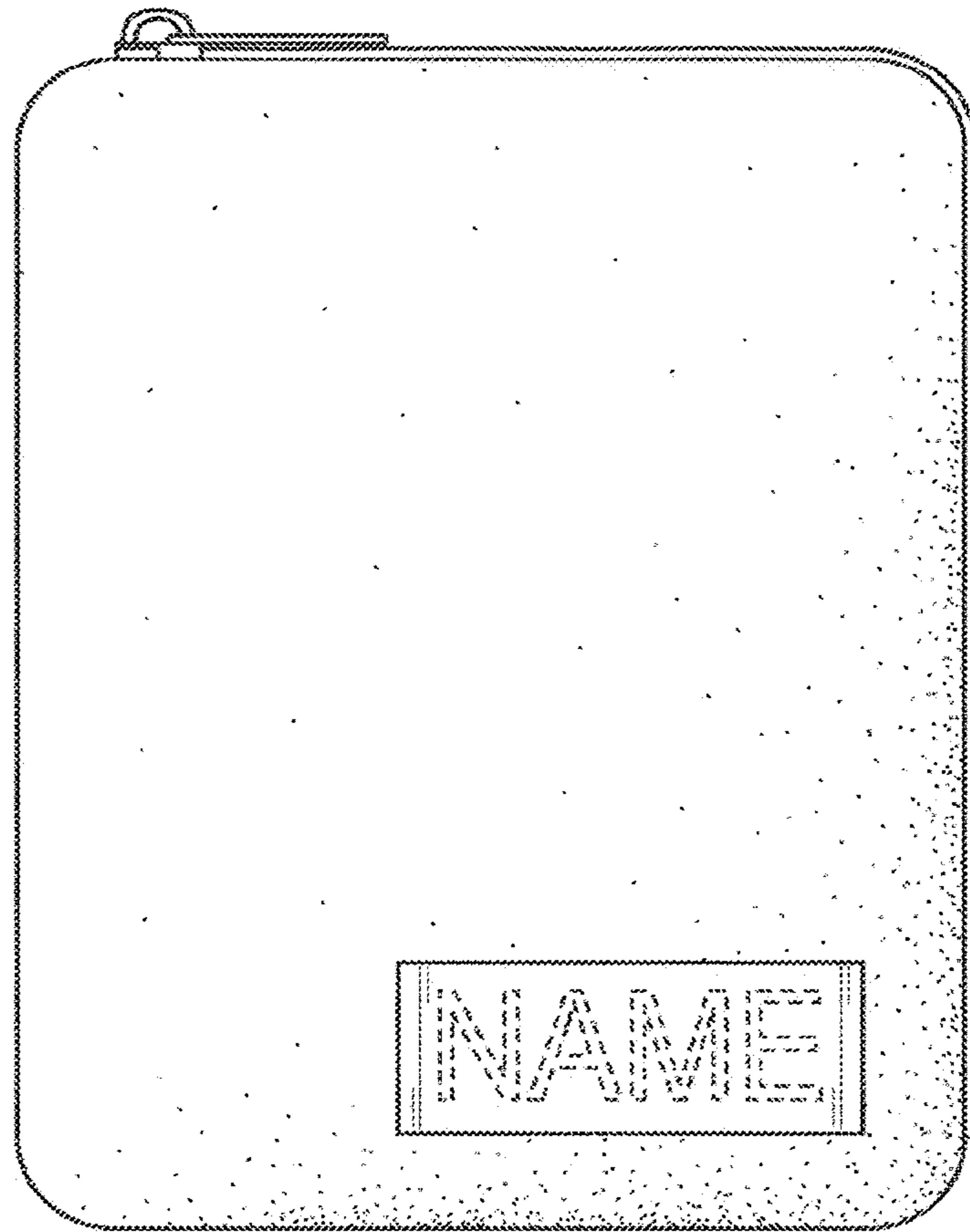

FIG. 2

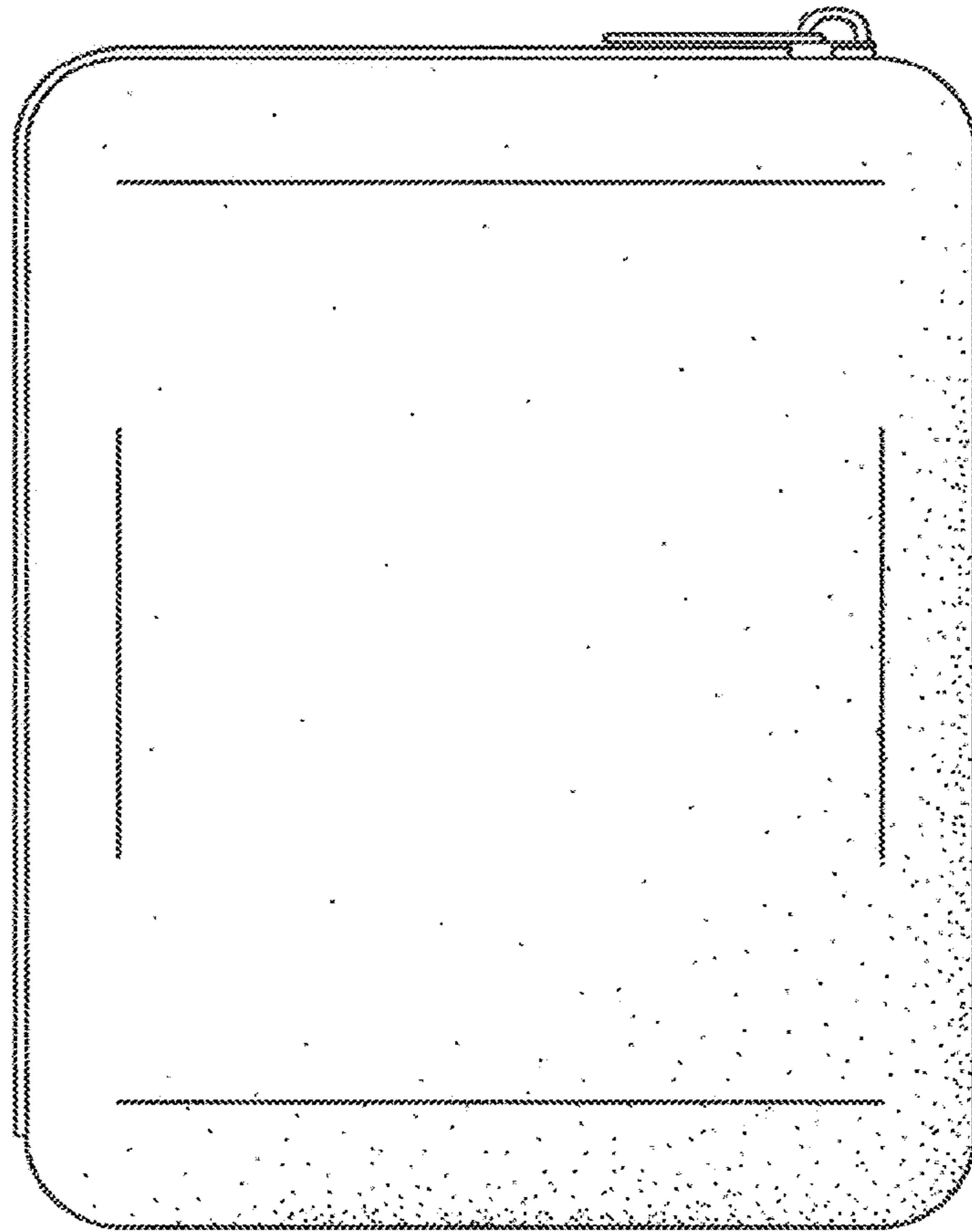

FIG. 3

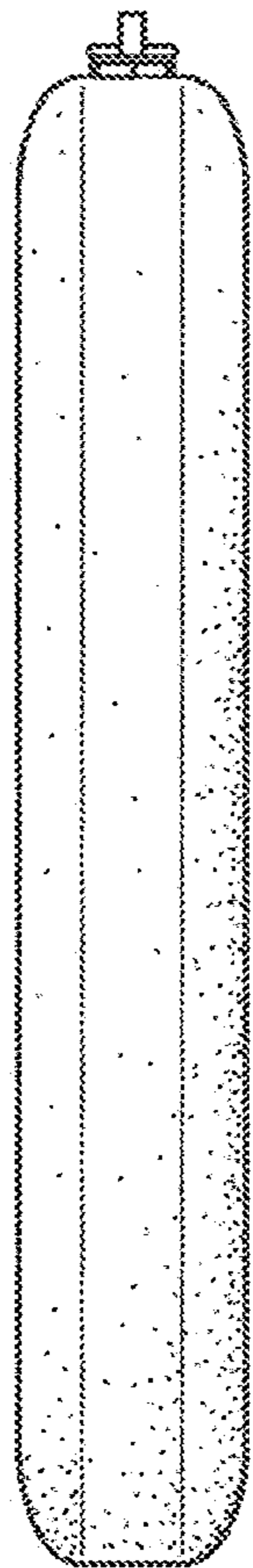

FIG. 4

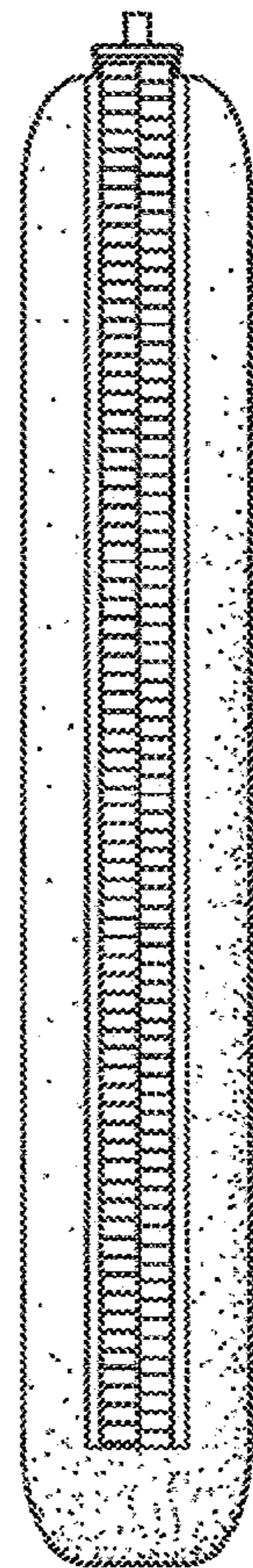

FIG. 5

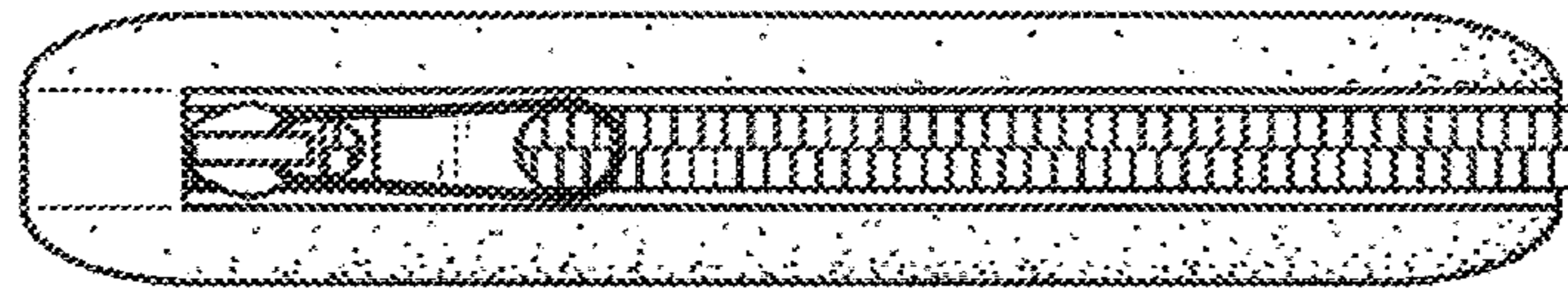

FIG. 6

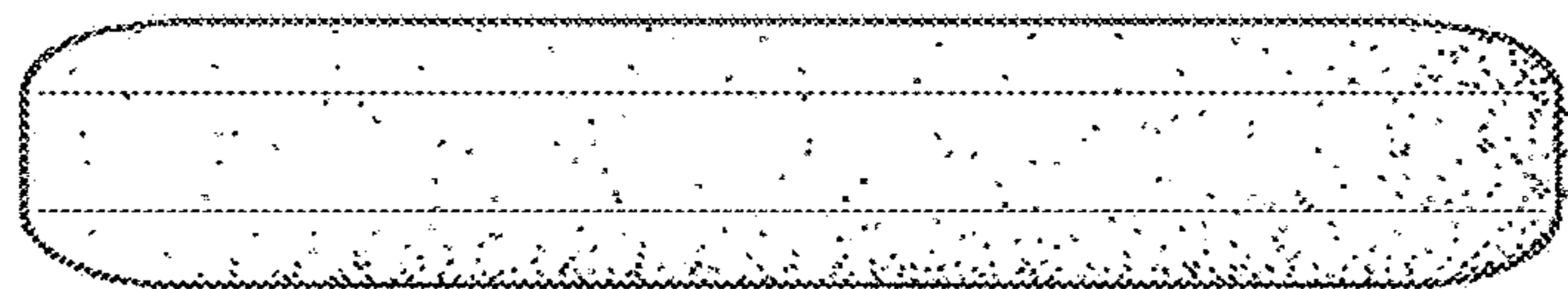

FIG. 7

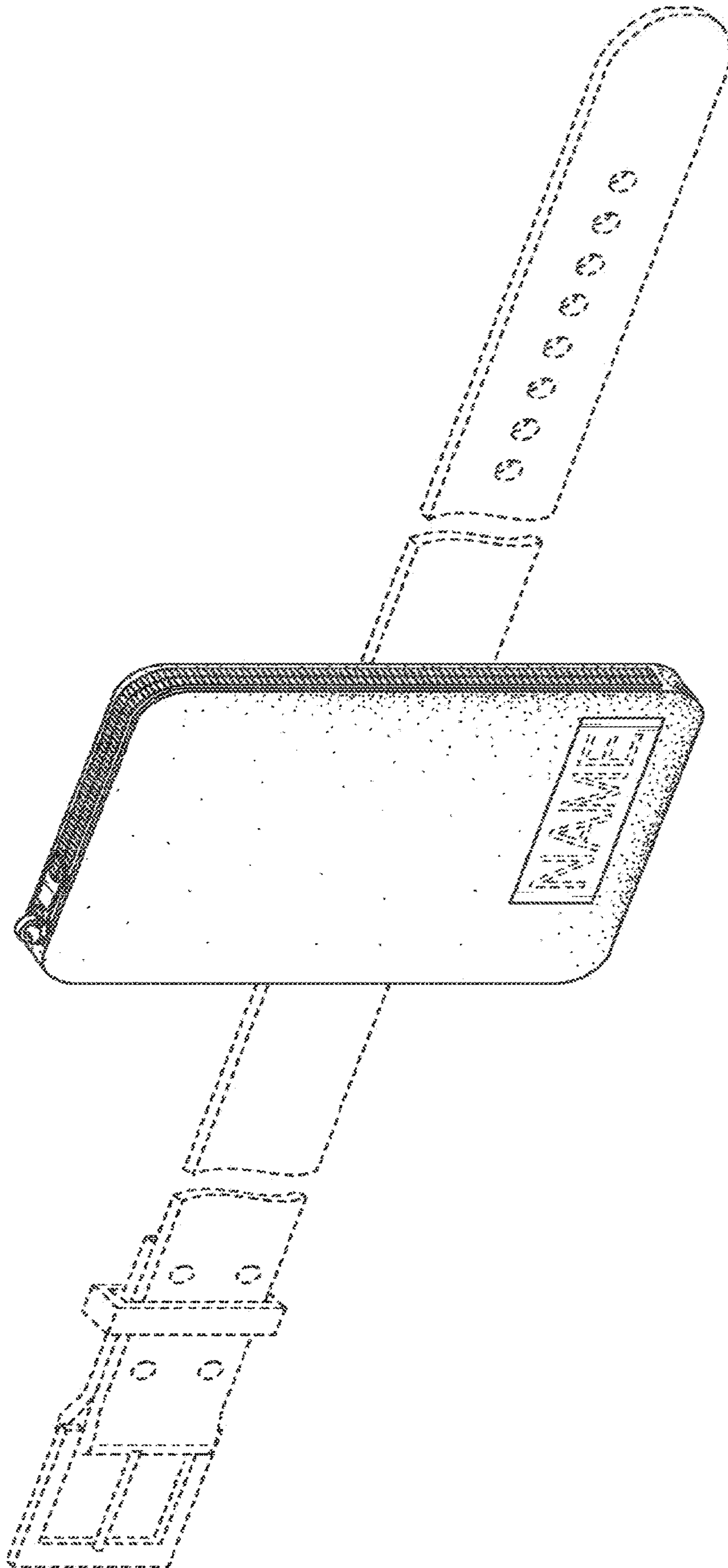

FIG. 8

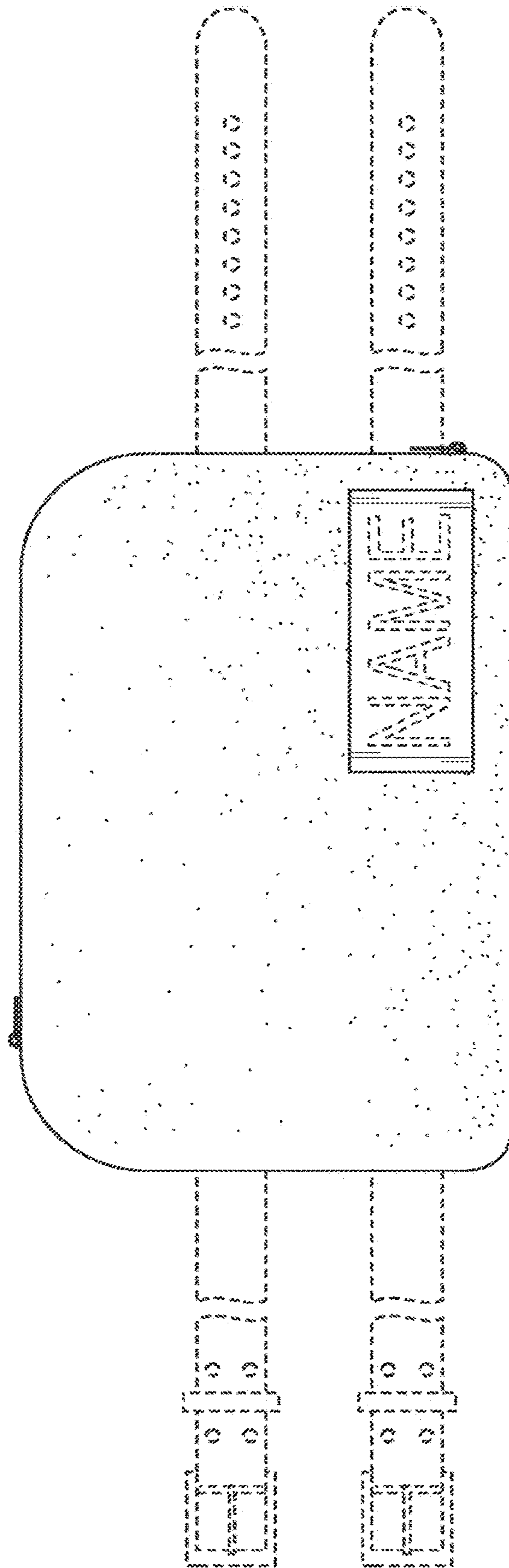

FIG. 9

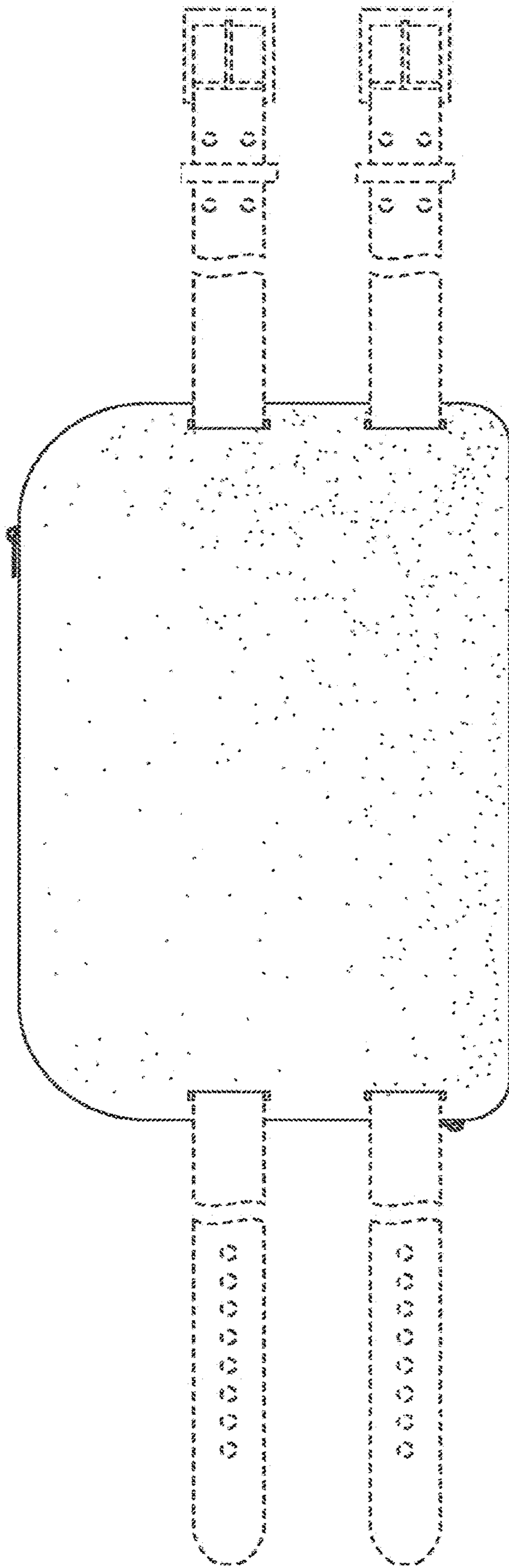

FIG. 10

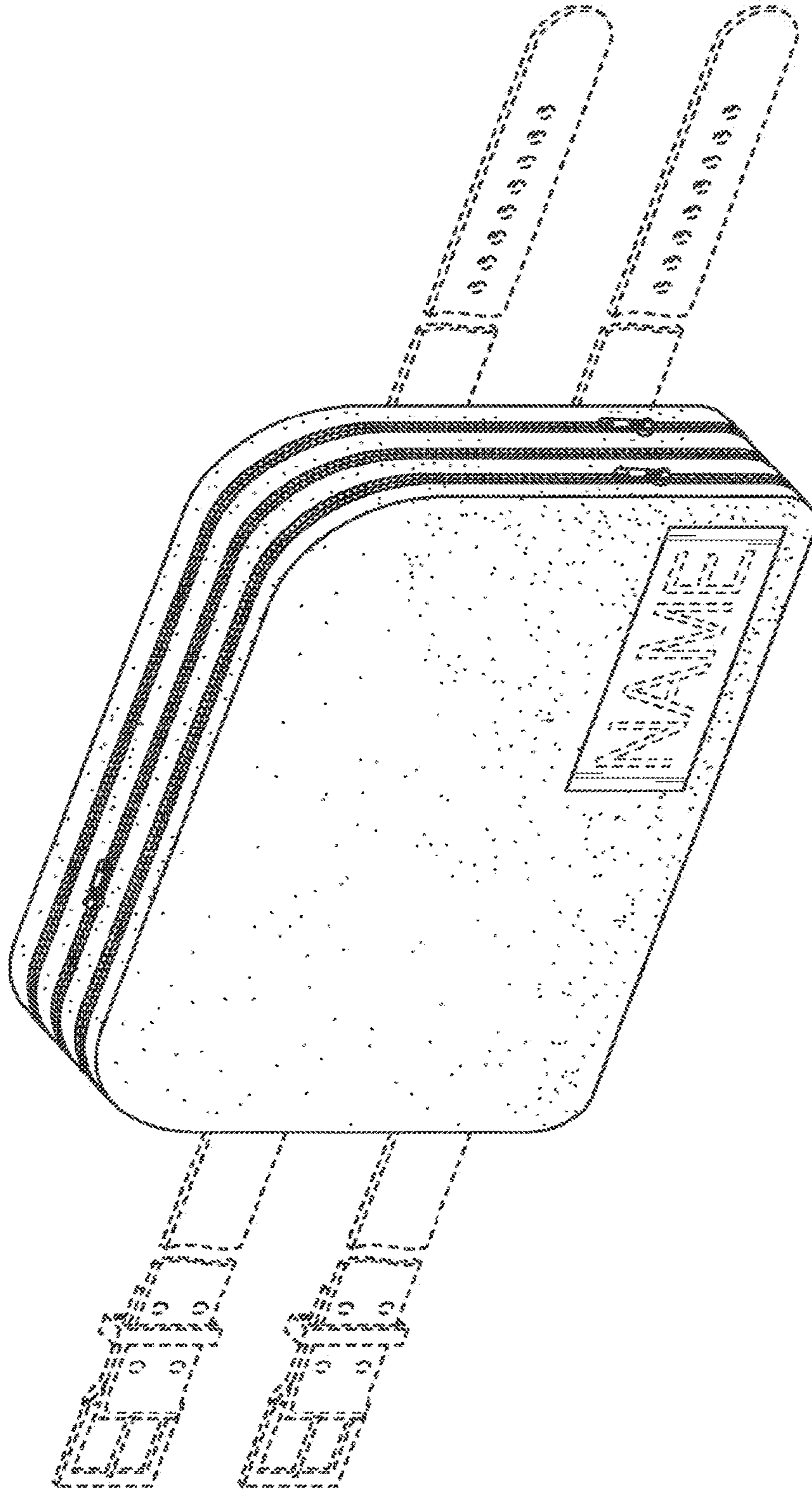

FIG. 11

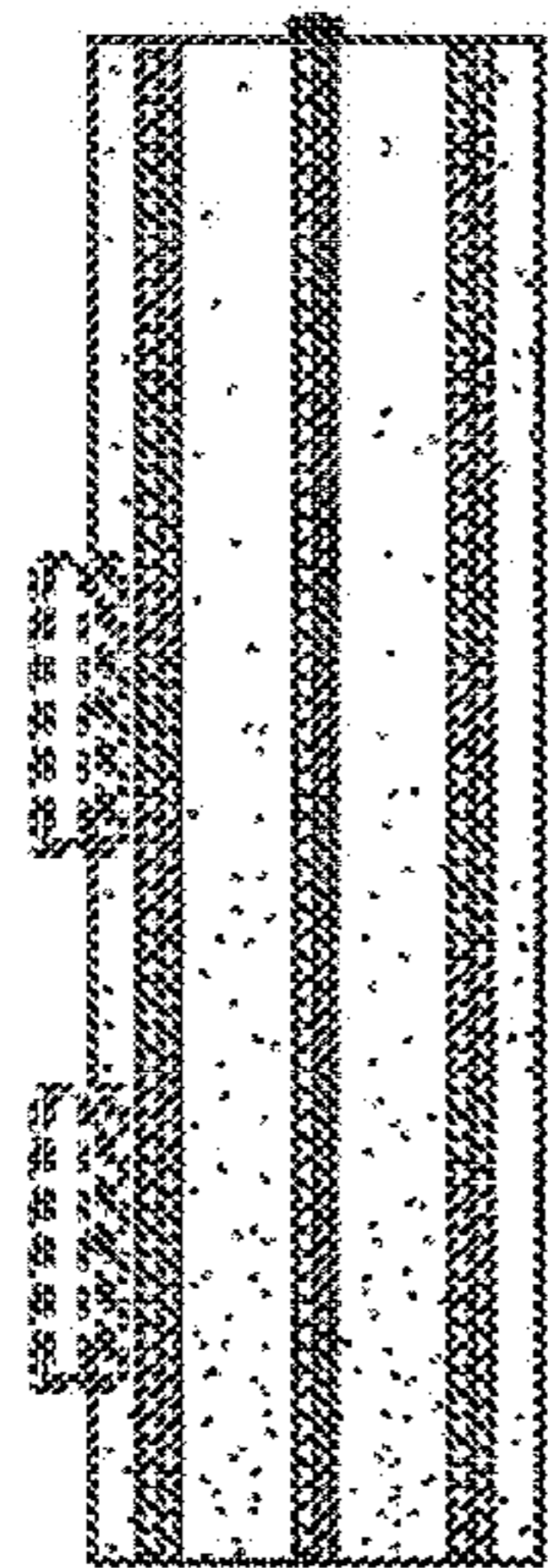

FIG. 12

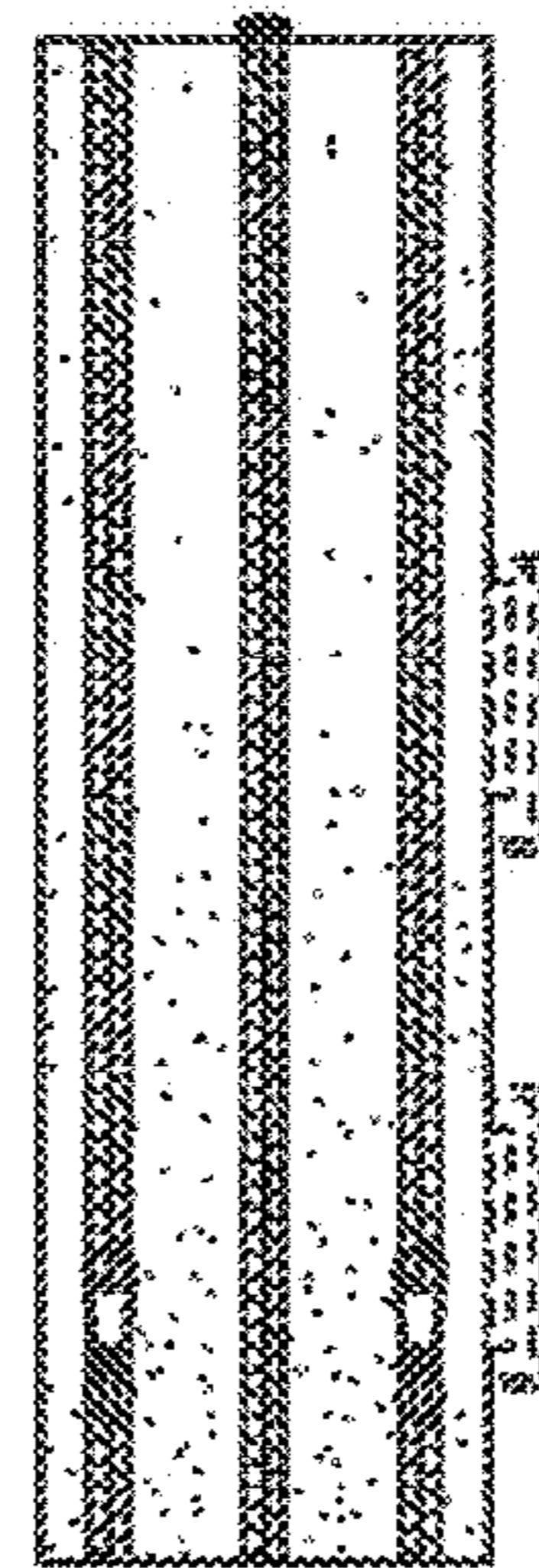

FIG. 13

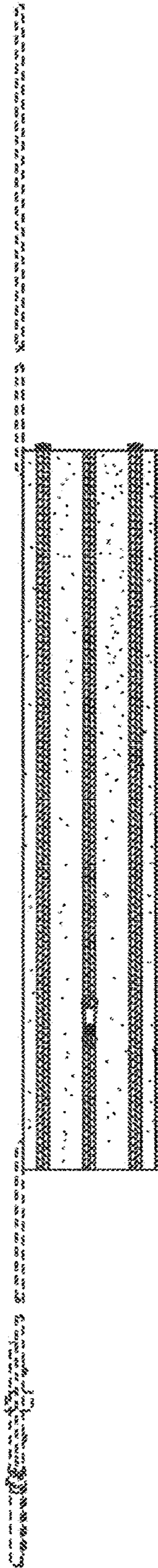

FIG. 14

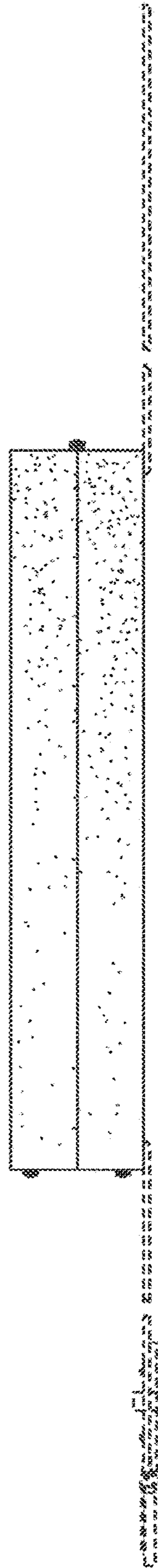

FIG. 15