

US00D893832S

(12) **United States Design Patent** (10) **Patent No.:** **US D893,832 S**  
**Teah, Sr.** (45) **Date of Patent:** **\*\* Aug. 25, 2020**

(54) **SHIRT COLLAR**  
(71) Applicant: **Melvin J. Teah, Sr.**, Baltimore, MD (US)  
(72) Inventor: **Melvin J. Teah, Sr.**, Baltimore, MD (US)  
(\*\*) Term: **15 Years**  
(21) Appl. No.: **29/657,157**  
(22) Filed: **Jul. 19, 2018**  
(51) **LOC (12) Cl.** ..... **02-02**  
(52) **U.S. Cl.**  
USPC ..... **D2/853**  
(58) **Field of Classification Search**  
USPC ..... D2/853, 840, 849, 717, 834, 602; 2/129  
CPC .... A41B 1/00; A41B 1/12; A41B 1/16; A41B 3/00; A41D 27/18  
See application file for complete search history.

D648,508 S \* 11/2011 Caselli ..... D2/840  
D657,938 S \* 4/2012 Atamian .....  
D665,152 S \* 8/2012 Morales ..... D2/840  
D709,268 S \* 7/2014 Kidman .....  
D732,278 S \* 6/2015 Dwamena ..... D2/853  
D754,420 S \* 4/2016 Greenblat .....  
D755,480 S \* 5/2016 Hernandez .....  
D756,596 S \* 5/2016 Santana .....  
D756,597 S \* 5/2016 Peerman ..... D2/739  
D765,354 S \* 9/2016 Nelson ..... D2/853  
D770,141 S \* 11/2016 Woosey .....  
D778,543 S \* 2/2017 Addesi ..... D2/853  
D780,409 S \* 3/2017 Drew ..... D2/840  
D798,030 S \* 9/2017 Ketcham .....  
D811,052 S \* 2/2018 Harris ..... D2/840  
D812,342 S \* 3/2018 Avalos ..... D2/602  
D812,343 S \* 3/2018 Avalos ..... D2/602  
D812,351 S \* 3/2018 Avalos ..... D2/840  
D812,859 S \* 3/2018 Avalos ..... D2/840  
D827,251 S \* 9/2018 Mong ..... D2/731  
D830,038 S \* 10/2018 Sabga ..... D2/717  
D841,292 S \* 2/2019 Vance ..... D2/840  
2004/0010837 A1 1/2004 Graves .....  
(Continued)

Primary Examiner — Barbara Fox  
Assistant Examiner — J. Thorn, Sr.

(56) **References Cited**

U.S. PATENT DOCUMENTS

1,488,539 A \* 4/1924 Harsh ..... A41D 1/04  
2/122  
D128,404 S \* 7/1941 Salsky ..... D2/840  
D185,093 S \* 5/1959 Moss ..... D2/840  
D302,347 S \* 7/1989 Rodriguez, Jr. et al. ....  
D336,360 S \* 6/1993 Perryman ..... D2/602  
D350,012 S \* 8/1994 Christy et al. ....  
D373,893 S \* 9/1996 Patel et al. ....  
D405,235 S \* 2/1999 Dickie ..... D2/602  
D421,328 S \* 3/2000 Glennie ..... D2/602  
D499,230 S \* 12/2004 Young ..... D2/602  
D560,879 S \* 2/2008 Hines ..... D2/840  
D571,079 S \* 6/2008 Gay ..... D2/717  
D584,483 S \* 1/2009 Glynn .....  
D622,037 S \* 8/2010 Hall et al. ....  
D635,334 S \* 4/2011 Eckman et al. ....  
D640,858 S \* 7/2011 Hall et al. ....

(57) **CLAIM**

The ornamental design for a shirt collar, as shown and described.

**DESCRIPTION**

FIG. 1 is a front right perspective view of a shirt collar;  
FIG. 2 is a front left perspective view thereof;  
FIG. 3 is a front elevation view thereof;  
FIG. 4 is a right elevation view thereof;  
FIG. 5 is a back elevation view thereof; and,  
FIG. 6 is a top plan view thereof.  
The broken lines shown in the drawings depict portions of a shirt that form no part of the claimed invention.

**1 Claim, 4 Drawing Sheets**

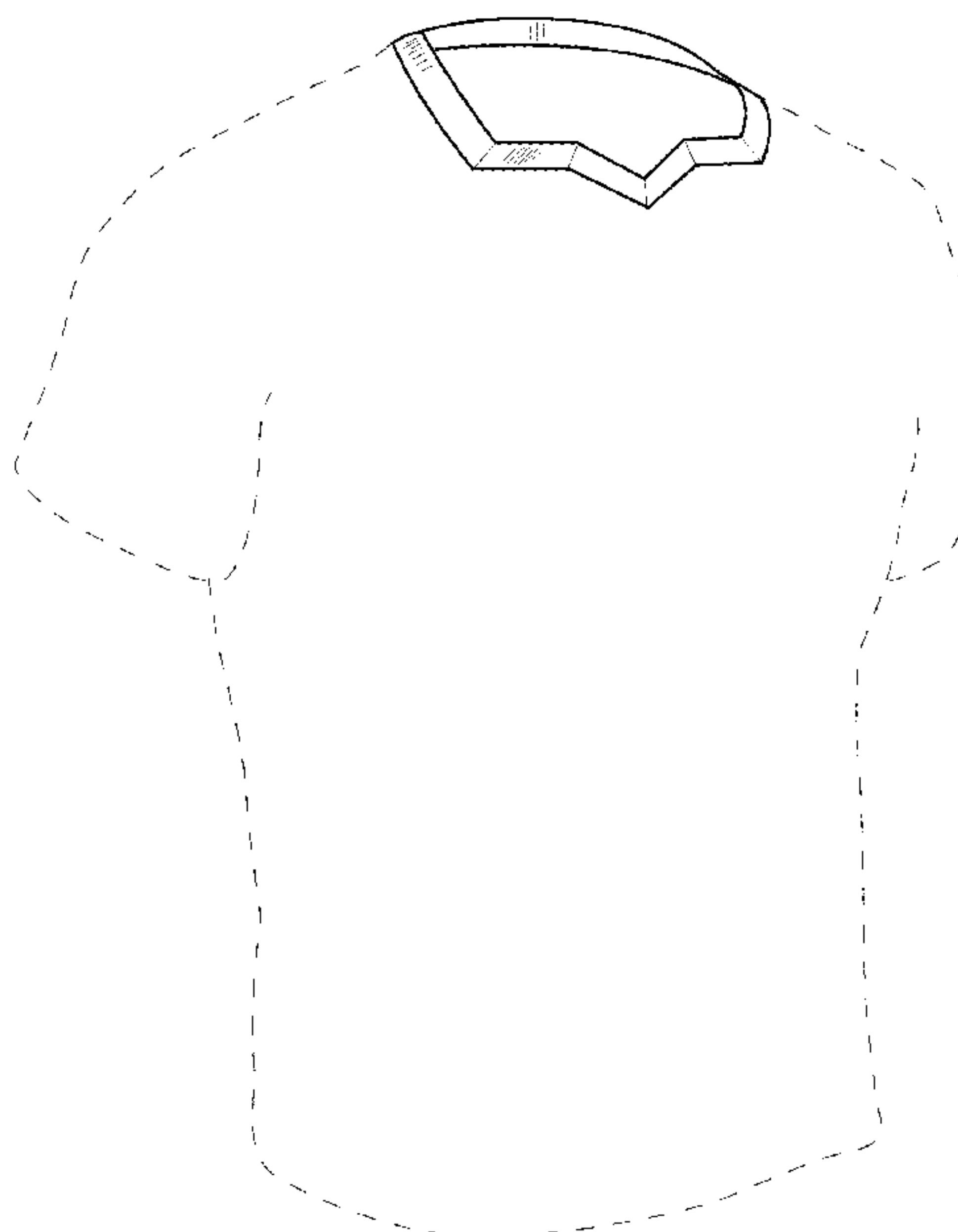

(56)

**References Cited**

U.S. PATENT DOCUMENTS

2014/0000004 A1\* 1/2014 Baron ..... A41B 1/00  
2/69  
2018/0184723 A1\* 7/2018 Ricks ..... A41D 27/04

\* cited by examiner

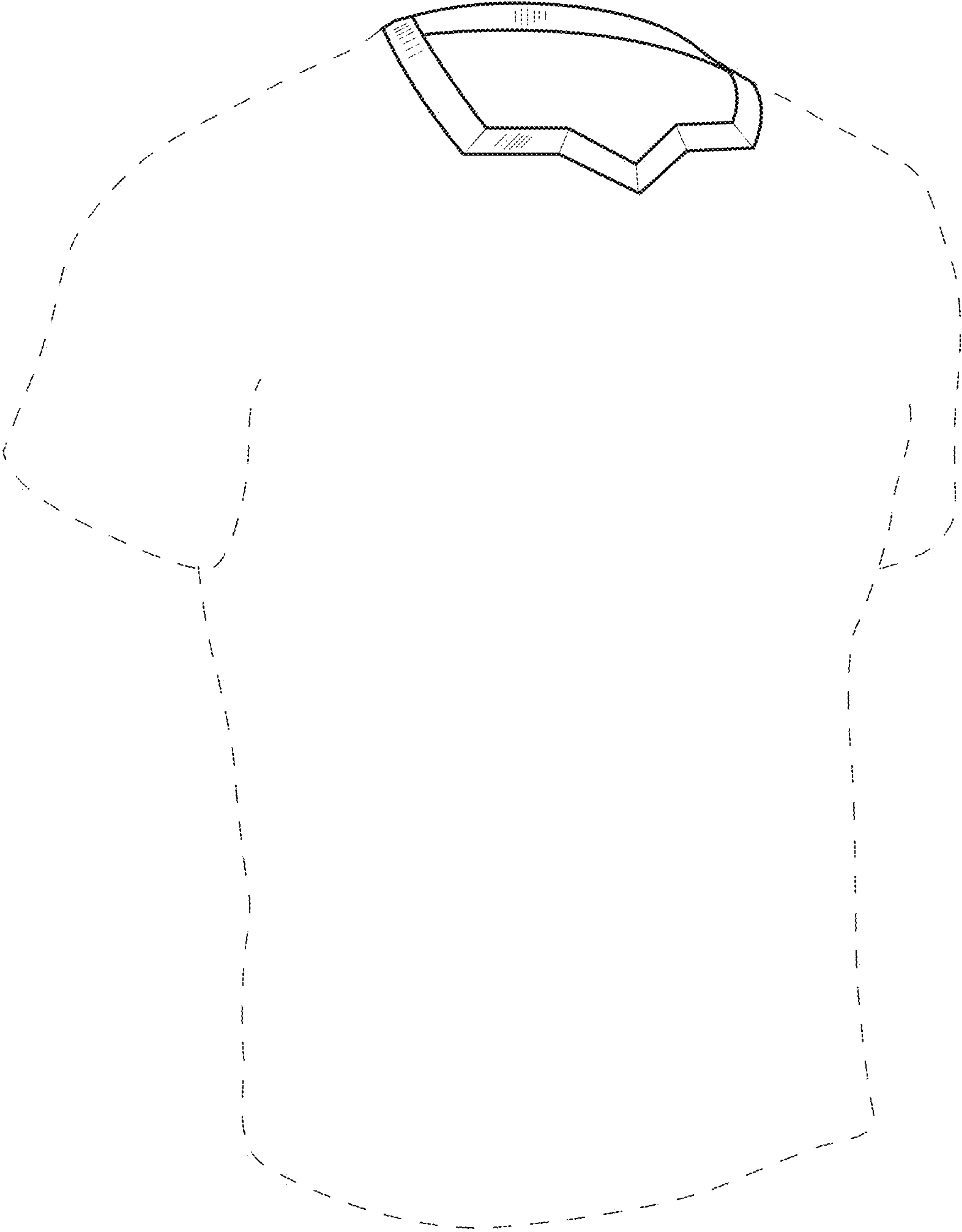

FIG. 1

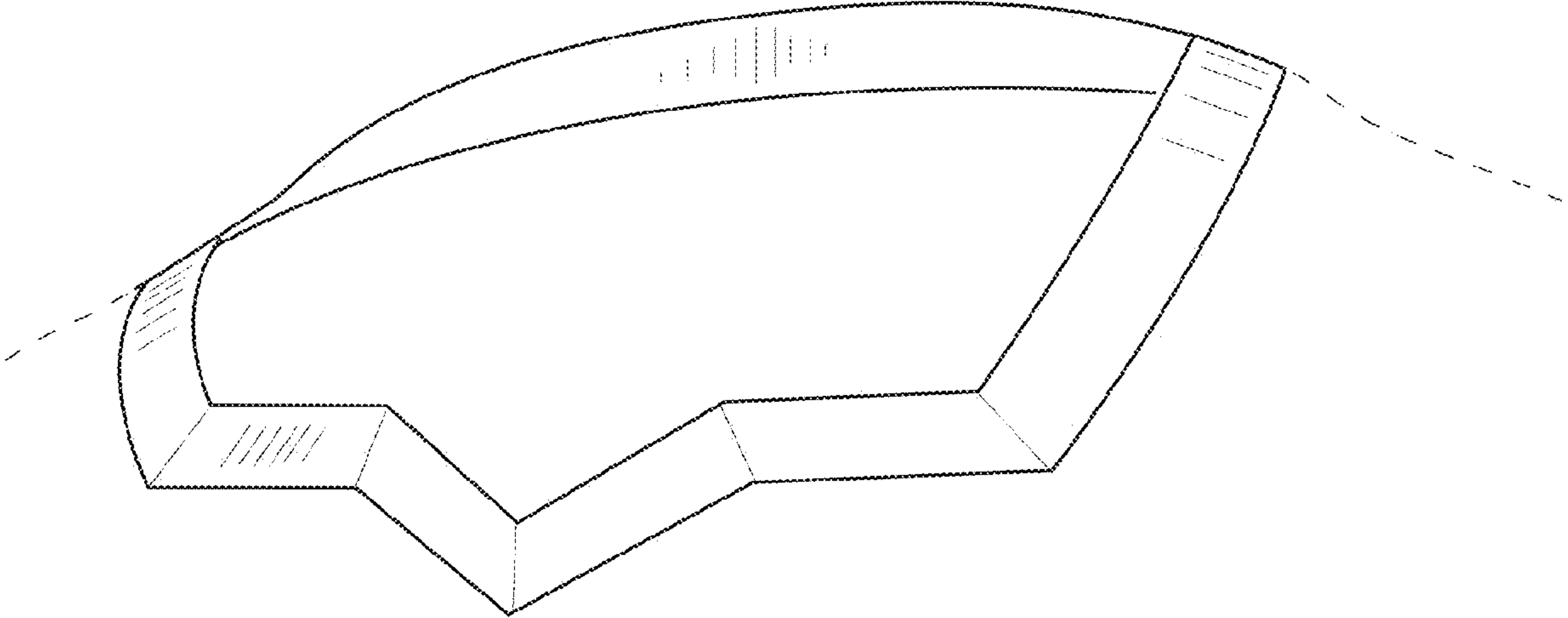

FIG. 2

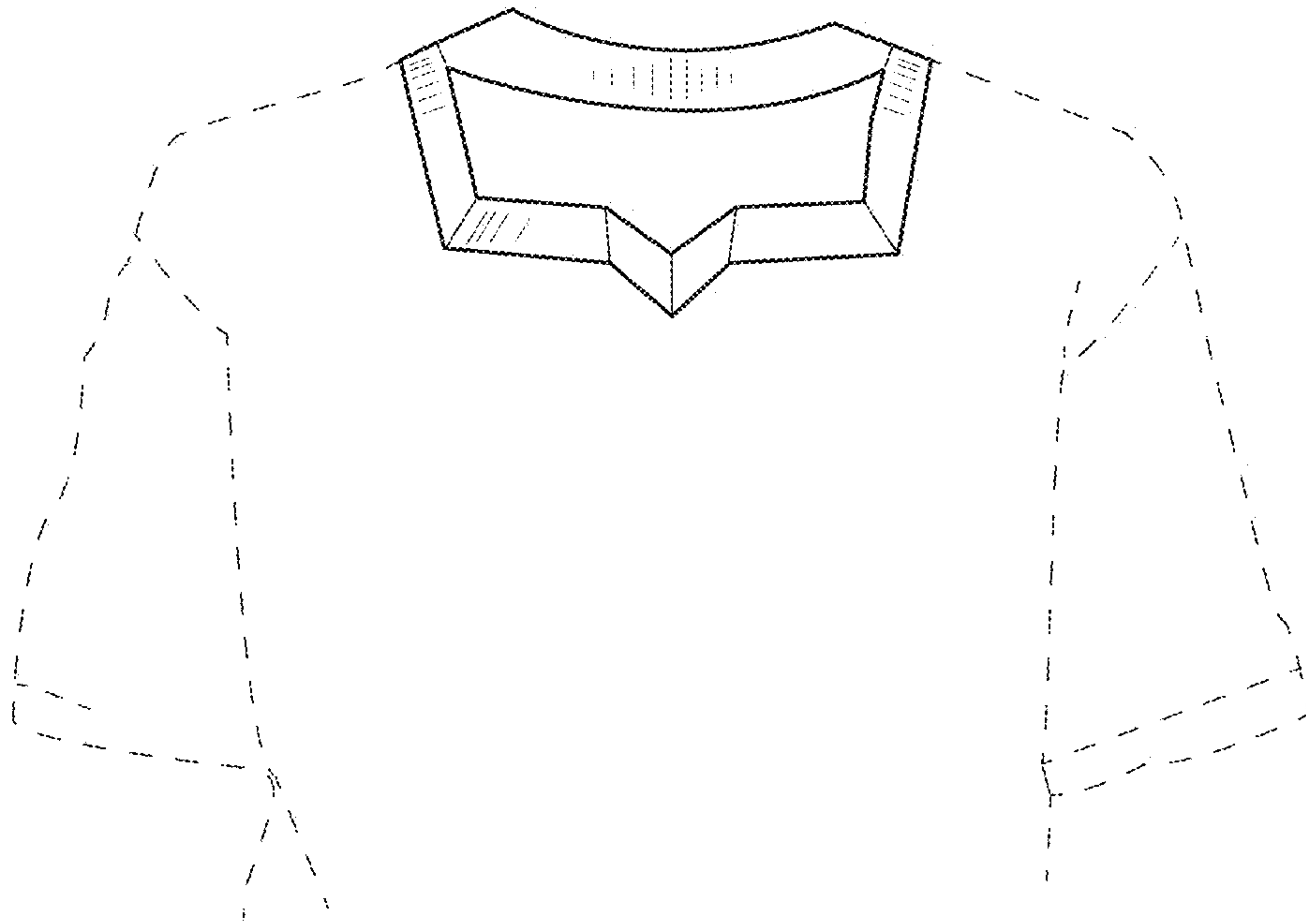

FIG. 3

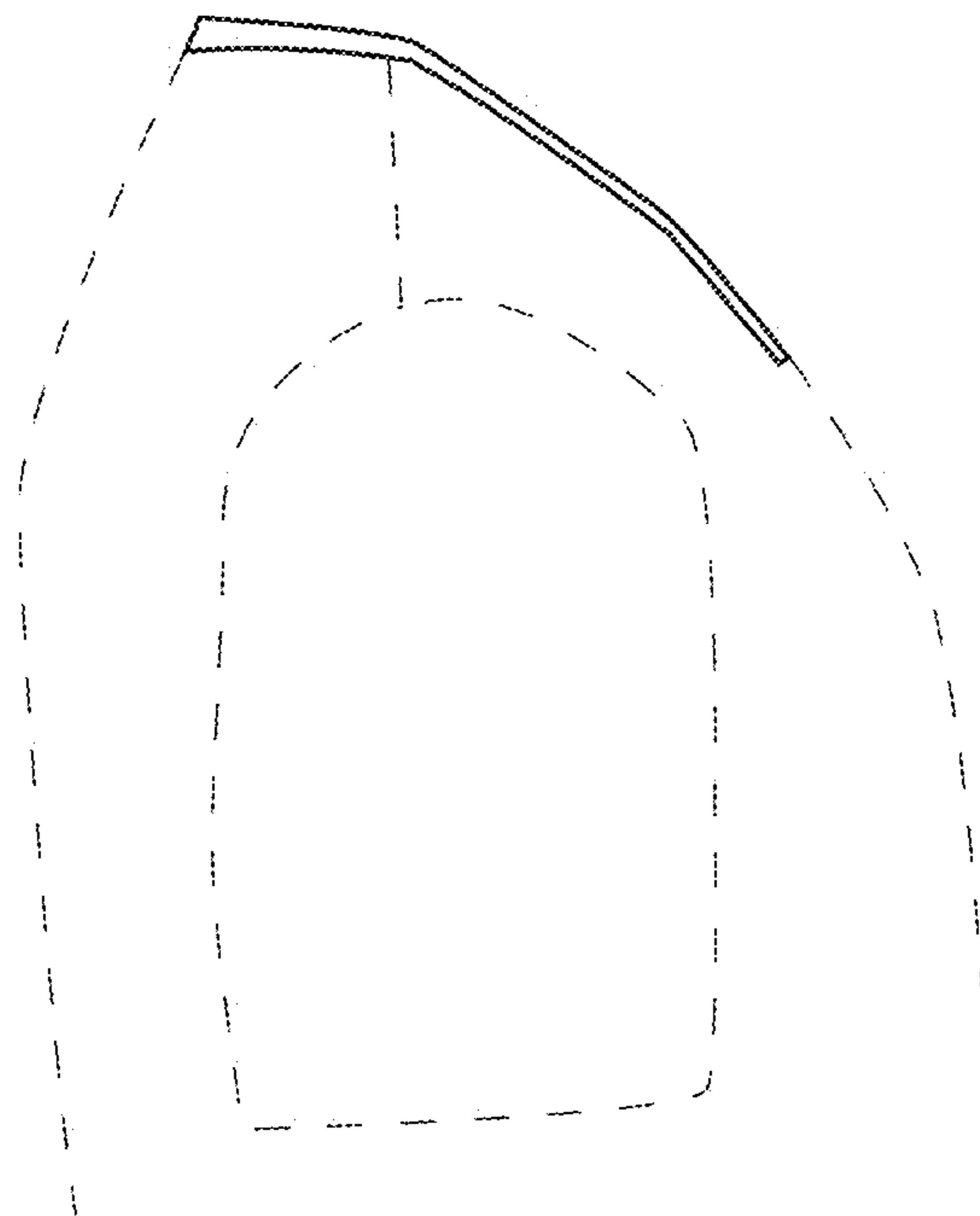

FIG. 4

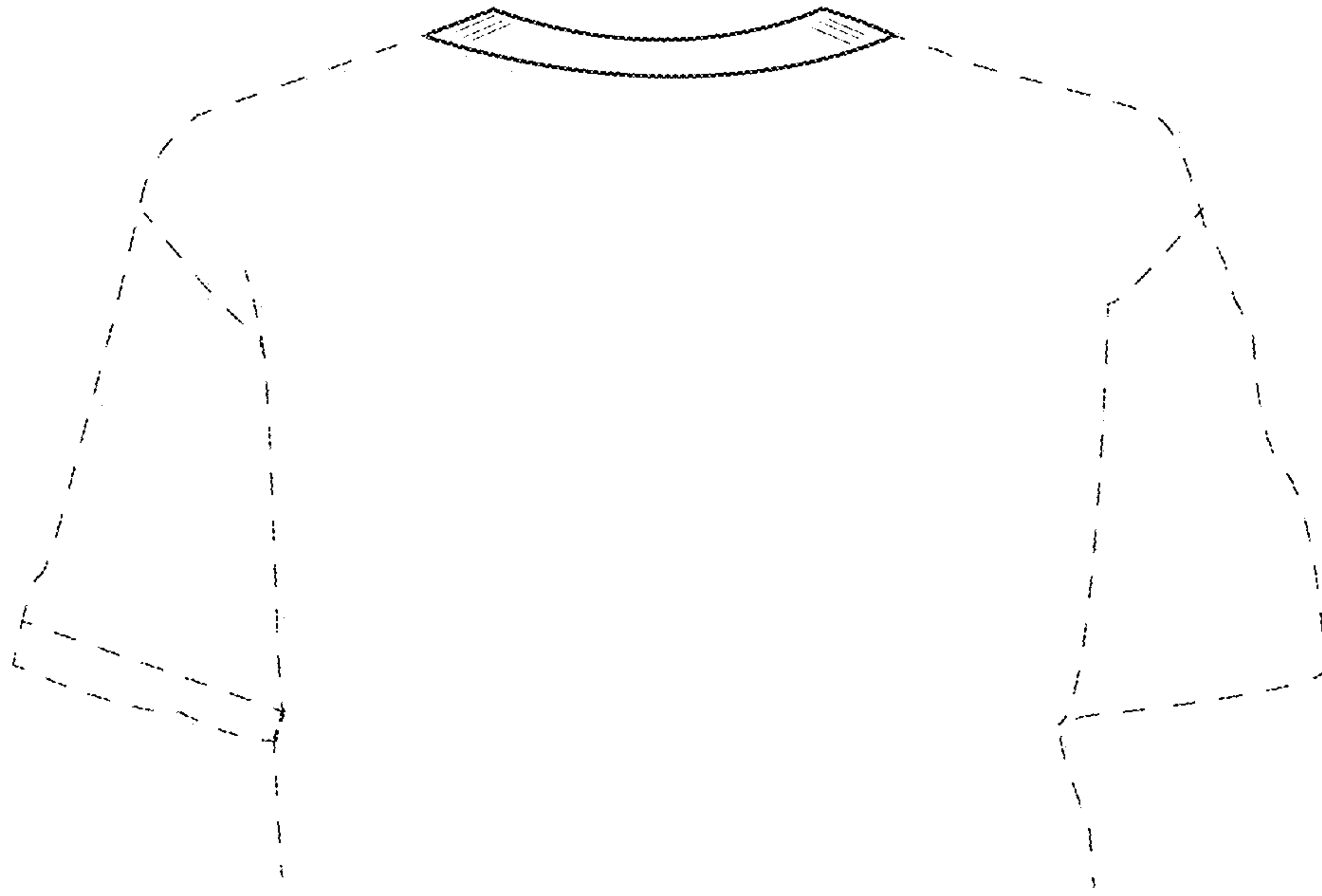

FIG. 5

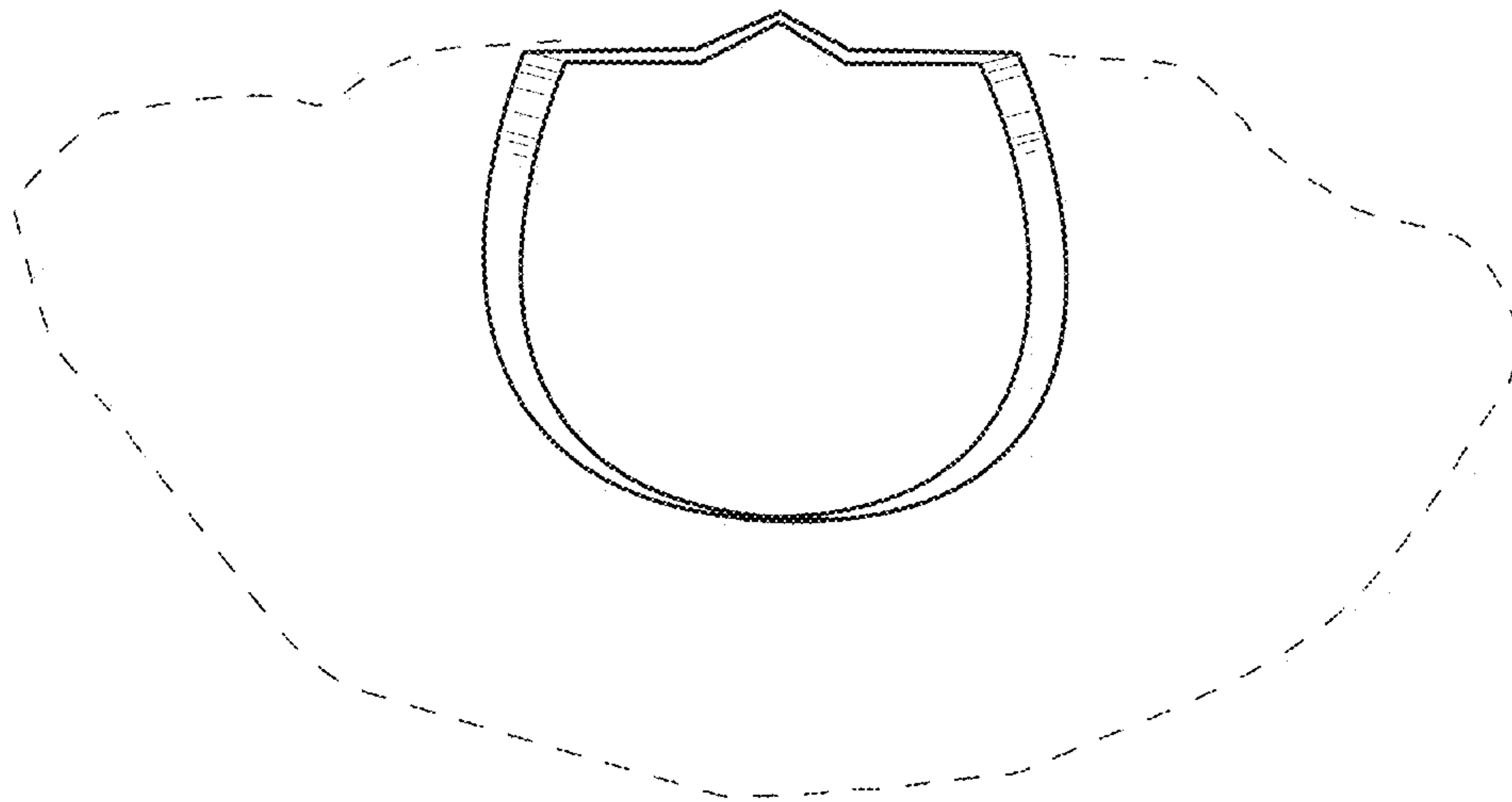

FIG. 6