



US00D893818S

(12) **United States Design Patent** (10) **Patent No.:** **US D893,818 S**
No et al. (45) **Date of Patent:** **** Aug. 18, 2020**

(54) **WASHING MACHINE**

37/225; D06F 37/24; D06F 37/267; D06F 37/28; D06F 37/36; D06F 37/40; D06F 39/005; D06F 39/006; D06F 39/007; D06F 39/024; D06F 39/12; D06F 39/14; D06F 58/20

(71) Applicant: **LG ELECTRONICS INC.**, Seoul (KR)

See application file for complete search history.

(72) Inventors: **Yanghwan No**, Seoul (KR); **Minkyu Oh**, Seoul (KR); **Seongwoo An**, Seoul (KR); **Yongnam Kim**, Seoul (KR)

(56) **References Cited**

(73) Assignee: **LG ELECTRONICS INC.**, Seoul (KR)

U.S. PATENT DOCUMENTS

(**) Term: **15 Years**

D139,126	S	*	10/1944	Gerhardt	D32/6
D153,921	S	*	5/1949	Boldt	D32/6
D178,004	S	*	6/1956	Nadherny	D32/6
D476,782	S	*	7/2003	Huddleston	D32/6
D688,013	S	*	8/2013	Kim	D32/6
D764,723	S	*	8/2016	Jo	D32/6
D781,510	S	*	3/2017	Glassman	D32/6
D825,868	S	*	8/2018	Chung	D32/6
D838,063	S	*	1/2019	Ha	D32/6
D838,419	S	*	1/2019	Ha	D32/6
D839,504	S	*	1/2019	Ha	D32/6
D867,693	S	*	11/2019	Wang	D32/6

(21) Appl. No.: **35/507,323**

(22) Filed: **Nov. 22, 2018**

(80) **Hague Agreement Data**

Int. Filing Date: **Nov. 22, 2018**
Int. Reg. No.: **DM/202422**
Int. Reg. Date: **Nov. 22, 2018**
Int. Reg. Pub. Date: **Aug. 30, 2019**

* cited by examiner

Primary Examiner — Khawaja Anwar

(30) **Foreign Application Priority Data**

May 28, 2018 (KR) 30-2018-0024701

(74) *Attorney, Agent, or Firm* — Birch, Stewart, Kolasch & Birch, LLP

(51) **LOC (12) Cl.** **15-05**

(57) **CLAIM**

(52) **U.S. Cl.**
USPC **D32/6**

The ornamental design for a washing machine, as shown and described.

(58) **Field of Classification Search**

USPC D32/1, 5, 6, 8, 10, 25, 28, 29, 29.1
CPC D06F 33/02; D06F 37/22; D06F 39/02; D06F 2058/2864; D06F 2058/287; D06F 2204/086; D06F 35/006; D06F 37/265; D06F 37/268; D06F 58/206; D06F 58/28; D06F 13/00; D06F 13/02; D06F 17/06; D06F 17/10; D06F 2202/085; D06F 2202/10; D06F 2202/12; D06F 2204/04; D06F 2204/065; D06F 2204/082; D06F 2222/00; D06F 23/04; D06F 25/00; D06F 29/005; D06F 37/02; D06F 37/04; D06F 37/14; D06F 37/203; D06F 37/206; D06F

DESCRIPTION

- 1. Washing machine
- 1.1 : Perspective
- 1.2 : Front
- 1.3 : Back
- 1.4 : Left
- 1.5 : Right
- 1.6 : Top
- 1.7 : Bottom

1 Claim, 7 Drawing Sheets

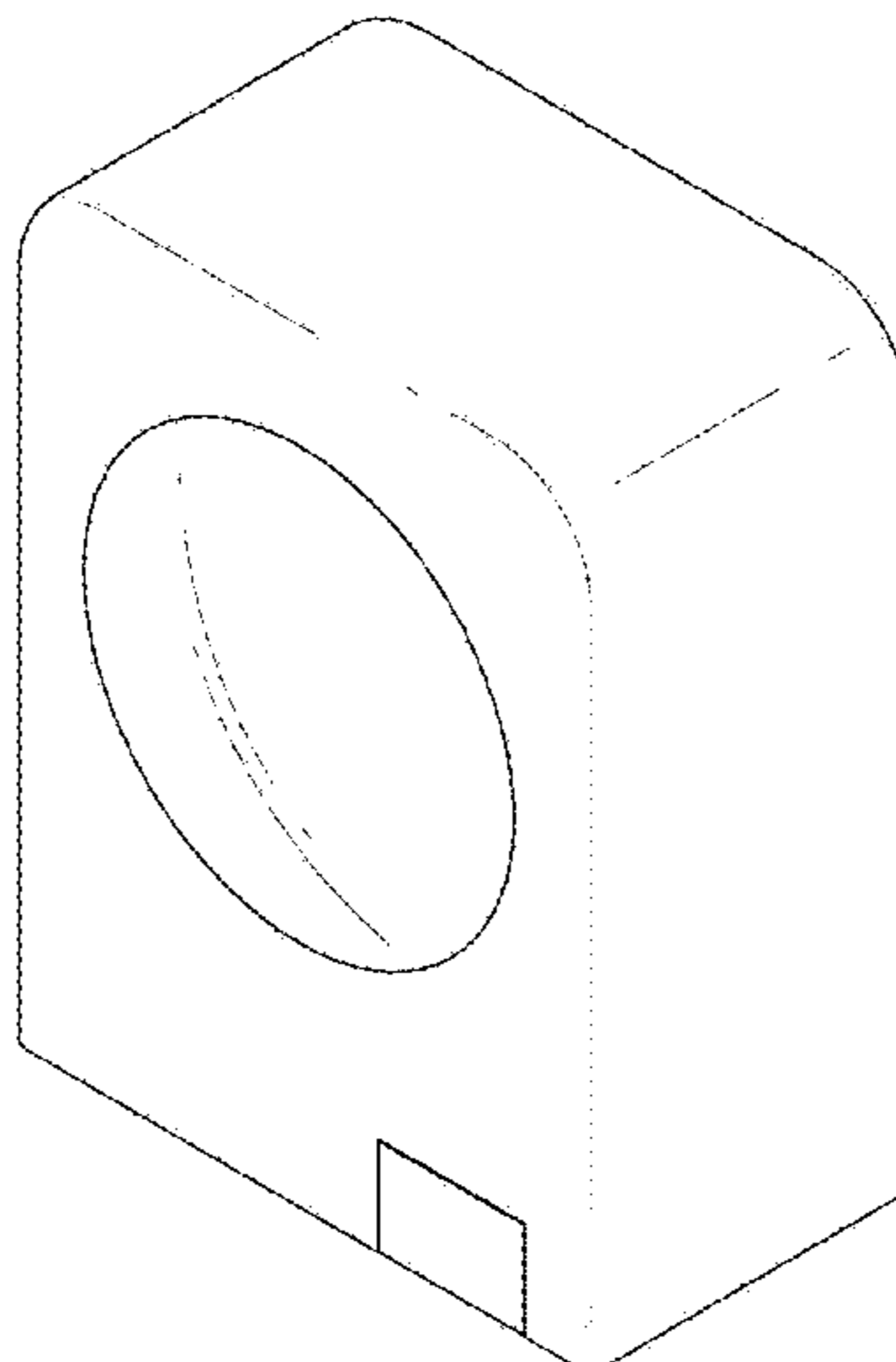

1.1

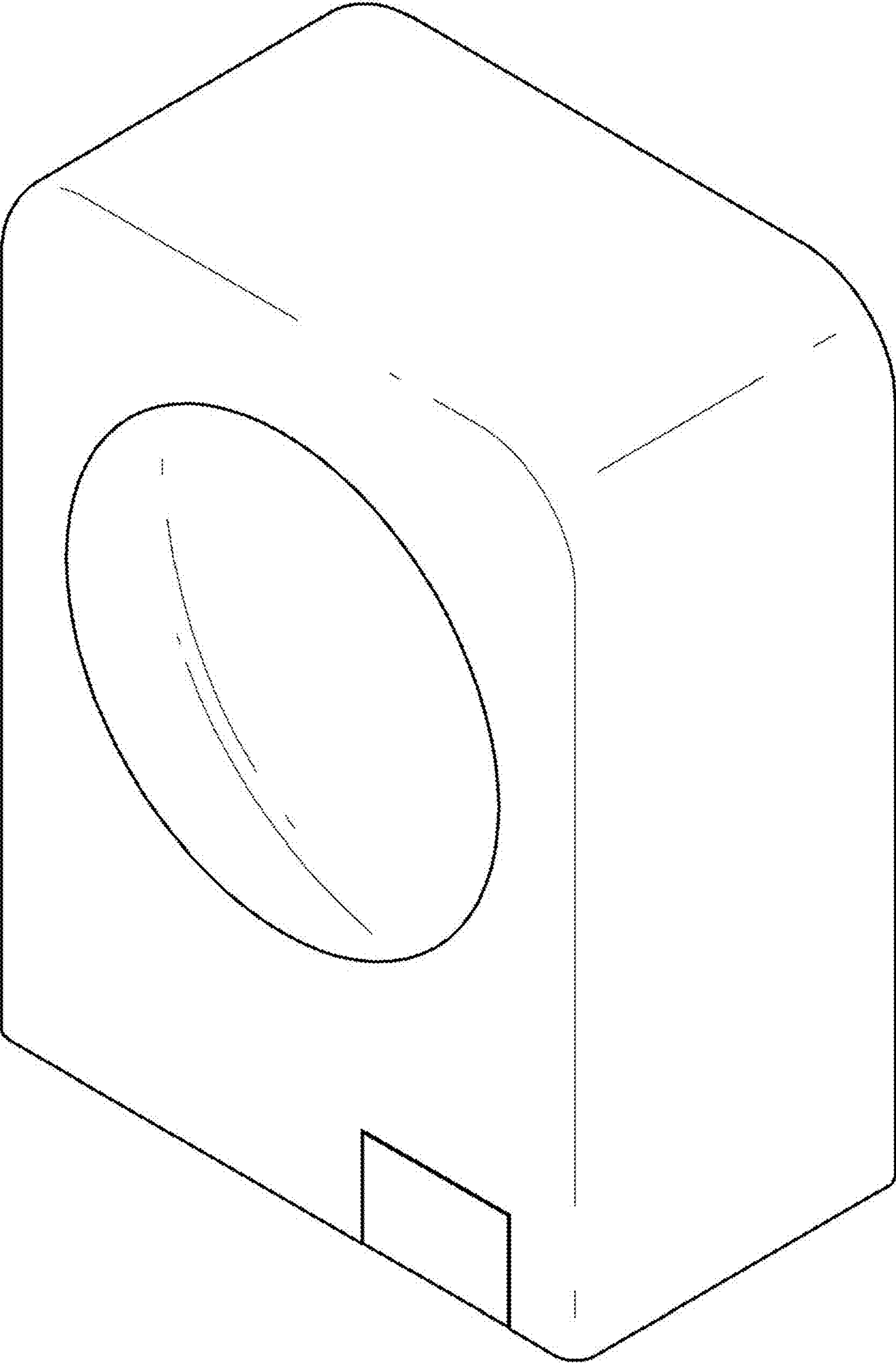

1.2

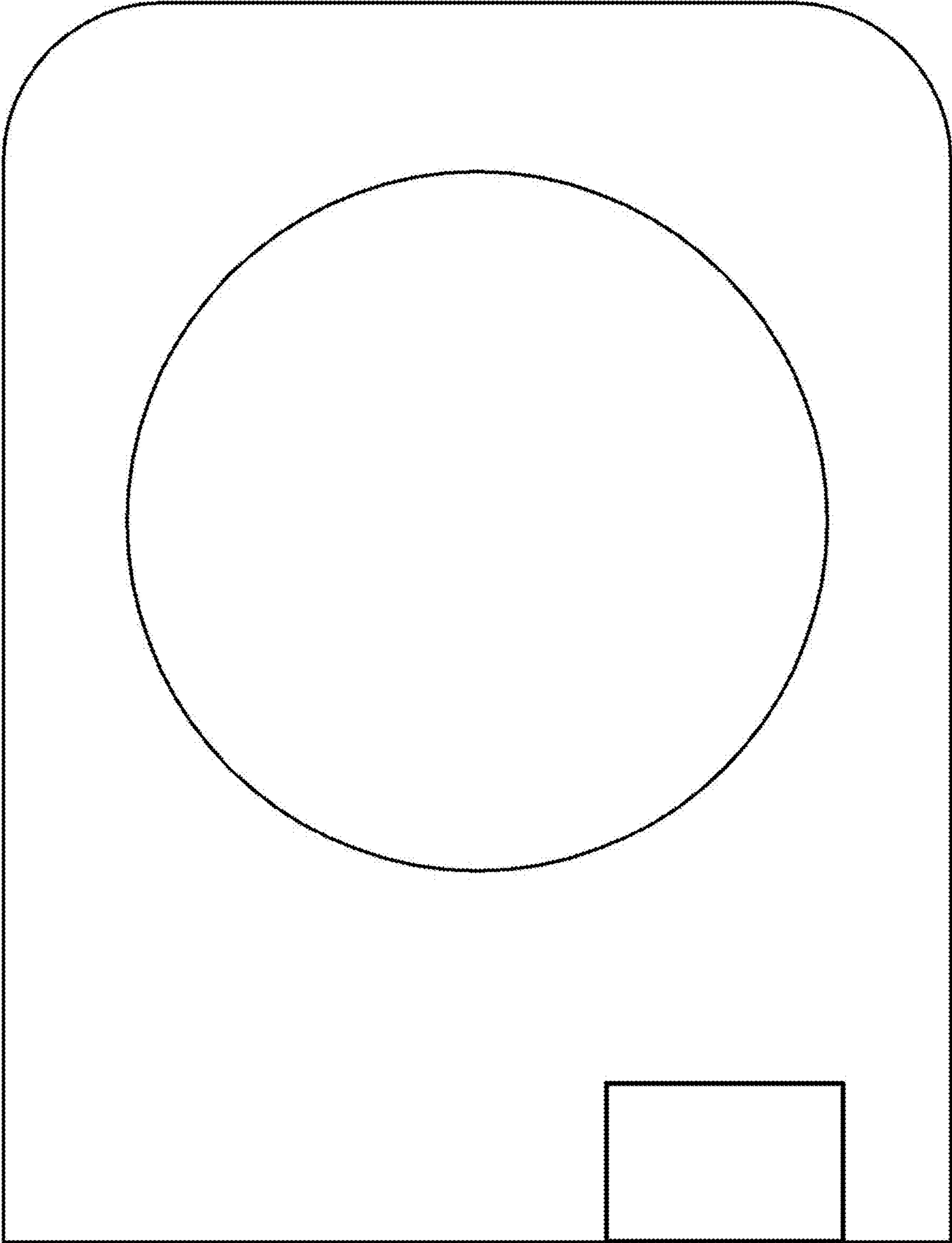

1.3

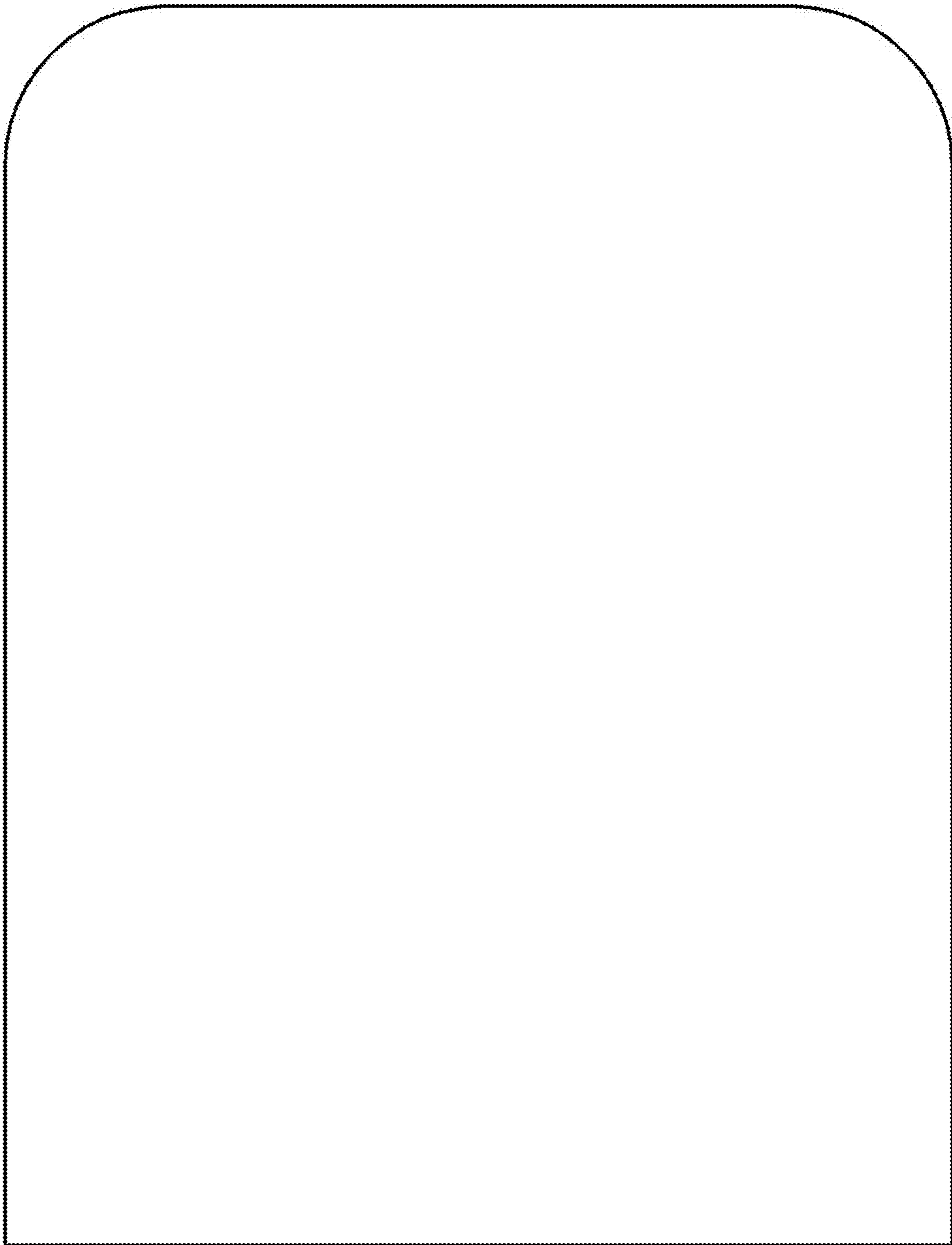

1.4

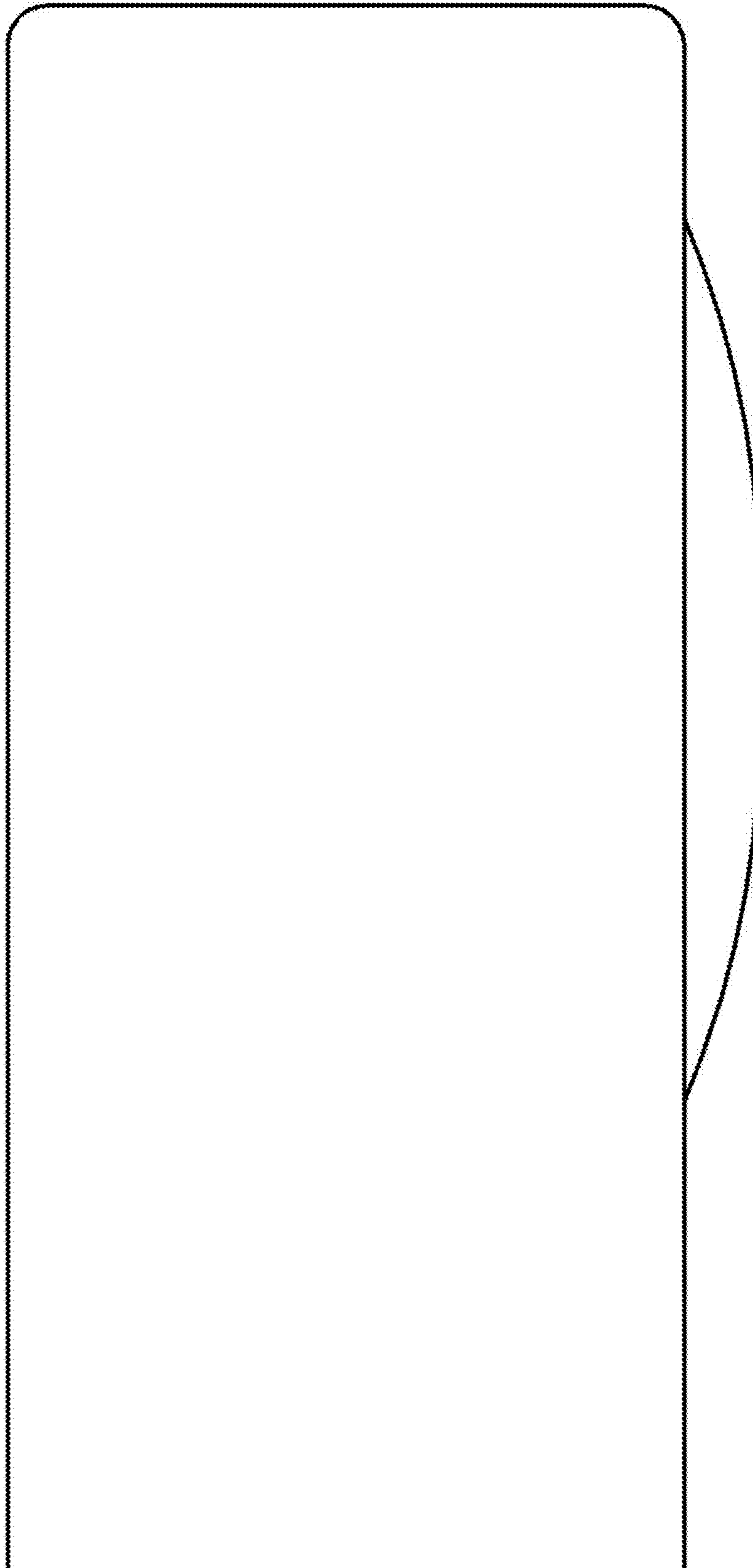

1.5

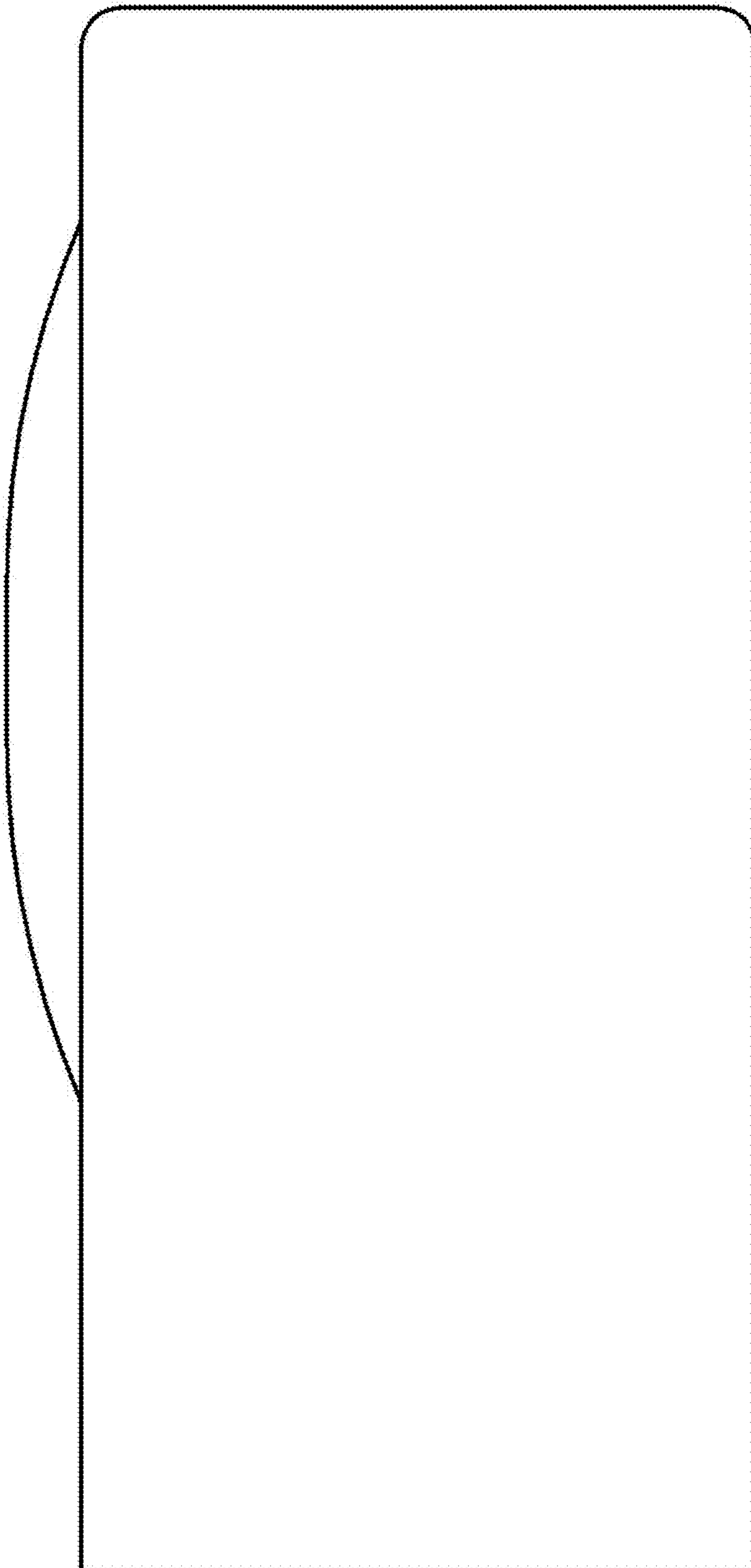

1.6

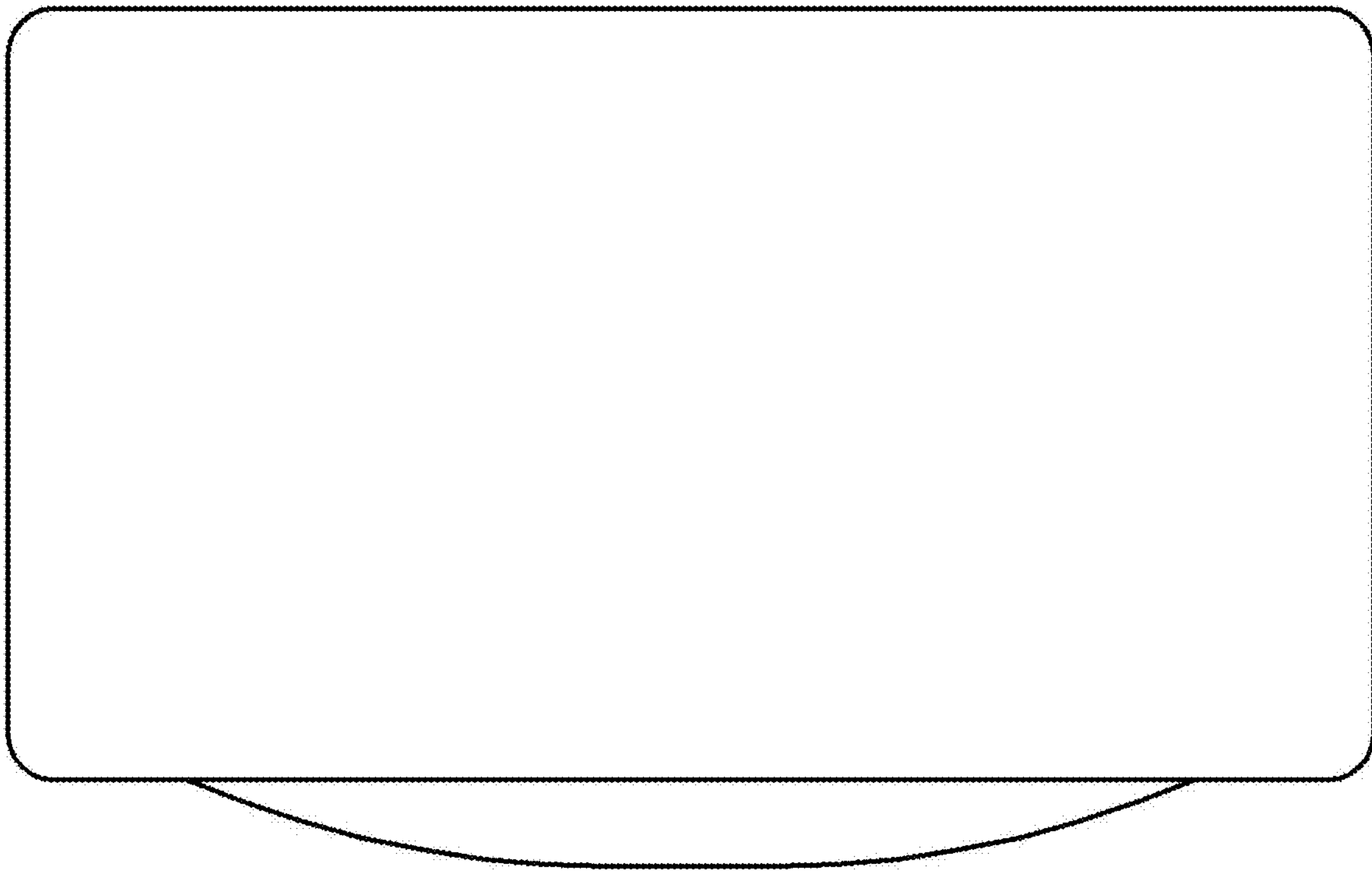

1.7

