



US00D893793S

(12) **United States Design Patent** (10) **Patent No.:** **US D893,793 S**
Velez (45) **Date of Patent:** **** Aug. 18, 2020**

(54) **LAMP**
(71) Applicant: **Holly Hunt Enterprises, Inc.**, Chicago, IL (US)
(72) Inventor: **Alberto Velez**, Chicago, IL (US)
(73) Assignee: **Holly Hunt Enterprises, Inc.**
(**) Term: **15 Years**

7,857,493 B2 * 12/2010 Engel F21S 6/005
362/153
D646,414 S * 10/2011 Wauters D26/63

* cited by examiner

Primary Examiner — Brian N. Vinson
(74) *Attorney, Agent, or Firm* — The Belles Group, P.C.

(21) Appl. No.: **29/650,722**
(22) Filed: **Jun. 8, 2018**
(51) **LOC (12) Cl.** **26-03**
(52) **U.S. Cl.**
USPC **D26/106**
(58) **Field of Classification Search**
USPC D26/24, 37, 51, 61, 63, 65, 72, 80, 118,
D26/93, 106, 110
CPC F21S 8/04; F21S 8/00; F21V 21/00; F21V
17/02; F21V 14/02; F21V 21/30; F21V
21/14; F21V 21/26; F21W 2131/10
See application file for complete search history.

(57) **CLAIM**

I claim the ornamental design for a lamp, as shown and described.

DESCRIPTION

FIG. 1 is a front perspective view of a lamp showing my new design.
FIG. 2 is a front elevation view thereof.
FIG. 3 is a rear elevation view thereof.
FIG. 4 is a left side view thereof.
FIG. 5 is a right side view thereof 1.
FIG. 6 is a top plan view thereof.
FIG. 7 is a bottom plan view thereof; and,
FIG. 8 is an exploded view thereof.

(56) **References Cited**
U.S. PATENT DOCUMENTS

D526,735 S * 8/2006 Targetti D26/63

1 Claim, 7 Drawing Sheets

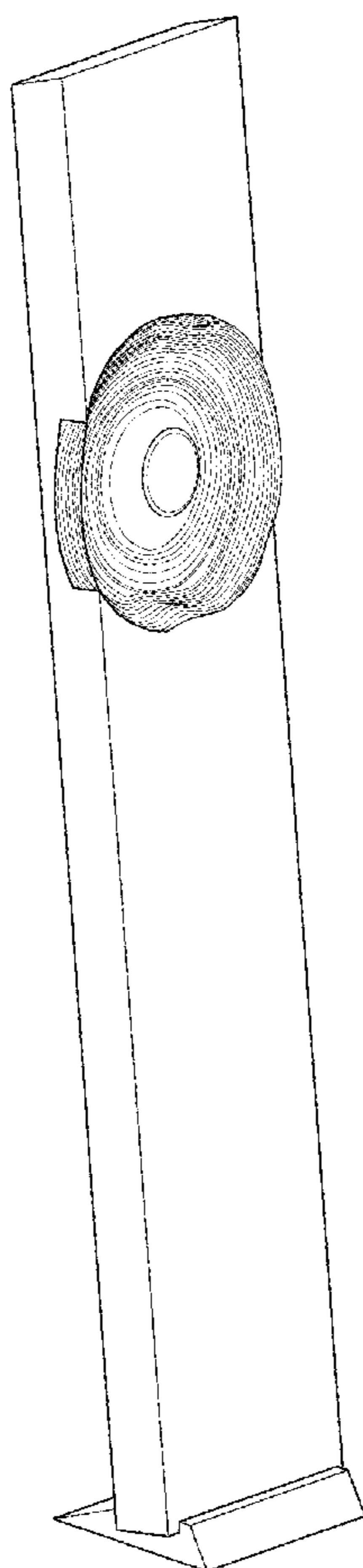

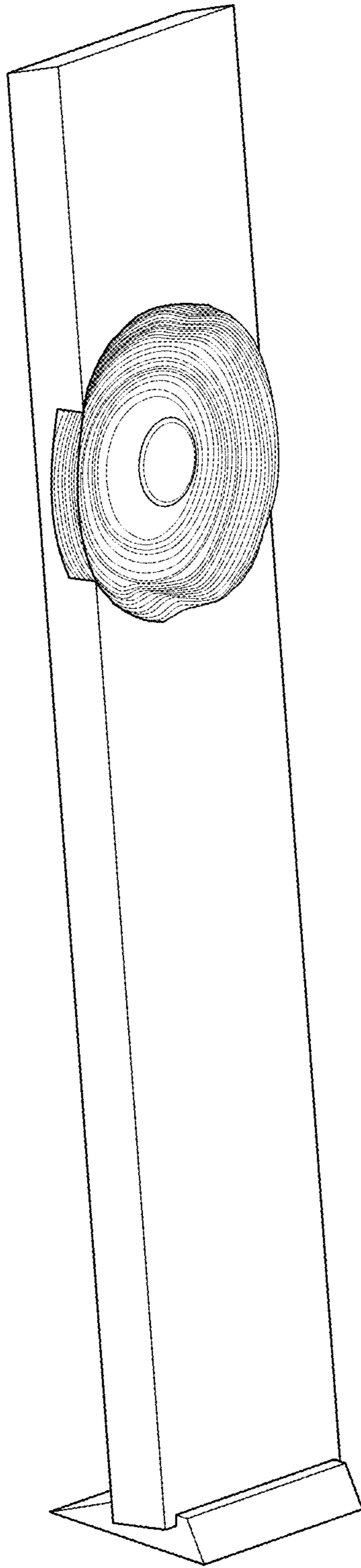

FIG. 1

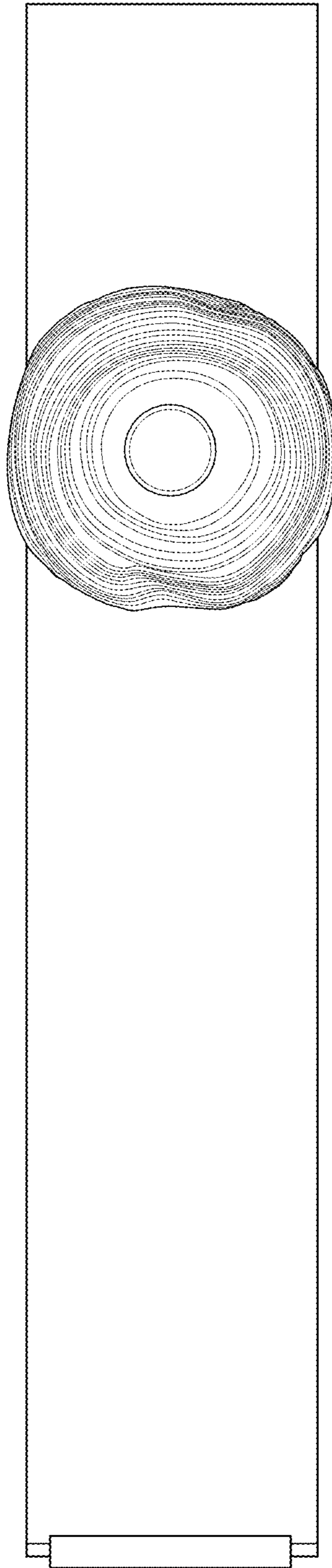

FIG. 2

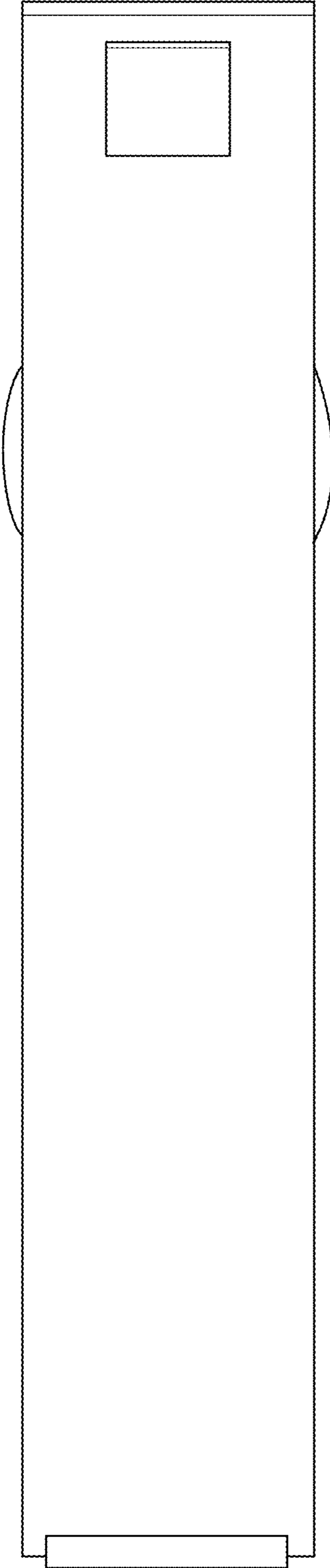

FIG. 3

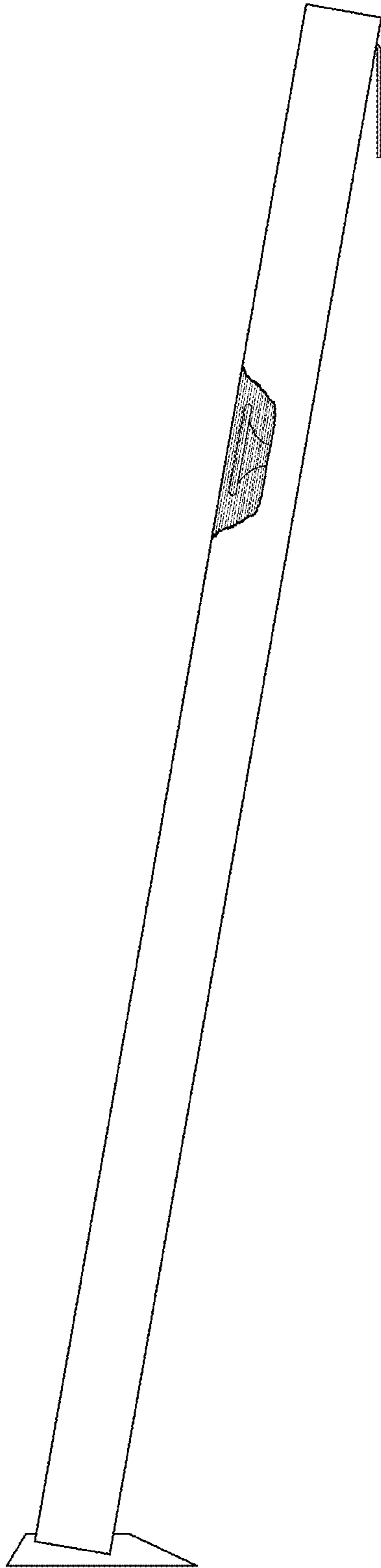

FIG. 4

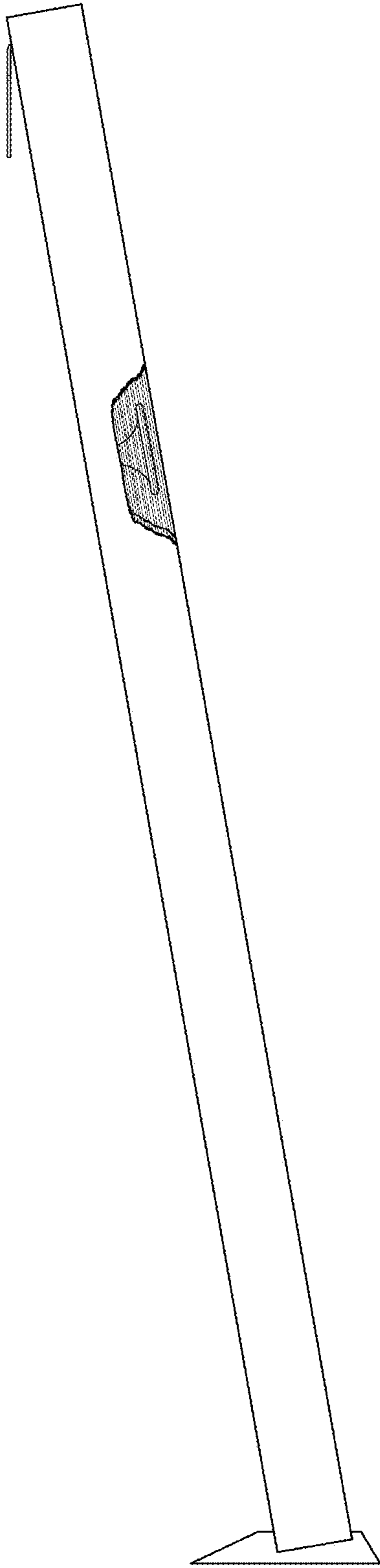

FIG. 5

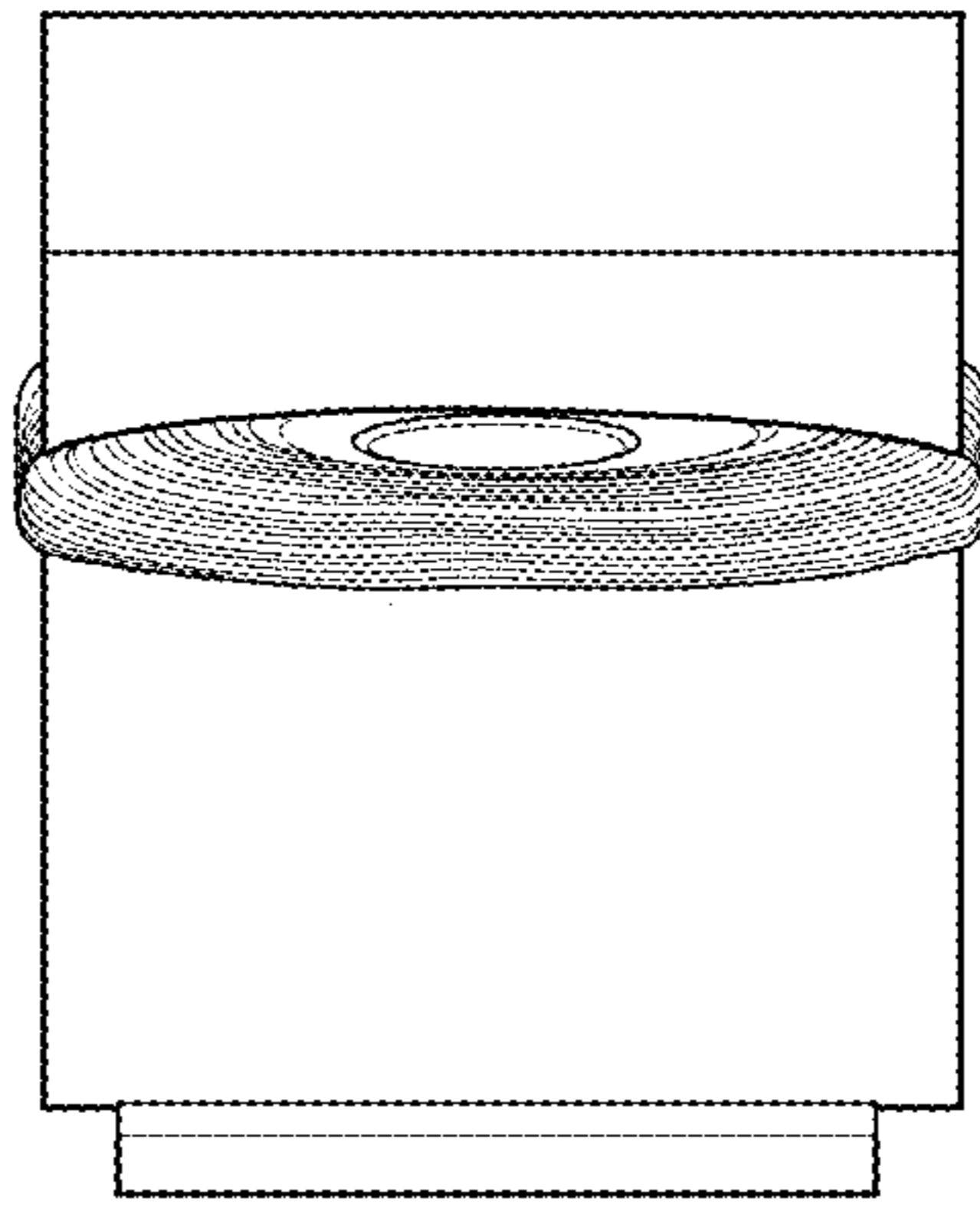

FIG. 6

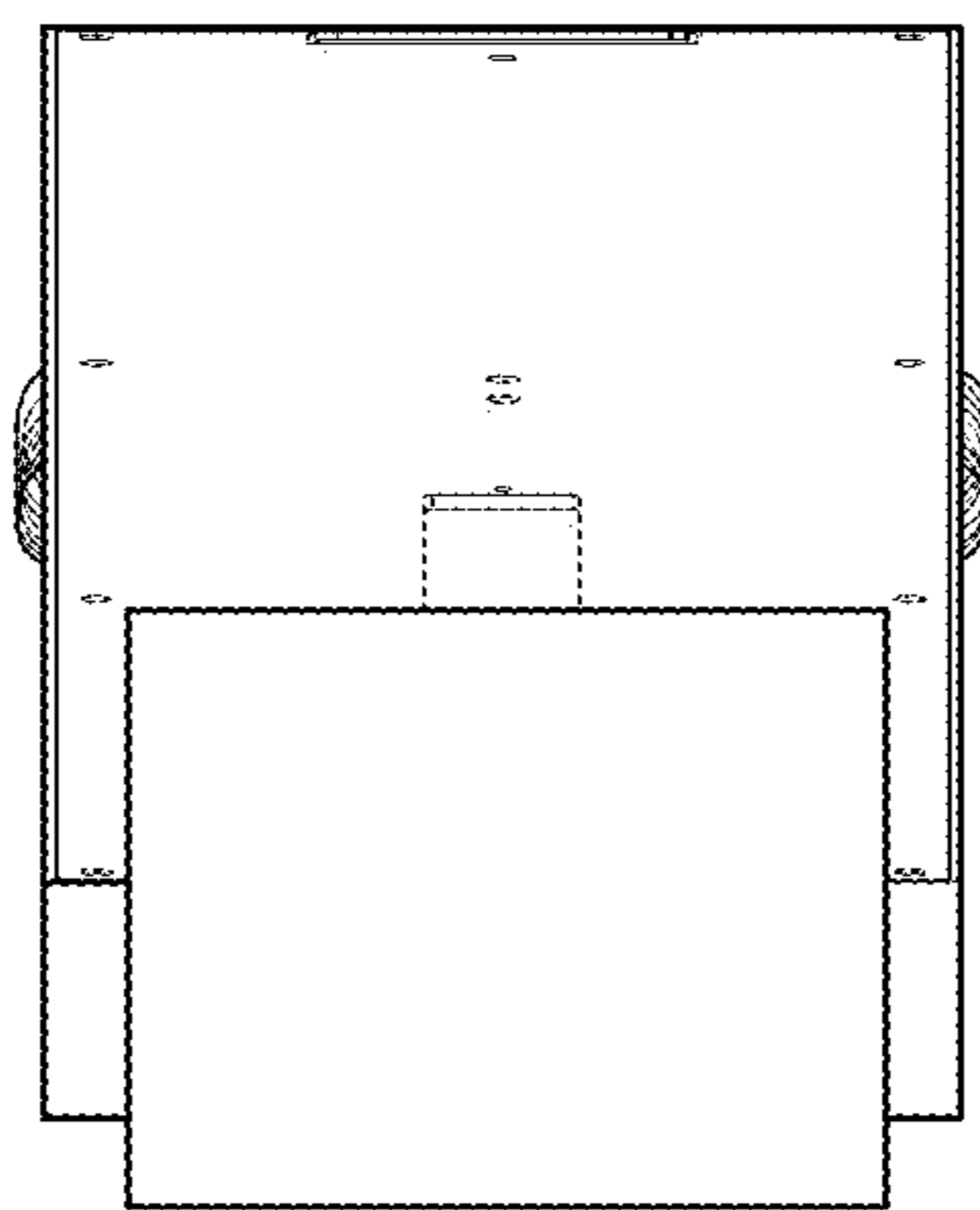

FIG. 7

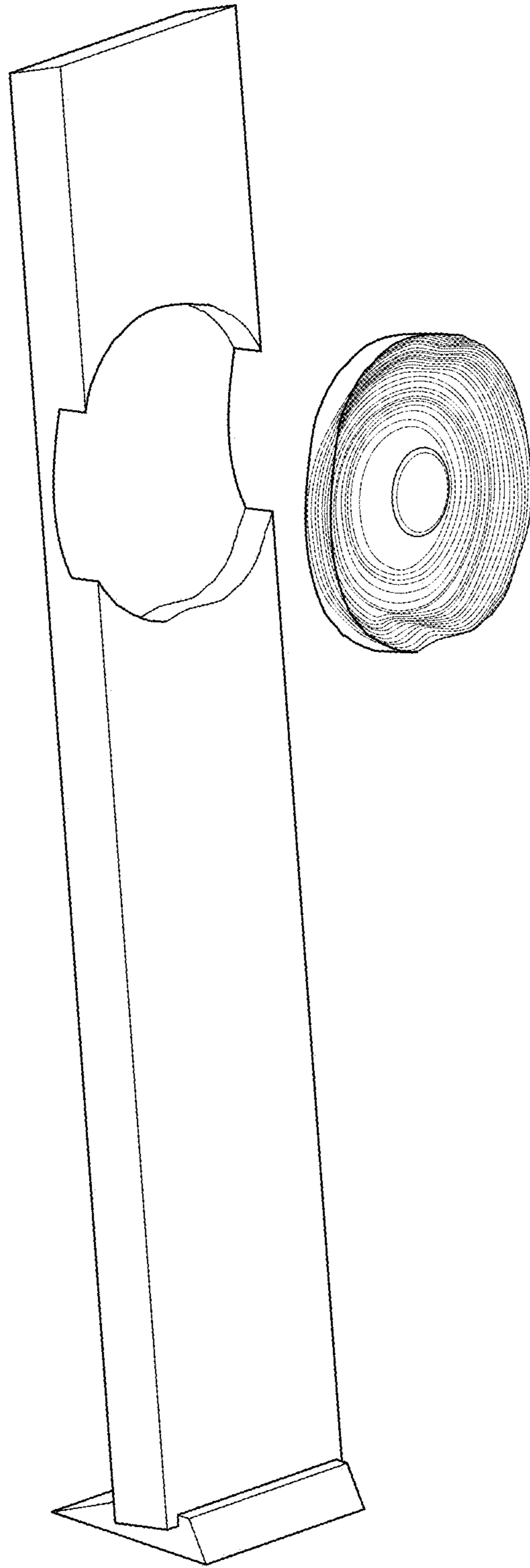

FIG. 8