



US00D893723S

(12) **United States Design Patent** (10) **Patent No.:** **US D893,723 S**
Bischof et al. (45) **Date of Patent:** **** Aug. 18, 2020**

(54) **PROSTHETIC**

(71) Applicant: **Otto Bock Healthcare Products GmbH**, Vienna (AT)

(72) Inventors: **Johannes Bischof**, Wiener Neustadt (AT); **Alice Frey**, Stockerau (AT); **Sandra Niederstrasser**, Duderstadt (DE); **Walter Lunzer**, Vienna (AT); **Markus Piller**, Vienna (AT); **Philipp Kampas**, Vienna (AT); **Sonja Wagner**, Vienna (AT)

(73) Assignee: **OTTO BOCK HEALTHCARE PRODUCTS GMBH**, Vienna (AT)

(**) Term: **15 Years**

(21) Appl. No.: **29/637,267**

(22) Filed: **Feb. 15, 2018**

(30) **Foreign Application Priority Data**

Aug. 18, 2017 (EP) 004154219

(51) **LOC (12) Cl.** **24-03**

(52) **U.S. Cl.**
USPC **D24/155**

(58) **Field of Classification Search**
USPC D24/155
CPC A61F 2/3859; A61F 2/38; A61F 2/389;
A61F 2/3886; A61F 2/60; A61F 2/06;
A61F 2/66; A61F 2/76; A61F 2310/00023
See application file for complete search history.

(56) **References Cited**

U.S. PATENT DOCUMENTS

D526,062 S * 8/2006 Harn D24/155
D674,898 S * 1/2013 Muhlenberend D24/155
D702,347 S * 4/2014 Noack D24/155
D732,167 S * 6/2015 Terleski D24/155

D732,168 S * 6/2015 Terleski D24/155
D785,177 S * 4/2017 Gonzalez D24/155
D795,434 S * 8/2017 Mille D24/155
2005/0154473 A1 * 7/2005 Bassett A61F 2/68
623/43

* cited by examiner

Primary Examiner — Charles D Hanson
(74) *Attorney, Agent, or Firm* — Andrew M. Calderon;
Roberts Calderon Safran & Cole, P.C.

(57) **CLAIM**

We claim the ornamental design for a prosthetic, as shown and described.

DESCRIPTION

FIG. 1 is a front view of a prosthetic showing our new design;
FIG. 2 is a rear view thereof;
FIG. 3 is a first side view thereof;
FIG. 4 is a top view thereof;
FIG. 5 is a perspective view thereof;
FIG. 6 is a second side view thereof;
FIG. 7 is a bottom view thereof;
FIG. 8 is a front view thereof, in a second position;
FIG. 9 is a rear view thereof;
FIG. 10 is a first side view thereof;
FIG. 11 is a top view thereof;
FIG. 12 is a perspective view thereof;
FIG. 13 is a second side view thereof; and,
FIG. 14 is a bottom view thereof.

Applicant expressly reserves the right to modify FIGS. 1-14 to show in solid lines any the features shown in FIGS. 1-14 in dashed-lines; and to show in dashed-lines any the features shown in FIGS. 1-14 in solid lines. Any subject matter shown in dashed lines, and any surfaces of the design not shown, including interior surfaces, form no part of the claimed invention.

1 Claim, 14 Drawing Sheets

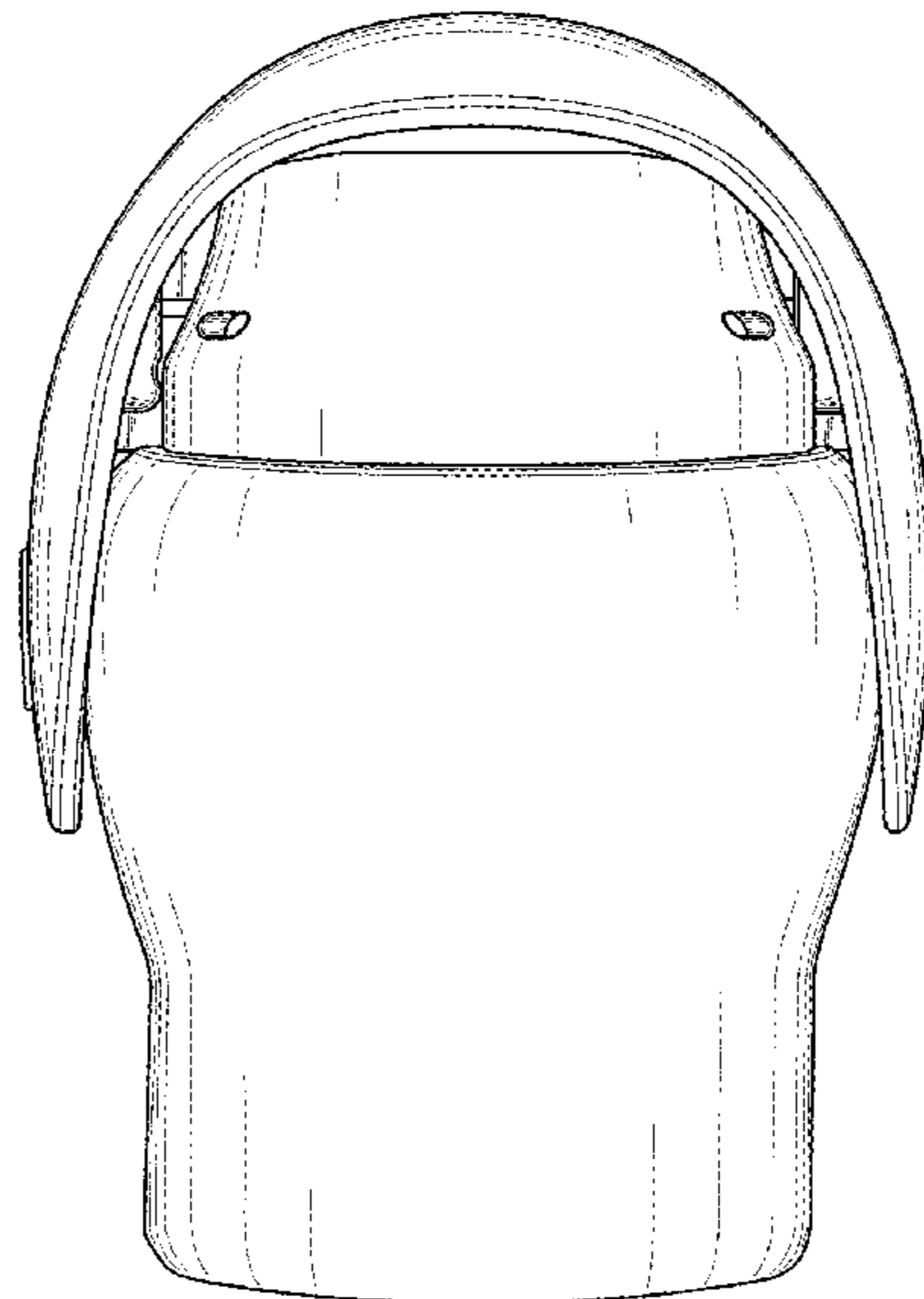

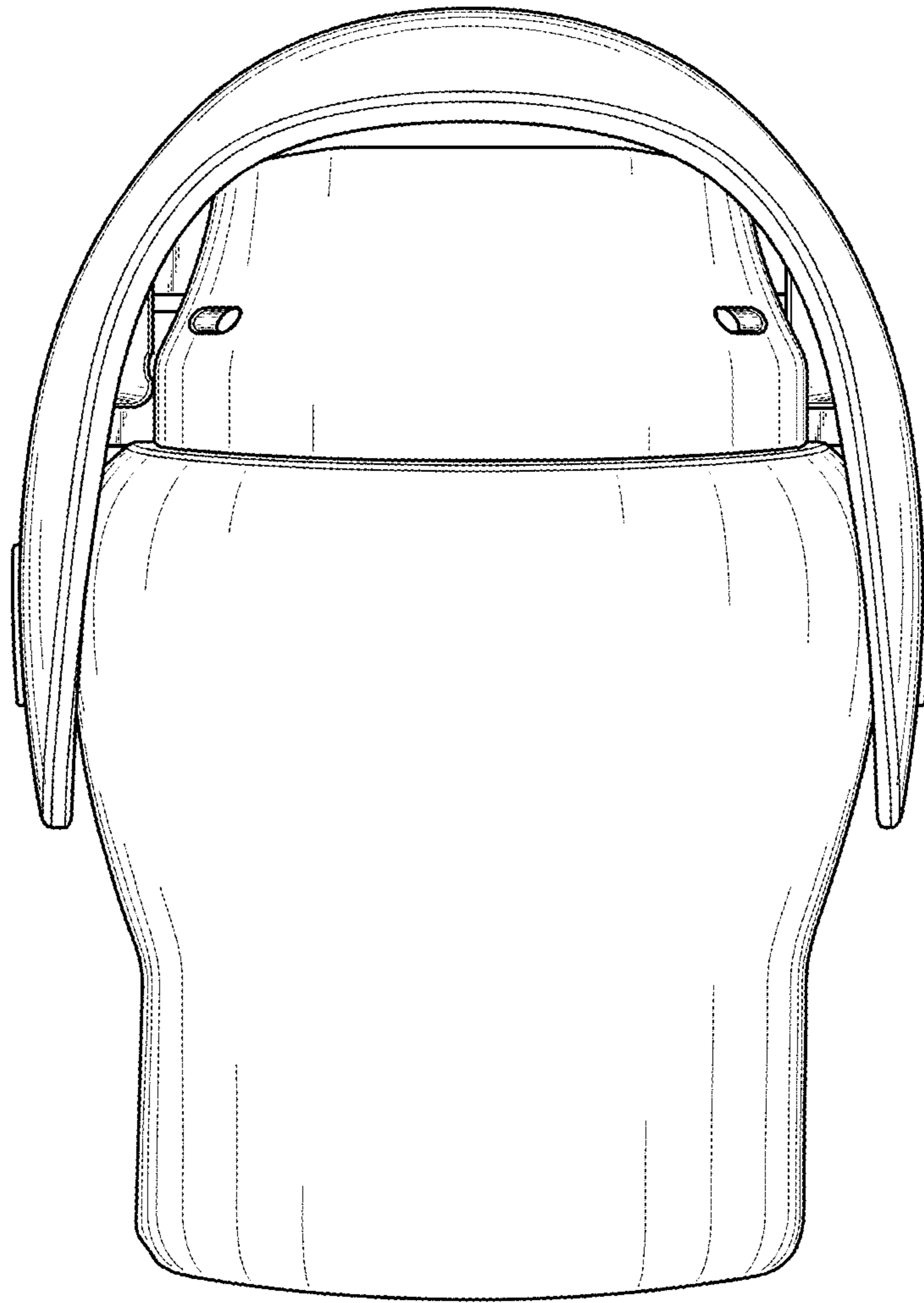

FIG. 1

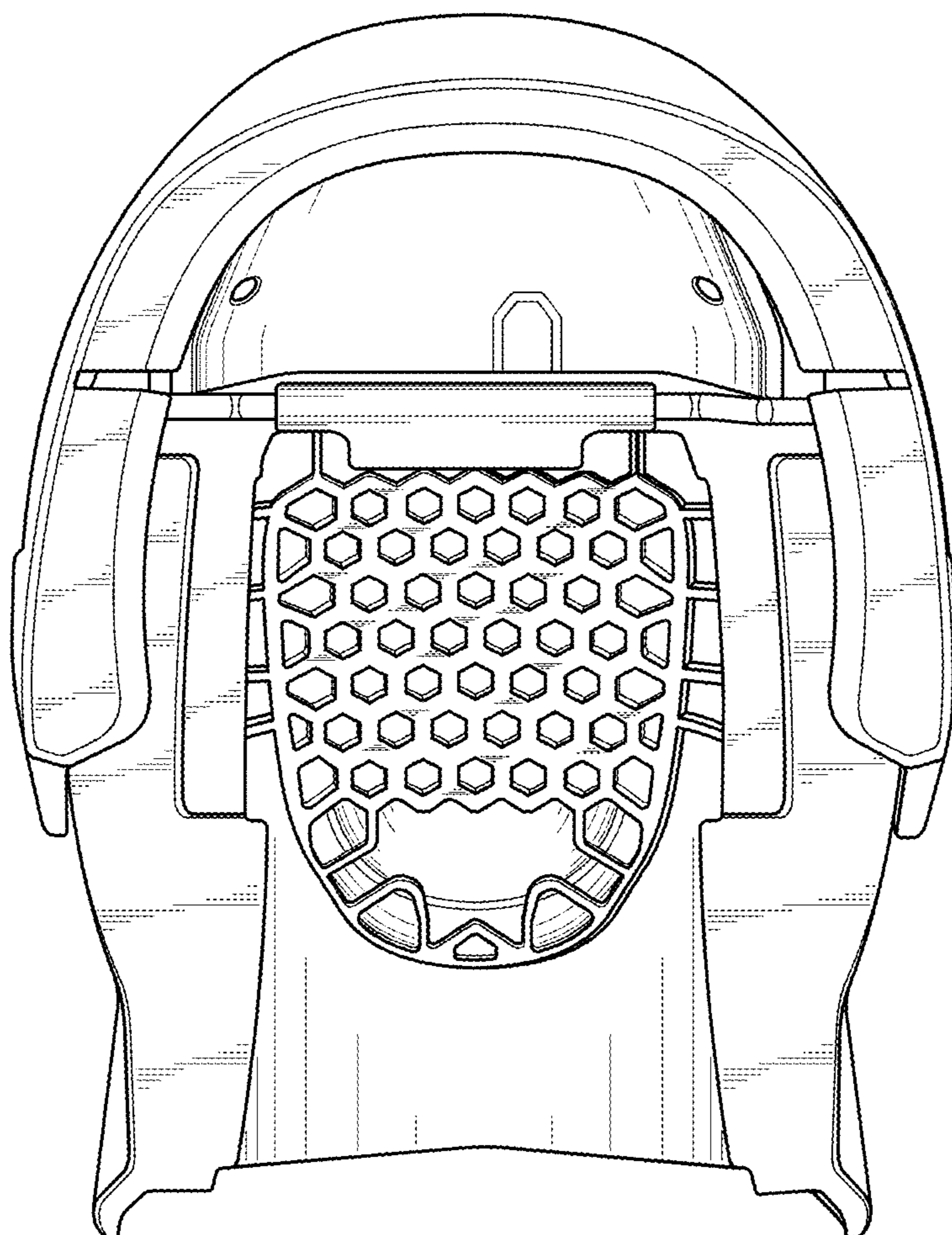

FIG. 2

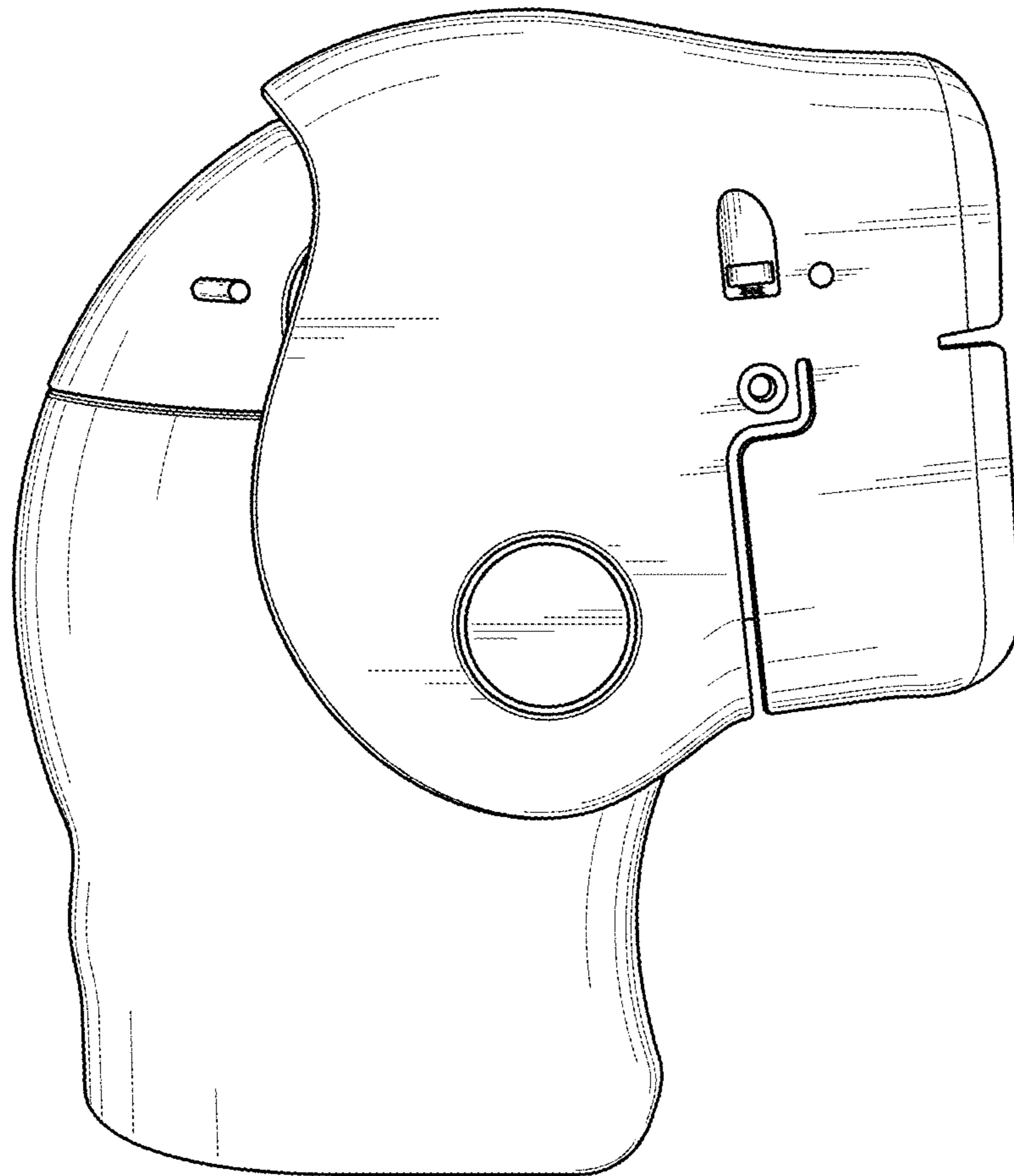

FIG. 3

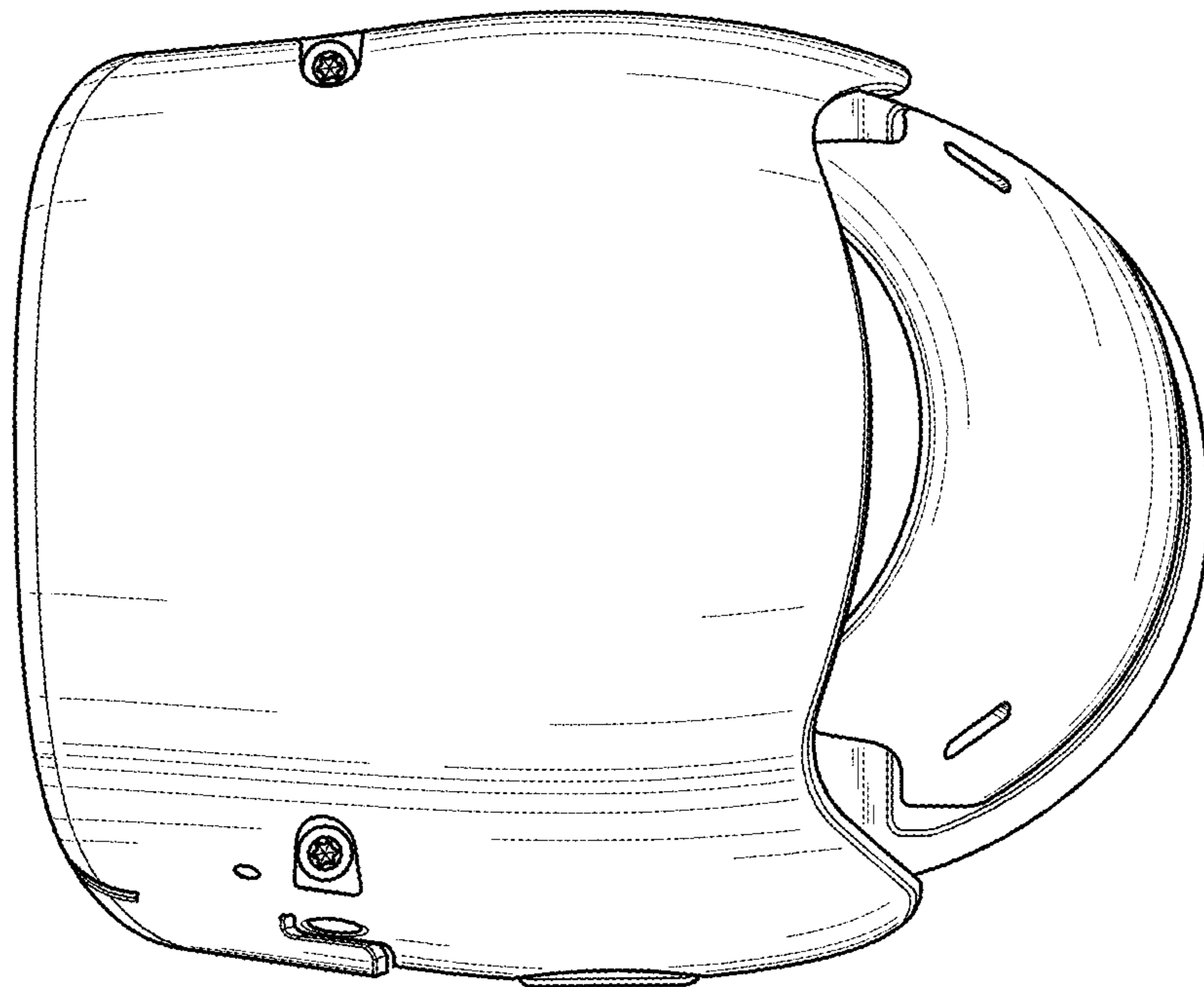

FIG. 4

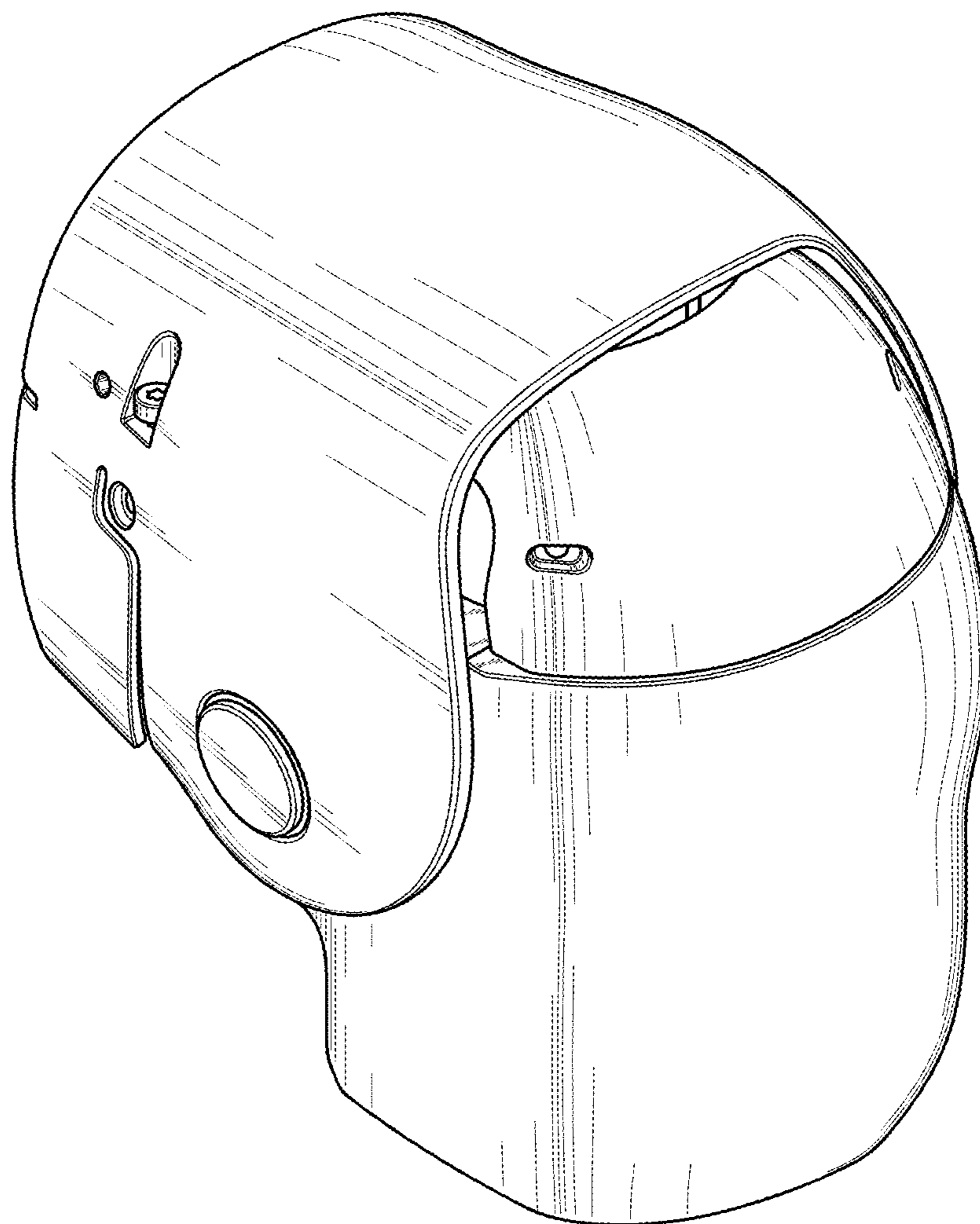

FIG. 5

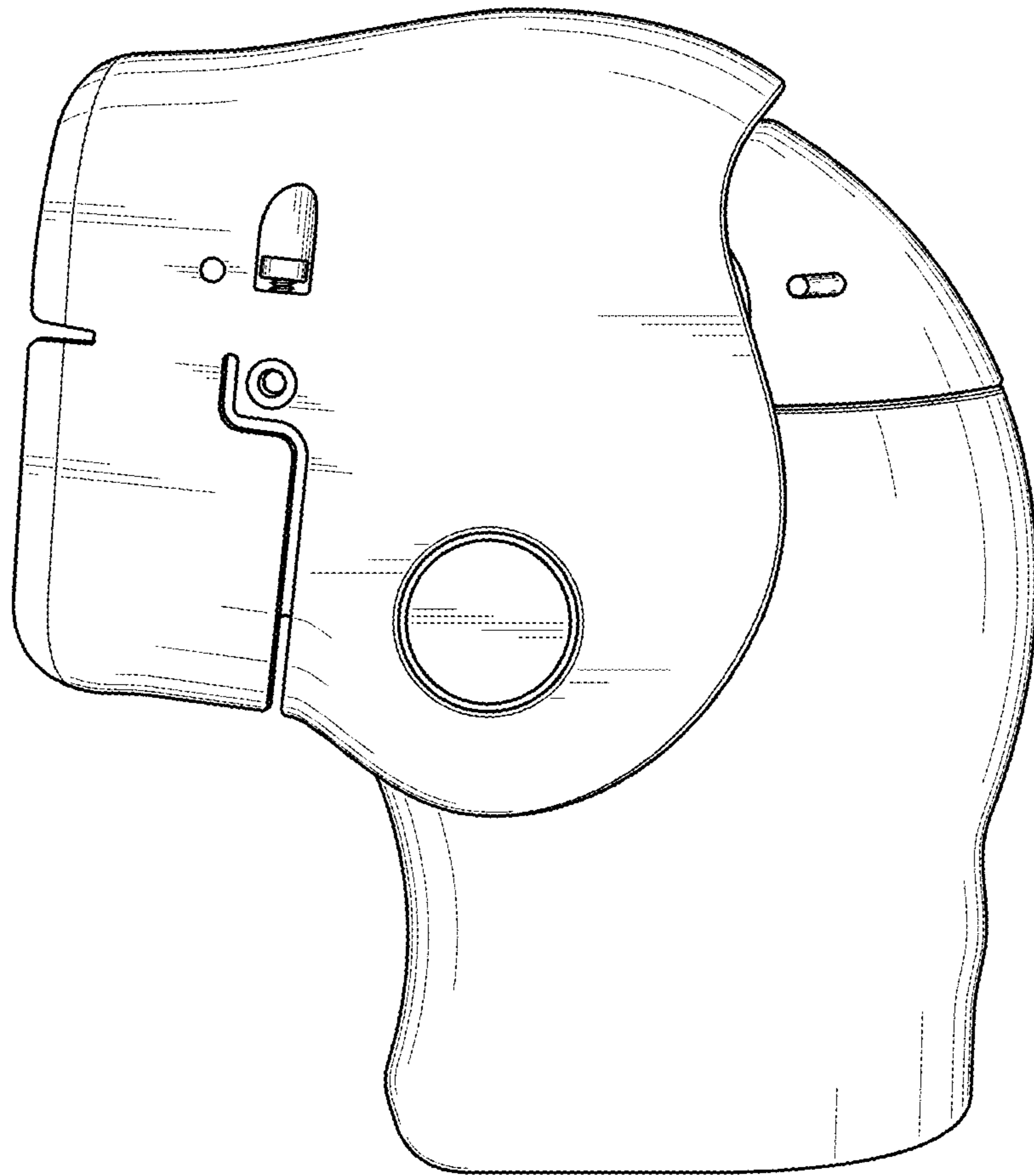

FIG. 6

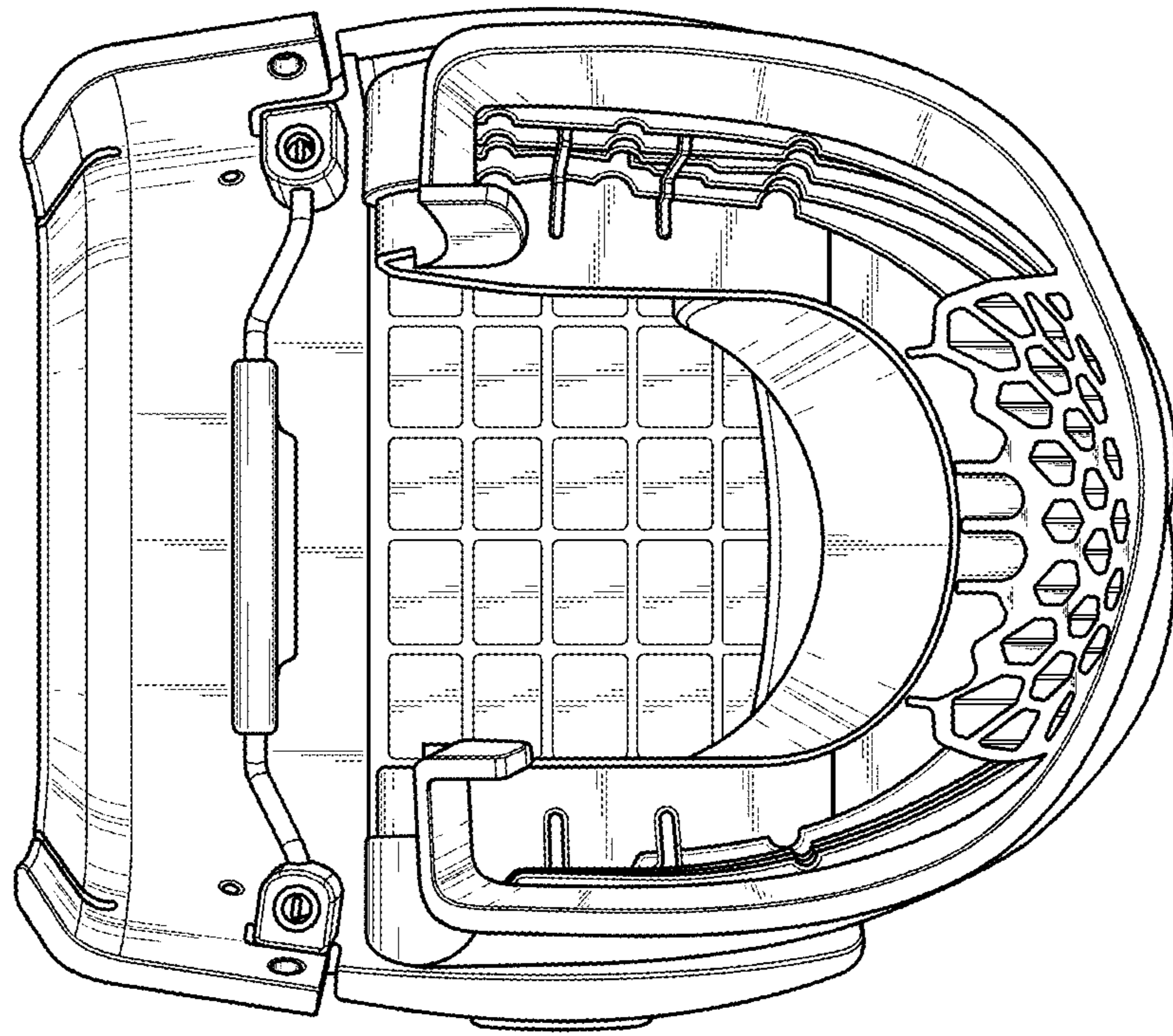

FIG. 7

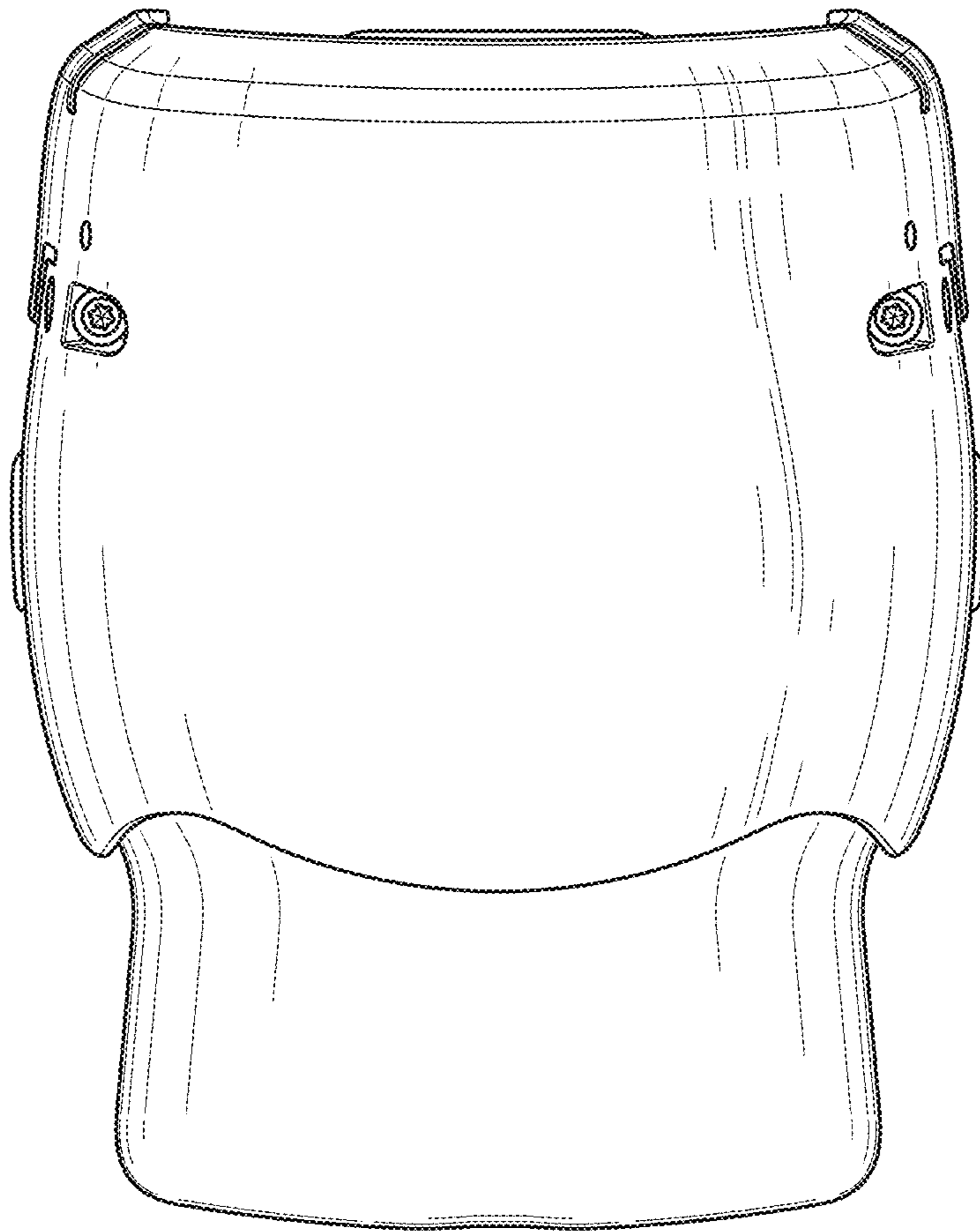

FIG. 8

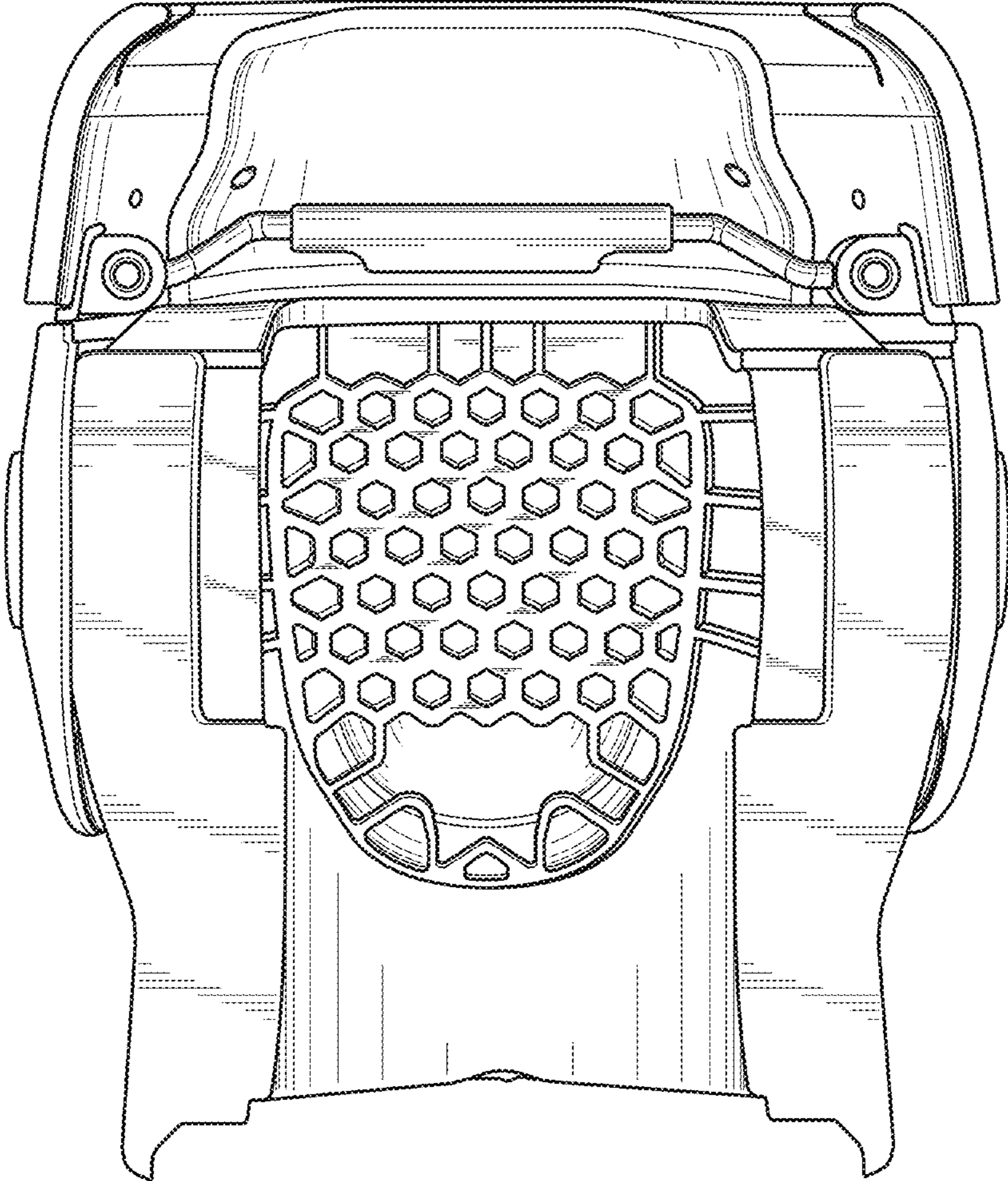

FIG. 9

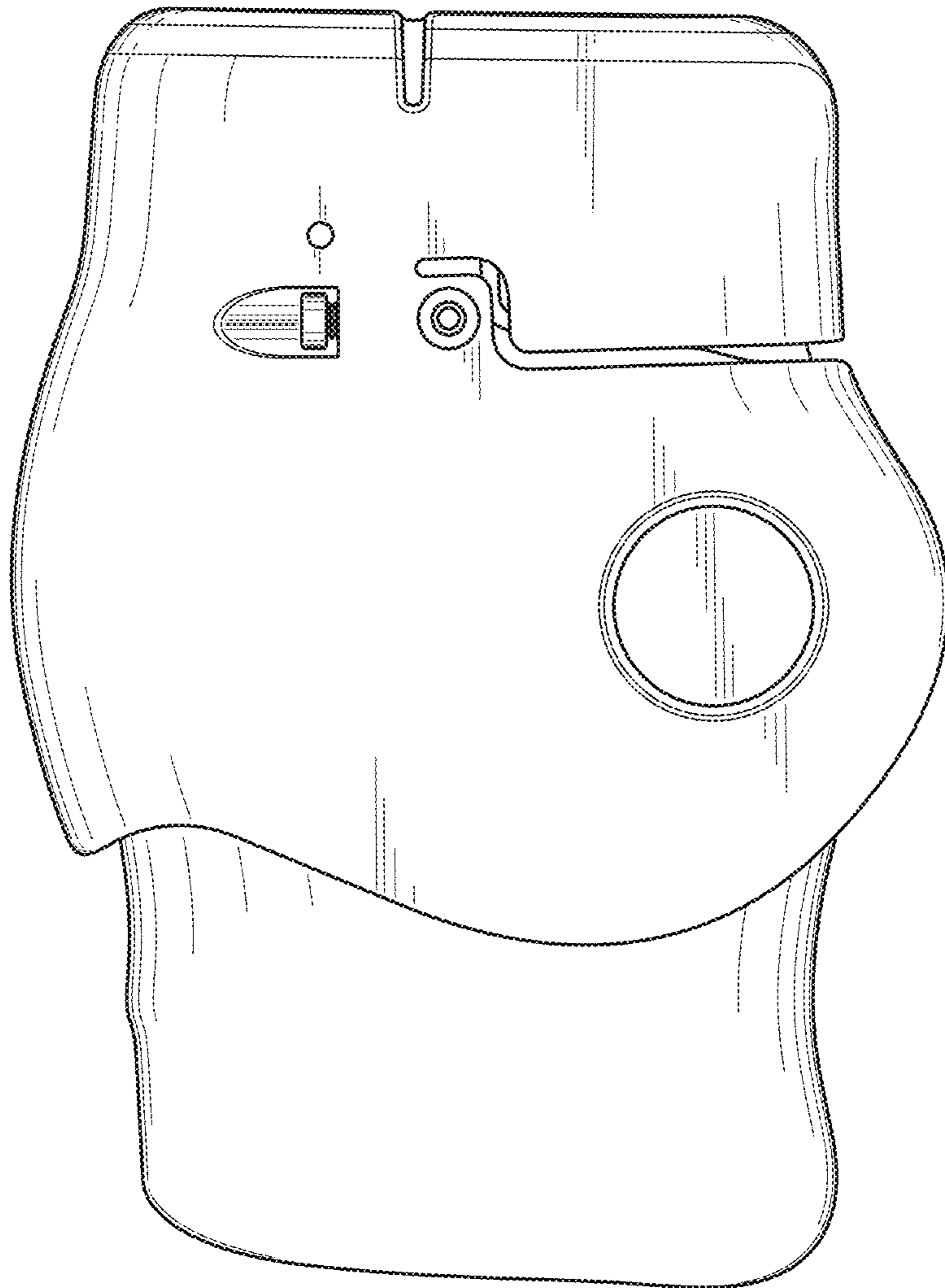

FIG. 10

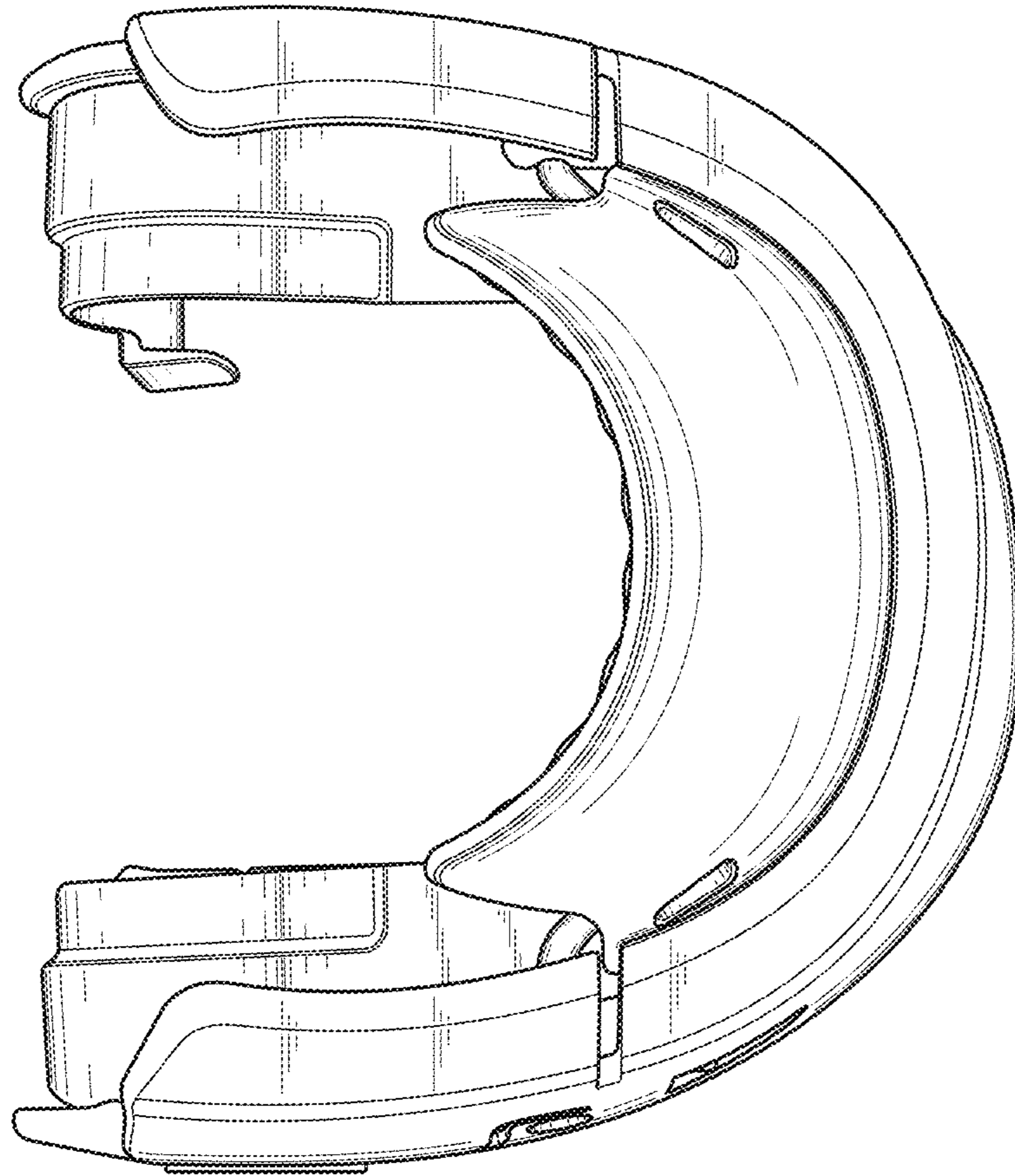

FIG. 11

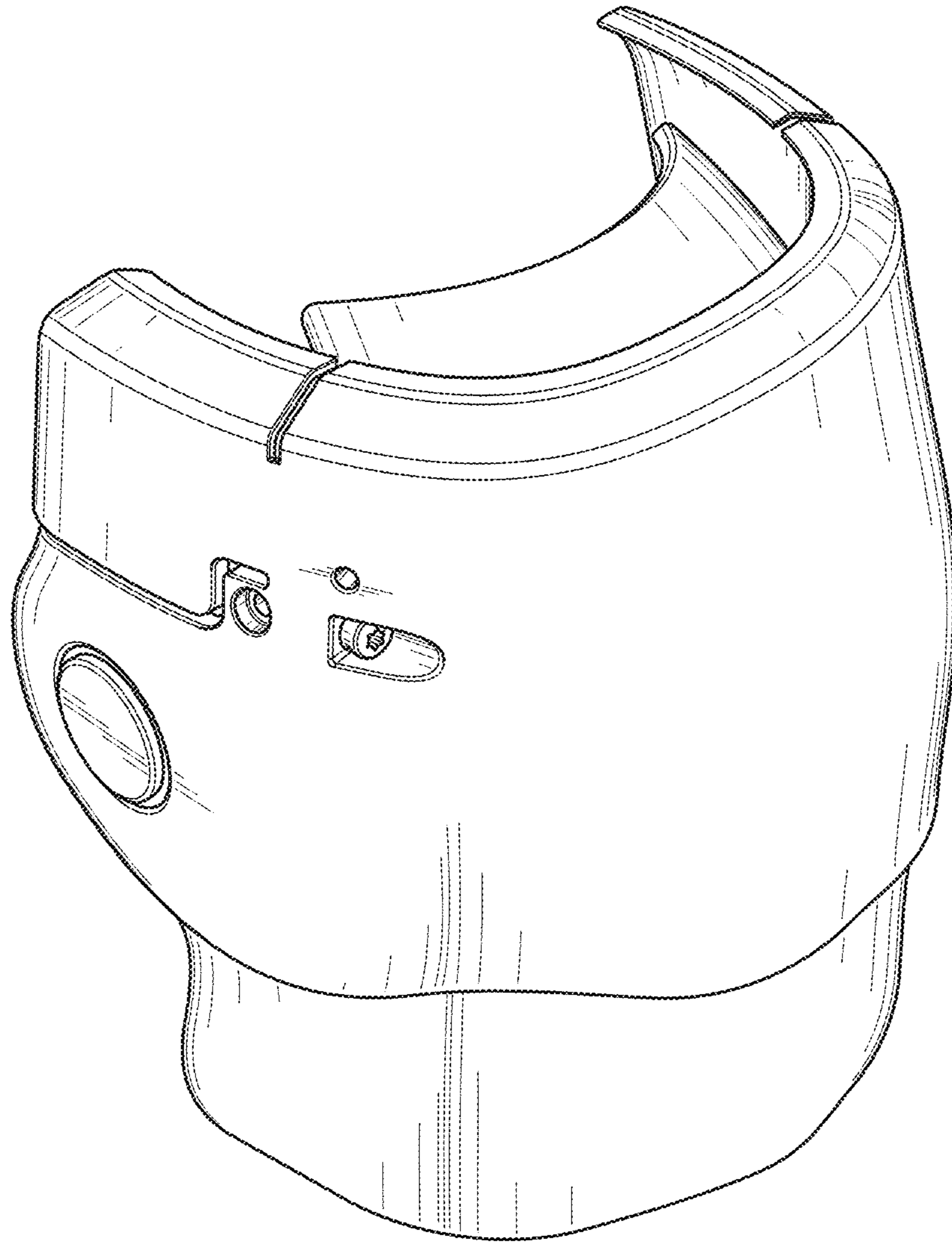

FIG. 12

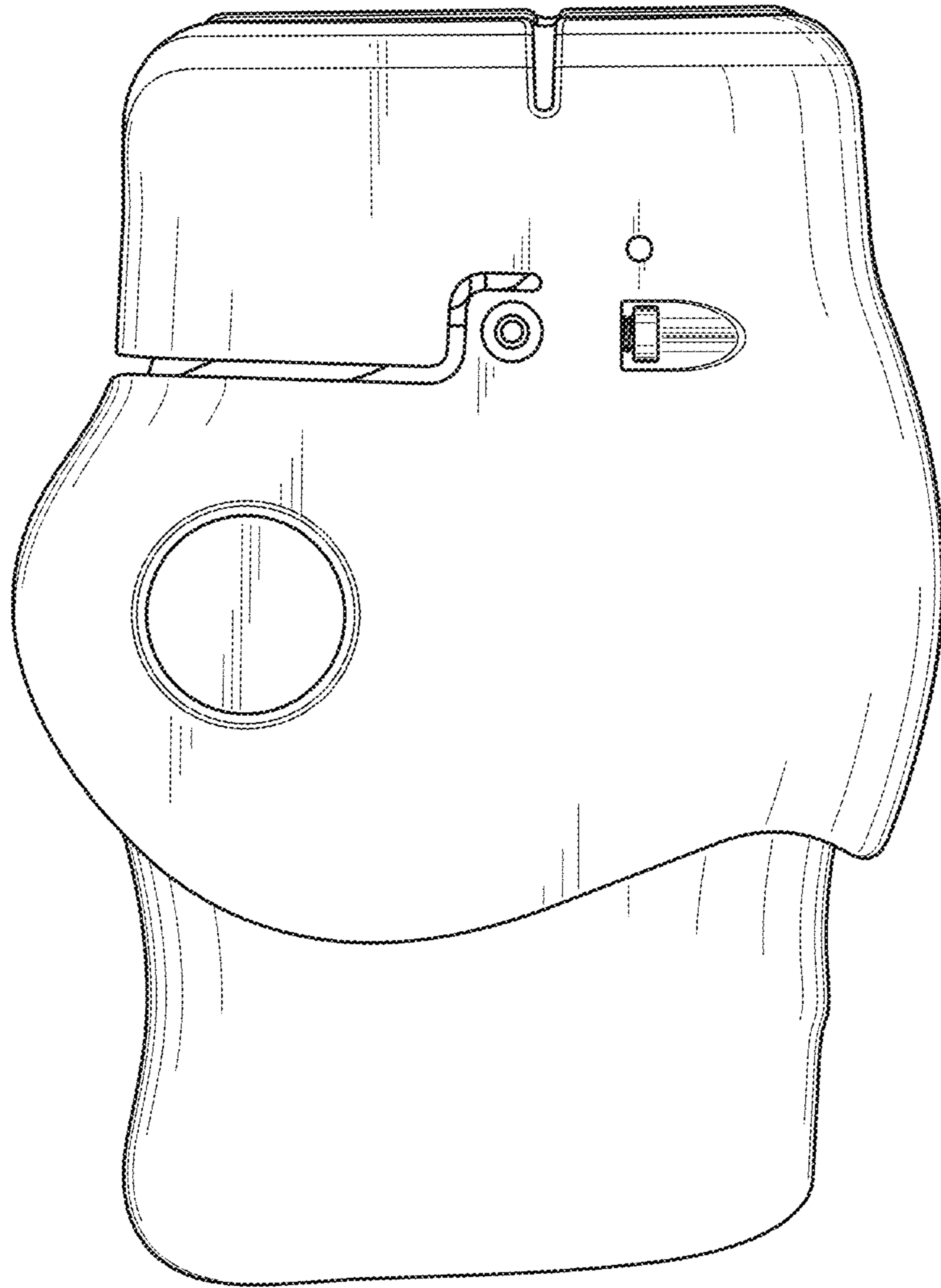

FIG. 13

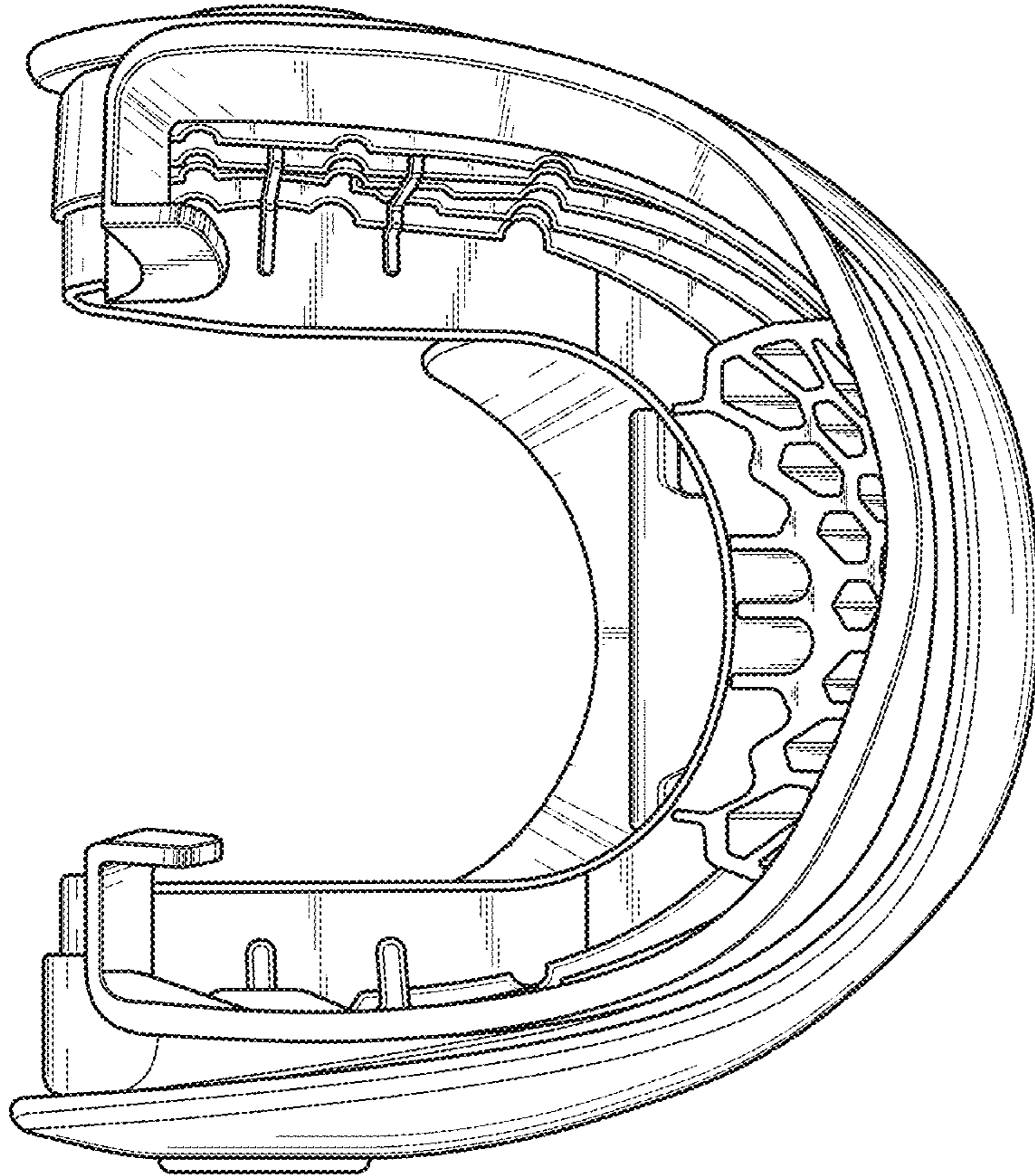

FIG. 14