



US00D893628S

(12) **United States Design Patent** (10) **Patent No.:** **US D893,628 S**
Thoeni et al. (45) **Date of Patent:** **** Aug. 18, 2020**

(54) **GAMING MACHINE HAVING DUAL BILL ACCEPTORS**
(71) Applicant: **IGT**, Las Vegas, NV (US)
(72) Inventors: **Stewart Thoeni**, Reno, NV (US);
James Vasquez, Carson City, NV (US);
Steven P. McGahn, Reno, NV (US);
Brian K. Baker, Reno, NV (US)
(73) Assignee: **IGT**, Las Vegas, NV (US)
(**) Term: **15 Years**
(21) Appl. No.: **29/664,398**
(22) Filed: **Sep. 25, 2018**
(51) **LOC (12) Cl.** **21-01**
(52) **U.S. Cl.**
USPC **D21/300**
(58) **Field of Classification Search**
USPC D21/300, 323, 324, 325, 326, 327, 328,
D21/329, 330, 331, 332, 333, 334, 335,
D21/336, 337, 369, 370, 371, 372, 373,
D21/374; D99/33, 34, 35, 36; D14/125,
D14/126, 133, 203.7, 203.8, 217, 300,
D14/301, 302, 305, 307, 334, 496, 511
CPC G07F 17/3283; G07F 17/3204
See application file for complete search history.

(56) **References Cited**
U.S. PATENT DOCUMENTS
D77,825 S * 2/1929 Fey D21/300
D245,359 S * 8/1977 Wilke D21/312
5,813,914 A 9/1998 McKay et al.
6,688,984 B2 2/2004 Cole
D508,961 S * 8/2005 Gatto D21/325
6,997,810 B2 2/2006 Cole
(Continued)

OTHER PUBLICATIONS
"23 inch double screen cabinet", posted date unavailable[online],
[retrieved Sep. 3, 2019]. Retrieved from internet, https://www.taiwantrade.com/product/23-double-screen-slant-top-gaming-machine-for-casino-gaming-center-1293546.html#.*

Primary Examiner — Sandra S Snapp
Assistant Examiner — Mehri F Bajoul
(74) *Attorney, Agent, or Firm* — Neal, Gerber & Eisenberg LLP

(57) **CLAIM**
The ornamental design for a gaming machine having dual bill acceptors, as shown and described.

DESCRIPTION
This application is related to the following commonly owned co-pending patent applications: U.S. application Ser. No. 29/660,021, entitled "Bartop Gaming Console,"; U.S. application Ser. No. 16/140,839, entitled "Electronic Gaming Machine With Multiple Bill Validators,"; and U.S. application Ser. No. 29/664,402, entitled "Bar Top Gaming Machine Having Dual Bill Acceptors,".
FIG. 1 is a front perspective view of a gaming machine having dual bill acceptors of our new design.
FIG. 2 is a front view of the gaming machine having dual bill acceptors of FIG. 1.
FIG. 3 is a rear view of the gaming machine having dual bill acceptors of FIG. 1.
FIG. 4 is a left side view of the gaming machine having dual bill acceptors of FIG. 1.
FIG. 5 is a right side view of the gaming machine having dual bill acceptors of FIG. 1.
FIG. 6 is a top view of the gaming machine having dual bill acceptors of FIG. 1; and,
FIG. 7 is a bottom view of the gaming machine having dual bill acceptors of FIG. 1.
The broken lines shown in the drawings depict portions of the gaming machine having dual bill acceptors that form no part of the claimed design.

1 Claim, 7 Drawing Sheets

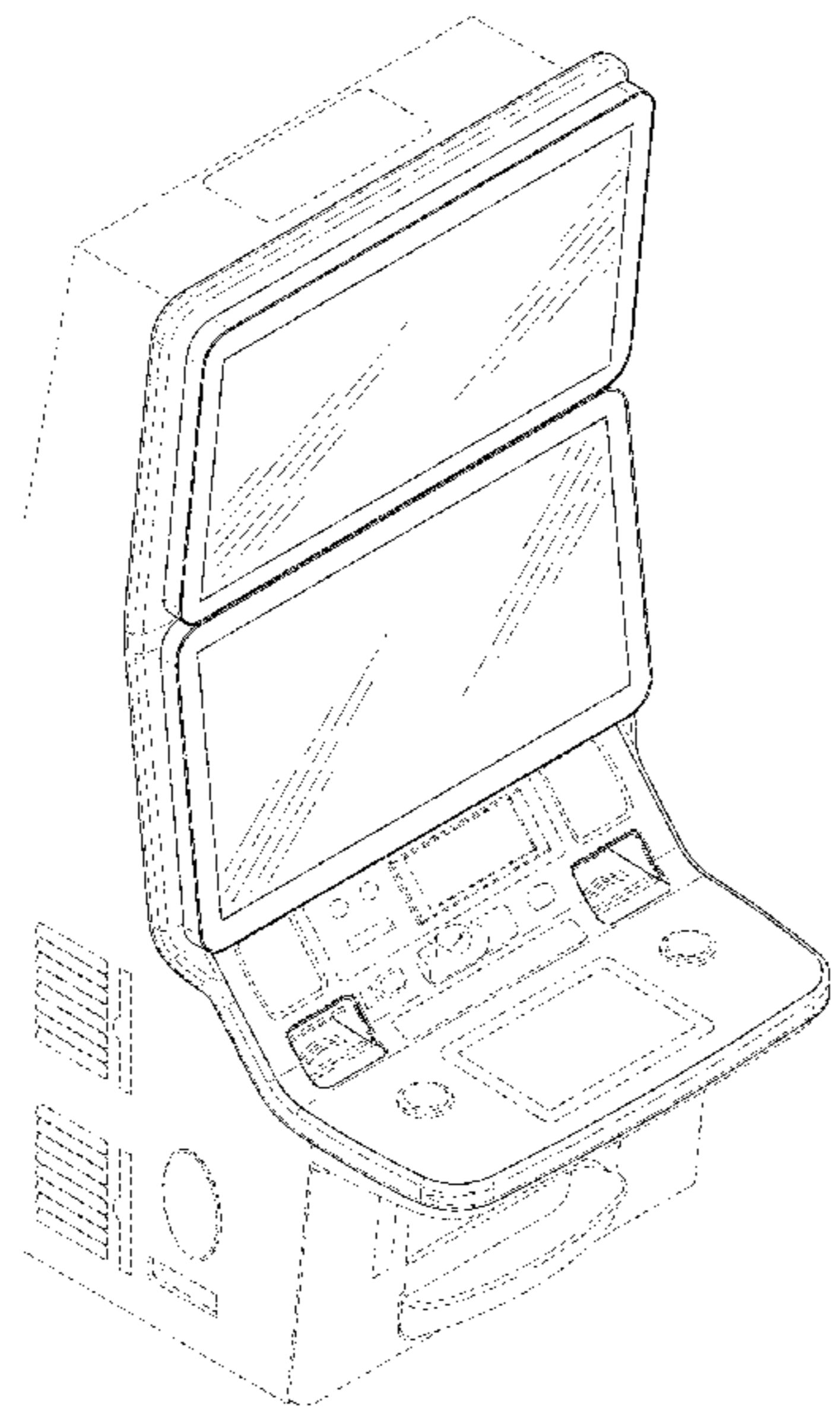

(56)

References Cited

U.S. PATENT DOCUMENTS

D539,854 S *	4/2007	Luciano	D21/369	8,864,135 B2	10/2014	Baerlocher et al.	
7,267,613 B2	9/2007	Cole			8,870,663 B2	10/2014	Cole	
D559,917 S	1/2008	Cole			D721,766 S *	1/2015	Ferrazoli D21/370
D564,600 S *	3/2008	Greenberg	D21/370	D721,767 S *	1/2015	Ferrazoli D21/370
7,396,282 B2	7/2008	Gauselmann			D730,993 S *	6/2015	Castro D21/370
D596,678 S *	7/2009	Myers	D21/370	D740,887 S *	10/2015	Randazzo D21/370
D599,858 S *	9/2009	Lesley	D21/370	9,443,385 B2	9/2016	Adiraju et al.	
D605,231 S *	12/2009	Hashimoto	D21/325	9,508,220 B2	11/2016	Walker et al.	
D615,598 S *	5/2010	McComb	D21/370	D803,324 S *	11/2017	Bussey D21/370
7,993,198 B2	8/2011	Walker et al.			9,824,523 B2	11/2017	Cannon et al.	
8,033,902 B2	10/2011	Wells et al.			D818,048 S *	5/2018	Calhoun D21/369
8,272,947 B2	9/2012	Gagner et al.			9,990,807 B2 *	6/2018	Leger G07F 17/3283
D674,023 S *	1/2013	Seelig	D21/369	D842,930 S *	3/2019	Johnson D21/369
D684,216 S *	6/2013	Terpstra	D21/370	D854,620 S *	7/2019	Yeh D21/369
D685,435 S *	7/2013	Hohman	D21/370	D854,621 S *	7/2019	Calhoun D21/369
D697,558 S *	1/2014	Myers	D21/325	D858,641 S *	9/2019	Legras D21/370
D704,273 S *	5/2014	Chudek	D21/369	2009/0111573 A1	4/2009	Iddings	
					2009/0221375 A1	9/2009	Luciano, Jr. et al.	
					2009/0233681 A1	9/2009	Tsukahara	
					2014/0274252 A1	9/2014	Chun	

* cited by examiner

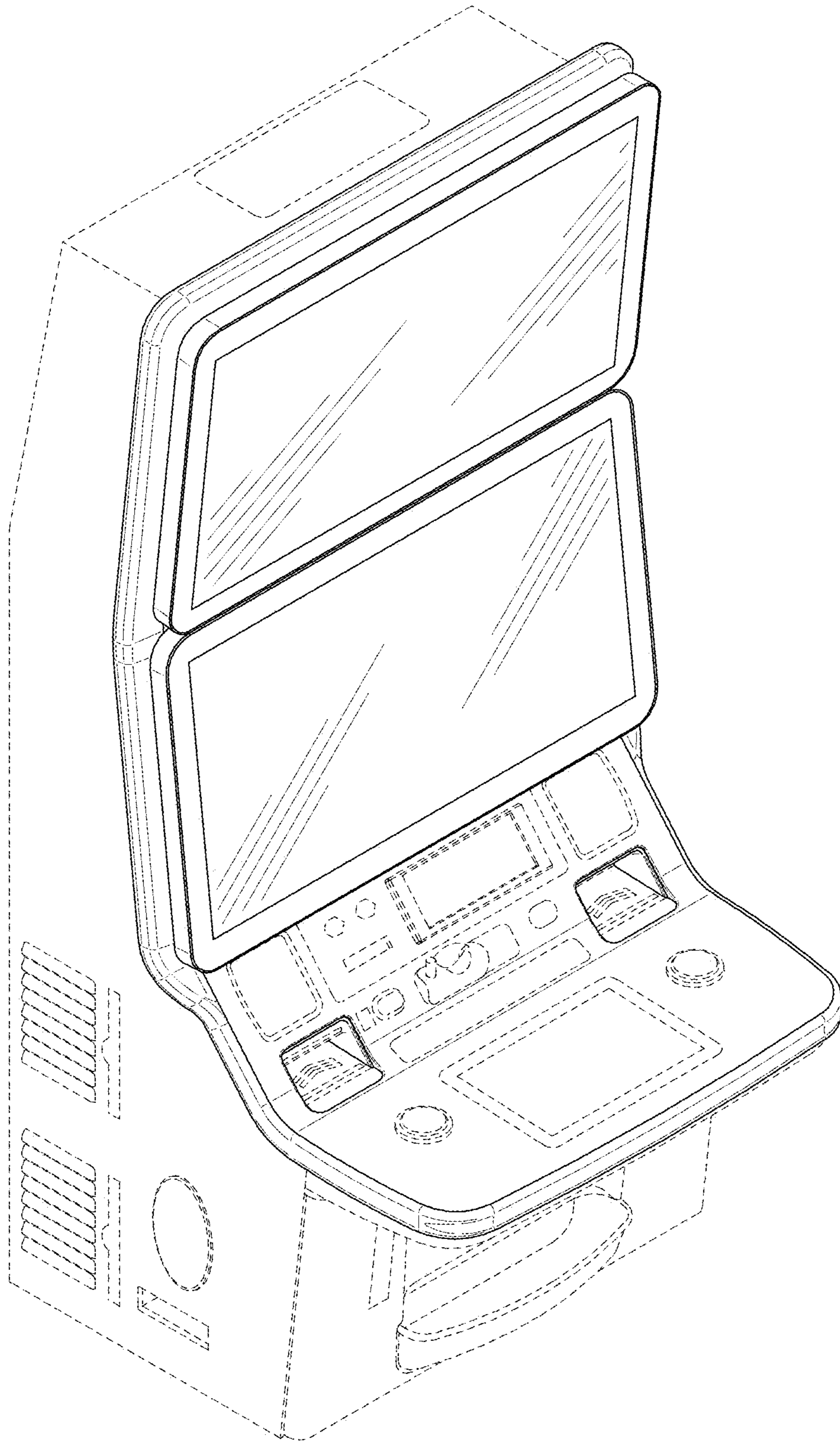

FIG. 1

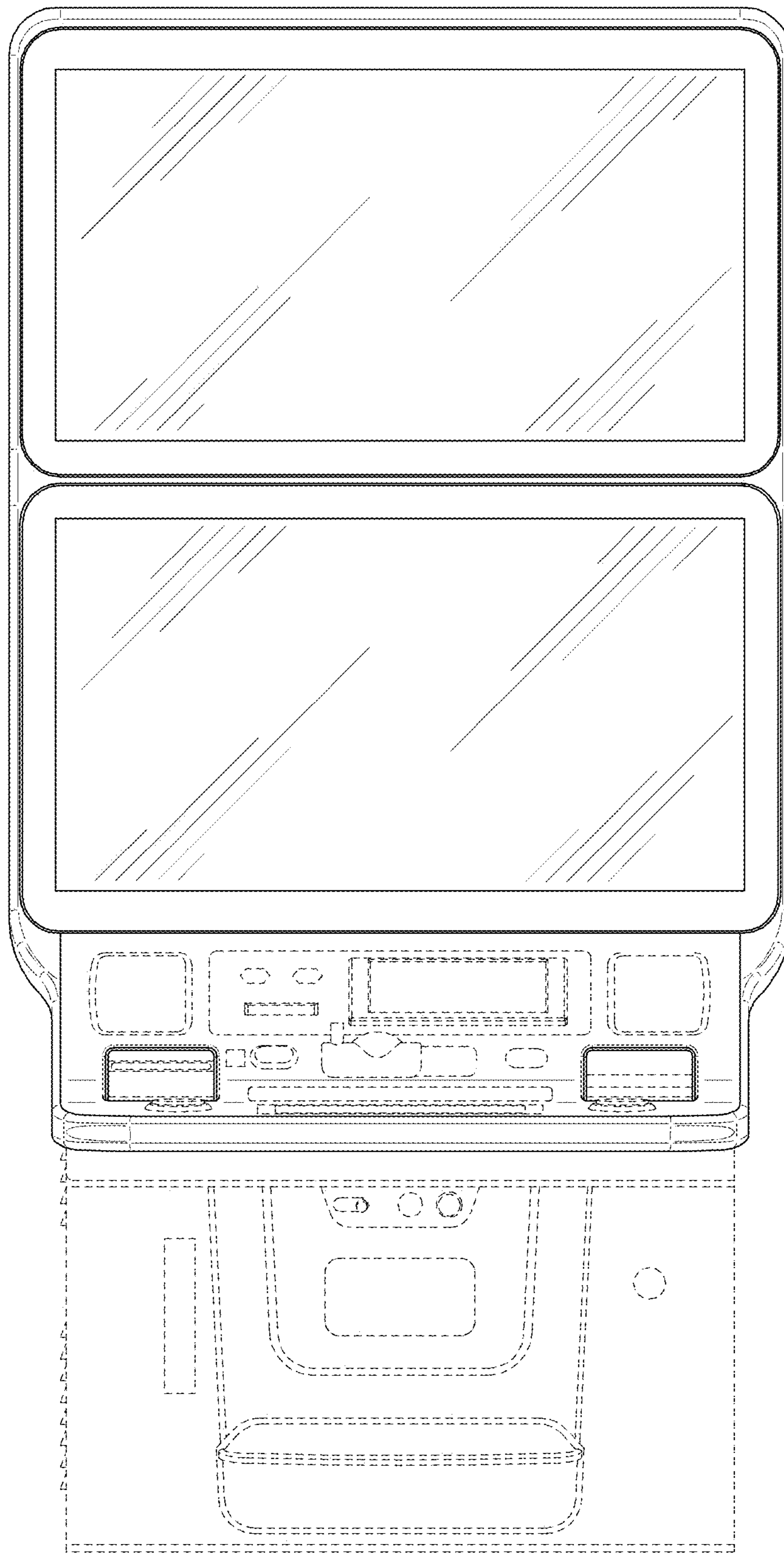

FIG. 2

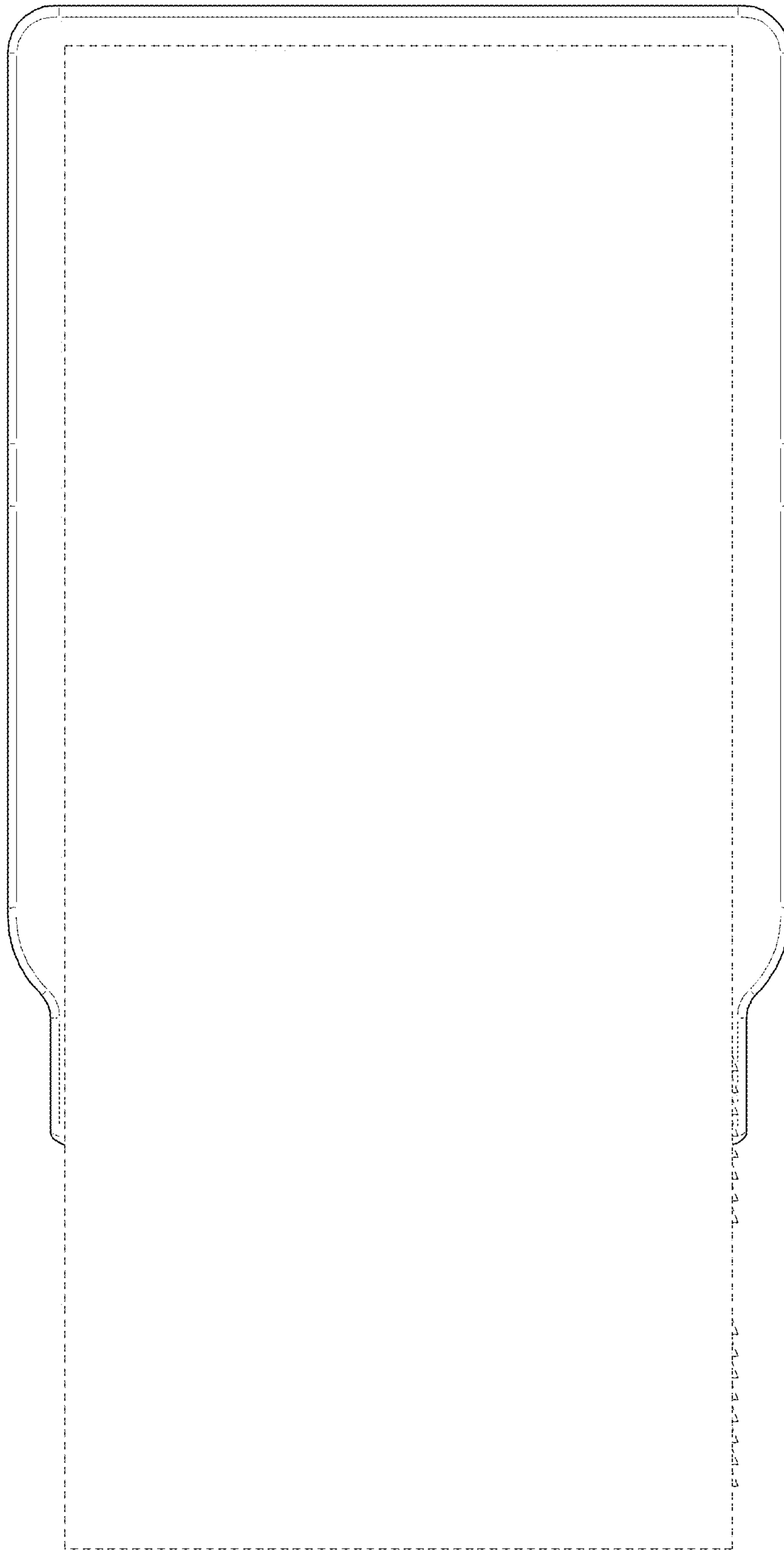

FIG. 3

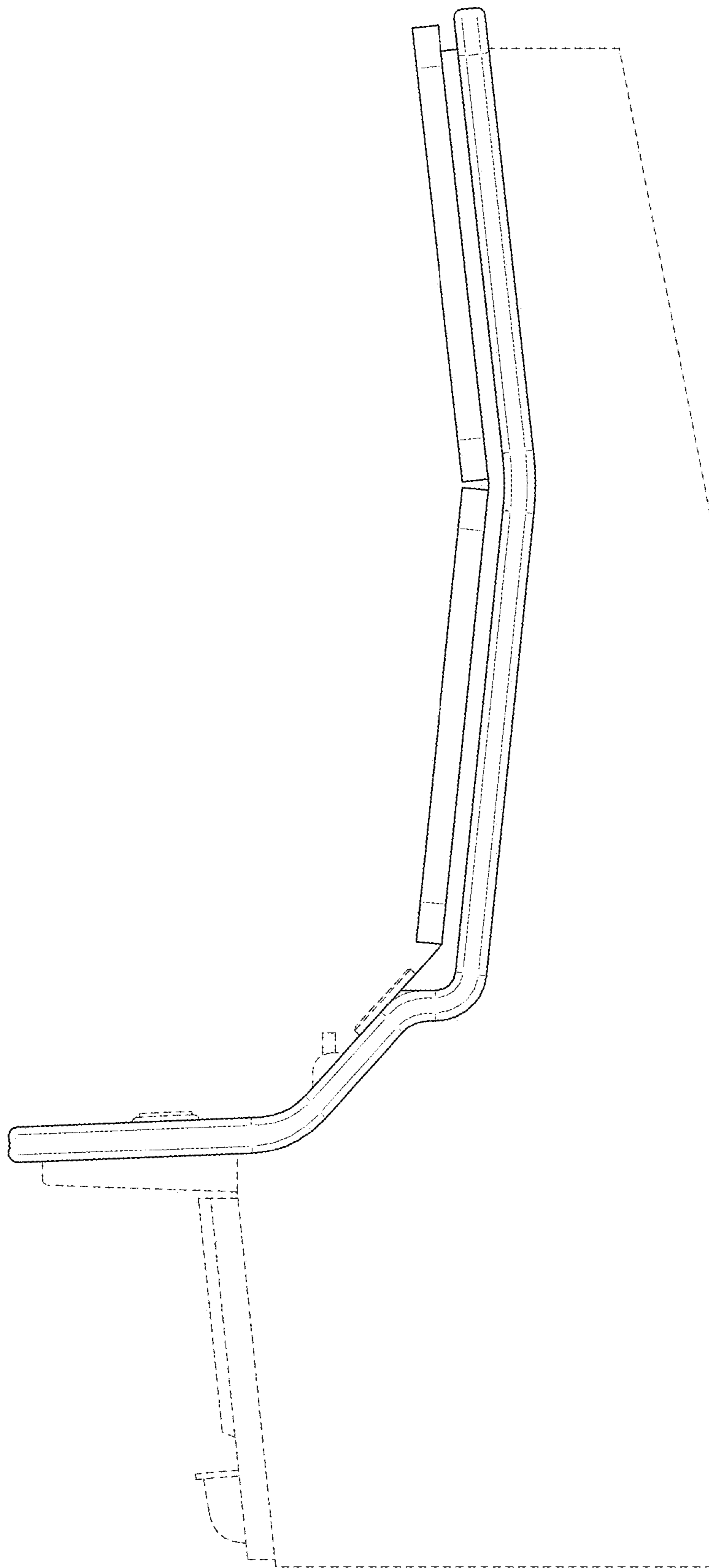

FIG. 4

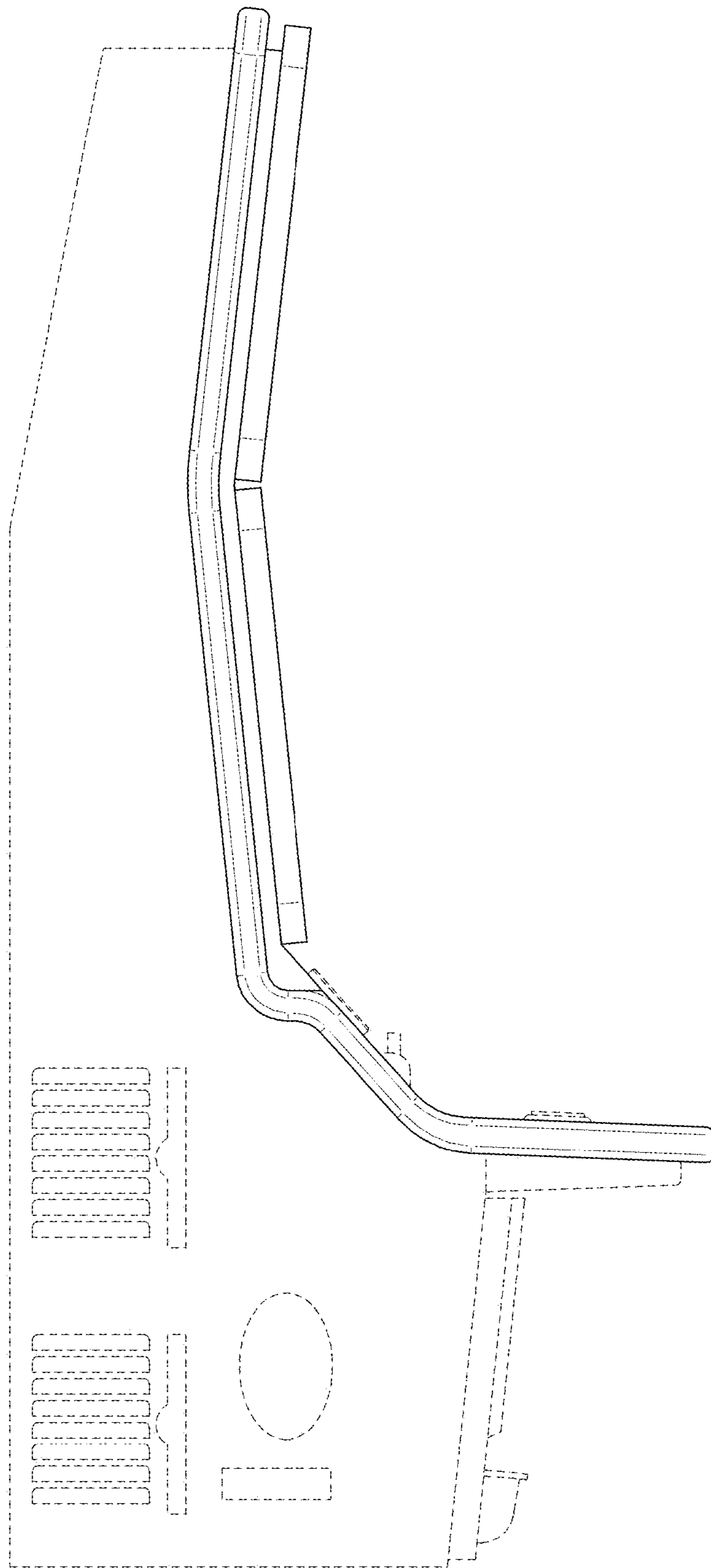

FIG. 5

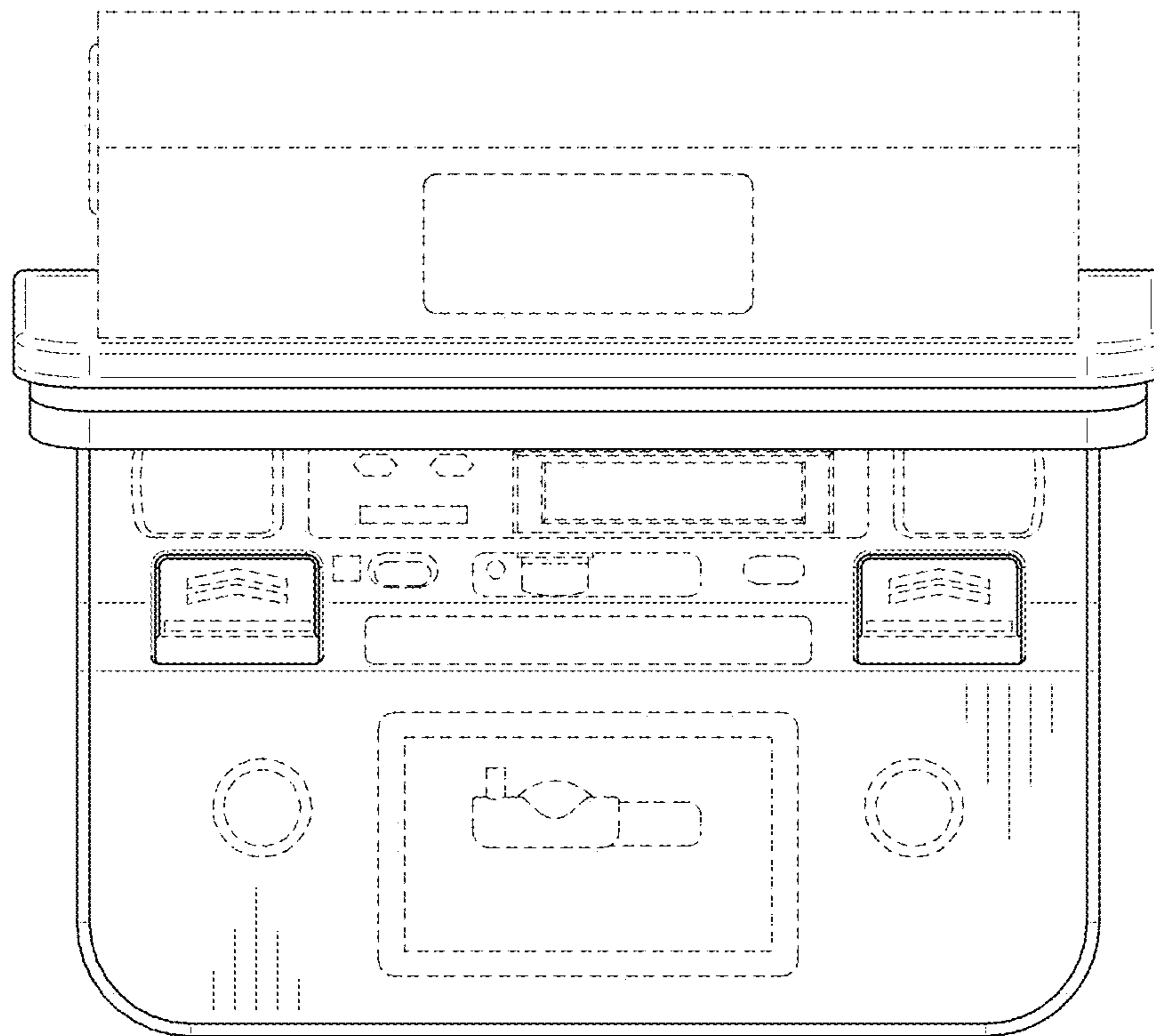

FIG. 6

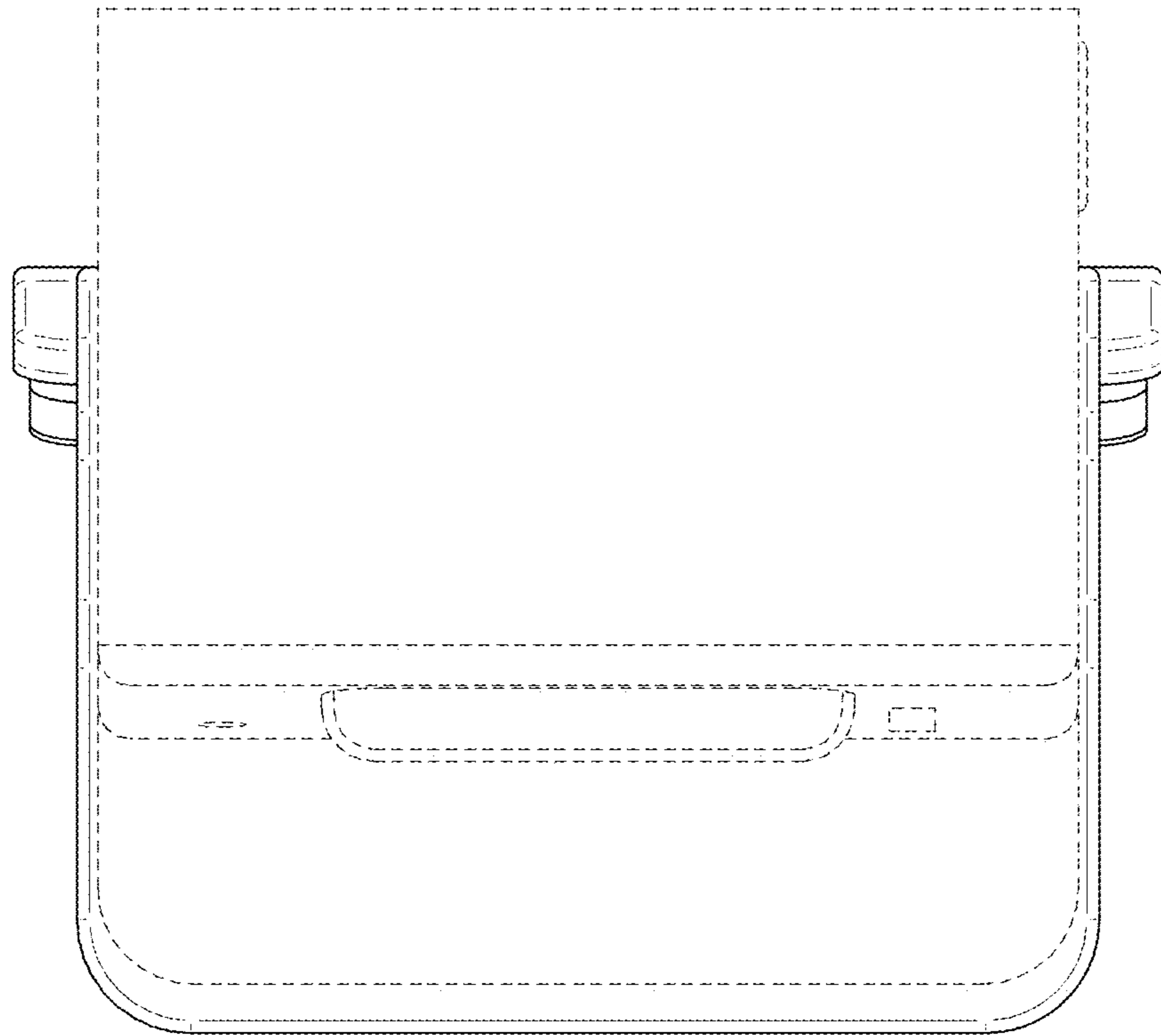

FIG. 7