



US00D893599S

(12) **United States Design Patent** (10) **Patent No.:** **US D893,599 S**
Richtsmeier et al. (45) **Date of Patent:** **** Aug. 18, 2020**

(54) **PRINTER**
(71) Applicant: **Hewlett-Packard Development Company, L.P.**, Houston, TX (US)
(72) Inventors: **Dean Richtsmeier**, Boise, ID (US); **Haohua Zhu**, Shanghai (CN); **Shuangkun Zhu**, Shanghai (CN)
(73) Assignee: **Hewlett-Packard Development Company, L.P.**, Spring, TX (US)
(**) Term: **15 Years**
(21) Appl. No.: **29/636,943**
(22) Filed: **Feb. 13, 2018**
(51) **LOC (12) Cl.** **14-02**
(52) **U.S. Cl.**
USPC **D18/50**
(58) **Field of Classification Search**
USPC D18/55, 50, 53, 54, 56, 59, 36, 37, 38, D18/39, 40, 41, 45, 49; D14/301, 307, D14/121
CPC H04N 1/00204; H04N 1/00249; H04N 1/00278; G06K 15/12; G06K 15/14; B41J 3/00; B41J 3/28; B41J 3/445; B41J 3/46
See application file for complete search history.

D822,759 S * 7/2018 Yamamoto D18/50
D826,317 S * 8/2018 Villalobos D18/50
D827,022 S * 8/2018 Yamashita D18/50
D850,528 S * 6/2019 Gosselin D18/34.3

FOREIGN PATENT DOCUMENTS

WO D089239-001 * 8/2016

OTHER PUBLICATIONS

Digital Trends. Link: <https://www.digitaltrends.com/printer-reviews/hp-deskjet-3755-review/>. Apr. 3, 2017. HP DeskJet 3755 is the multifunction printer for the space challenged. (Year: 2017).*

* cited by examiner

Primary Examiner — Lauren D McVey

(74) *Attorney, Agent, or Firm* — HP Inc. Patent Department

(57) **CLAIM**

The ornamental design for a printer, as shown and described.

DESCRIPTION

FIG. 1 is a front, right-side perspective view of a printer in accordance with our new design;
FIG. 2 is a front elevation view thereof;
FIG. 3 is a rear elevation view thereof;
FIG. 4 is a right-side elevation view thereof;
FIG. 5 is a left-side elevation view thereof;
FIG. 6 is a top plan view thereof;
FIG. 7 is a bottom plan view thereof;
FIG. 8 is a rear, top, right-side perspective view thereof; and,
FIG. 9 is a rear, bottom, right-side perspective view thereof.
The broken lines immediately adjacent the shaded areas depict the bounds of the claimed design while all other broken lines are directed to environment. The broken lines form no part of the claimed design.

1 Claim, 8 Drawing Sheets

(56) **References Cited**
U.S. PATENT DOCUMENTS

D685,412 S * 7/2013 Jihoon D18/50
D685,413 S * 7/2013 Jihoon D18/50
D714,862 S * 10/2014 Kim D18/50
D715,852 S * 10/2014 So D18/50
D715,853 S * 10/2014 Kim D18/50
D744,028 S * 11/2015 Odachi D18/50
D744,584 S * 12/2015 Seki D18/50
D751,141 S * 3/2016 Minamide D18/50
D817,388 S * 5/2018 Wan D18/50

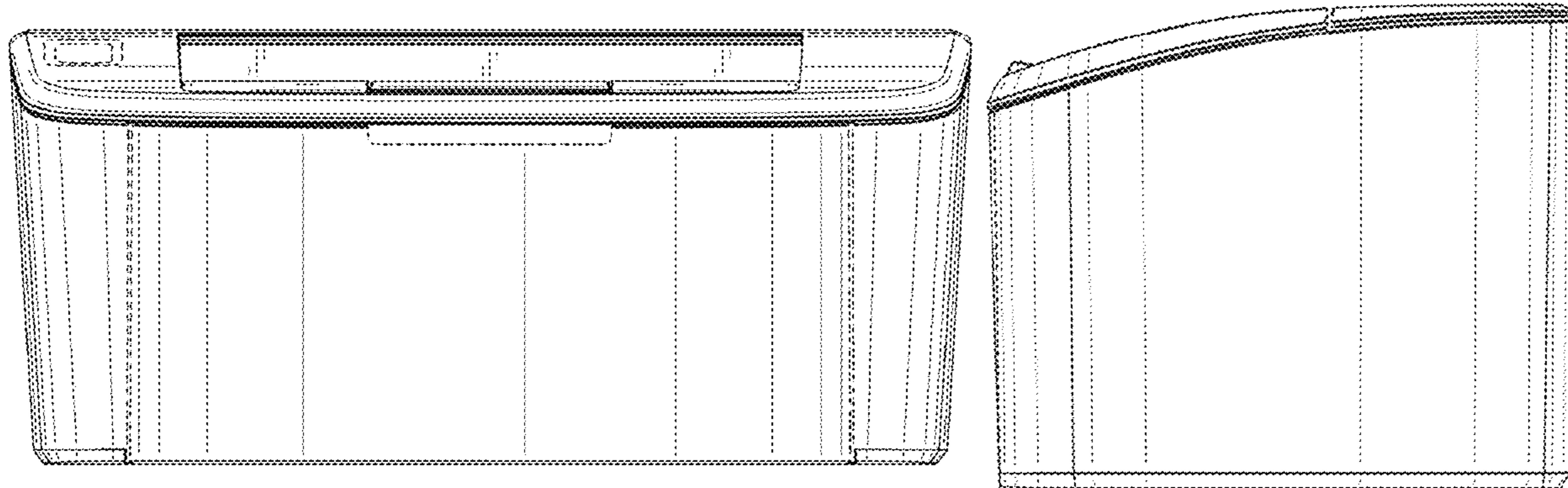

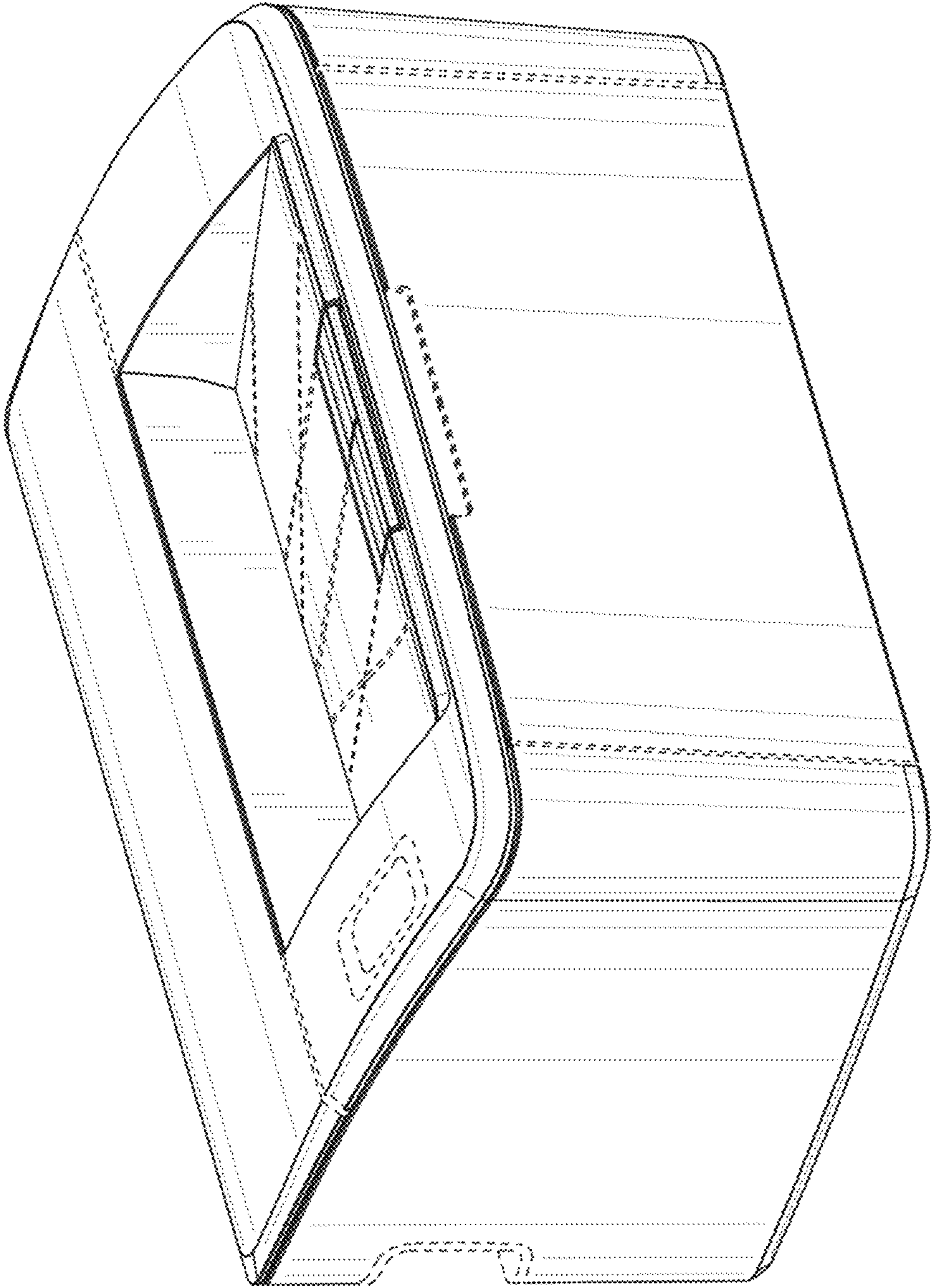

FIG. 1

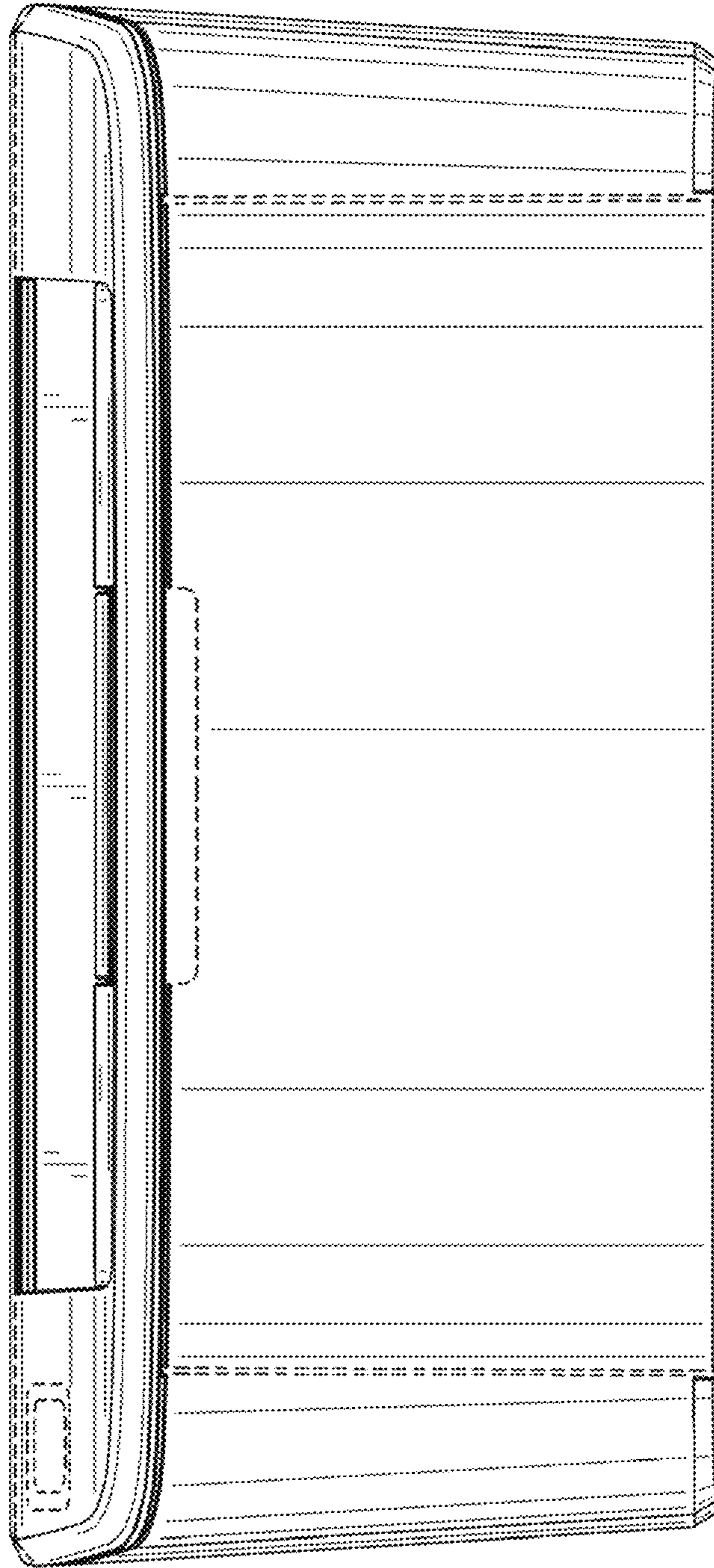

FIG. 2

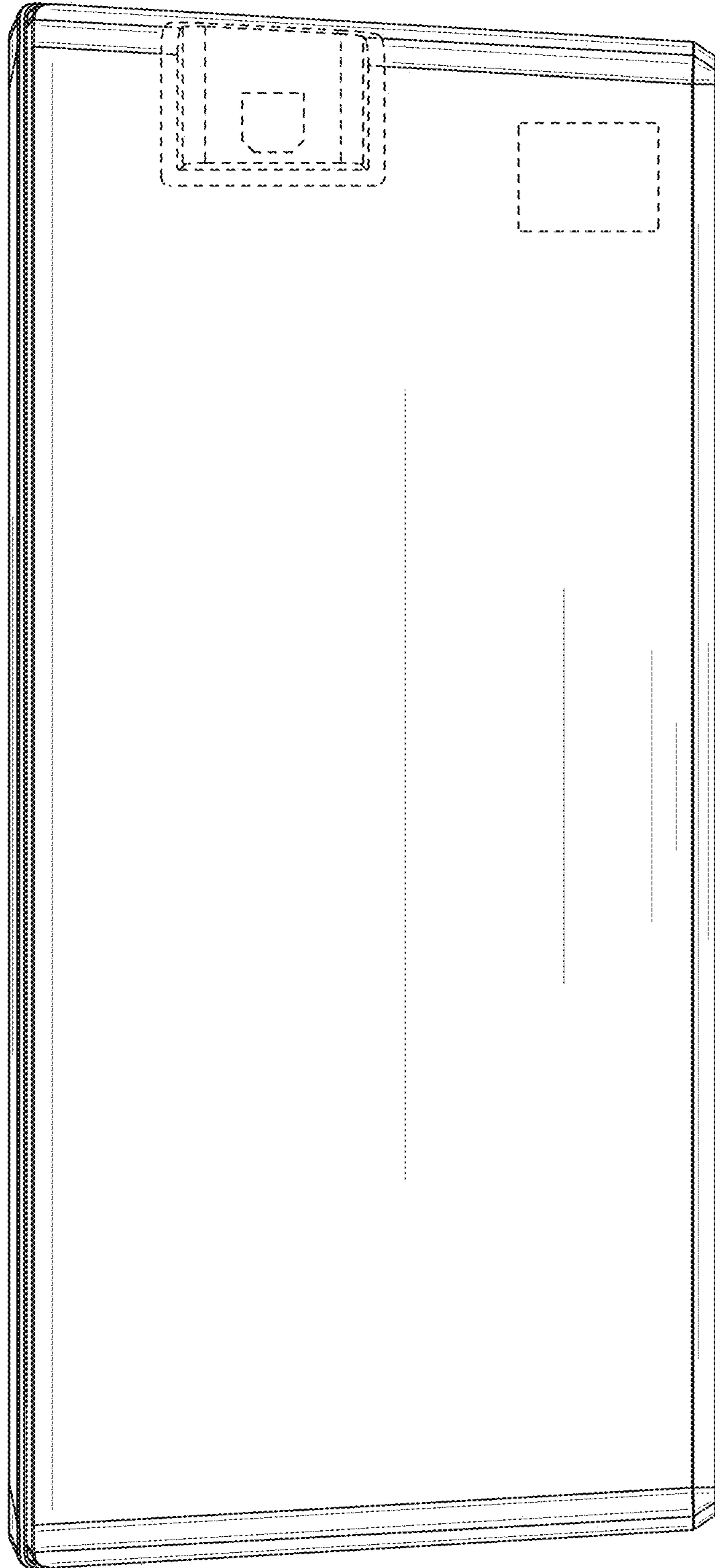

FIG. 3

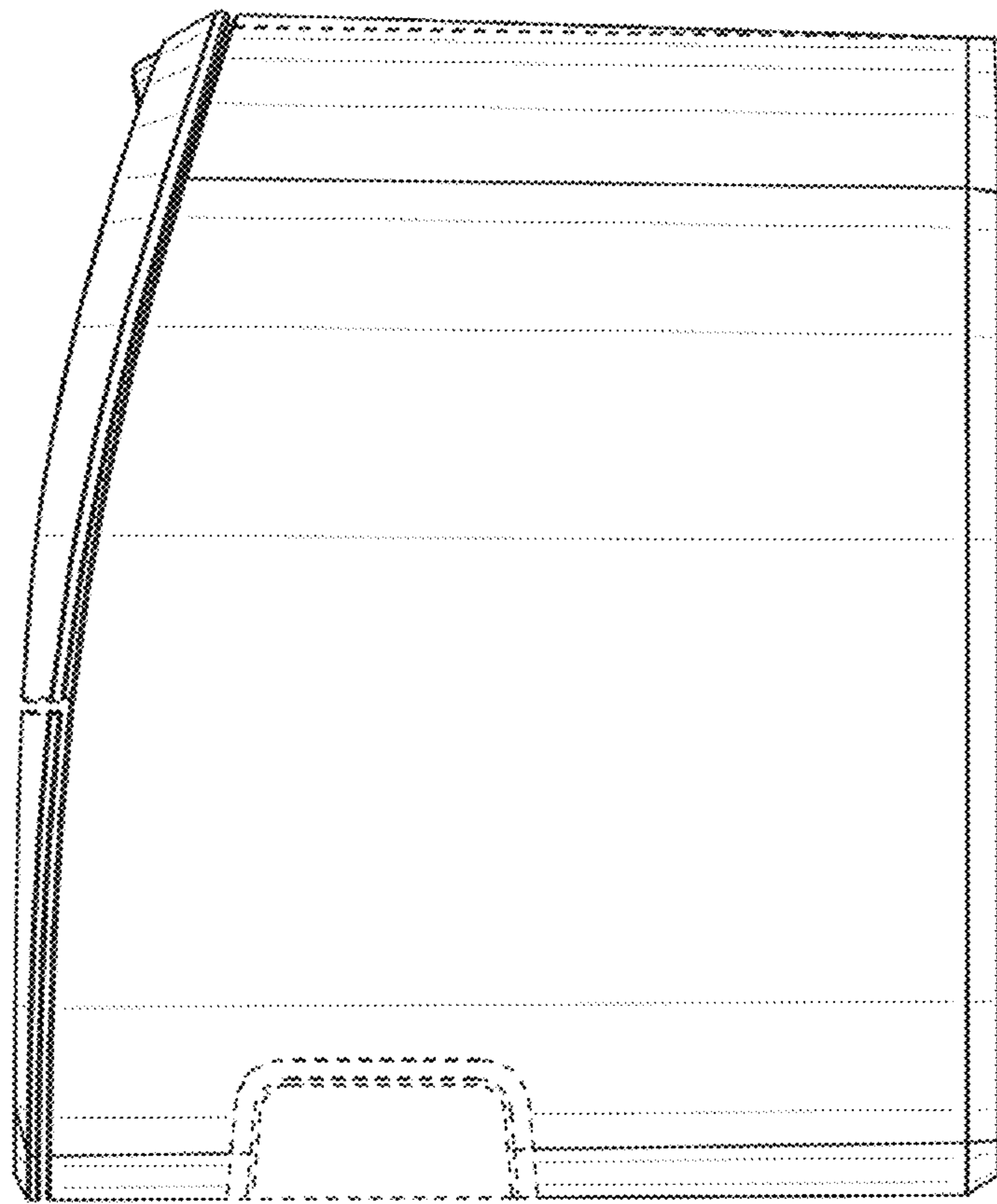

FIG. 4

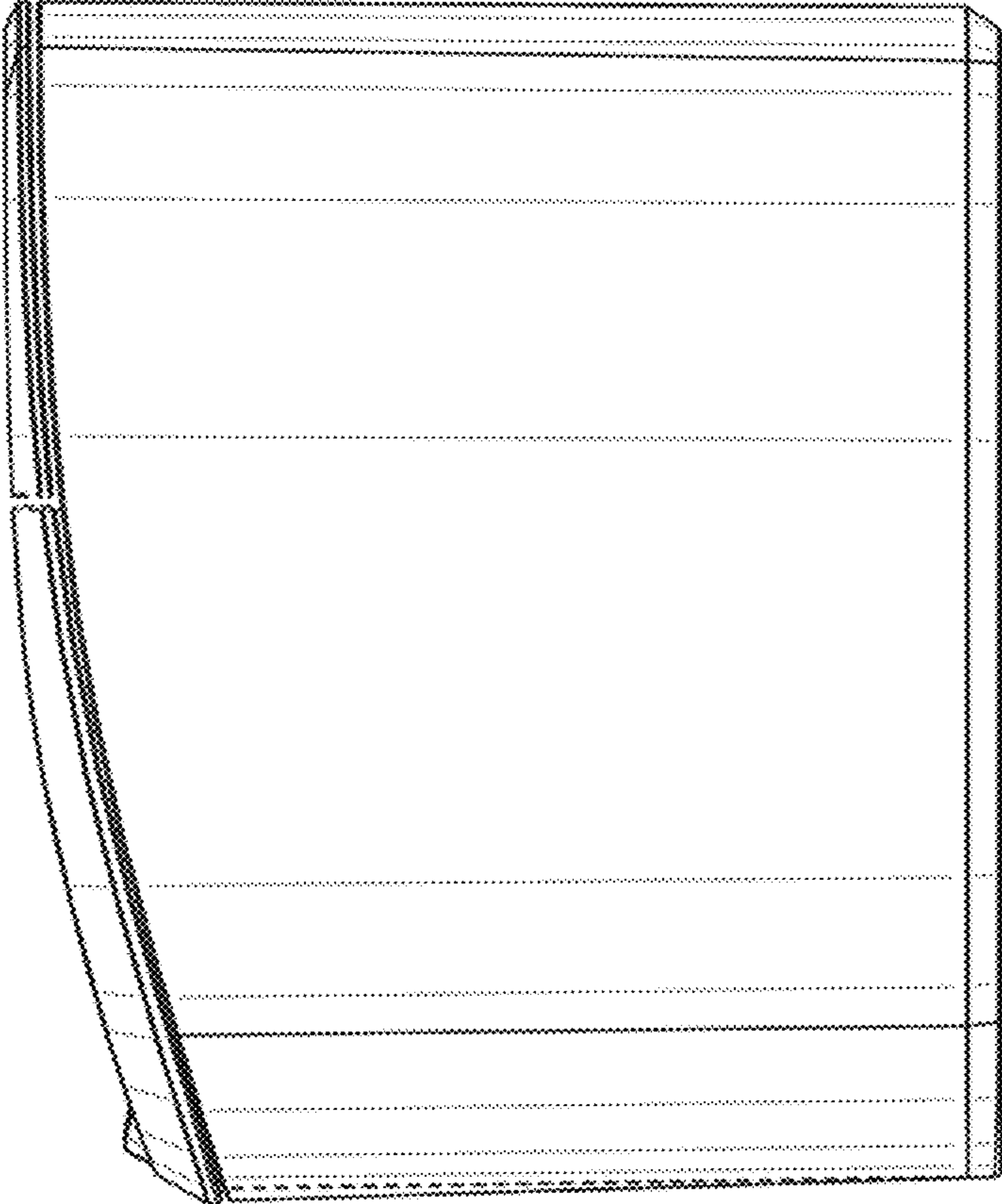

FIG. 5

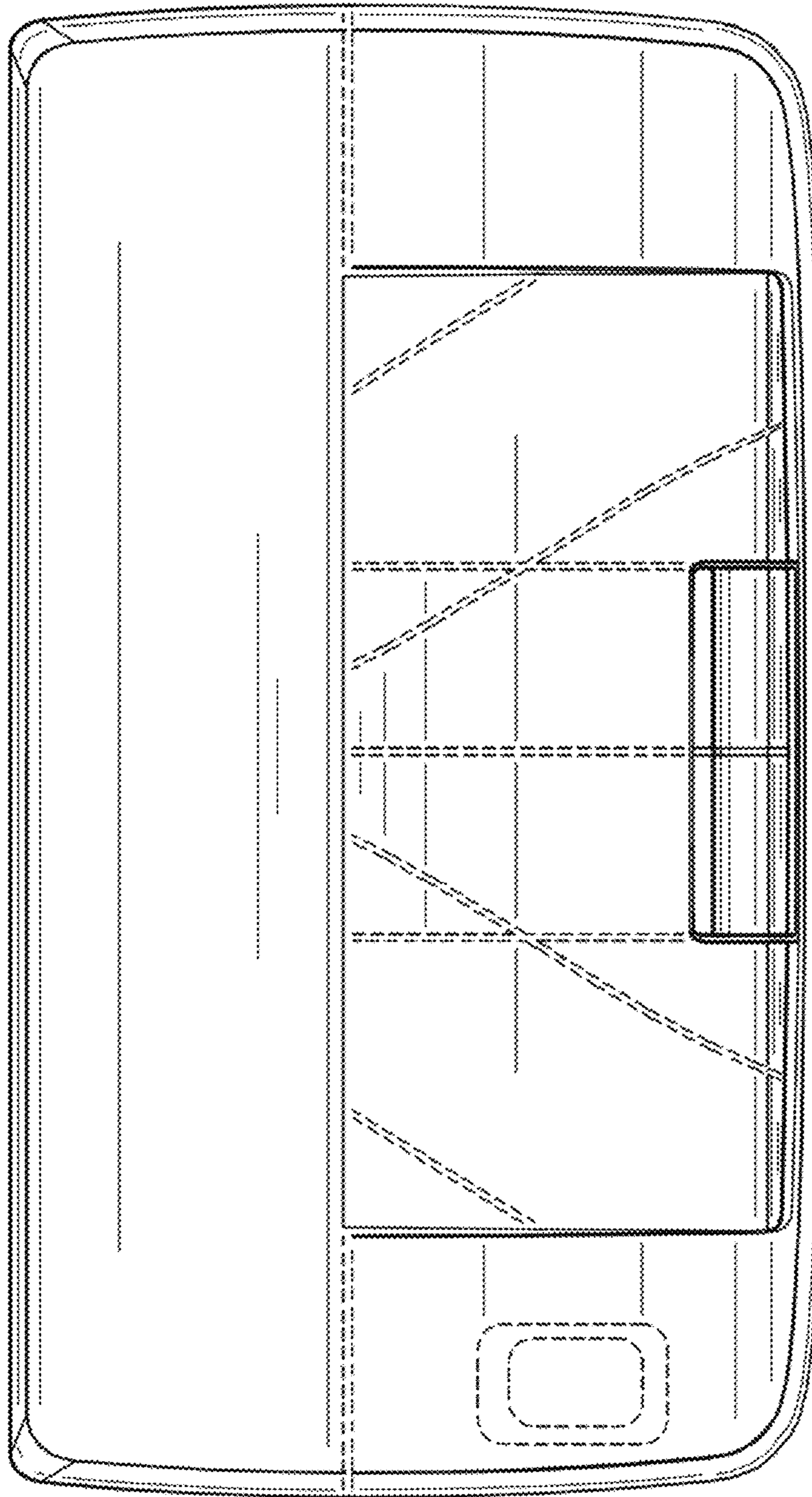

FIG. 6

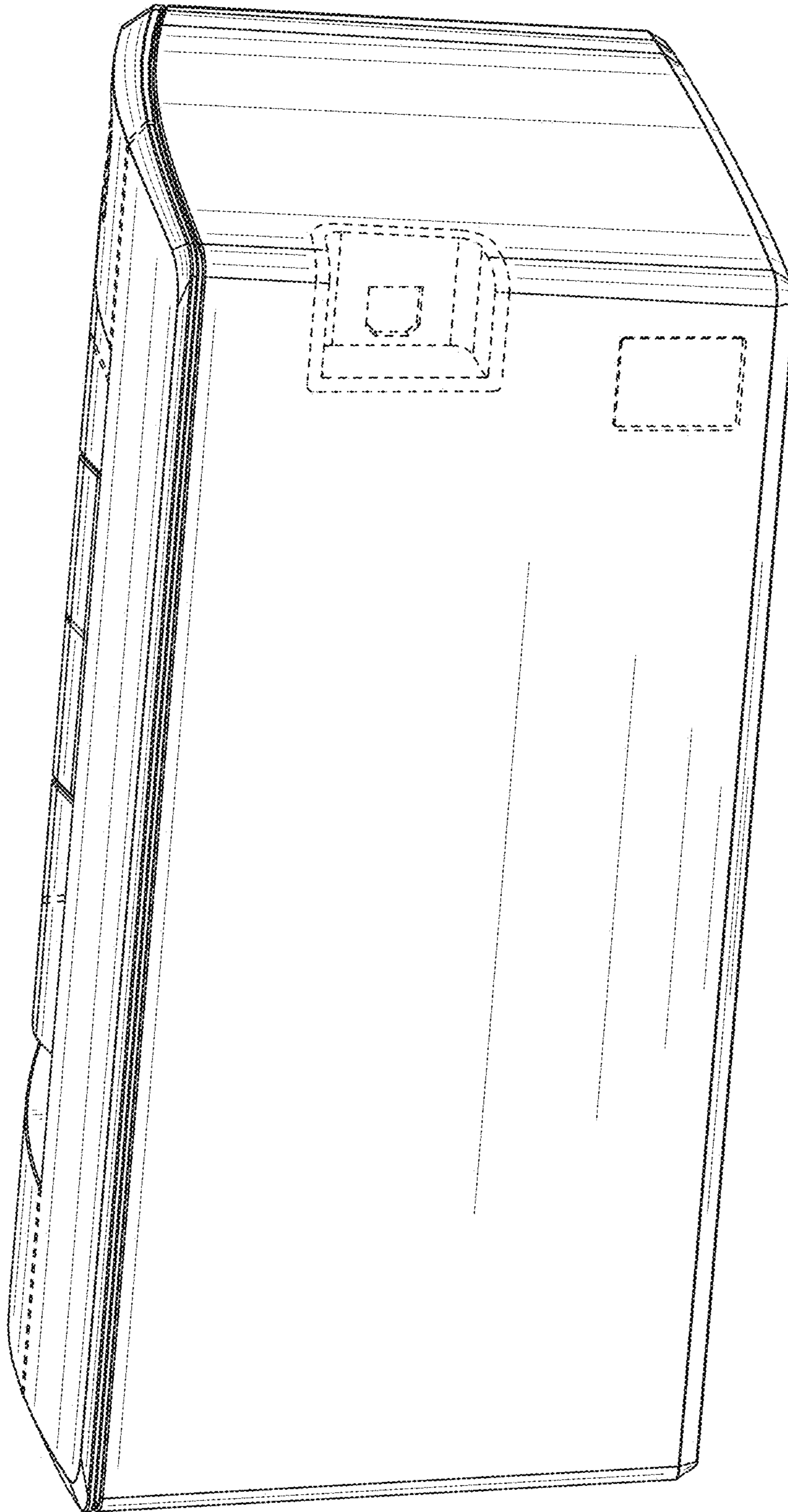

FIG. 8

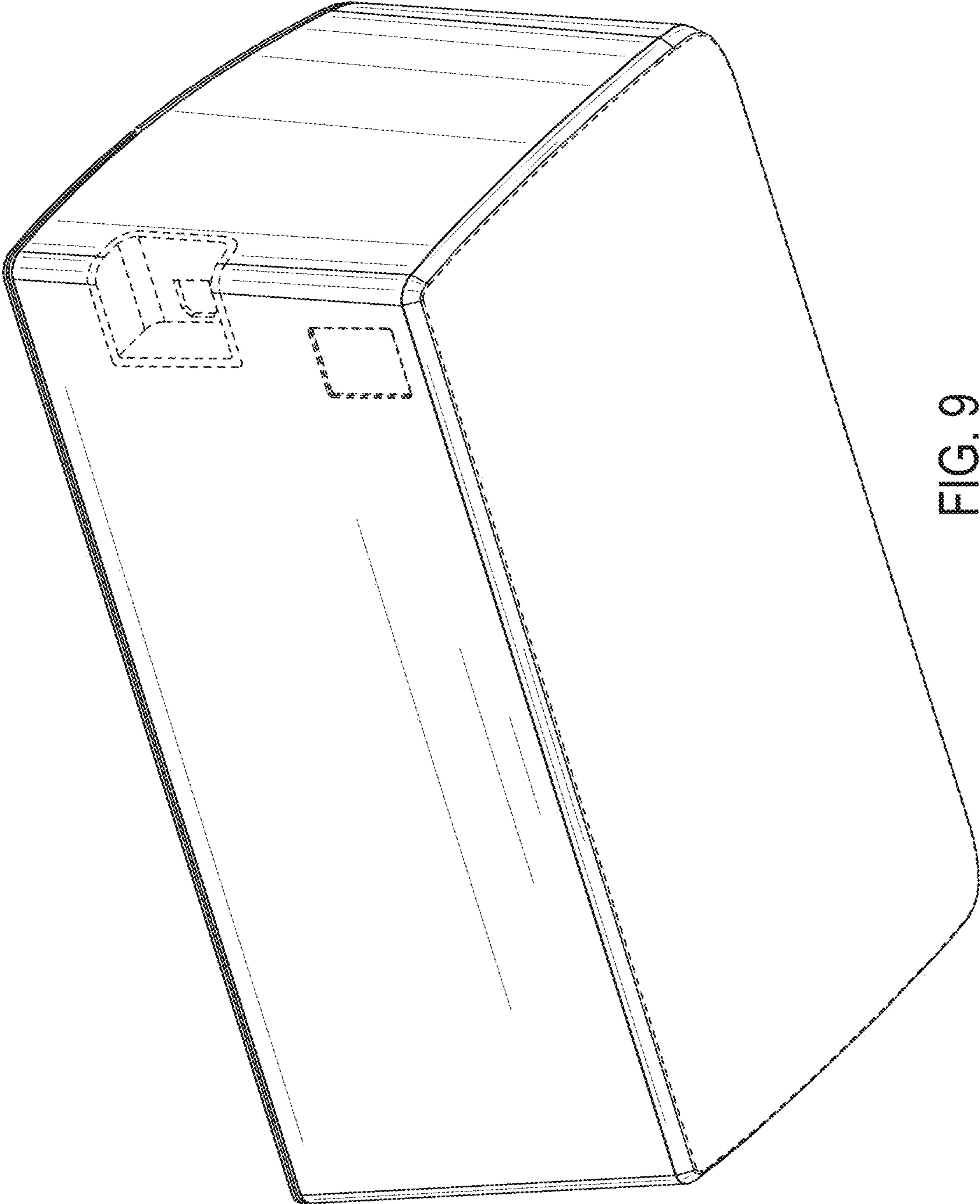

FIG. 9