



US00D893397S

(12) **United States Design Patent**
Ekstrom

(10) **Patent No.:** **US D893,397 S**

(45) **Date of Patent:** **** Aug. 18, 2020**

(54) **TRUCK RACK**

(71) Applicant: **Ekstrom Design & Fabrication Corp.**,
Salt Lake City, UT (US)

(72) Inventor: **David Ekstrom**, Salt Lake City, UT
(US)

(73) Assignee: **Ekstrom Design & Fabrication Corp.**,
Salt Lake City, UT (US)

(**) Term: **15 Years**

(21) Appl. No.: **29/694,241**

(22) Filed: **Jun. 9, 2019**

(51) **LOC (12) Cl.** **12-16**

(52) **U.S. Cl.**
USPC **D12/406**

(58) **Field of Classification Search**
USPC D12/401-414, 414.1; D3/304-306;
D6/552

CPC B60R 9/08; B60R 9/042; B60R 9/0423;
B60R 9/0426; B60R 9/045; B60R 9/048;
B60R 9/0485; B60R 9/05; B60R 9/052;
B60R 9/055; B60R 9/058; B60R 9/06;
B60R 9/065; B60R 9/10; B60R 9/12

See application file for complete search history.

(56) **References Cited**

U.S. PATENT DOCUMENTS

2,387,779	A *	10/1945	Strauss	B60R 9/045 224/314
5,699,944	A *	12/1997	Duran	B60R 9/04 224/309
D422,553	S *	4/2000	VonDuyke	D12/412
D434,718	S *	12/2000	Kreisler	D12/412
D470,451	S *	2/2003	Bushart	D12/412
D490,042	S *	5/2004	Bailey	D12/406
D496,323	S *	9/2004	Buseman	D12/412
D503,144	S *	3/2005	Rex	D12/413
D537,404	S *	2/2007	Bauer	D12/412

(Continued)

OTHER PUBLICATIONS

Jeep Roof Rack System (07-18 JK), RoughCountry.com, [online],
[site visited Jun. 3, 2020]. <URL: <https://www.roughcountry.com/jk-roof-rack-10605c.html>> (Year: 2020).*

(Continued)

Primary Examiner — T Chase Nelson

Assistant Examiner — Jonathan J. Han

(74) *Attorney, Agent, or Firm* — Preston P. Frischknecht;
Project CIP

(57) **CLAIM**

The ornamental design for a truck rack, as shown and described.

DESCRIPTION

FIG. 1 is a top perspective view of a truck rack showing my new design;
FIG. 2 is a bottom perspective view thereof;
FIG. 3 is a top view thereof;
FIG. 4 is a bottom view thereof;
FIG. 5 is a left side view thereof;
FIG. 6 is a right side view thereof;
FIG. 7 is a front view thereof;
FIG. 8 is a back view thereof; and,
FIG. 9 is an enlarged view of the area 9 encircled by broken lines in FIG. 1 thereof.

The broken lines in the drawings depict portions of the truck rack that form no part of the claimed design. The broken lines used to form a circle in FIGS. 1 and 9 are included to identify the area of enlargement and form no part of the claimed design. The claimed design for the truck rack is directed to the portions shown in solid lines and shaded surfaces in FIGS. 1-9, and any portions not shown between the break lines near the center in FIGS. 1-6 form no part of the claimed design.

1 Claim, 7 Drawing Sheets

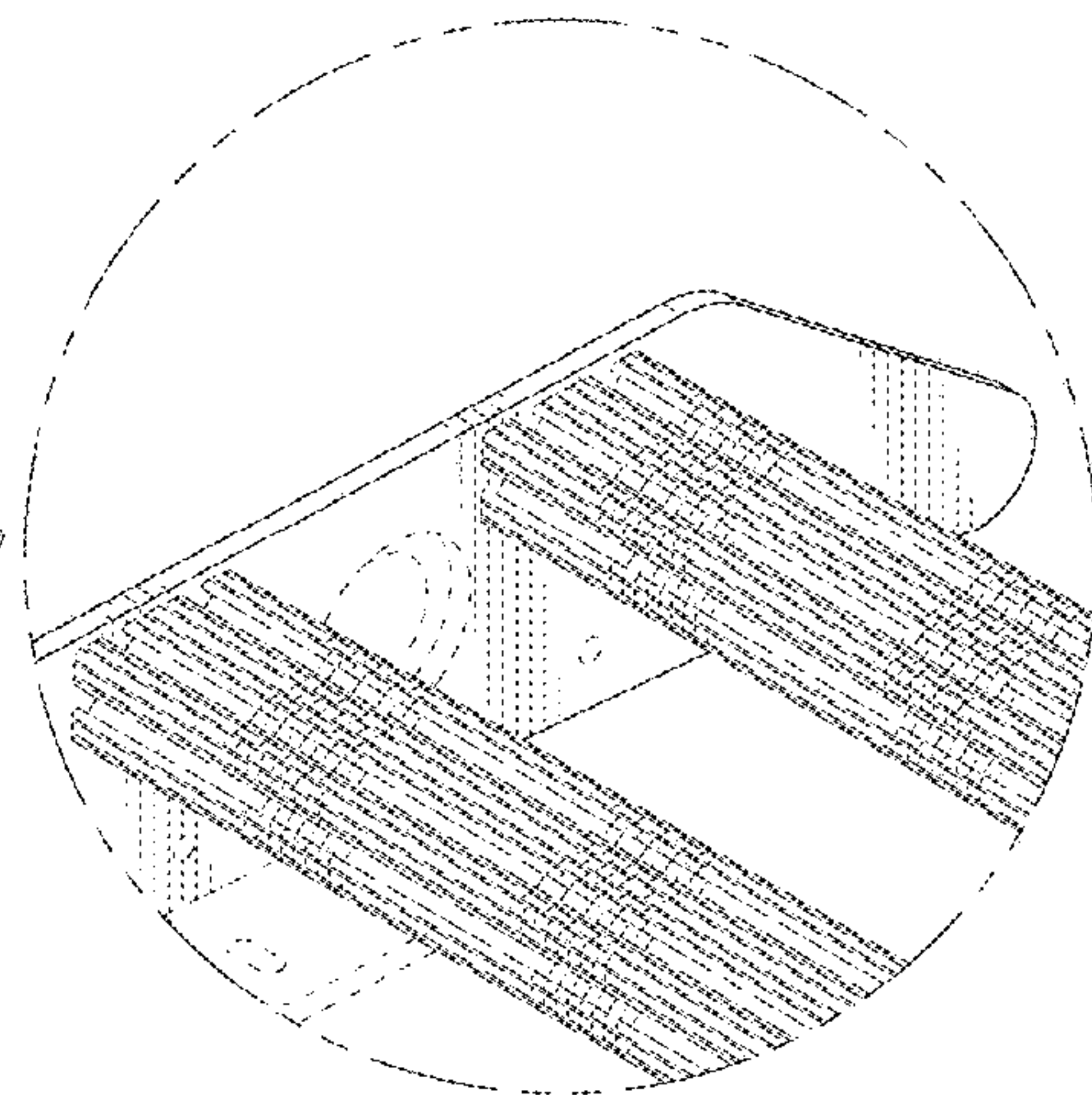
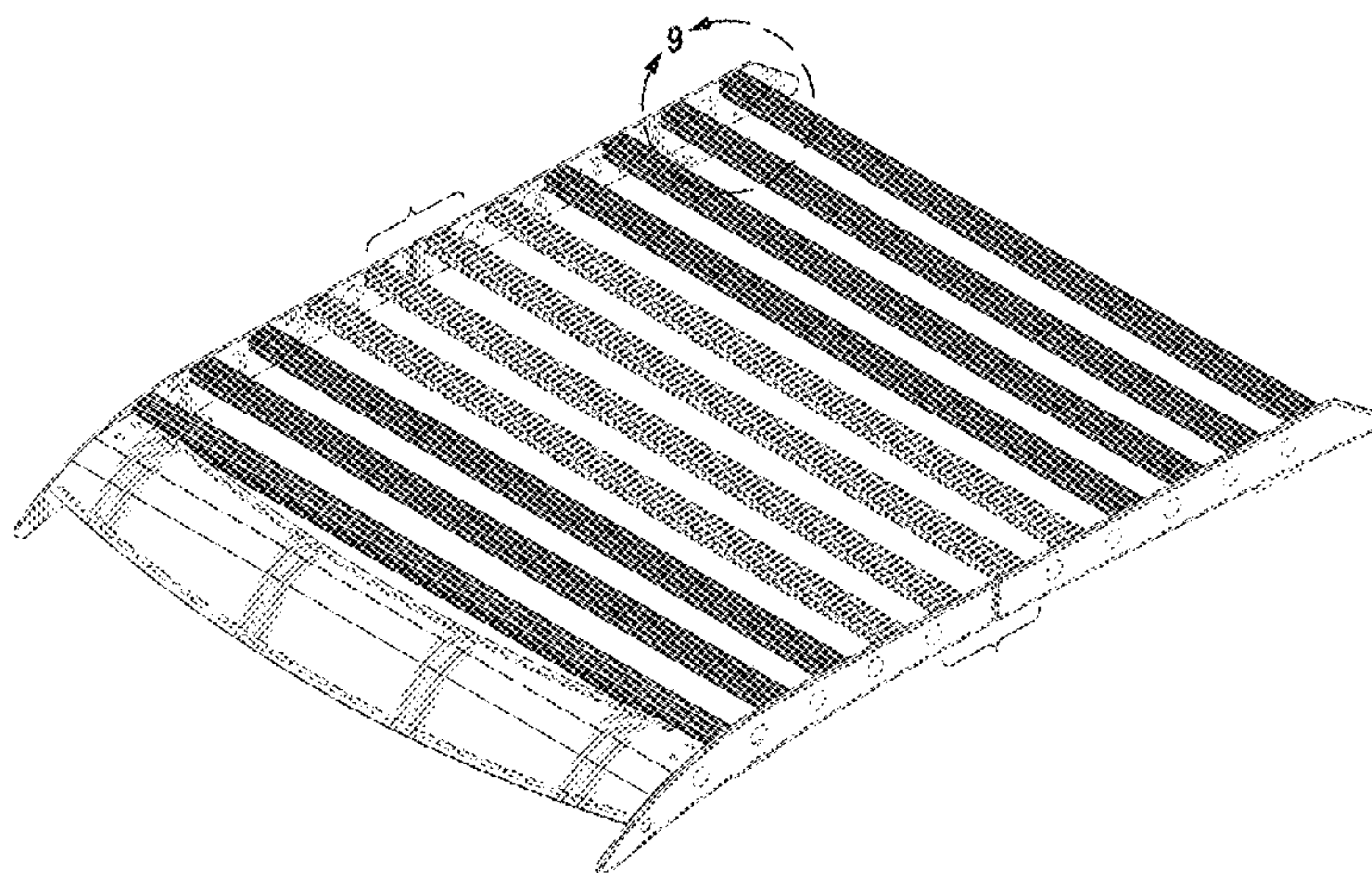

(56)

References Cited

U.S. PATENT DOCUMENTS

D558,123 S * 12/2007 Murillo D12/412
 D755,686 S * 5/2016 Clark D12/406
 D772,783 S * 11/2016 Schleef D12/412
 9,713,987 B2 * 7/2017 Arvidsson B60R 9/05
 D813,785 S * 3/2018 Badillo D12/412
 D815,012 S * 4/2018 Badillo D12/412
 D815,581 S * 4/2018 Anderson D12/406
 D841,565 S * 2/2019 Badillo D12/412
 D841,566 S * 2/2019 Badillo D12/412
 D845,873 S * 4/2019 Stoneburner D12/407
 D856,262 S * 8/2019 Marankie D12/412
 D865,645 S * 11/2019 Wisiak D12/412
 D866,448 S * 11/2019 Ash D12/412
 D879,013 S * 3/2020 Connellan D12/412
 D883,182 S * 5/2020 Fannesbeck D12/412
 2004/0195866 A1 * 10/2004 Fin B60R 9/045
 296/210
 2005/0092796 A1 * 5/2005 Essig B60R 9/00
 224/321
 2005/0189787 A1 * 9/2005 Chernoff B62D 25/06
 296/187.01

2007/0075108 A1 * 4/2007 Stapleton B60R 9/045
 224/321
 2017/0120836 A1 * 5/2017 Calvin B60J 7/106
 2019/0375337 A1 * 12/2019 Gauci B60R 9/058

OTHER PUBLICATIONS

MPH Production Universal Roof Rack for Truck (Cargo Car Top Luggage Carrier Basket Traveling SUV Holder) (RB-001-JJ-G), Amazon.com, Date First Available: Jun. 29, 2017, [online], [site visited Jun. 3, 2020]. <URL: <https://www.amazon.com/MPH-Production-Universal-Traveling-RB-001-JJ-G/dp/B07D73N9QH/ref>> (Year: 2017).*

N-FAB T102MRF Textured Black Roof Rack; Aluminum Modular Roof Rack Toyota 4 Runner Fits all styles 4 Door 10-18, Amazon.com, Date First Available: Aug. 22, 2016, [online], [site visited Jun. 3, 2020]. <URL: <https://www.amazon.com/T102MRF-Textured-Aluminum-Modular-Toyota/dp/B01KU471NO/ref=pd>> (Year: 2016).*

Jsport Plateau Roof Rack, JSportUSA.com, [online], [site visited Jun. 3, 2020]. <URL: <https://jsportusa.com/product/jsport-ridgeline-plateau/>> (Year: 2020).*

* cited by examiner

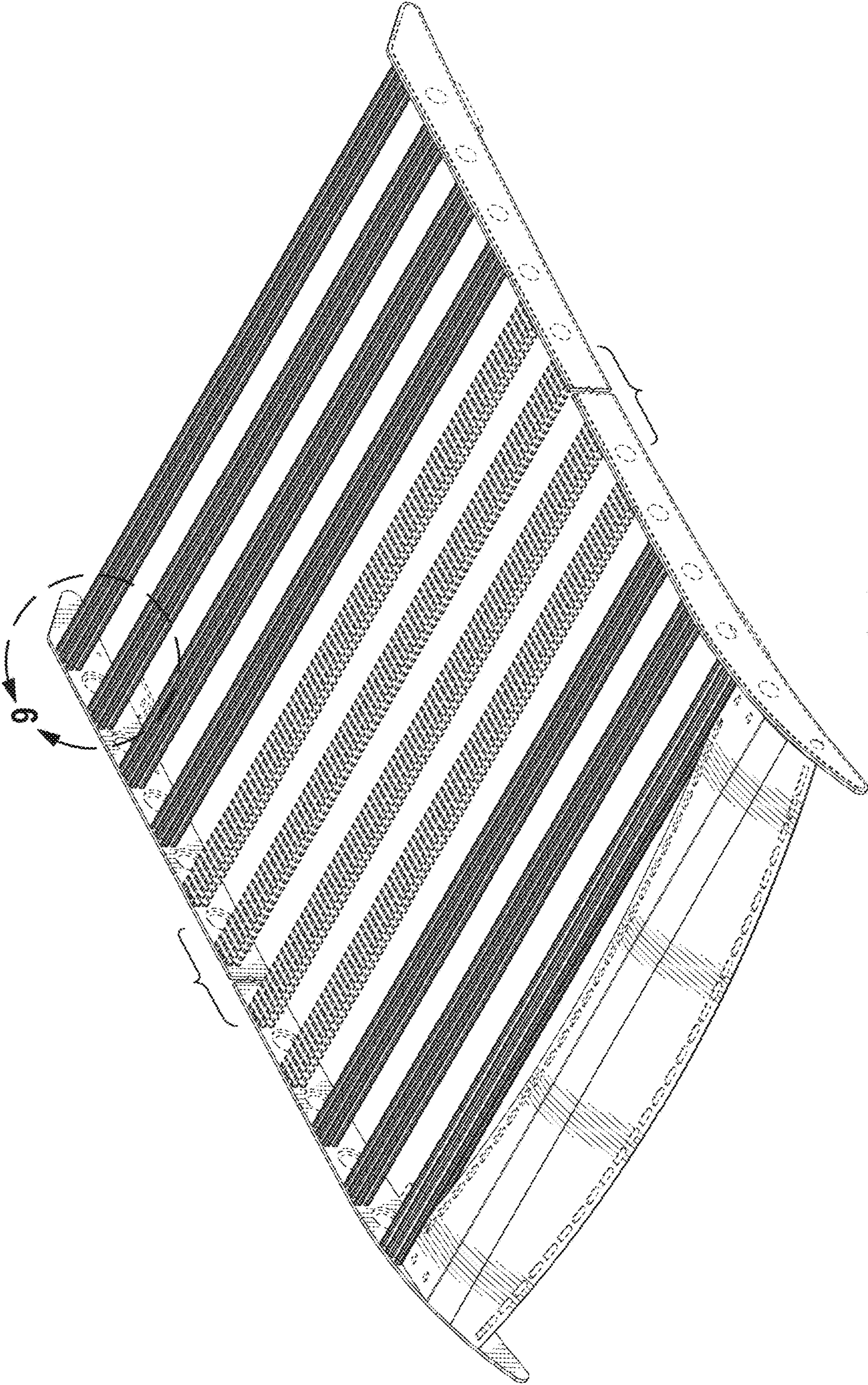

FIG. 1

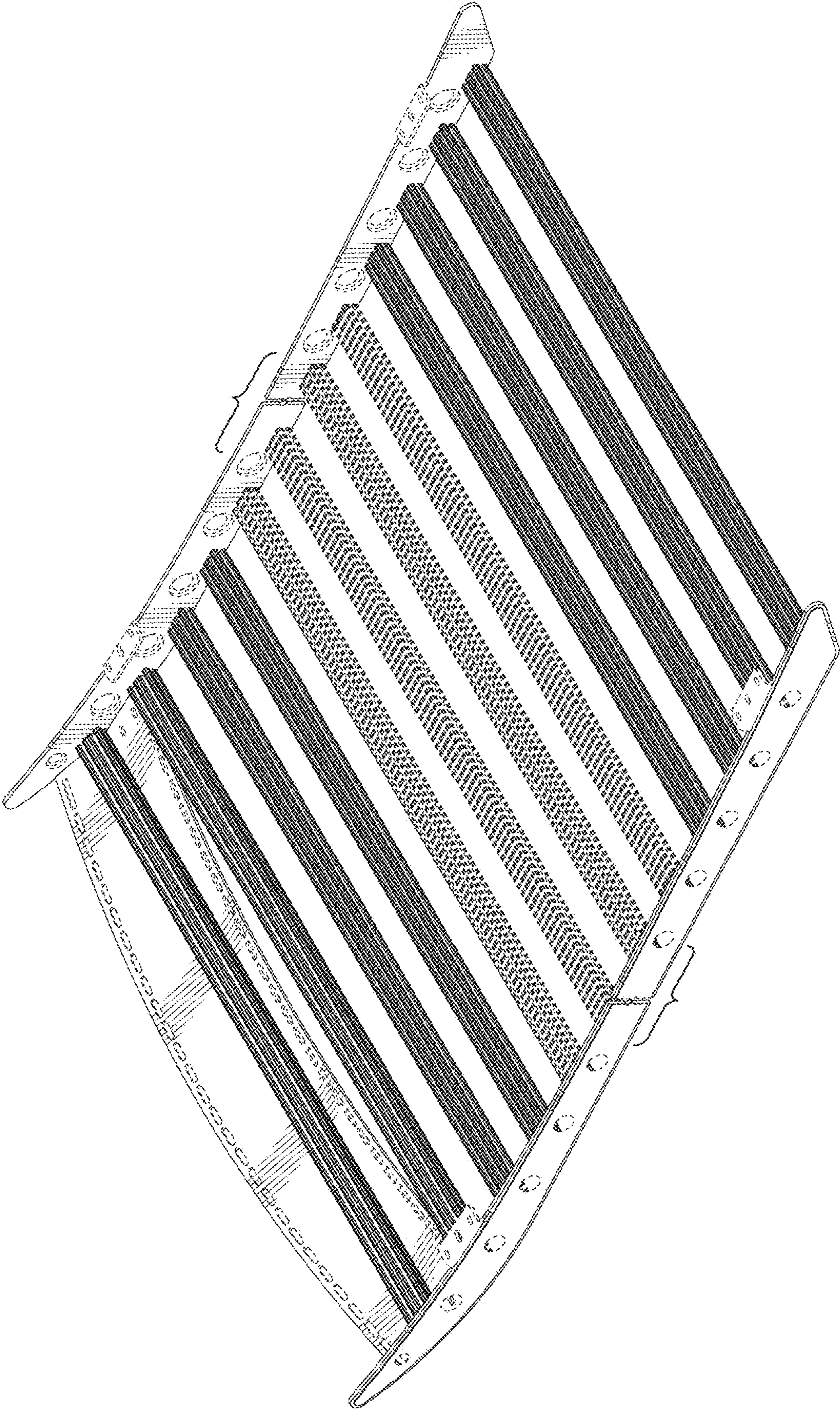

FIG. 2

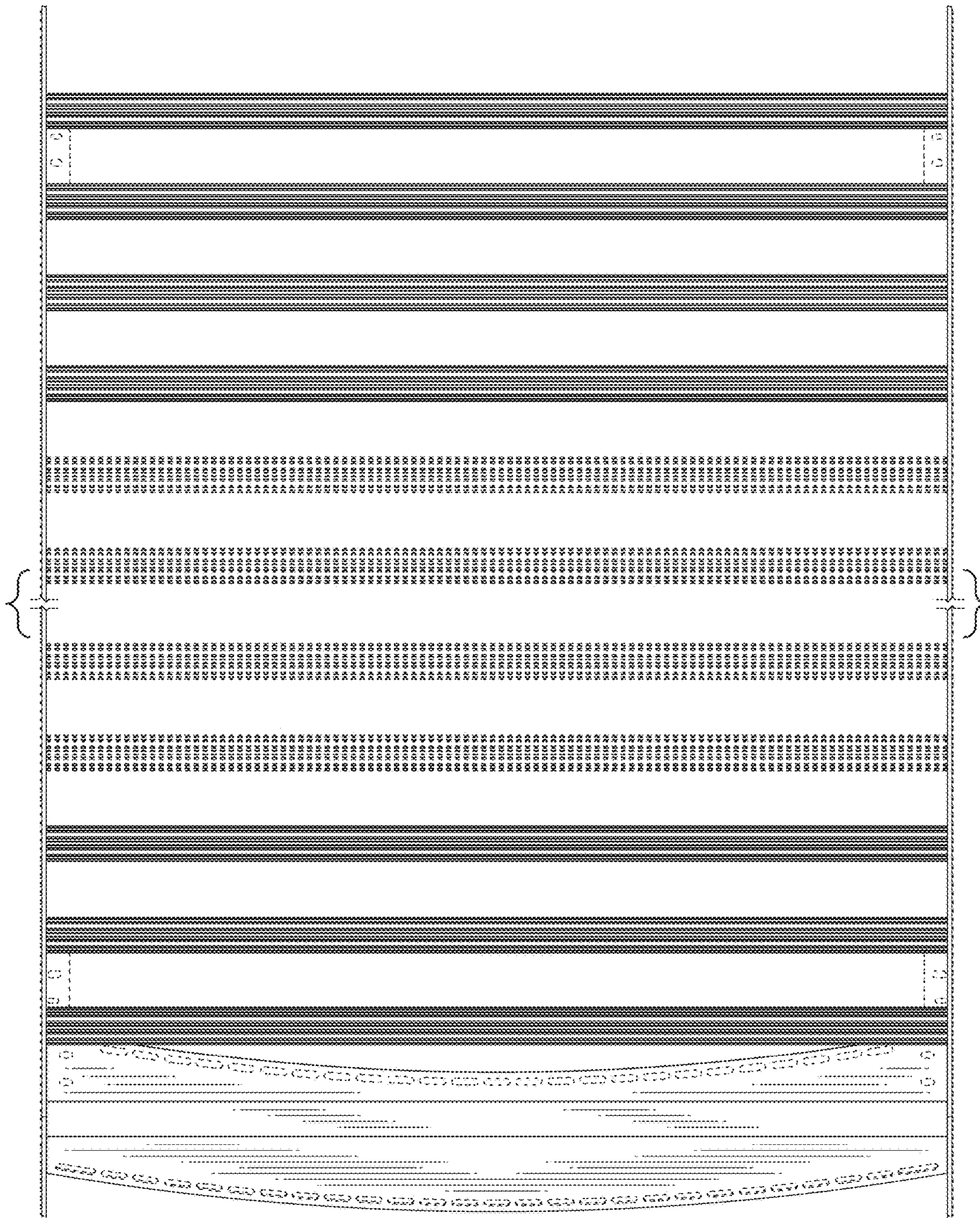

FIG. 3

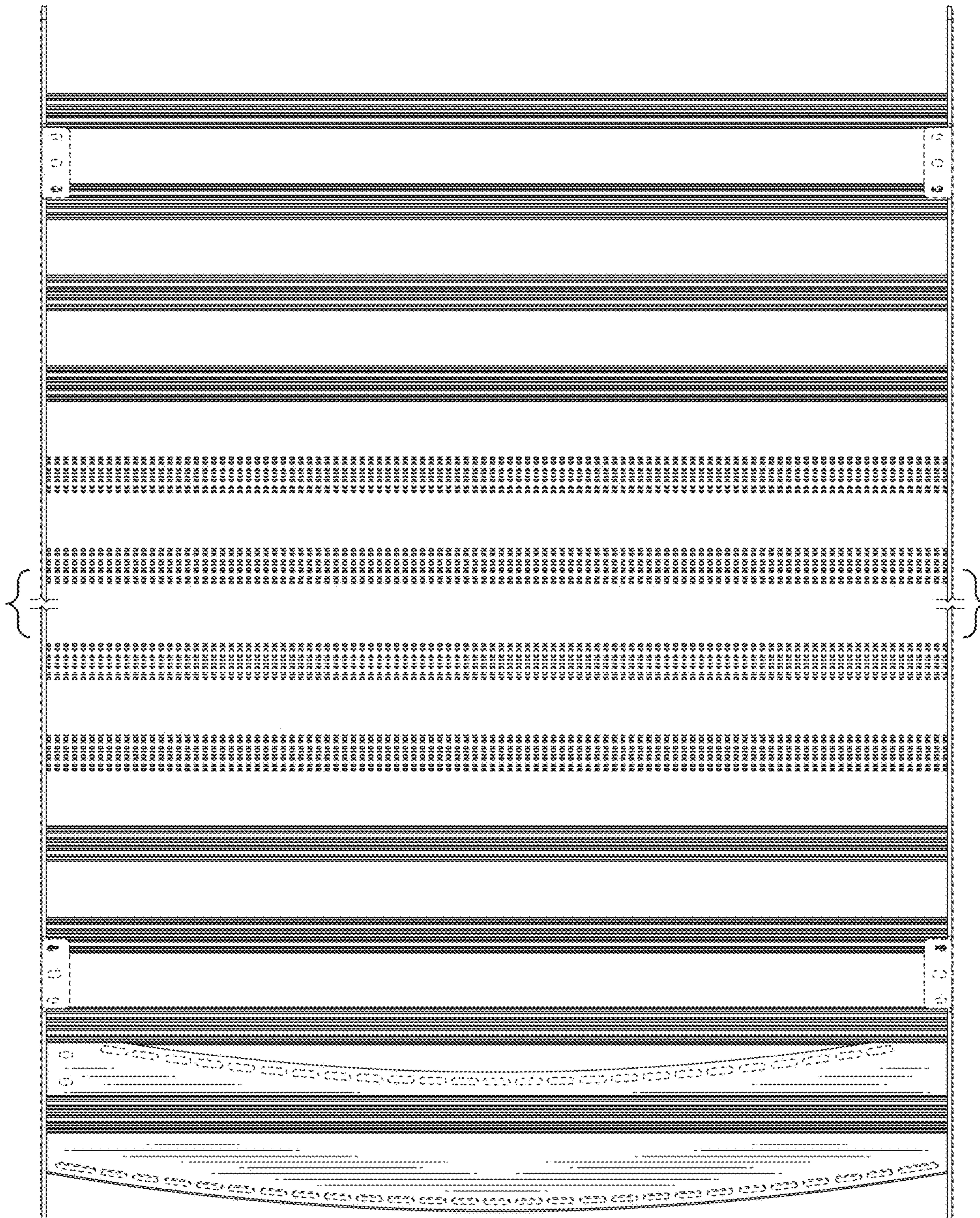

FIG. 4

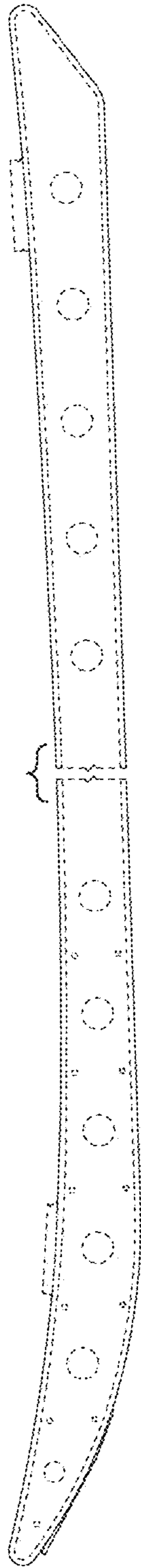

FIG. 5

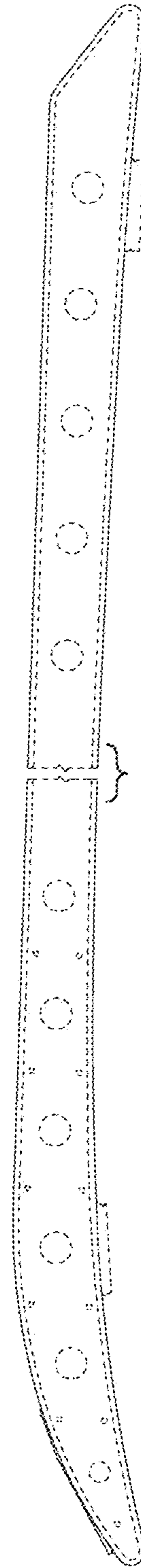

FIG. 6

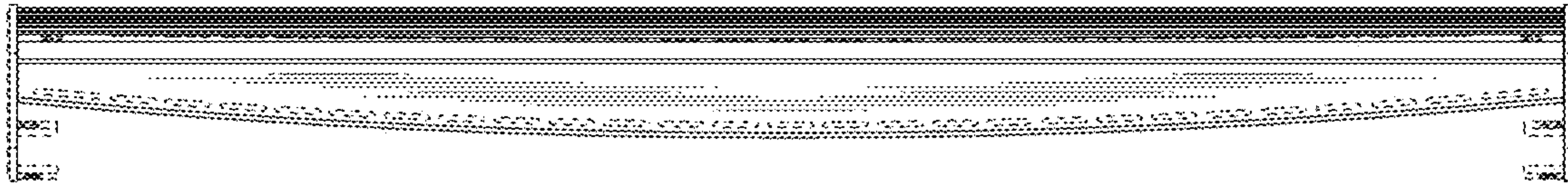

FIG. 7

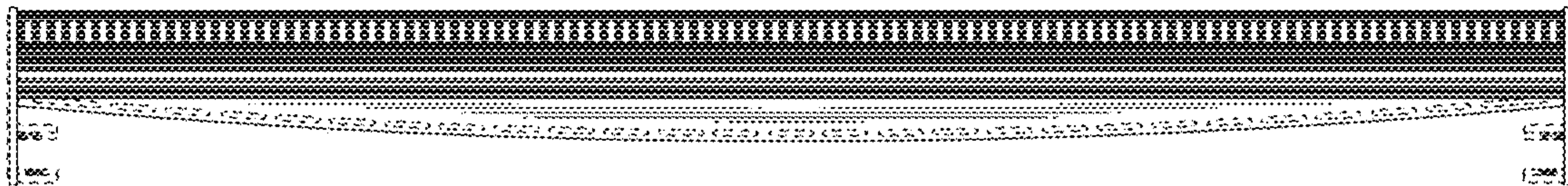

FIG. 8

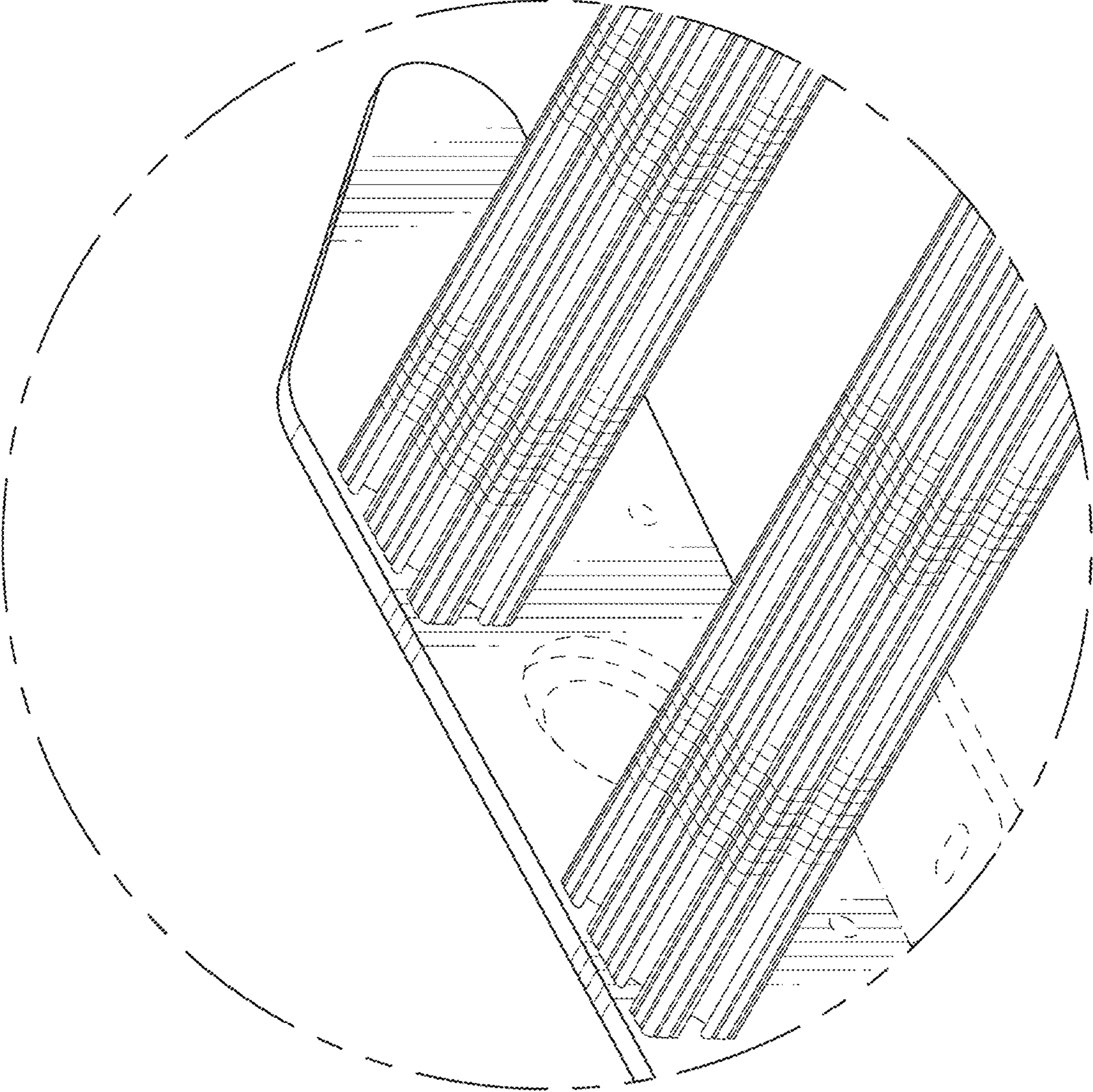

FIG. 9