

US00D893367S

(12) **United States Design Patent** (10) **Patent No.:** **US D893,367 S**
Kim et al. (45) **Date of Patent:** **** Aug. 18, 2020**

(54) **FRONT BUMPER FOR AN AUTOMOBILE**
(71) Applicants: **Kia Motors Corporation**, Seoul (KR);
Hyundai Motor Company, Seoul (KR)
(72) Inventors: **Ji Hun Kim**, Hwaseong-si (KR); **Yun Seok Oh**, Ansan-si (KR)
(73) Assignees: **Kia Motors Corporation**, Seoul (KR);
Hyundai Motor Company, Seoul (KR)
(**) Term: **15 Years**
(21) Appl. No.: **35/507,143**
(22) Filed: **Jan. 22, 2019**
(80) **Hague Agreement Data**
Int. Filing Date: **Jan. 22, 2019**
Int. Reg. No.: **DM/201439**
Int. Reg. Date: **Jan. 22, 2019**
Int. Reg. Pub. Date: **Aug. 2, 2019**

(30) **Foreign Application Priority Data**
Nov. 20, 2018 (KR) 30-2018-0053859
(51) **LOC (12) Cl.** **12-16**
(52) **U.S. Cl.**
USPC **D12/169**
(58) **Field of Classification Search**
USPC D12/86-92, 163-172
CPC B60R 19/18; B60R 19/24; B60R 19/44;
B60R 19/48; B60R 19/56; B60R
2019/527; B60R 2019/1886; B62D
25/0845
See application file for complete search history.

(56) **References Cited**
U.S. PATENT DOCUMENTS
D749,473 S * 2/2016 Lee D12/169
D763,146 S * 8/2016 Tsutamori D12/169

D763,746 S * 8/2016 Tsutamori D12/169
D775,010 S * 12/2016 Kim D12/169
9,688,227 B2 * 6/2017 Cepollaro B60R 19/50
D793,296 S * 8/2017 Smith D12/169
D807,256 S * 1/2018 Piscitelli D12/169
D817,235 S * 5/2018 Bucher D12/169
D839,152 S * 1/2019 Horie D12/169
D839,153 S * 1/2019 Wada D12/169
D840,298 S * 2/2019 Smith D12/169
D847,042 S * 4/2019 Pinazzo D12/169
D851,557 S * 6/2019 Thurber D12/169
D854,979 S * 7/2019 Krieg D12/169
D855,511 S * 8/2019 Smith D12/169
D856,209 S * 8/2019 Dewitt D12/169
D856,864 S * 8/2019 Kapitonov D12/169
D870,614 S * 12/2019 Ea D12/170
D871,282 S * 12/2019 Lee D12/169
D875,624 S * 2/2020 Tanghe D12/169
D877,002 S * 3/2020 Iazard D12/169
2009/0243340 A1 * 10/2009 Goldsberry B60R 19/50
296/191

* cited by examiner

Primary Examiner — Darlington Ly
(74) *Attorney, Agent, or Firm* — Mintz Levin Cohn Ferris
Glovsky and Popeo, P.C.; Peter F. Corless; Carolina E.
Säve

(57) **CLAIM**
The ornamental design for a front bumper for an automobile,
as shown and described.

DESCRIPTION
1. Front bumper for an automobile
1.1 is a top, front, and left side perspective view of an front
bumper for an automobile showing our new design;
1.2 is a front elevation view thereof;
1.3 is a rear elevation view thereof;
1.4 is a right side elevation view thereof;
1.5 is a left side elevation view thereof;
1.6 is a top plan view thereof; and
1.7 is a bottom plan view thereof.

1 Claim, 7 Drawing Sheets

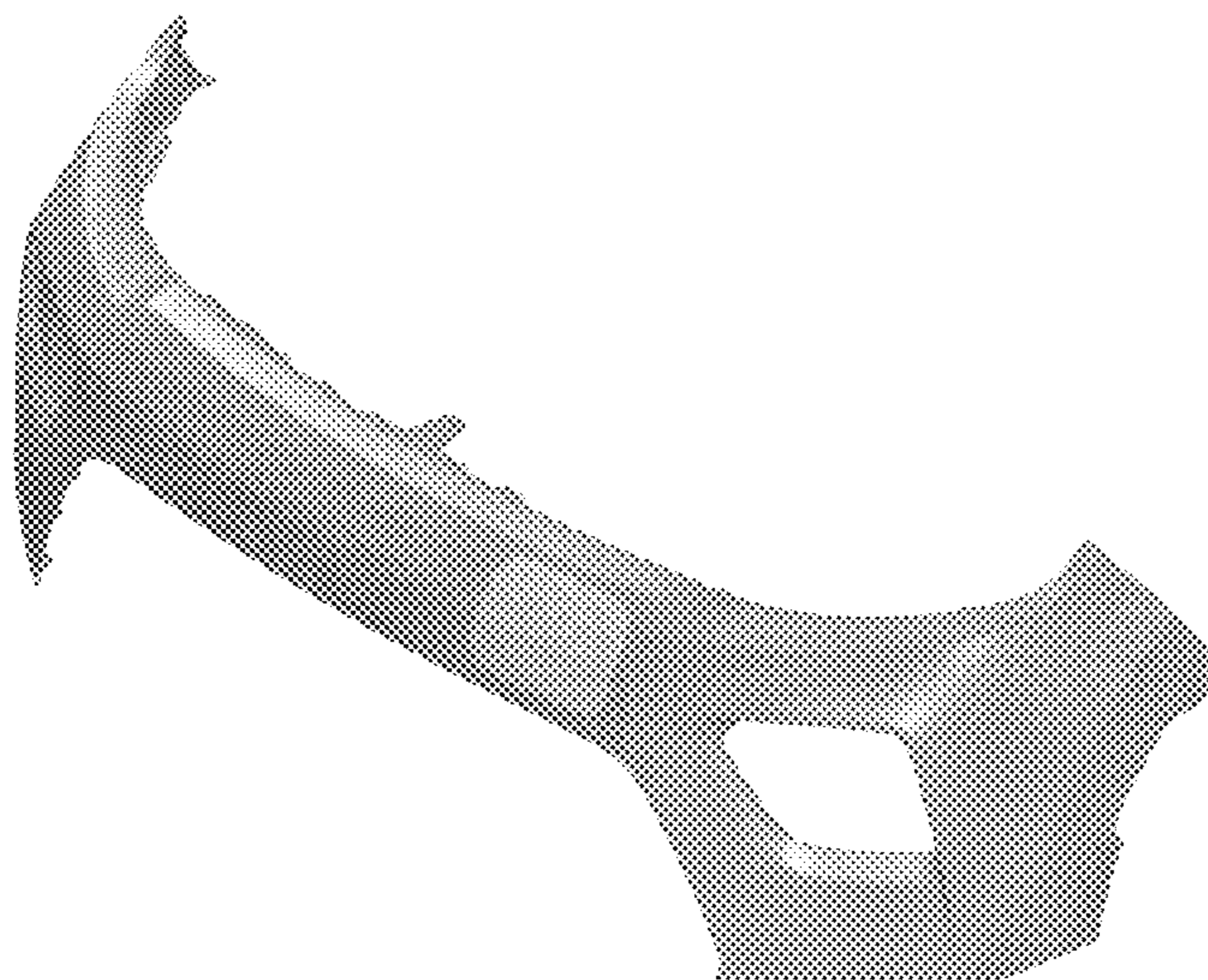

1.1

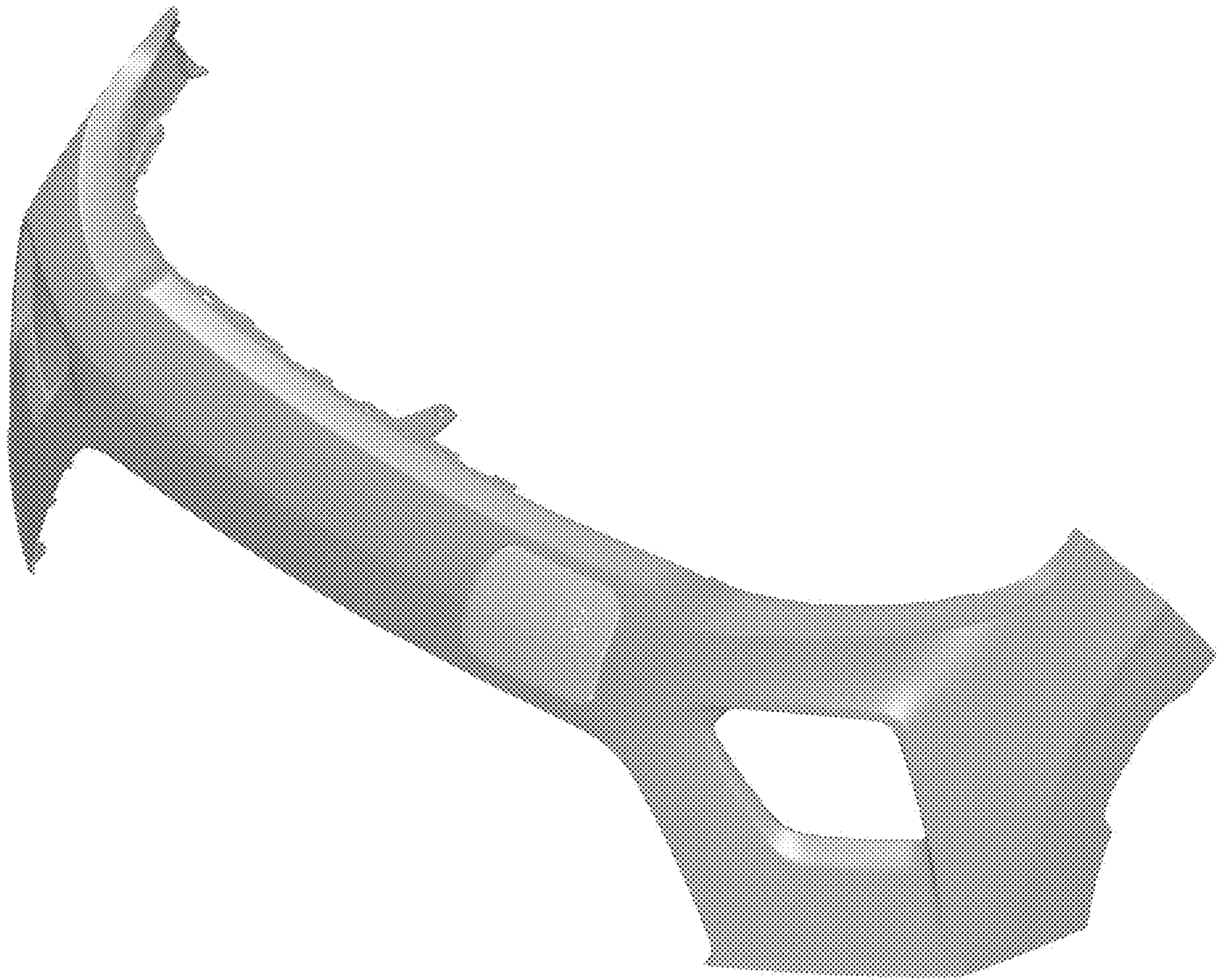

1.2

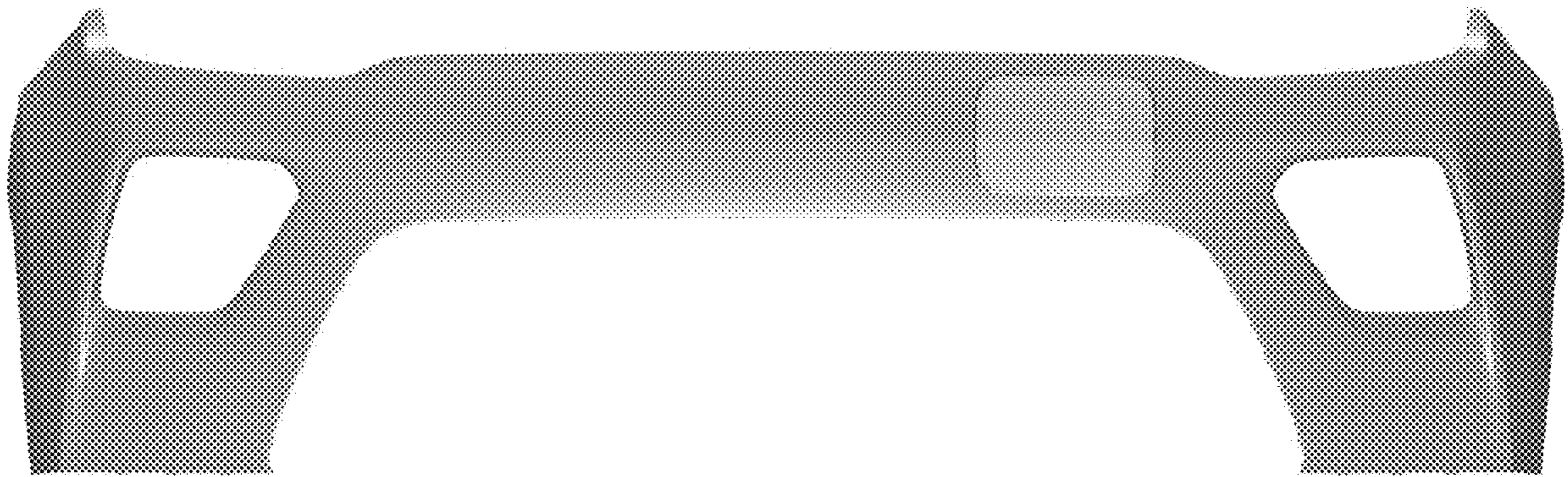

1.3

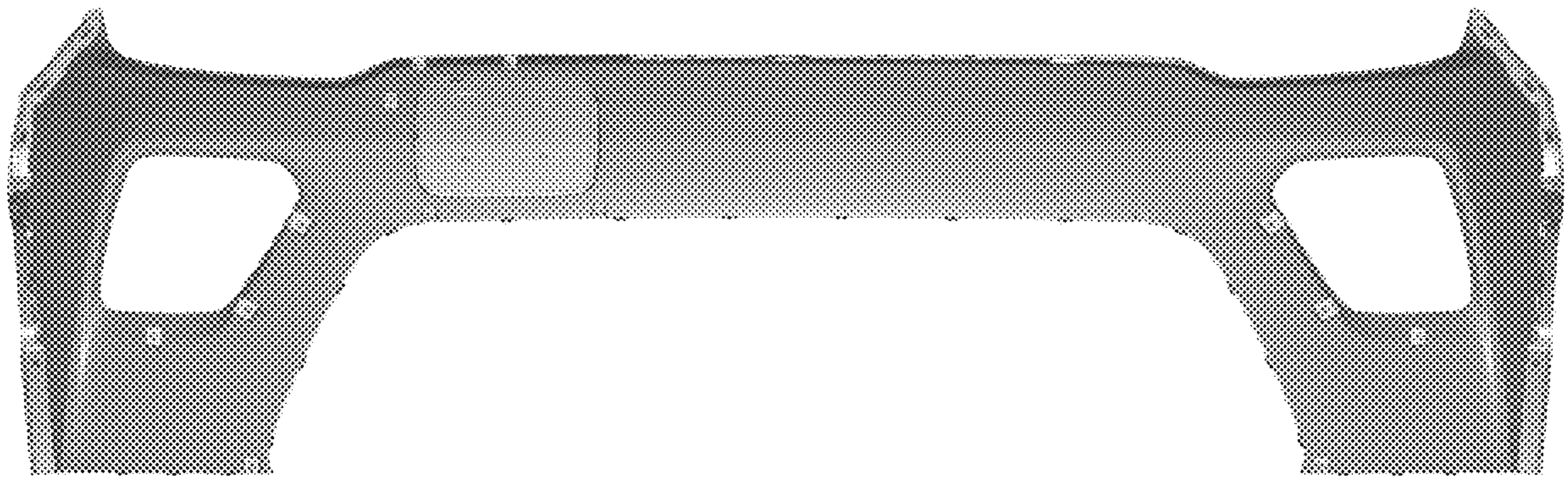

1.4

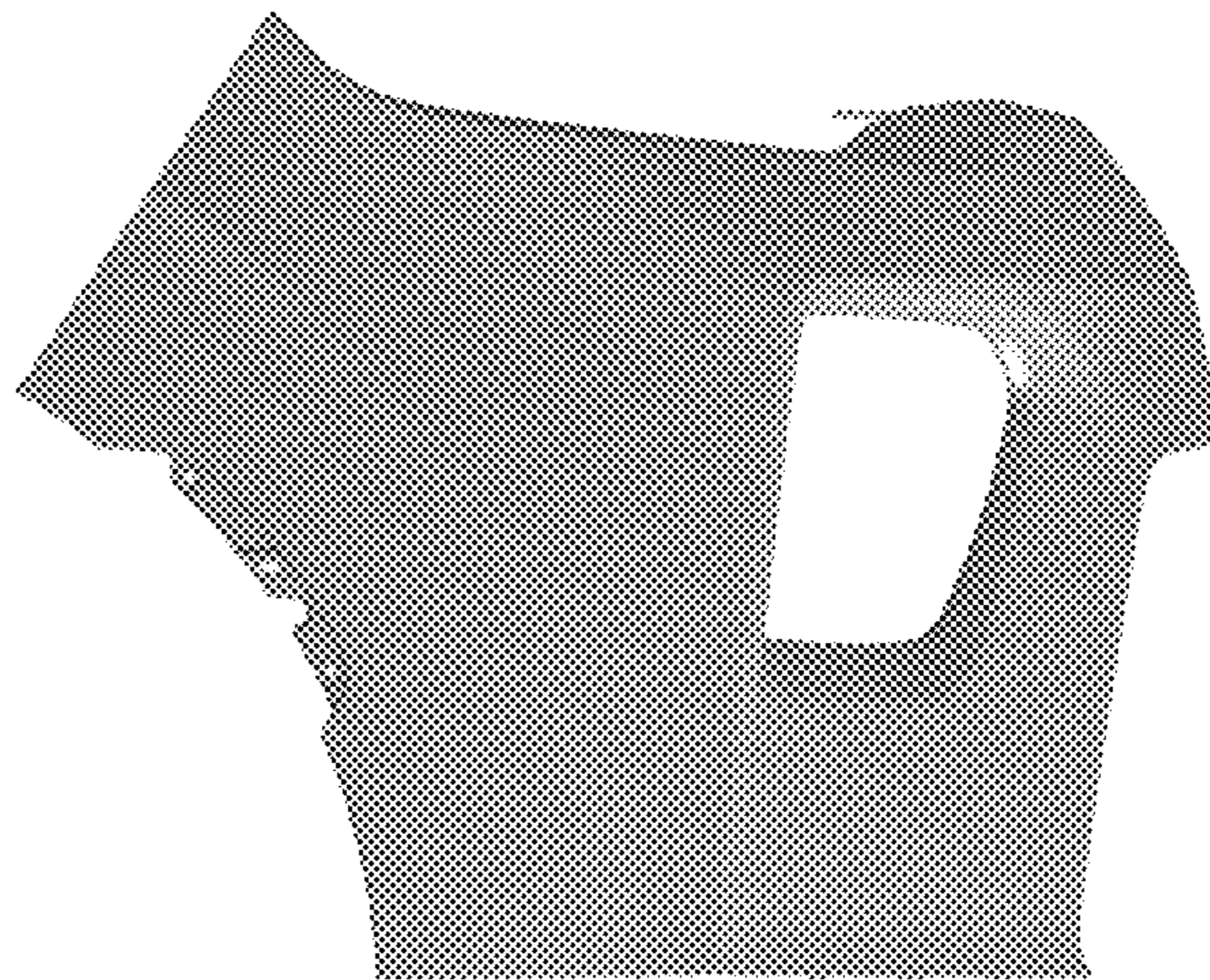

1.5

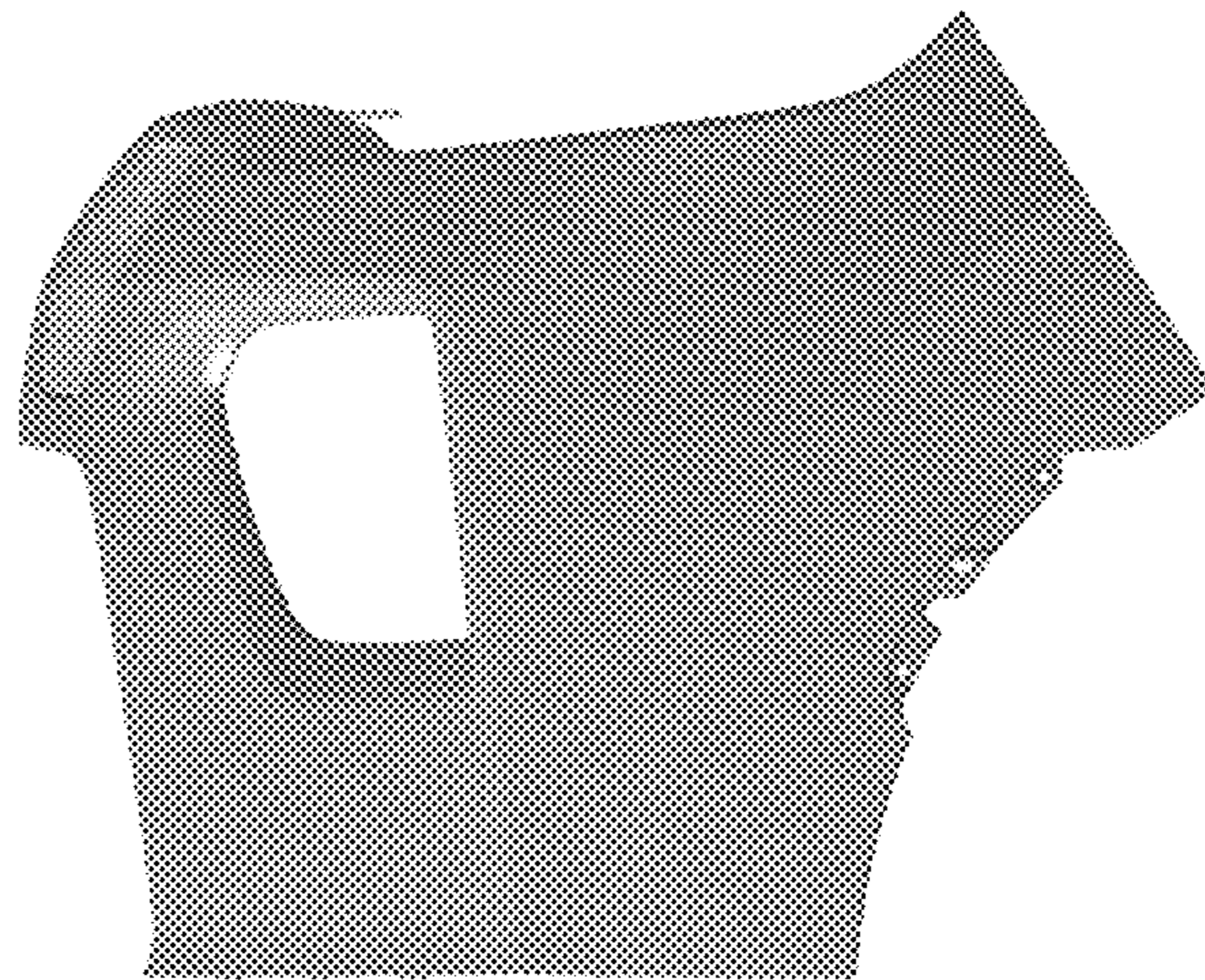

1.6

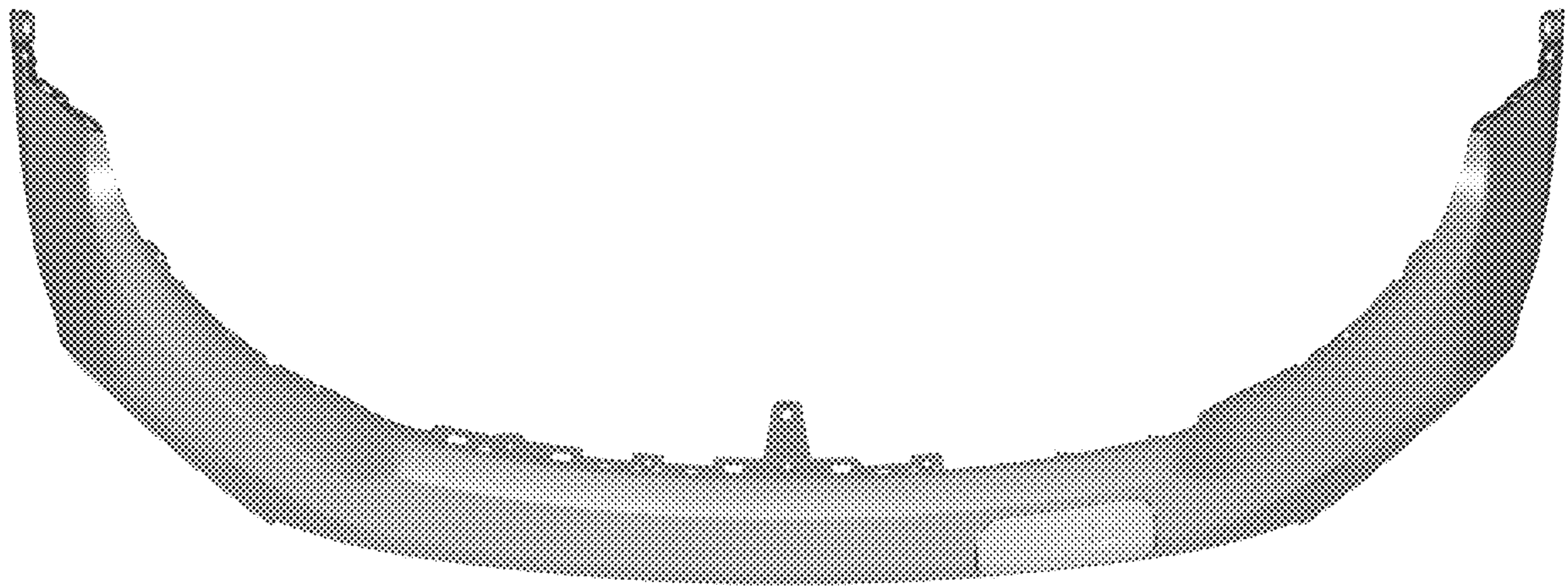

1.7

