



US00D893359S

(12) **United States Design Patent** (10) **Patent No.:** **US D893,359 S**
Holleis et al. (45) **Date of Patent:** **** *Aug. 18, 2020**

(54) **STROLLER FOR CHILDREN**

B62B 9/20; B62B 9/22; B62B 9/24;
B62B 9/26

(71) Applicant: **CYBEX GMBH**, Bayreuth (DE)

See application file for complete search history.

(72) Inventors: **Ralf Holleis**, Bayreuth (DE); **Johannes Häuser**, Bayreuth (DE)

(56) **References Cited**

(73) Assignee: **Cybex GmbH**, Bayreuth (DE)

U.S. PATENT DOCUMENTS

(*) Notice: This patent is subject to a terminal disclaimer.

D429,184	S	*	8/2000	Yang	D12/129
D434,704	S	*	12/2000	Huang	D12/129
D450,265	S	*	11/2001	Hsia	D12/129
D463,330	S	*	9/2002	Yang	D12/129
D463,332	S	*	9/2002	Wu	D12/129
D484,441	S	*	12/2003	Hsia	D12/129
D486,428	S	*	2/2004	Daykin	D12/129
D486,429	S	*	2/2004	Daykin	D12/129
D519,421	S	*	4/2006	Huang	D12/129
D608,254	S	*	1/2010	Grim	D12/129
D641,293	S	*	7/2011	Tsai	D12/129
D648,659	S	*	11/2011	Brevi	D12/129
D654,406	S	*	2/2012	Henry	D12/129
D677,604	S	*	3/2013	Ide	D12/129
D677,605	S	*	3/2013	Ide	D12/129
D726,078	S	*	4/2015	Liao	D12/129
D743,848	S	*	11/2015	Farmer	D12/129
D789,252	S	*	6/2017	Qiu	D12/129
D789,253	S	*	6/2017	Wang	D12/129
D802,489	S	*	11/2017	Stiba	D12/129
9,981,678	B1	*	5/2018	Chen	B62B 7/068
10,167,008	B1	*	1/2019	Yang	B62B 7/086
10,279,831	B2	*	5/2019	Huang	B62B 7/062

(**) Term: **15 Years**

(21) Appl. No.: **35/505,272**

(22) Filed: **Jan. 12, 2018**

(80) **Hague Agreement Data**

Int. Filing Date: **Jan. 12, 2018**

Int. Reg. No.: **DM/100833**

Int. Reg. Date: **Jan. 12, 2018**

Int. Reg. Pub. Date: **Jul. 13, 2018**

* cited by examiner

(30) **Foreign Application Priority Data**

Jul. 12, 2017 (WO) 4060301

Primary Examiner — Darlington Ly

(74) *Attorney, Agent, or Firm* — Boyle Fredrickson, S.C.

(51) **LOC (12) Cl.** **12-12**

(52) **U.S. Cl.**

USPC **D12/129**

(57) **CLAIM**

The ornamental design for a stroller for children, as shown and described.

(58) **Field of Classification Search**

USPC D12/128–130

CPC B62B 7/00; B62B 7/04; B62B 7/06; B62B

7/062; B62B 9/00; B62B 9/02; B62B

9/04; B62B 9/08; B62B 9/10; B62B 9/12;

B62B 9/14; B62B 9/16; B62B 9/18;

DESCRIPTION

1. Stroller for children

1.1 is a front, top, and right side perspective view of a stroller for children showing our new design;

1.2 is a front elevation view thereof;

1.3 is a rear elevation view thereof;

1.4 is a left side elevation view thereof;

(Continued)

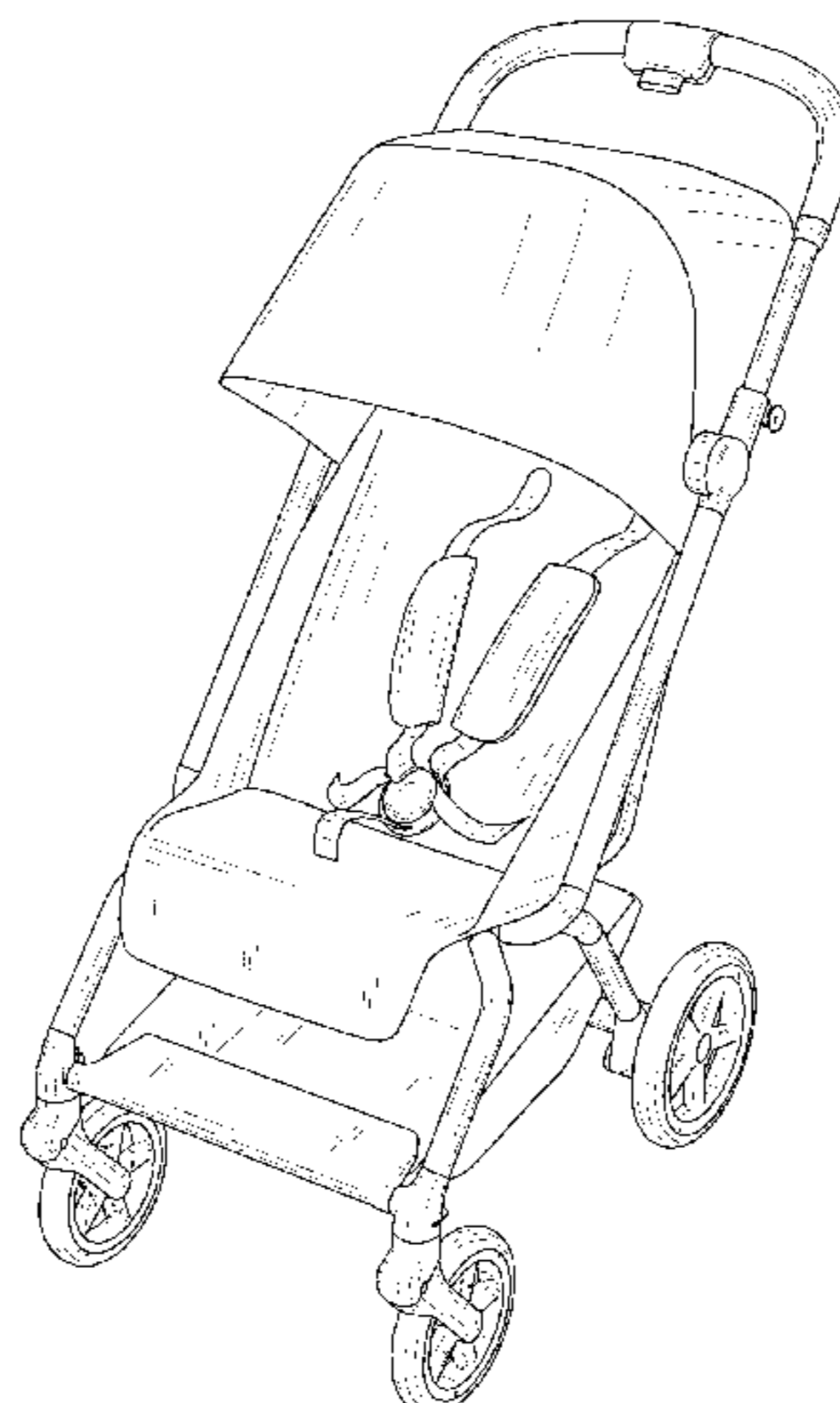

1.5 is a right side elevation view thereof;
1.6 is a top plan view thereof; and
1.7 is a bottom plan view thereof.

1 Claim, 7 Drawing Sheets

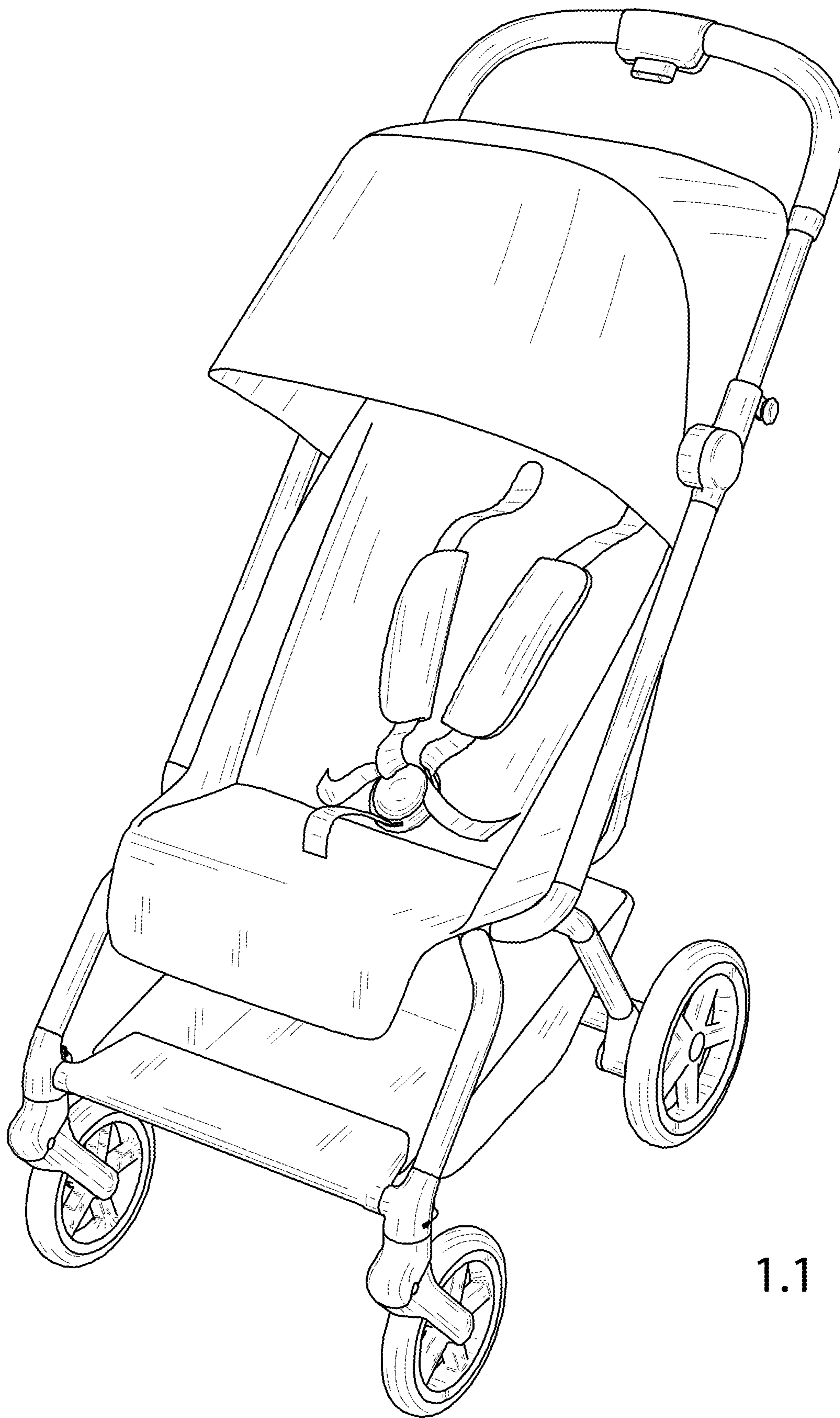

1.1

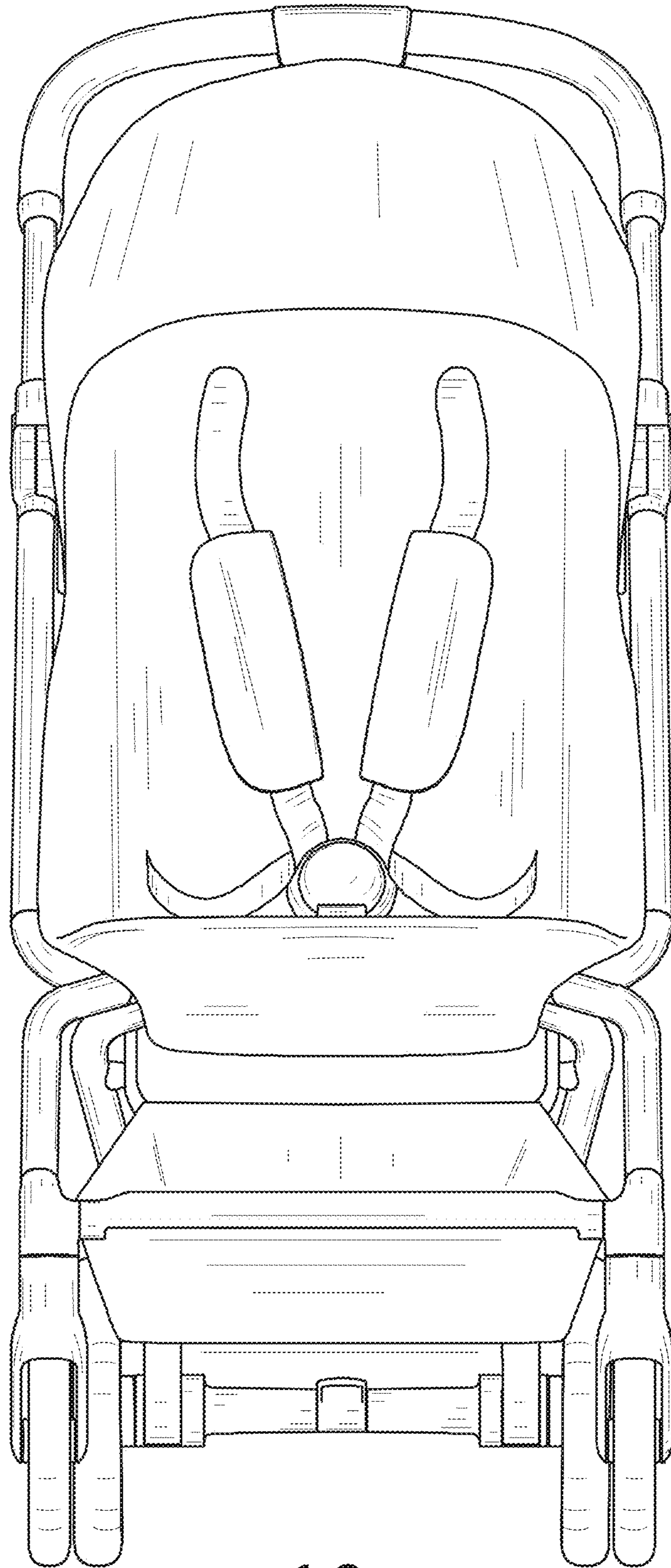

1.2

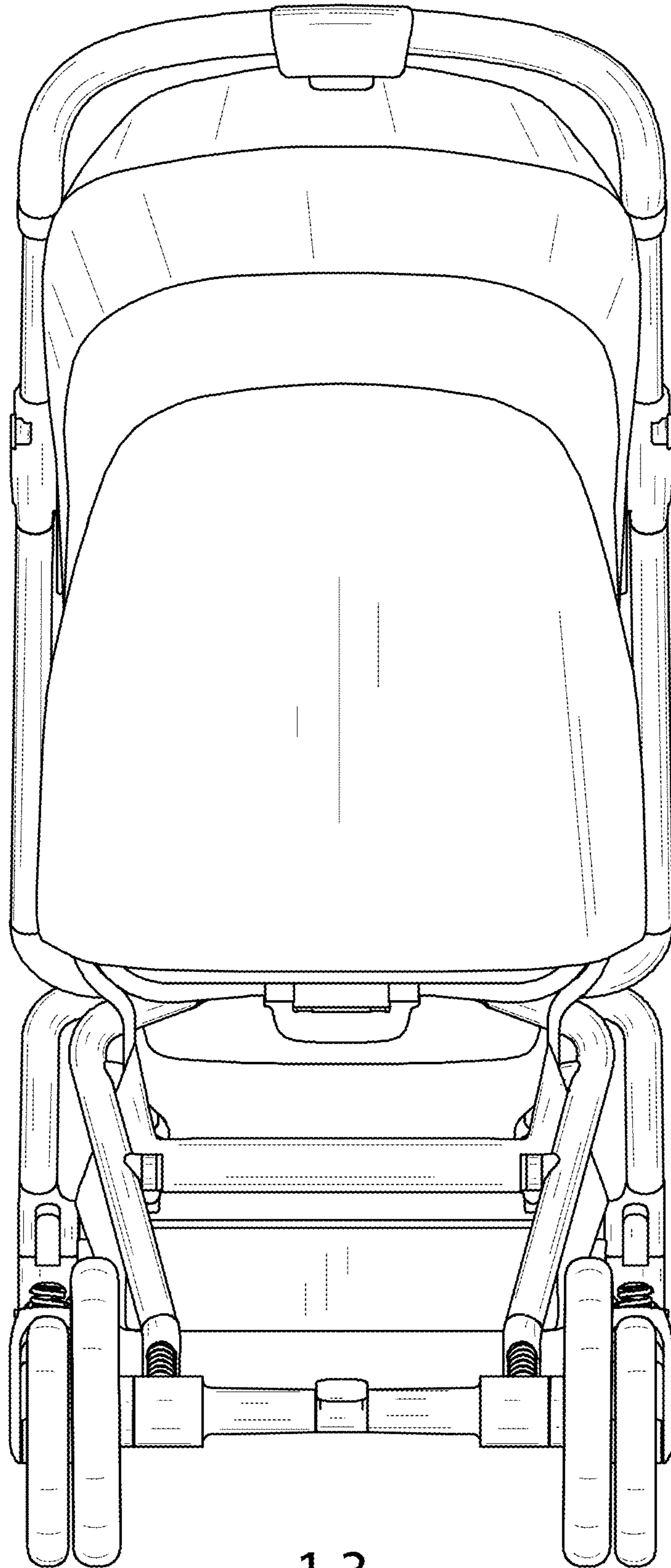

1.3

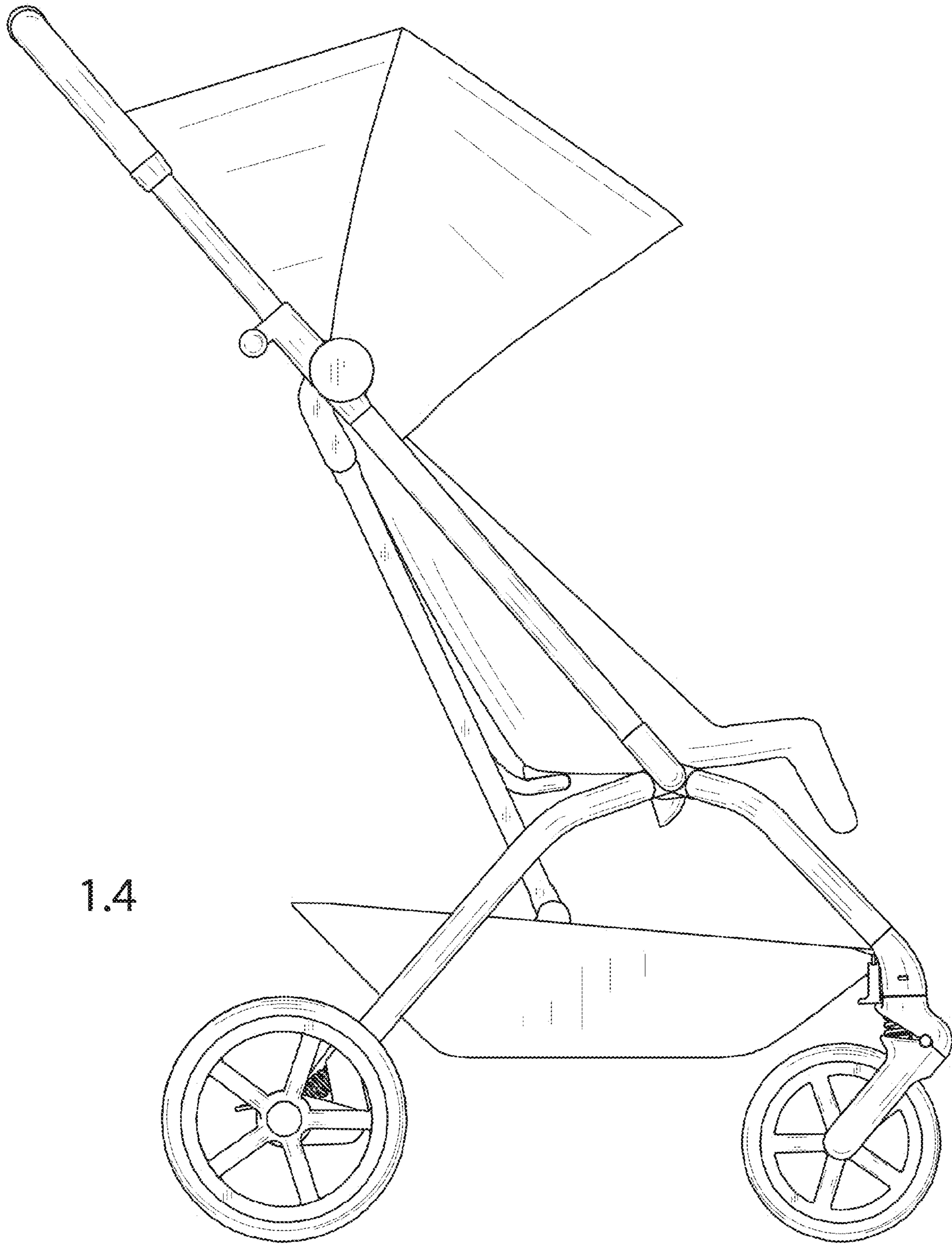

1.4

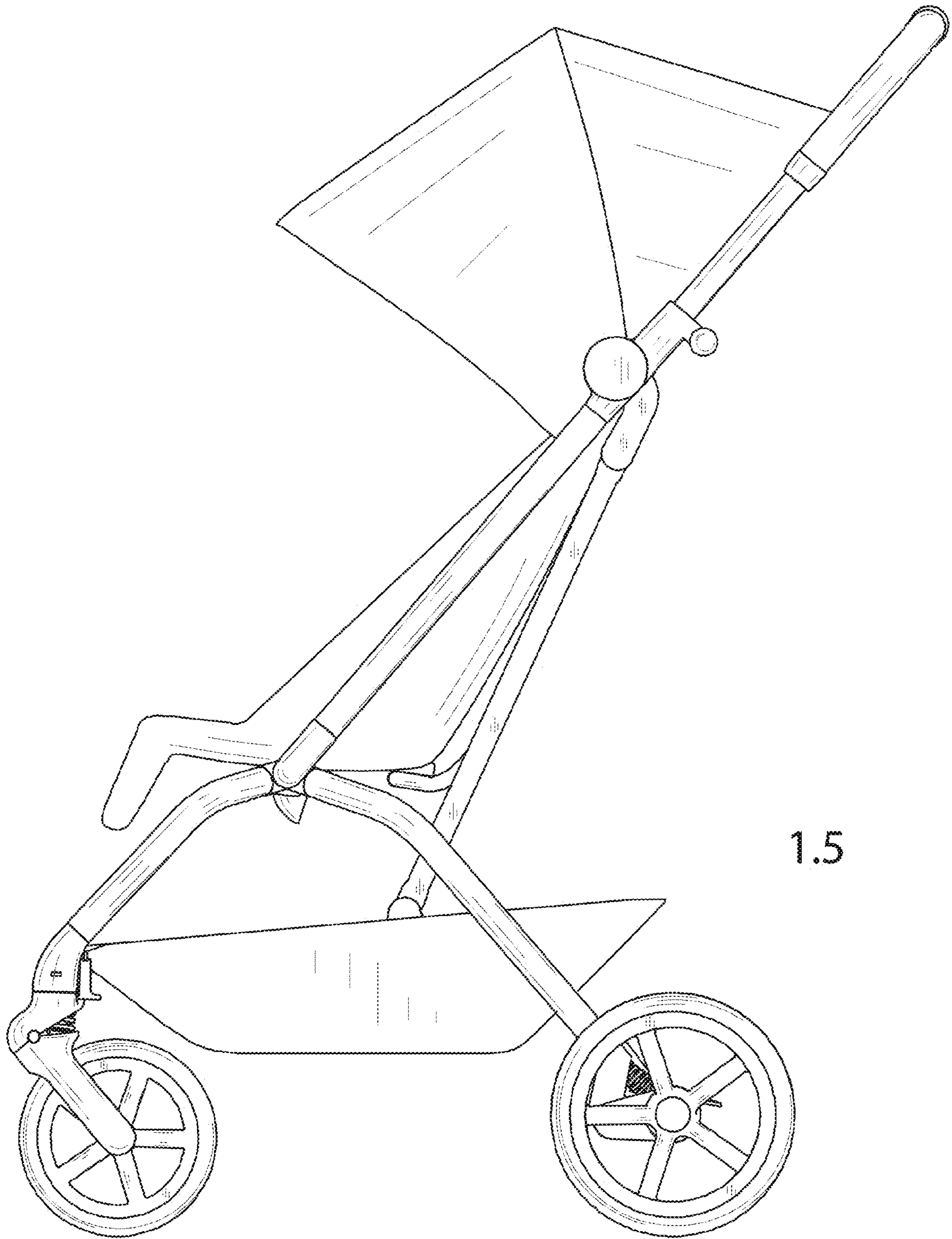

1.5

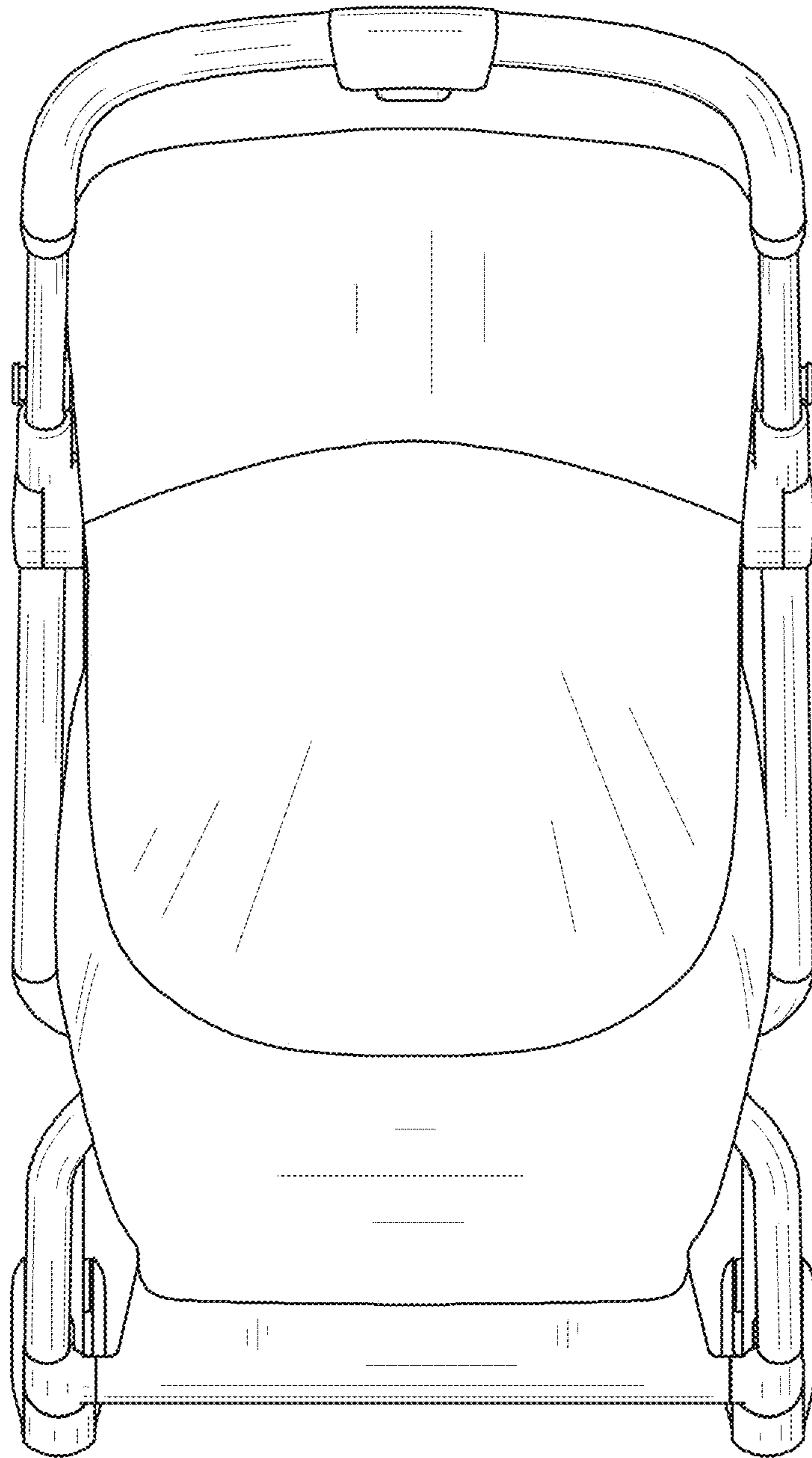

1.6

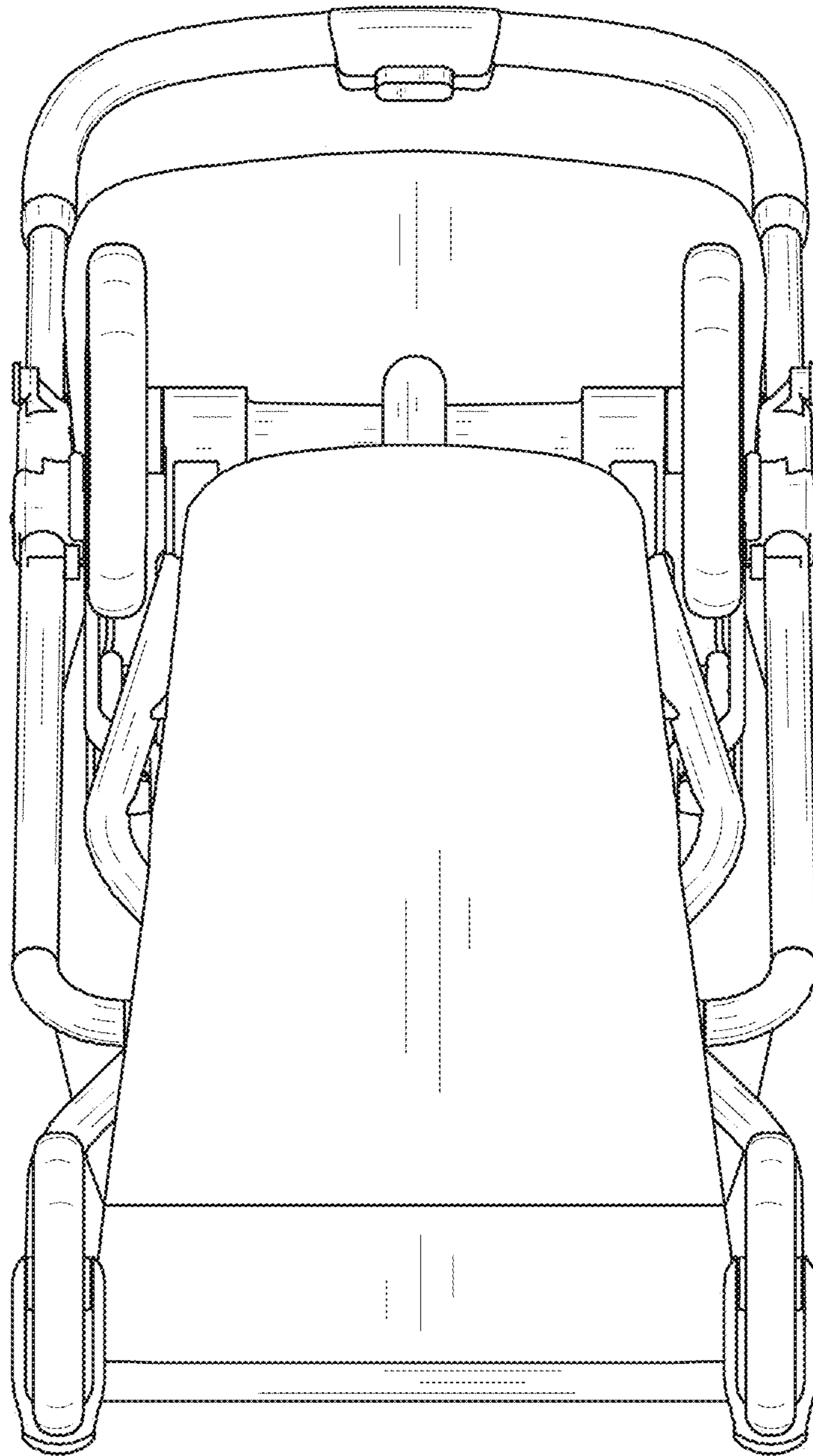

1.7