



US00D893329S

(12) **United States Design Patent** (10) **Patent No.:** **US D893,329 S**
Yang et al. (45) **Date of Patent:** **** *Aug. 18, 2020**

(54) **DIGITAL SCALE**

(71) Applicant: **ETEKCITY CORPORATION**,
Anaheim, CA (US)

(72) Inventors: **Lin Yang**, Shenzhen (CN); **Hai Yang**,
Shenzhen (CN)

(*) Notice: This patent is subject to a terminal disclaimer.

(**) Term: **15 Years**

(21) Appl. No.: **29/673,067**

(22) Filed: **Dec. 11, 2018**

(51) **LOC (12) Cl.** **10-04**

(52) **U.S. Cl.**
USPC **D10/91; D10/92**

(58) **Field of Classification Search**
USPC D10/91, 92
CPC A61B 5/053; A61B 5/4872; A61B 5/0537;
A61B 5/4869; A61B 5/6825; A61B
5/6829; A61B 5/7445; G01G 19/44;
G01G 19/445; G01G 19/46; G01G 19/48;
G01G 19/50; G01G 21/28; G01G 21/283;
G01G 19/286; G01G 19/30; G01G 3/12;
G01G 3/14; G01G 3/1402; G01G 19/021;
G01G 19/03; G01G 23/012; G01G 19/02;
G01G 19/022; G01G 19/024; G01G
19/025; G01G 19/027; G01G 21/44;
G01G 21/286; G01G 21/30; G01G 21/37;
G01G 23/3728; G01G 23/3735; A61G
7/0527

See application file for complete search history.

(56) **References Cited**

U.S. PATENT DOCUMENTS

D678,095	S	*	3/2013	Renner	D10/91
D805,937	S	*	12/2017	Chang	D10/92
10,194,828	B2	*	2/2019	Petrucelli	A61B 5/0537
D865,552	S	*	11/2019	Ying	A61B 5/0537 D10/92

* cited by examiner

Primary Examiner — Antoine Duval Davis

(74) *Attorney, Agent, or Firm* — Tsz Lung Yeung

(57) **CLAIM**

The ornamental design for a digital scale, as shown and described.

DESCRIPTION

FIG. 1 is a front perspective view of a digital scale showing my new design;
FIG. 2 is a front view thereof;
FIG. 3 is a rear view thereof;
FIG. 4 is a right side view thereof;
FIG. 5 is a left side view thereof;
FIG. 6 is a top view thereof;
FIG. 7 is a bottom view thereof; and,
FIG. 8 is a bottom perspective view.
The broken lines in the figures illustrate portions of the digital scale that form no part of the claimed design.

1 Claim, 6 Drawing Sheets

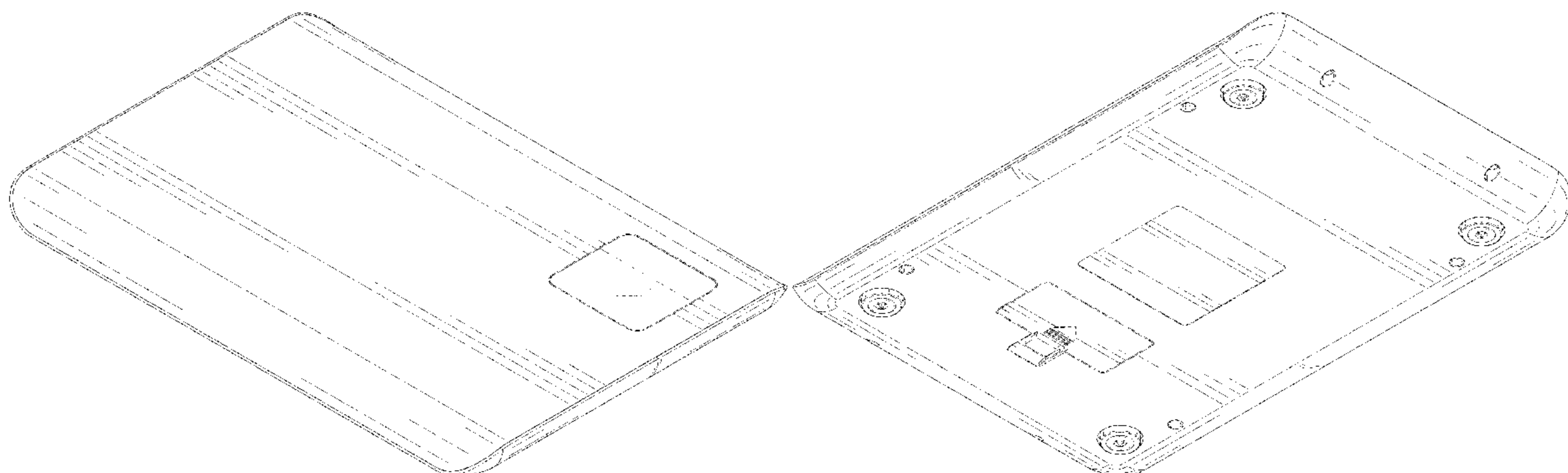

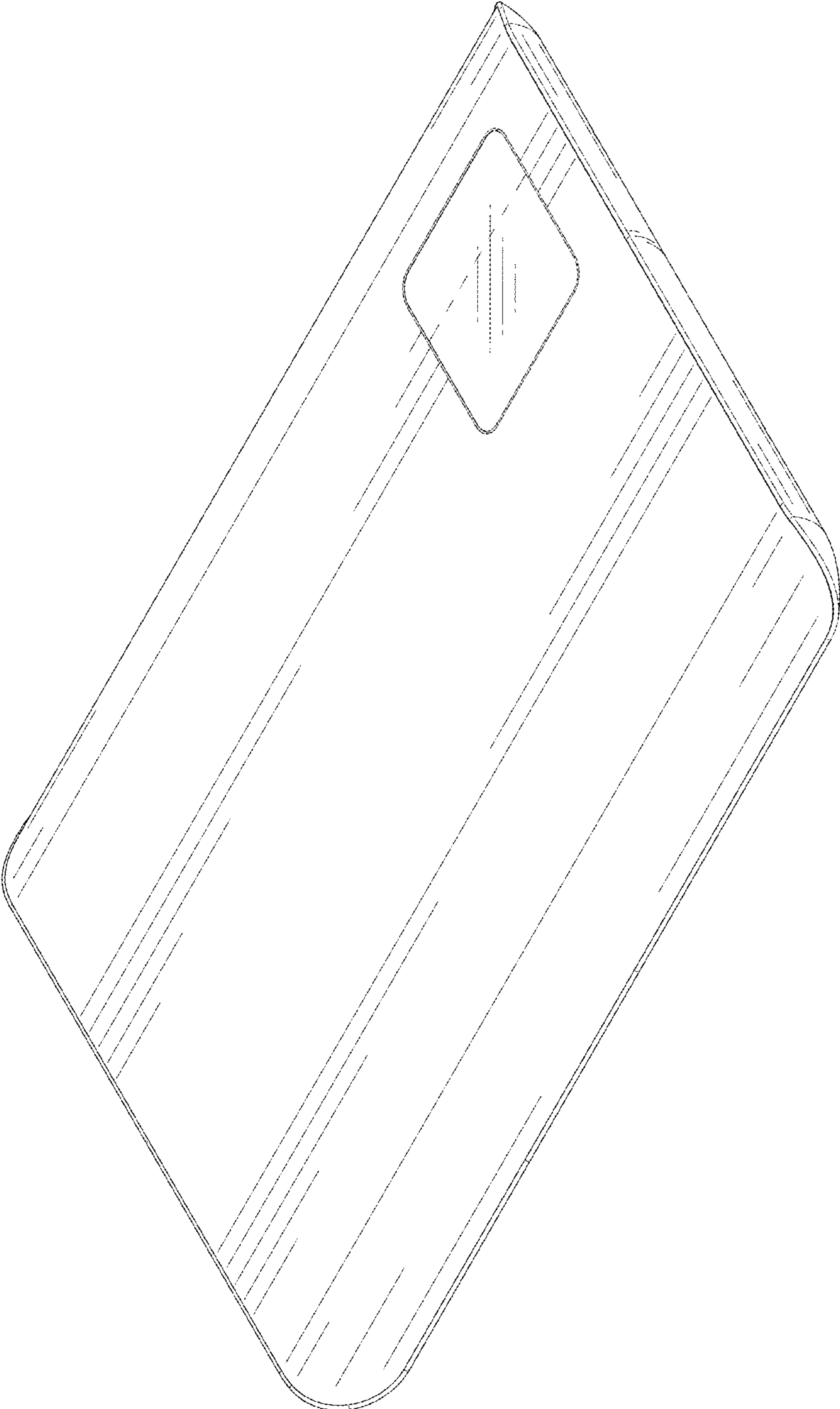

FIG. 1

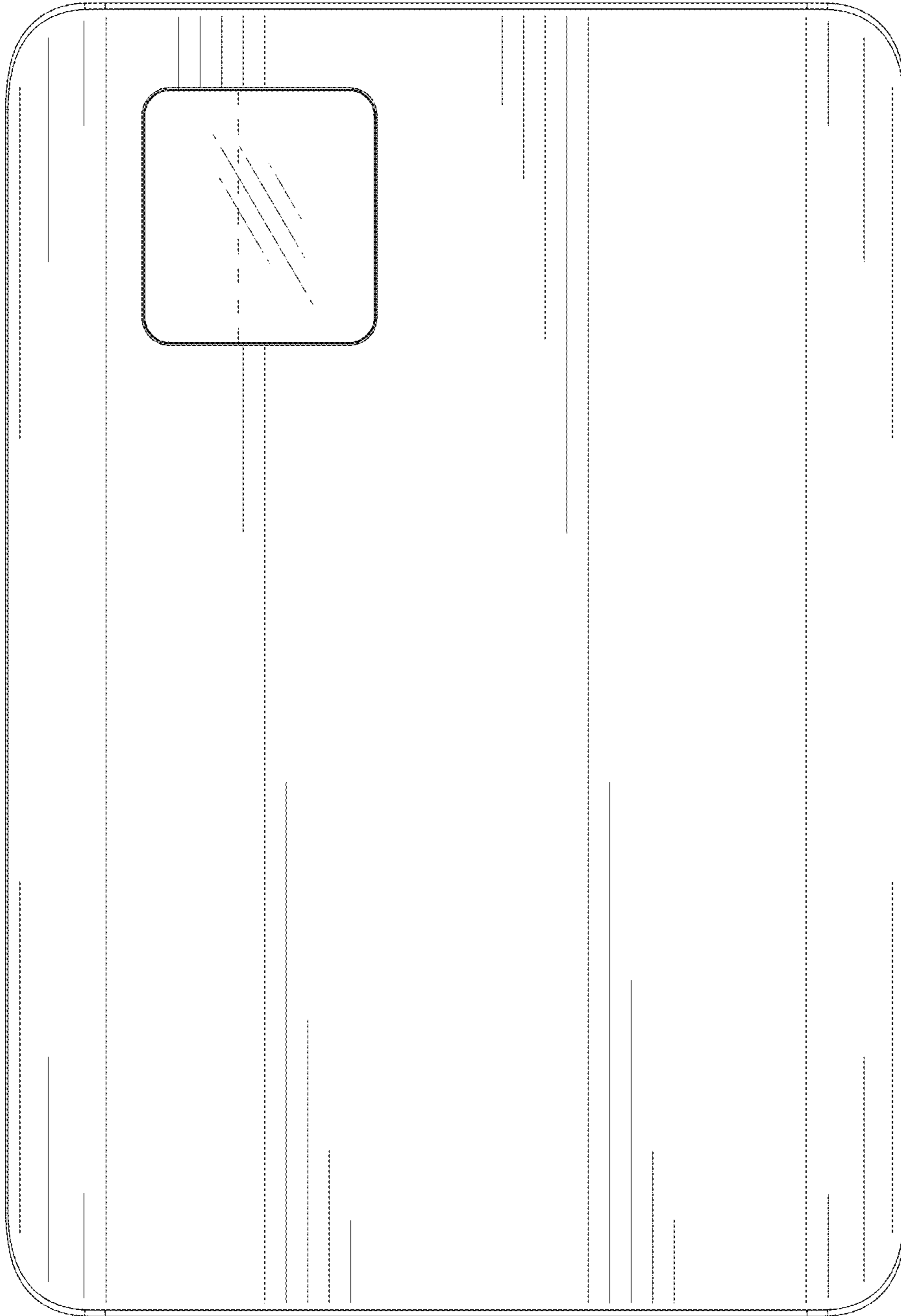

FIG. 2

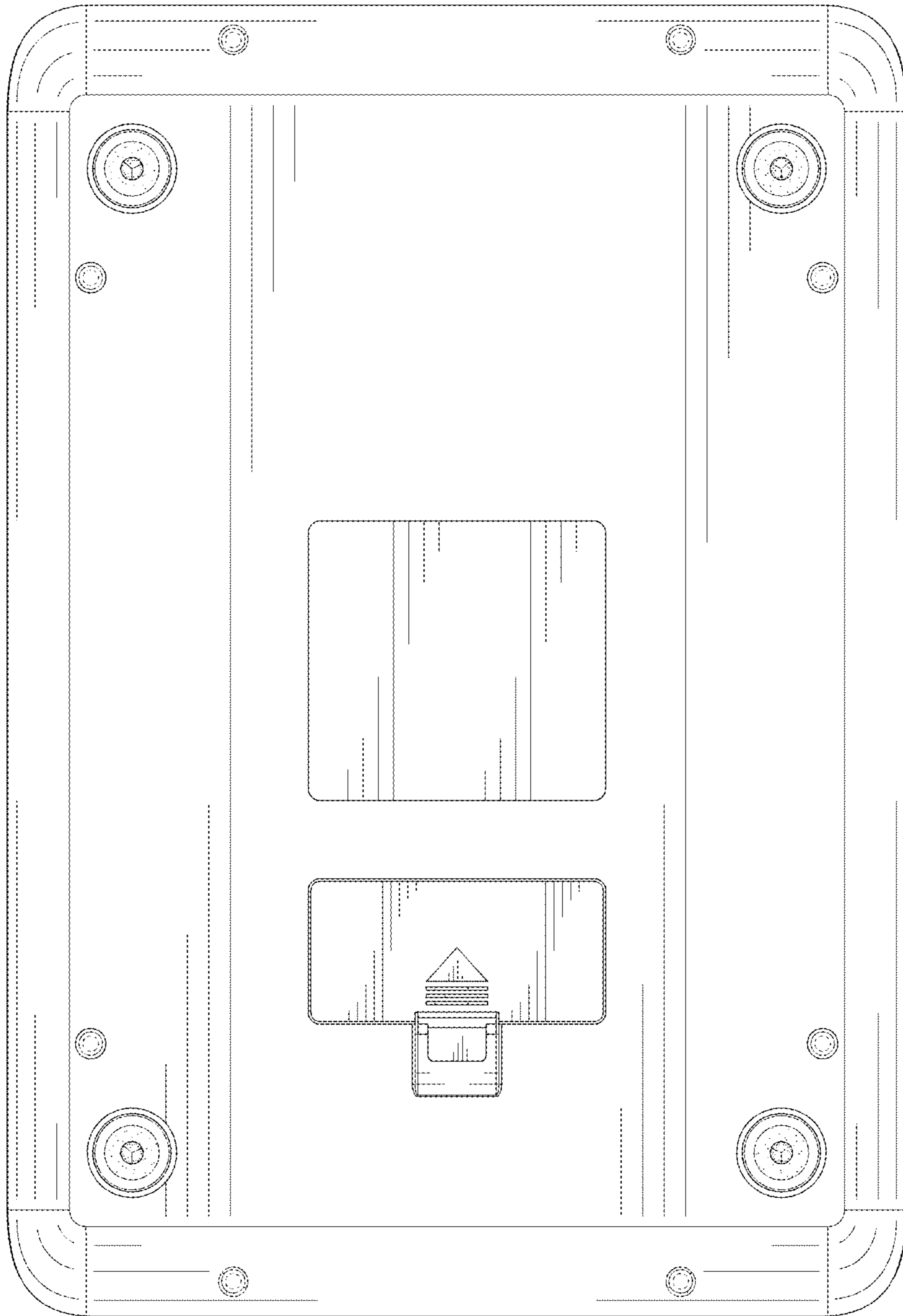

FIG. 3

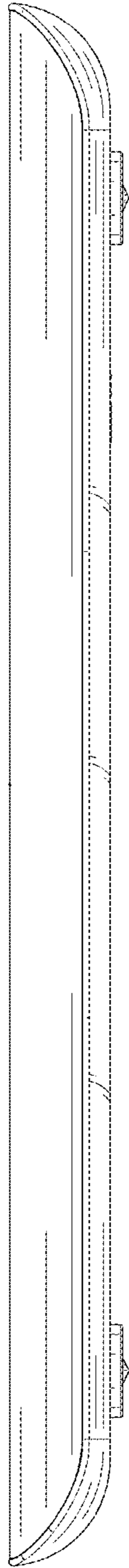

FIG. 4

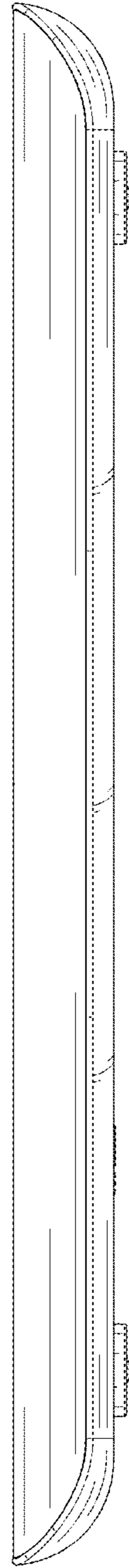

FIG. 5

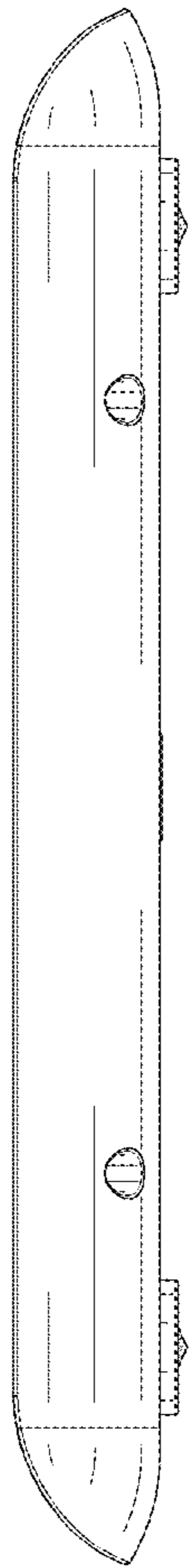

FIG. 6

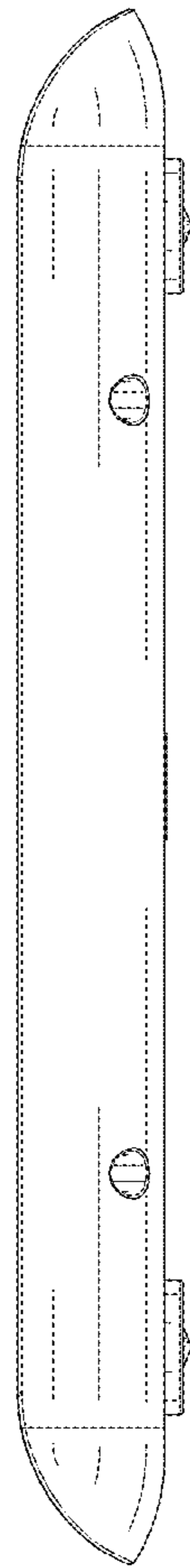

FIG. 7

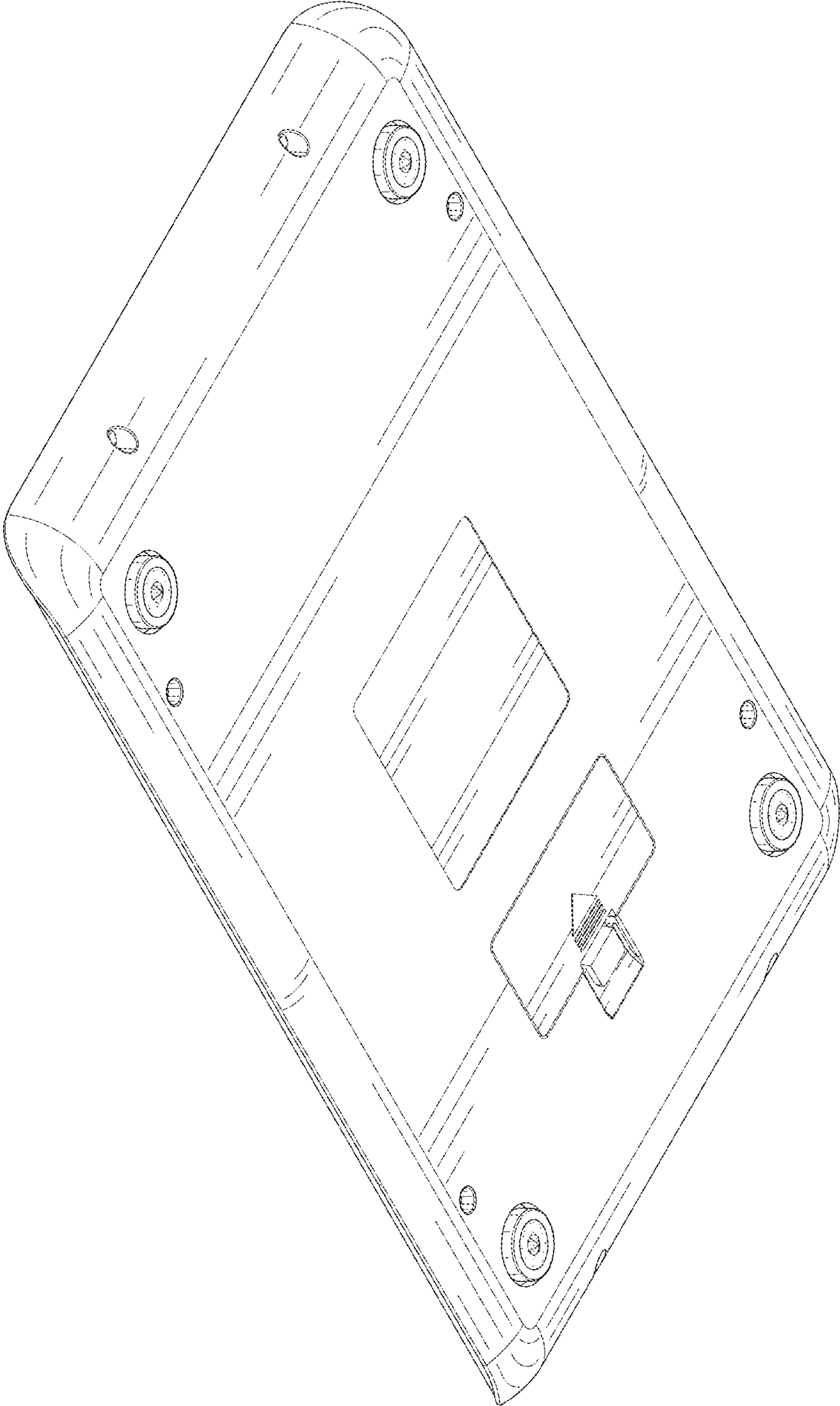

FIG. 8