



US00D893299S

(12) **United States Design Patent** (10) **Patent No.:** **US D893,299 S**
Kaye et al. (45) **Date of Patent:** **** Aug. 18, 2020**

(54) **BOTTLE**

(71) Applicant: **Henkel IP & Holding GmbH**,
Duesseldorf (DE)

(72) Inventors: **Glenn W. Kaye**, Stamford, CT (US);
Elizabeth Meriwether Boyd, Auburn,
AL (US); **George William Hann, II**,
Tolland, CT (US)

(73) Assignee: **Henkel IP & Holding GmbH** (DE)

(**) Term: **15 Years**

(21) Appl. No.: **29/646,696**

(22) Filed: **May 7, 2018**

(51) **LOC (12) Cl.** **09-01**

(52) **U.S. Cl.**

USPC **D9/500**

(58) **Field of Classification Search**

USPC D9/434–435, 444–445, 454, 500,
D9/503–504, 516, 530, 537, 539, 549,
D9/558, 715, 719; D7/509–511, 523, 608
CPC B65D 1/00; B65D 1/02; B65D 1/0223;
B65D 23/00; B65D 81/00; B65D
2501/00; B65D 2501/0009

See application file for complete search history.

(56) **References Cited**

U.S. PATENT DOCUMENTS

D220,560 S *	4/1971	Johnson	D9/504
D229,168 S *	11/1973	Silfand	D9/504
D375,655 S *	11/1996	King	D7/510
D426,773 S *	6/2000	Warner	D9/449
D436,501 S *	1/2001	Huang	D7/608
D441,872 S *	5/2001	Johansen	D24/197
D447,693 S *	9/2001	Warner	D9/450
D454,282 S *	3/2002	Mano	D7/608
D456,218 S *	4/2002	Hatsumoto	D7/608
D513,185 S *	12/2005	Ruiz	D1/105

D528,001 S *	9/2006	Schroeder	D9/502
D533,064 S *	12/2006	Glynn	D9/500
D539,095 S *	3/2007	Snyder	D7/597
D553,003 S *	10/2007	Baker	D9/691
D562,696 S *	2/2008	Baker	D9/691
D562,697 S *	2/2008	Baker	D9/691
D568,155 S *	5/2008	Glydon	D9/500
D580,765 S *	11/2008	Amann	D9/504
D604,641 S *	11/2009	Renz	D9/500
D609,094 S *	2/2010	Kim	D9/453

(Continued)

Primary Examiner — Dana Meyrow

(74) *Attorney, Agent, or Firm* — Bojuan Deng

(57) **CLAIM**

The ornamental design for bottle, as shown and described.

DESCRIPTION

FIG. 1 is a front perspective view of one embodiment of a bottle embodying the new design; FIG. 2 is a front side elevation view thereof; FIG. 3 is a rear side elevation view thereof; FIG. 4 is a right side elevation view thereof; FIG. 5 is a left side elevation view thereof; FIG. 6 is a top plan view thereof and, FIG. 7 is a bottom plan view thereof; FIG. 8 is a front perspective view of another embodiment of a bottle embodying our new design; FIG. 9 is a front side elevation view thereof; FIG. 10 is a rear side elevation view thereof; FIG. 11 is a right side elevation view thereof; FIG. 12 is a left side elevation view thereof; FIG. 13 is a top plan view thereof; and, FIG. 14 is a bottom plan view thereof. The evenly-dashed broken lines in the drawings illustrate the portions of the bottle that form no part of the claimed design. The dot-dash broken lines in the drawings define the bounds of the claim and form no part thereof.

1 Claim, 12 Drawing Sheets

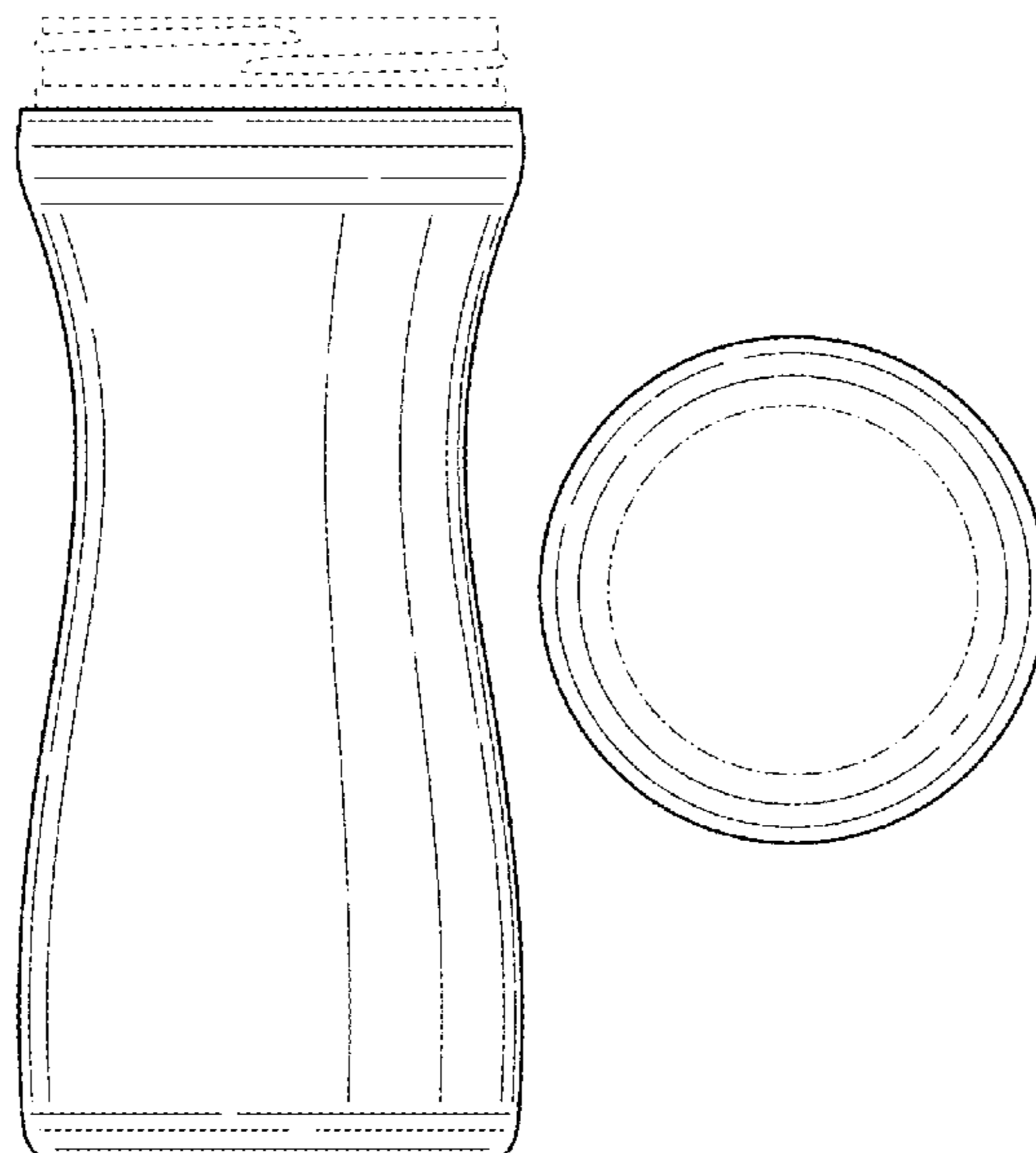

(56)

References Cited

U.S. PATENT DOCUMENTS

7,810,651	B2 *	10/2010	Miga, Jr.	C02F 1/002 210/266
D626,417	S *	11/2010	Kim	D9/453
D628,486	S *	12/2010	Lane	D7/510
D633,808	S *	3/2011	Titherington	B65D 50/041 D9/453
D657,194	S *	4/2012	McIntire	D7/510
D661,987	S *	6/2012	Broen	D9/435
D664,439	S *	7/2012	Malm	D9/540
D674,279	S *	1/2013	Lembke	D7/509
D686,453	S *	7/2013	Smiedt	D7/510
D686,918	S *	7/2013	Lembke	D9/500
D740,609	S *	10/2015	Ayres	D7/523
D796,261	S *	9/2017	Khalifa	D7/392.1
D803,059	S *	11/2017	Matthieu	D9/500
D807,179	S *	1/2018	Herbst	D9/500
D823,475	S *	7/2018	Brown	D24/197
D828,165	S *	9/2018	Haughton	D9/503
D829,054	S *	9/2018	Breit	D7/510
D851,457	S *	6/2019	Han	D7/510
D858,199	S *	9/2019	Burns	D7/511
2013/0201784	A1 *	8/2013	Hauser	B01F 13/0022 366/130

* cited by examiner

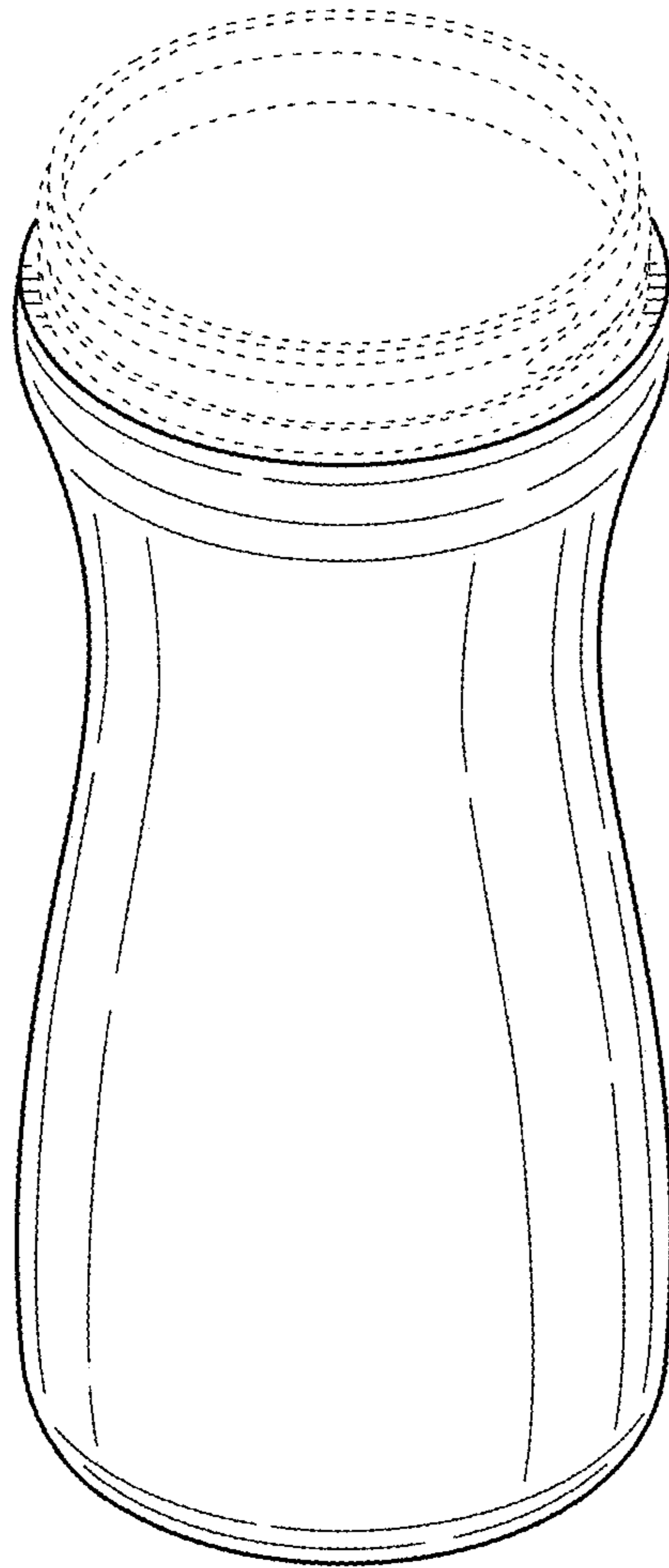

FIG. 1

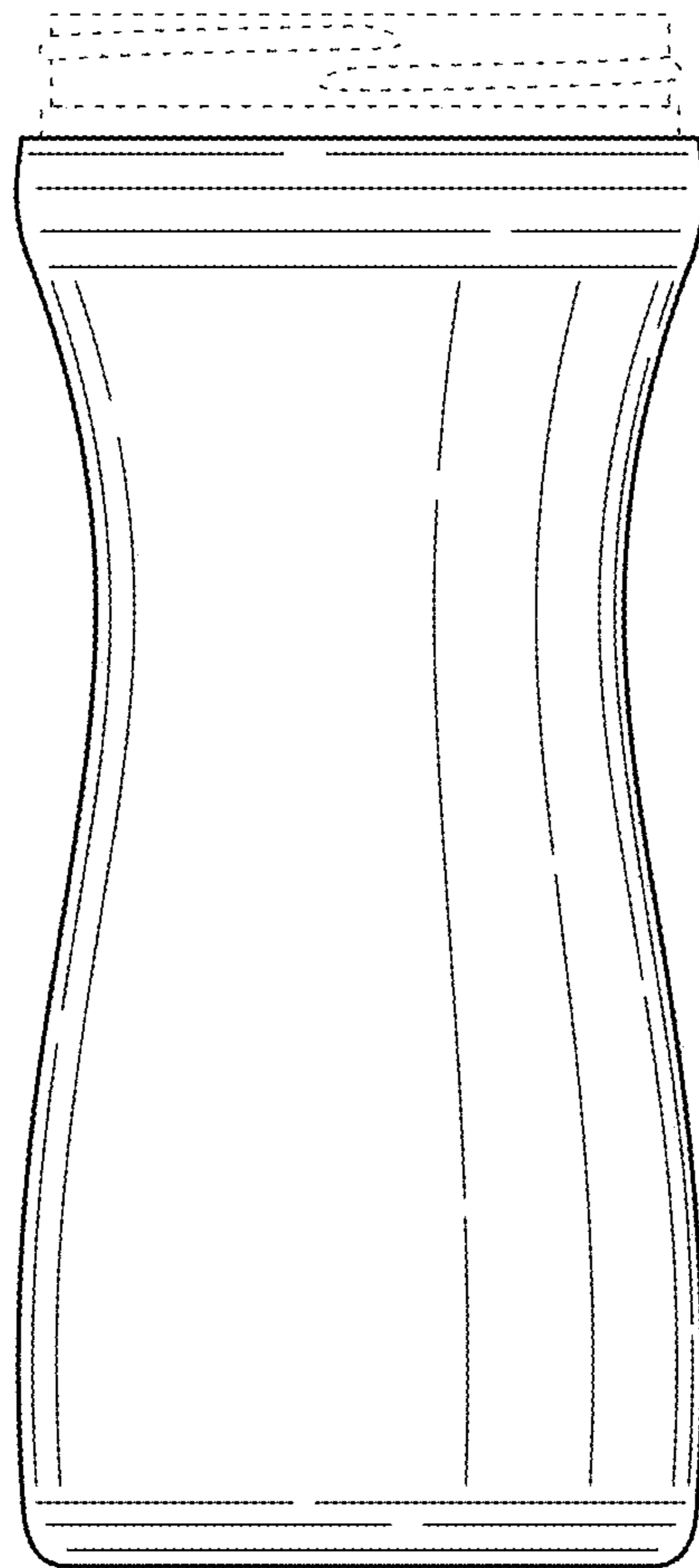

FIG. 2

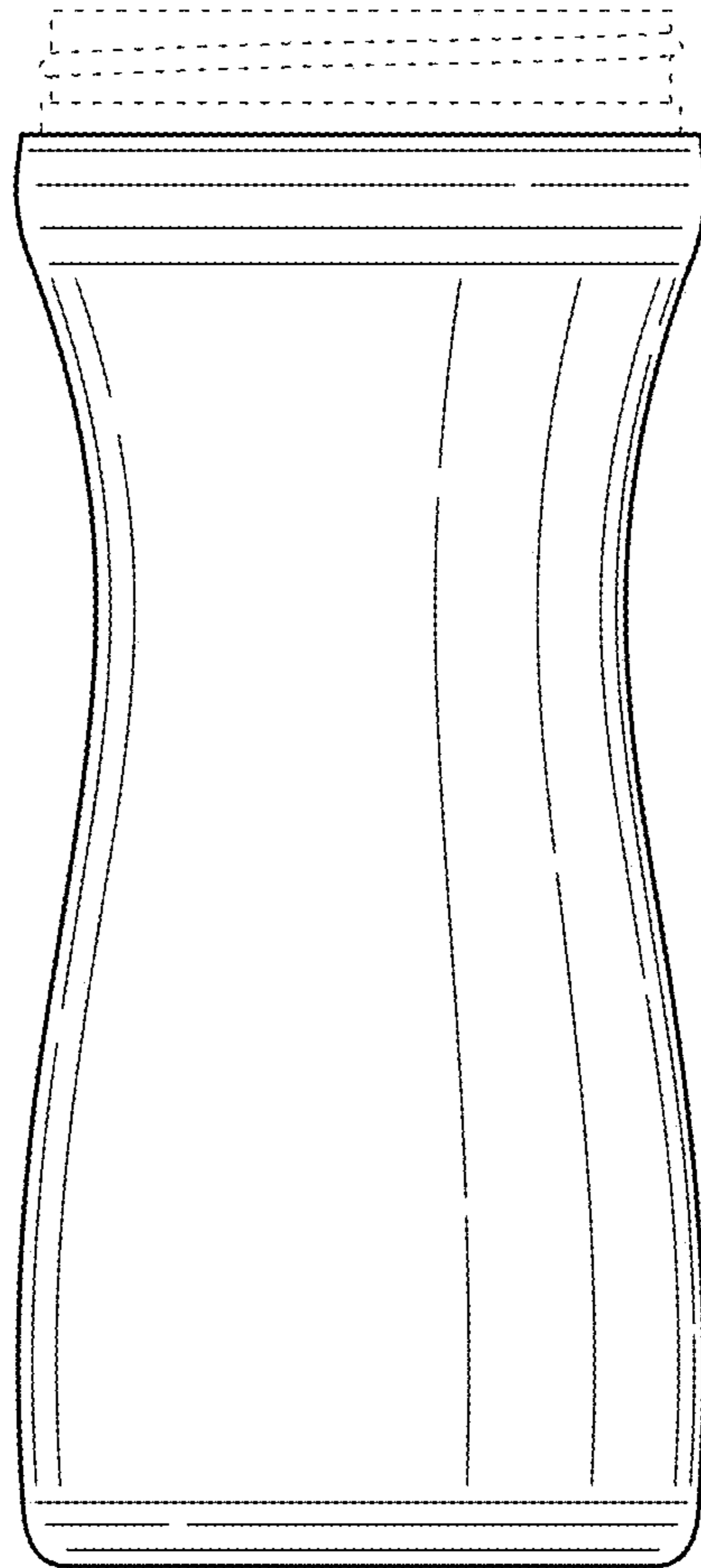

FIG. 3

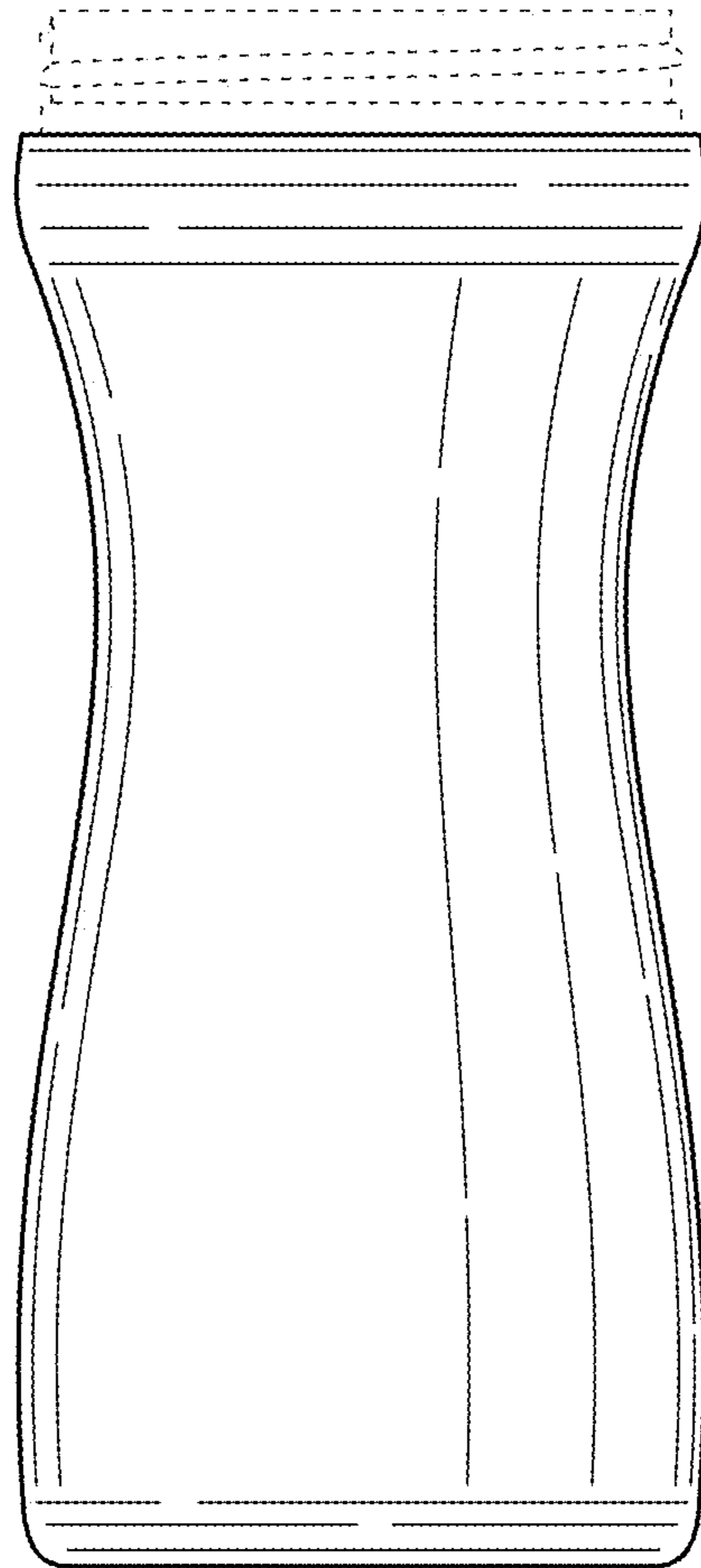

FIG. 4

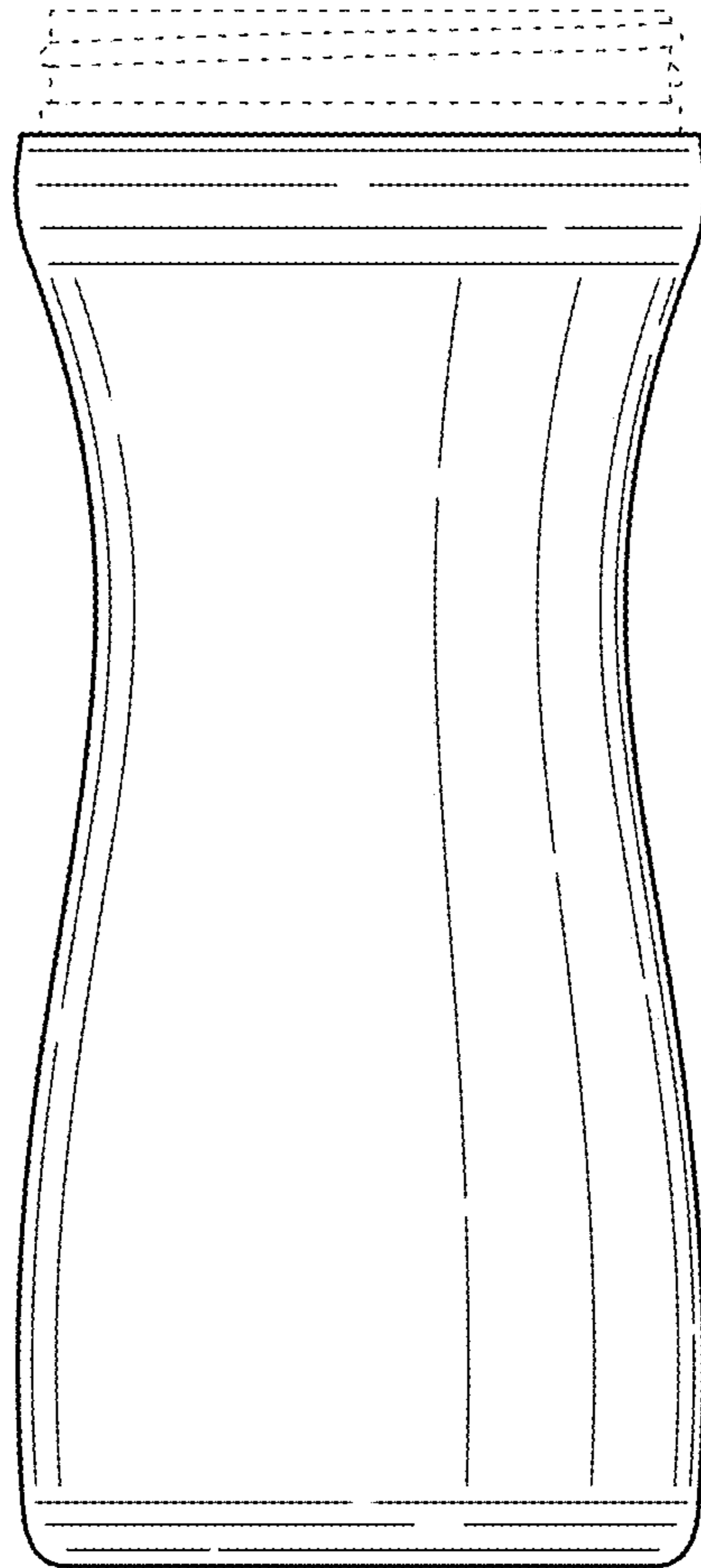

FIG. 5

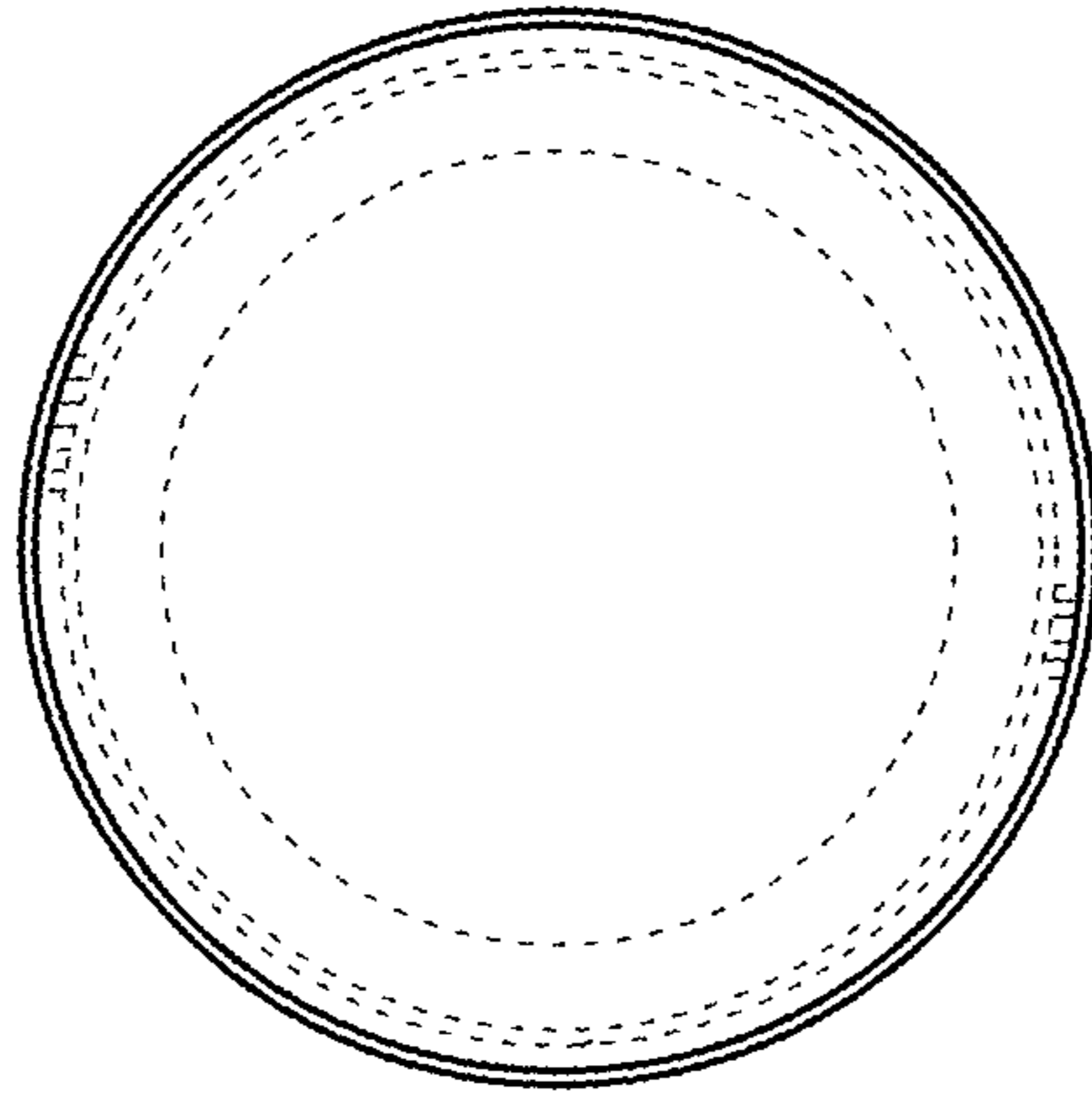

FIG. 6

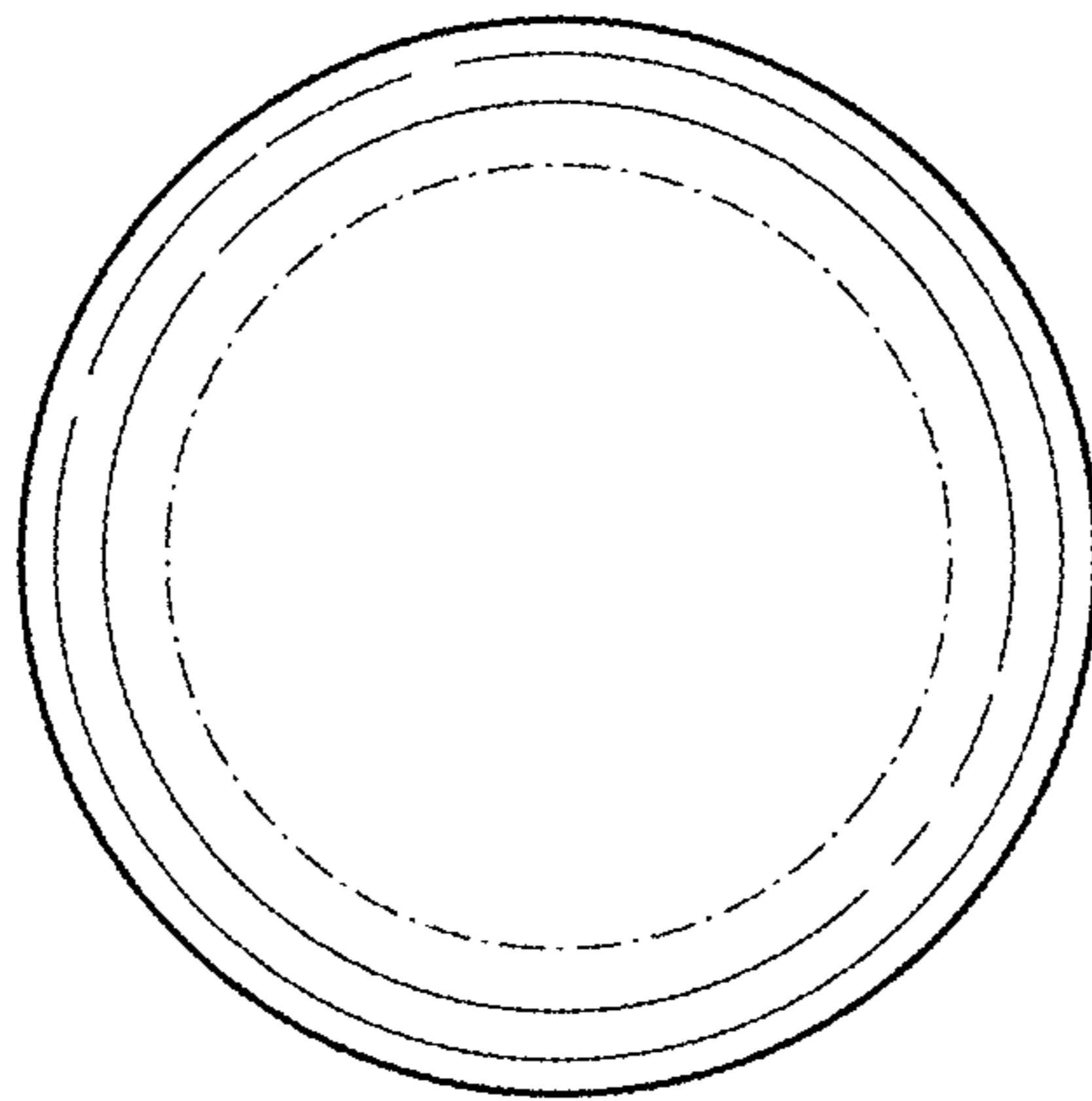

FIG. 7

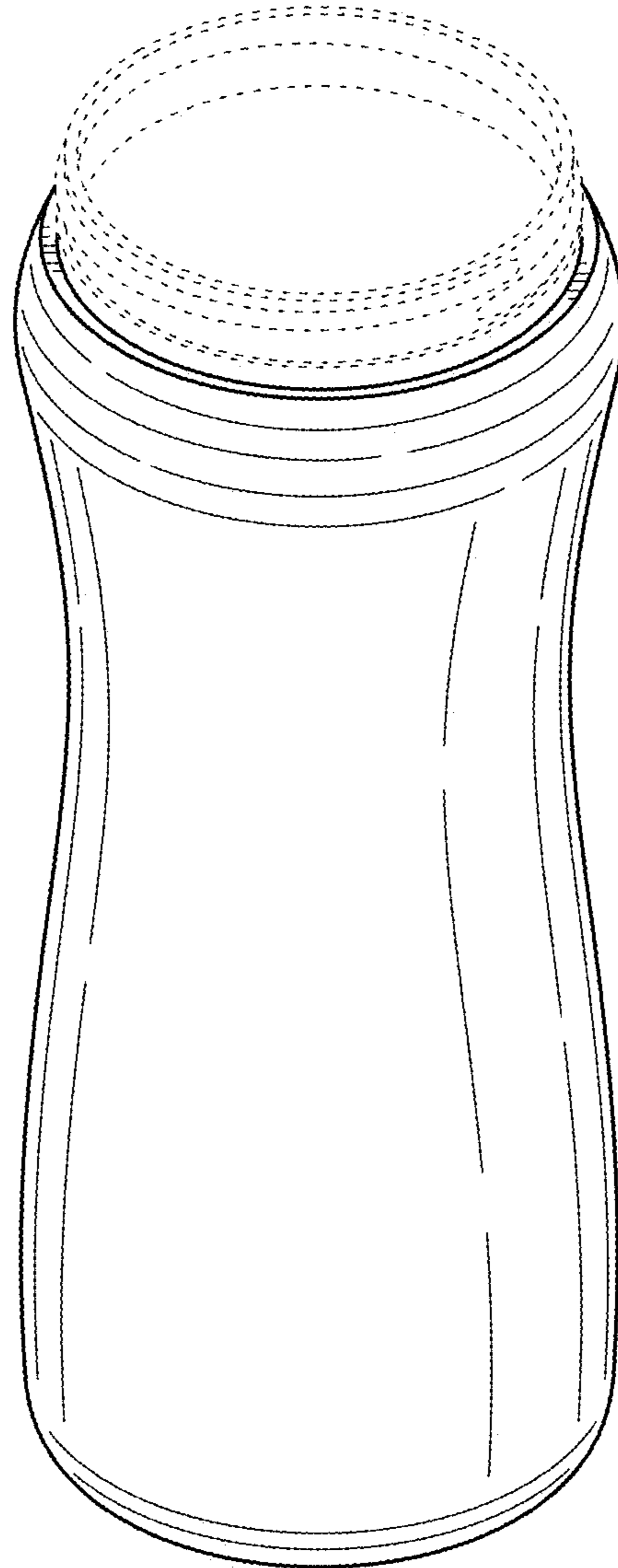

FIG. 8

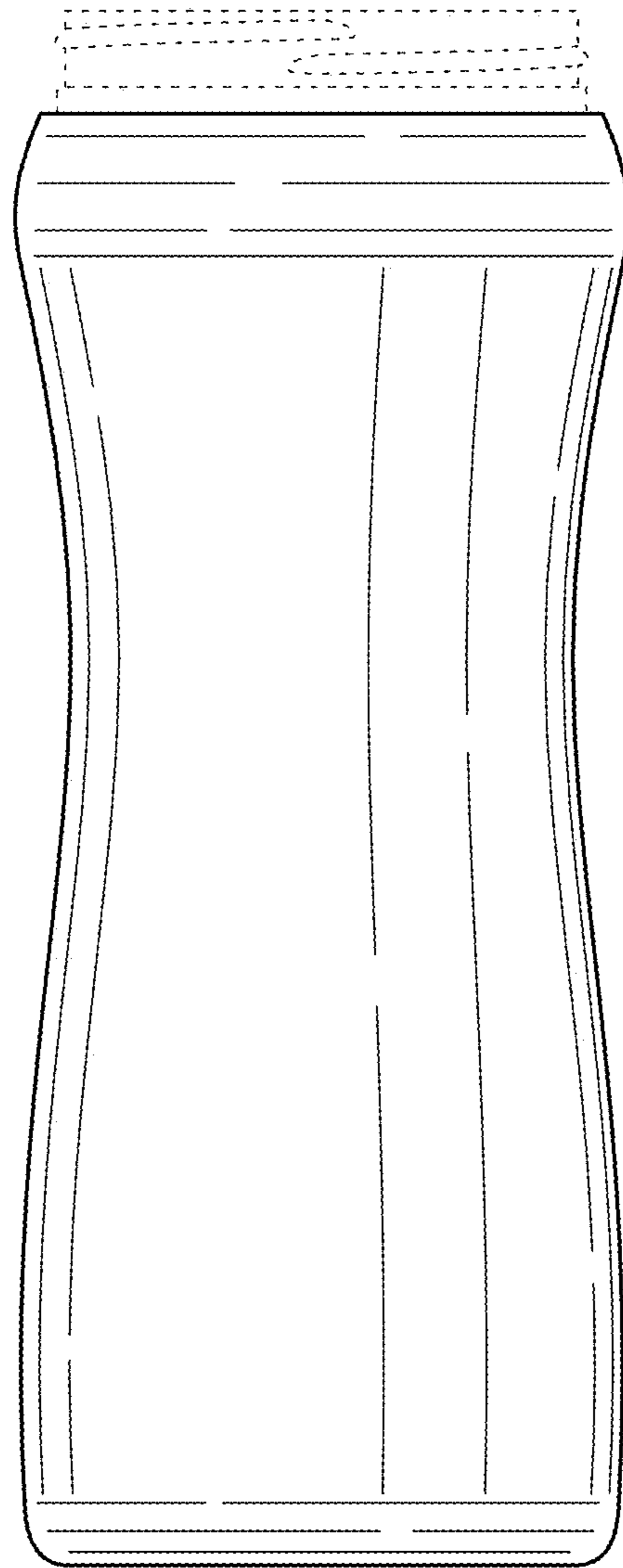

FIG. 9

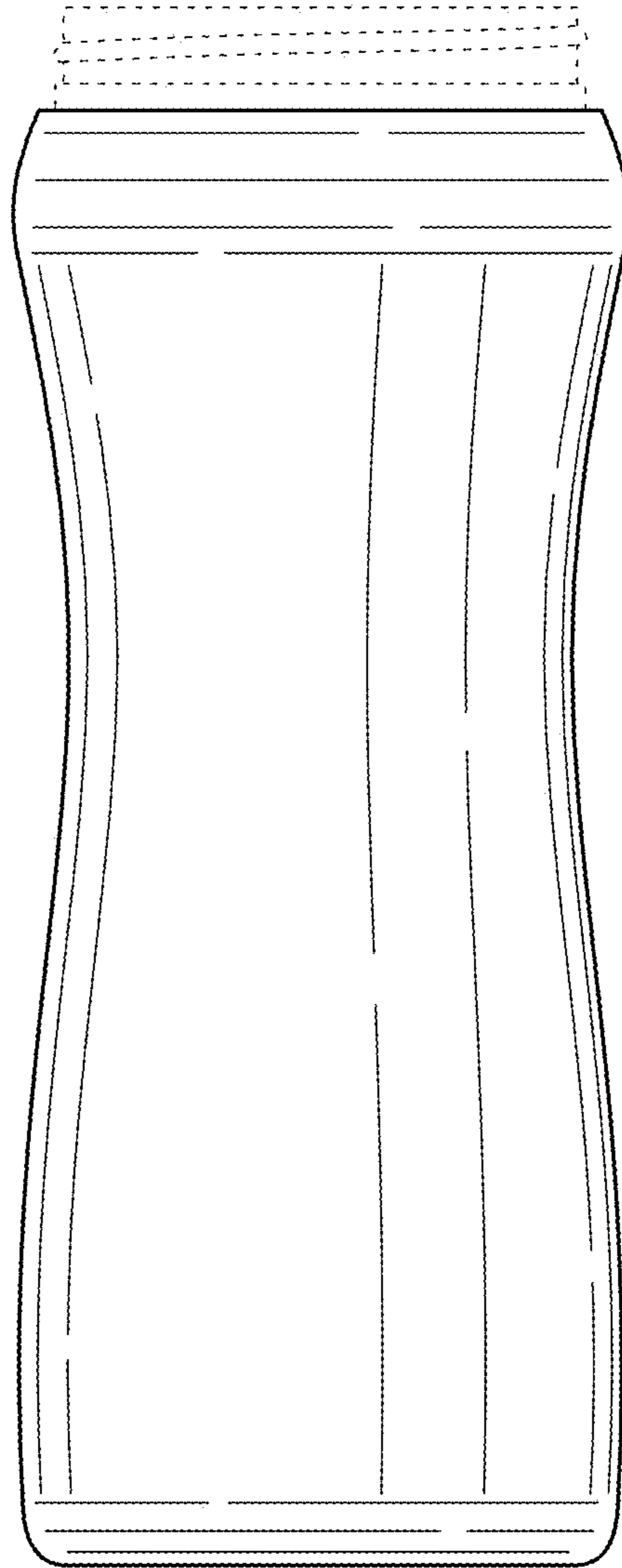

FIG. 10

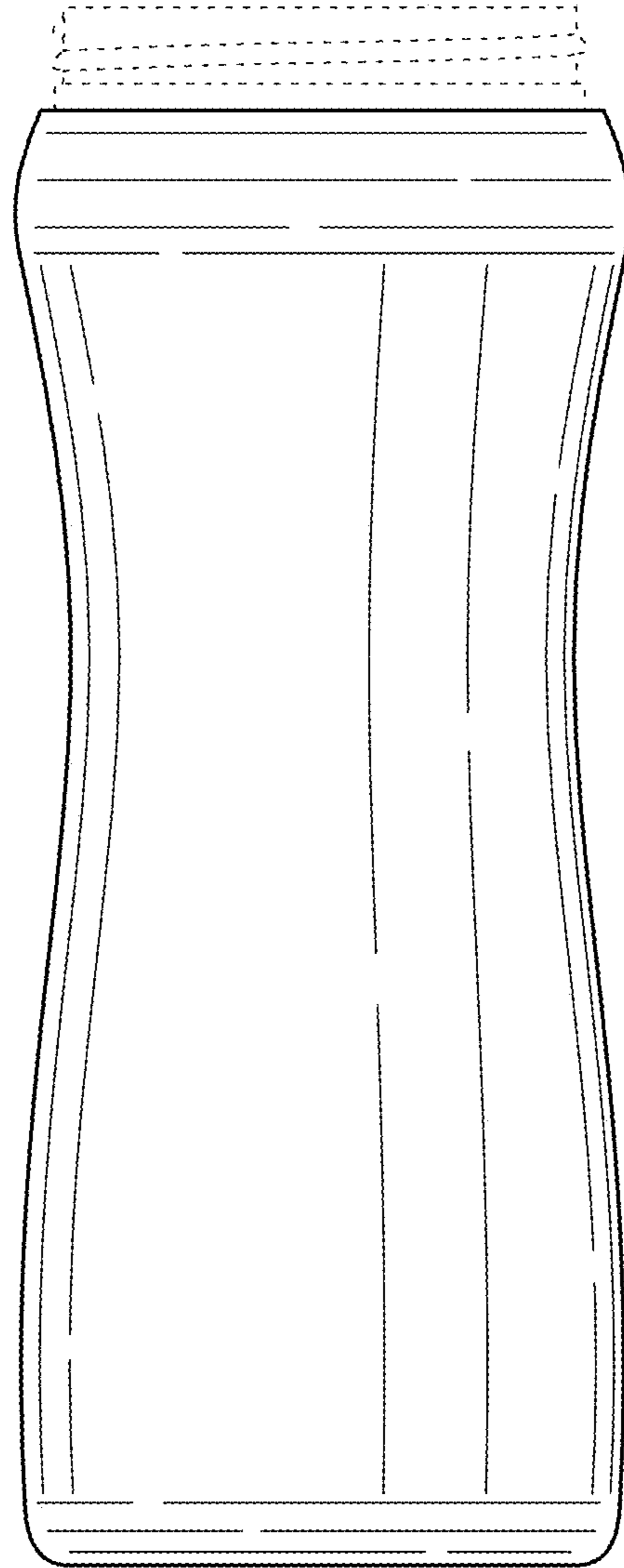

FIG. 11

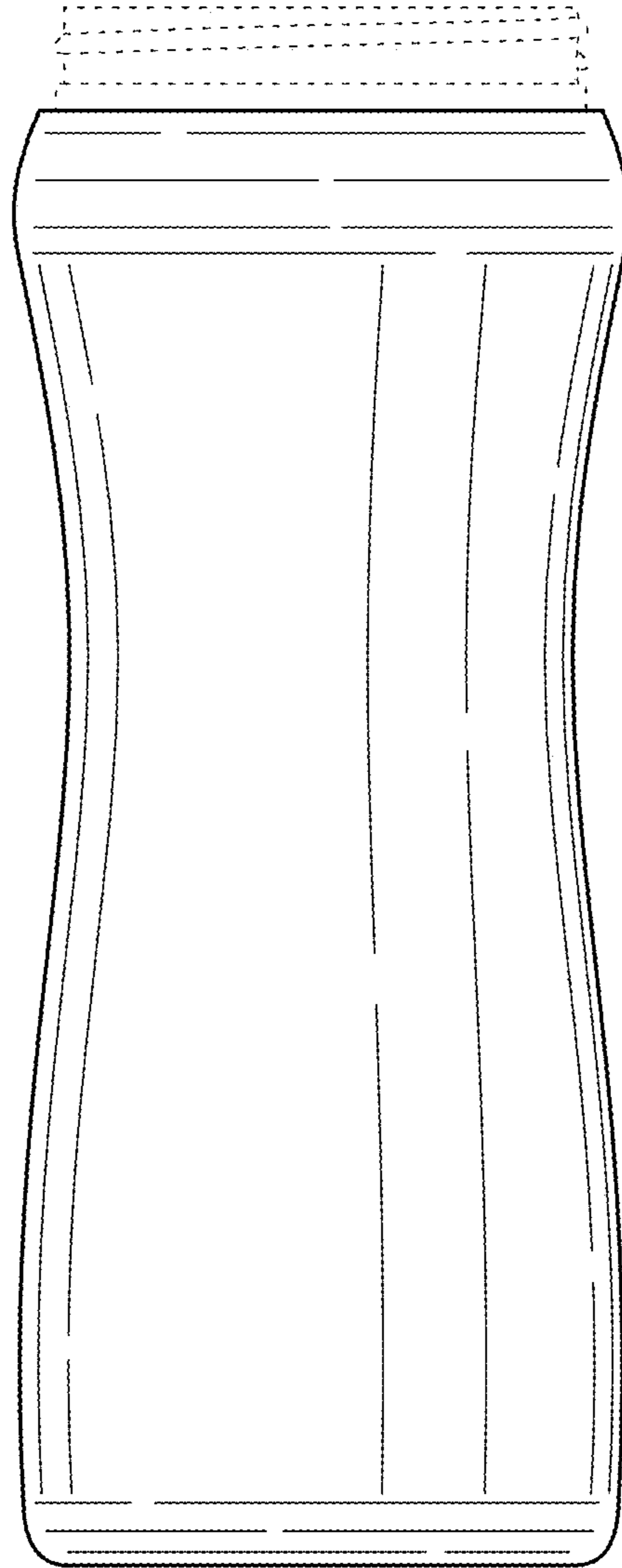

FIG. 12

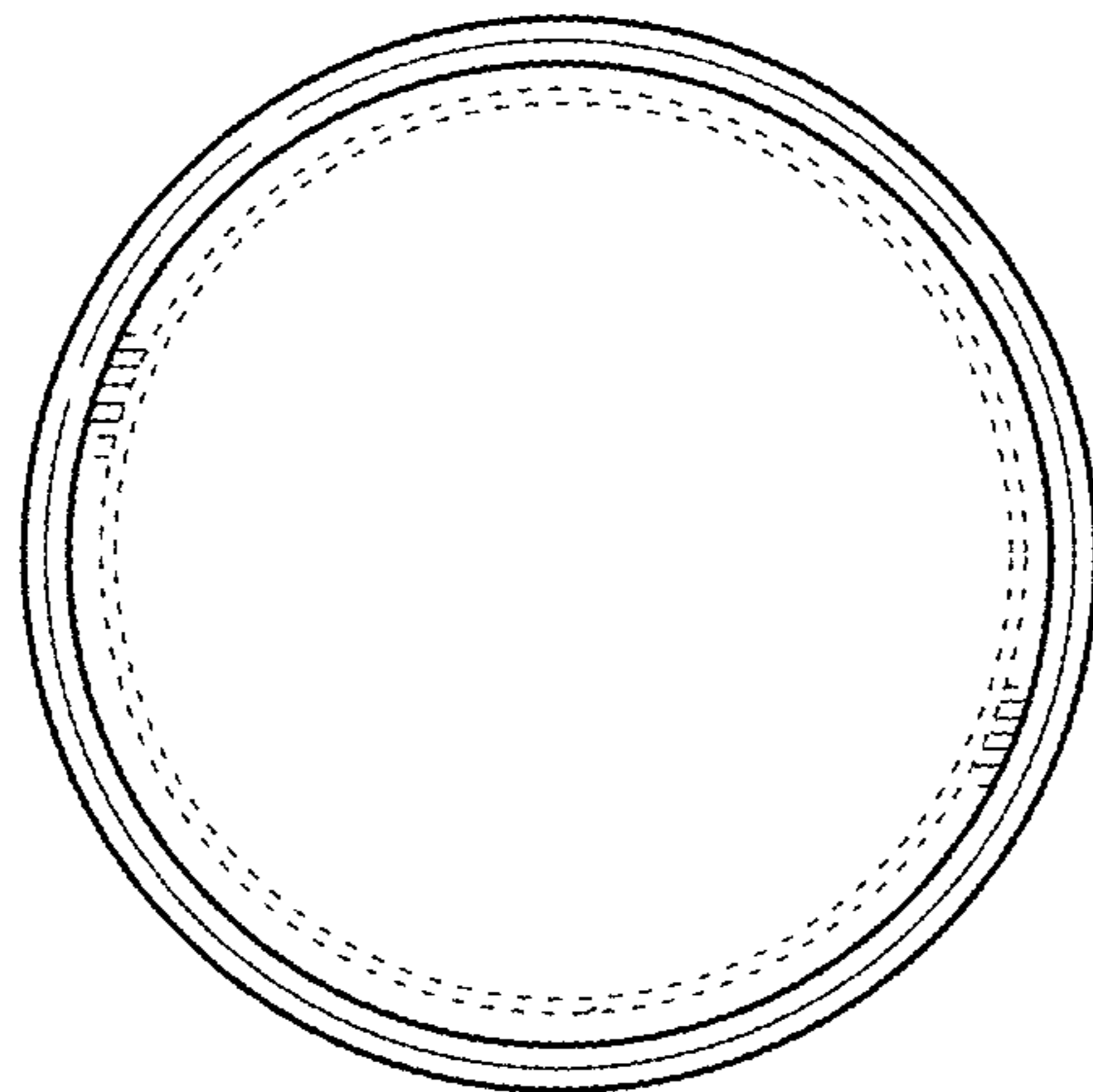

FIG.13

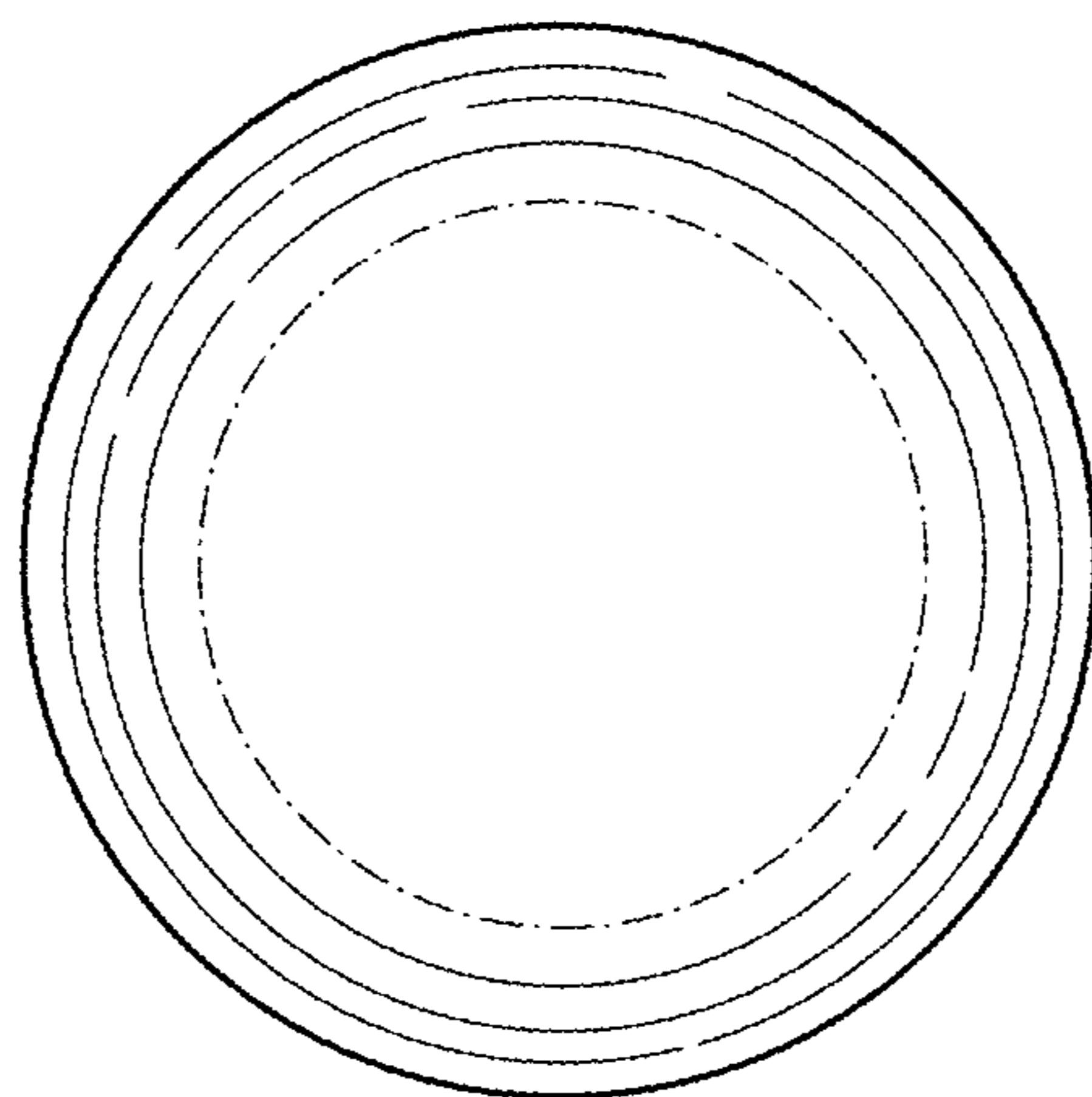

FIG.14