



US00D893272S

(12) **United States Design Patent** (10) **Patent No.:** **US D893,272 S**
Su (45) **Date of Patent:** **** Aug. 18, 2020**

(54) **RATCHET WRENCH HANDLE**
(71) Applicant: **Hong Ann Tool Industries Co., Ltd., Taichung (TW)**
(72) Inventor: **Cheng-Wei Su, Taichung (TW)**
(73) Assignee: **Hong Ann Tool Industries Co., Ltd., Taichung (TW)**
(**) Term: **15 Years**
(21) Appl. No.: **29/673,110**
(22) Filed: **Dec. 12, 2018**
(51) **LOC (12) Cl.** **08-05**
(52) **U.S. Cl.**
USPC **D8/25**
(58) **Field of Classification Search**
USPC D8/14, 21, 25, 28, 29, 107
CPC B25B 13/02; B25B 13/04; B25B 13/46;
B25B 13/461; B25B 13/08; B25B 13/06;
B25B 1/065
See application file for complete search history.

(56) **References Cited**

U.S. PATENT DOCUMENTS

D488,967 S * 4/2004 Hsien D8/21
D525,495 S * 7/2006 Hsieh D8/28
7,168,346 B2 * 1/2007 Lin B25G 1/063
81/177.7
7,246,544 B1 * 7/2007 Lee B25B 13/461
81/177.8
7,281,452 B2 * 10/2007 Chang B25B 13/46
81/177.2
7,318,366 B2 * 1/2008 Lee B25B 13/461
403/93
D601,871 S * 10/2009 Murray B25B 13/06
D8/28
D603,234 S * 11/2009 Lin D8/25
7,878,091 B2 * 2/2011 Abel B25B 13/461
81/177.9

D639,625 S * 6/2011 Chang D8/28
7,975,575 B2 * 7/2011 Hu B25B 13/461
81/177.7
D658,460 S * 5/2012 Wang D8/25
D658,461 S * 5/2012 Wang D8/25
D660,666 S * 5/2012 Chang D8/25
D661,166 S * 6/2012 Christopher D8/25
D687,692 S * 8/2013 Chen D8/28
D756,182 S * 5/2016 Chen D8/25
D760,044 S * 6/2016 Yang D8/21
D799,292 S * 10/2017 Wang D8/25
9,808,917 B1 * 11/2017 Chien B25B 23/0028
2003/0188608 A1 * 10/2003 Hsien B25B 13/08
81/177.8
2010/0326246 A1 * 12/2010 Chang B25B 13/04
81/60
2011/0239827 A1 * 10/2011 Hart B25B 13/04
81/60

(Continued)

Primary Examiner — Philip S Hyder

(74) *Attorney, Agent, or Firm* — Alan D. Kamrath; Karin L. Williams; Mayer & Williams PC

(57) **CLAIM**

The ornamental design for a ratchet wrench handle, as shown and described.

DESCRIPTION

FIG. 1 is a perspective view of a ratchet wrench handle showing my new design;
FIG. 2 is a front view thereof;
FIG. 3 is a rear view thereof;
FIG. 4 is a left view thereof;
FIG. 5 is a right view thereof;
FIG. 6 is a top view thereof; and,
FIG. 7 is a bottom view thereof.
The broken lines depict portions of the ratchet wrench handle in which the design is embodied that are not considered part of the claimed design.

1 Claim, 7 Drawing Sheets

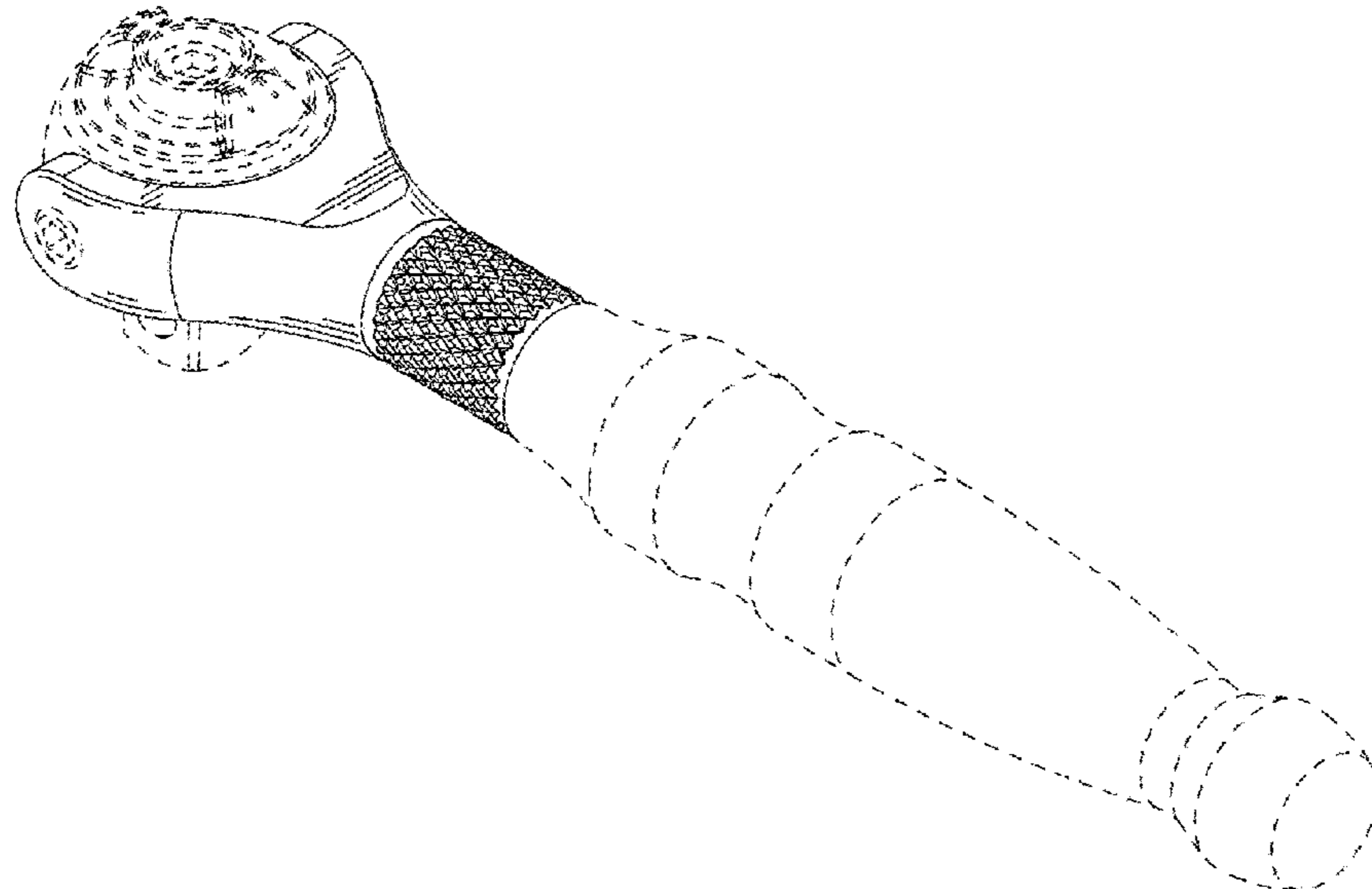

(56)

References Cited

U.S. PATENT DOCUMENTS

2011/0303052	A1*	12/2011	Chen	B25B 13/06 81/57.5
2012/0260775	A1*	10/2012	Lance	B25B 13/04 81/57.5
2013/0305887	A1*	11/2013	Lai	B25B 13/04 81/177.8

* cited by examiner

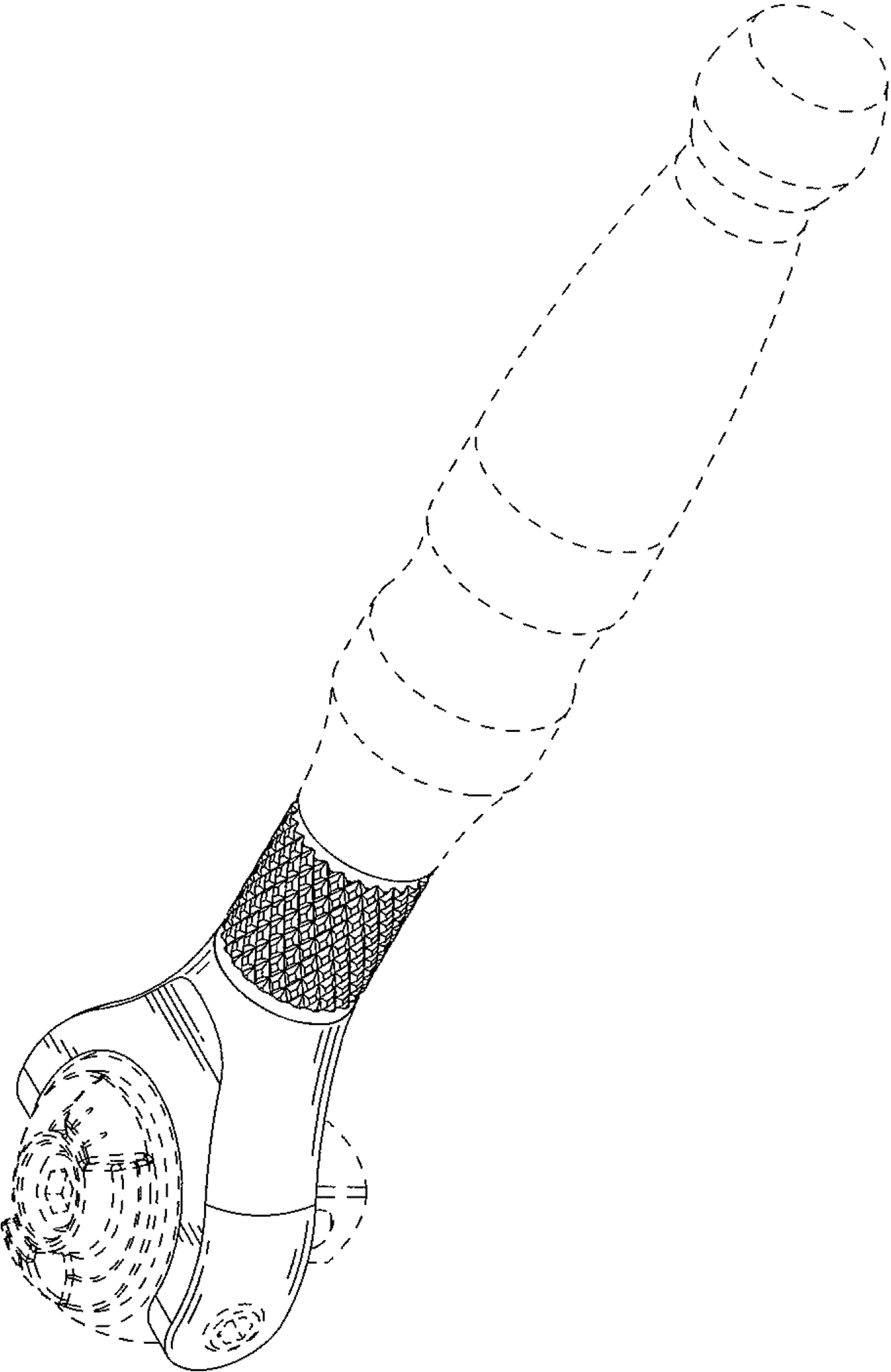

FIG. 1

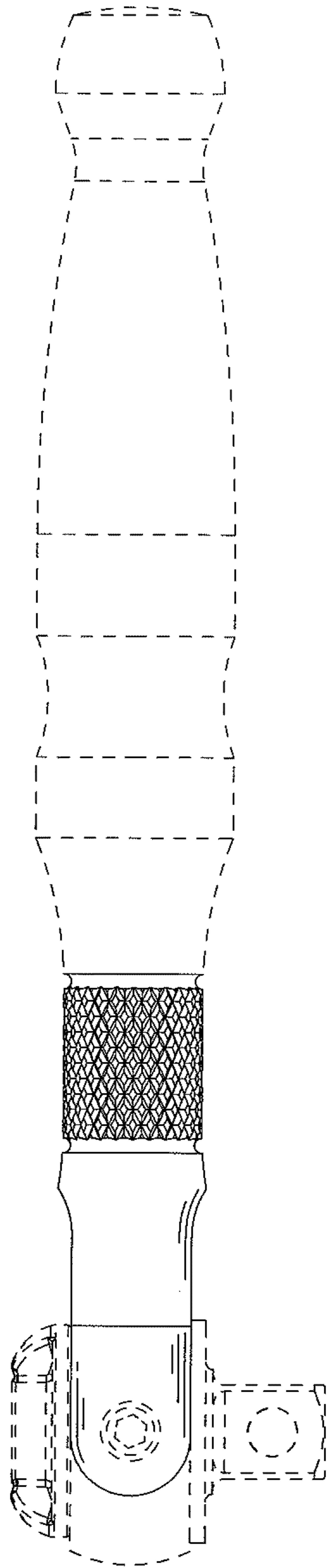

FIG. 2

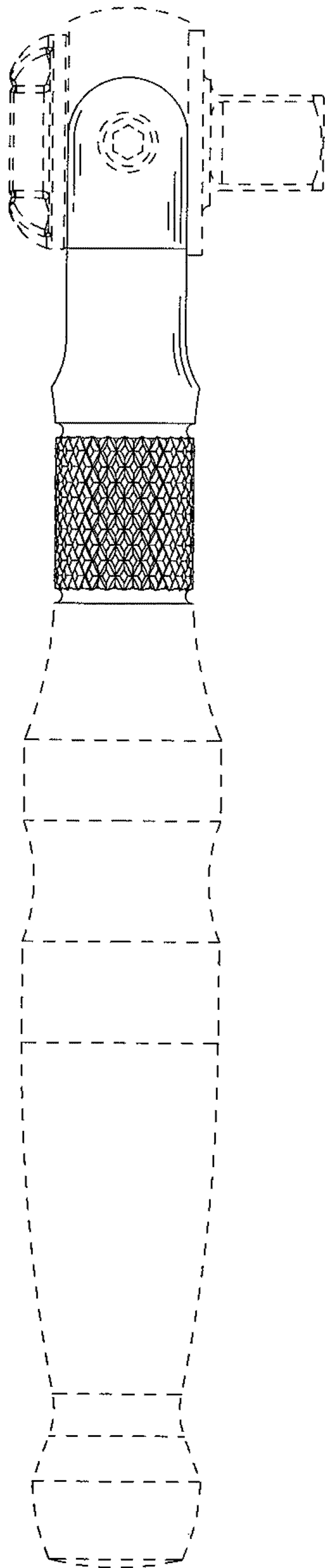

FIG. 3

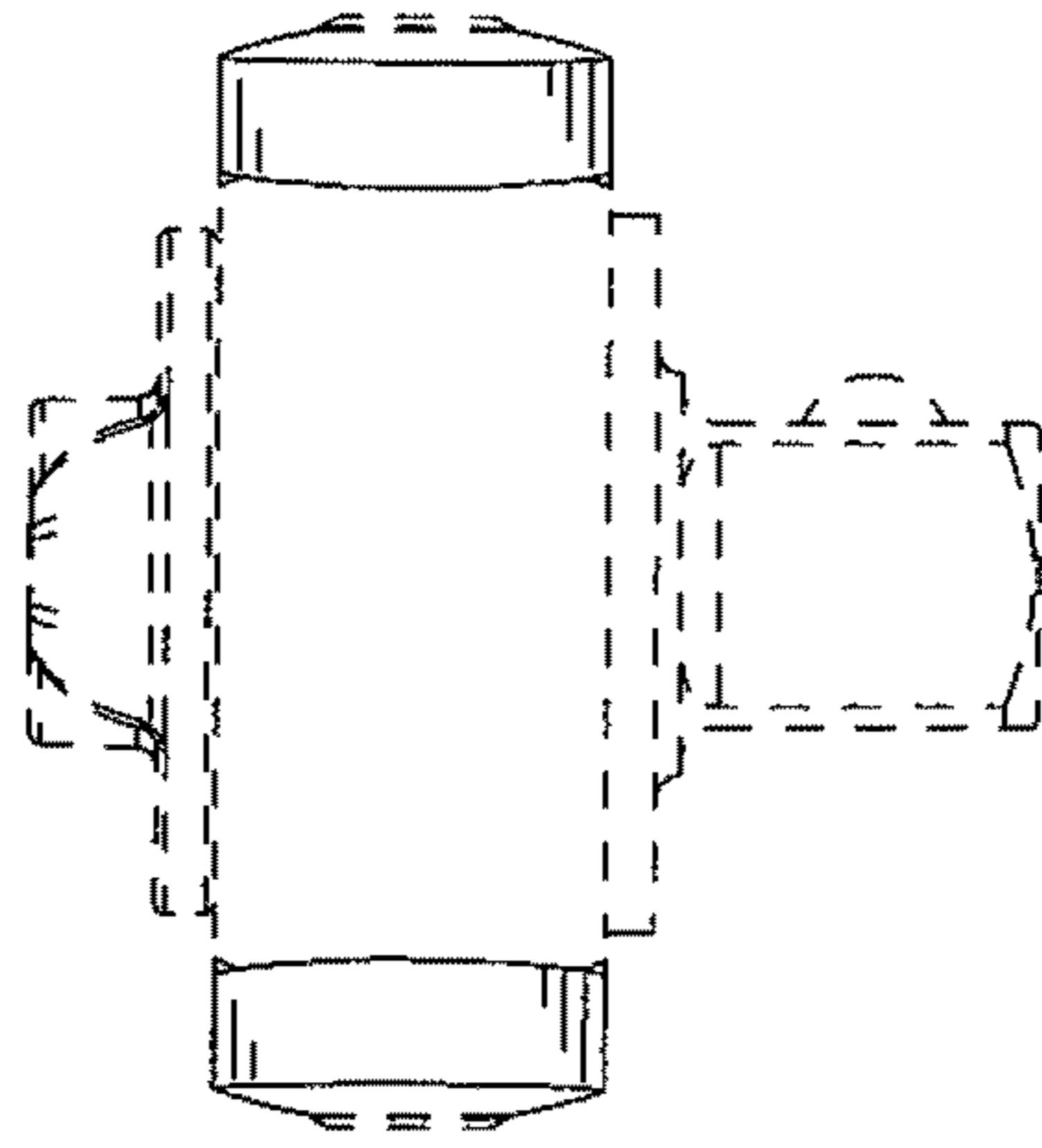

FIG. 4

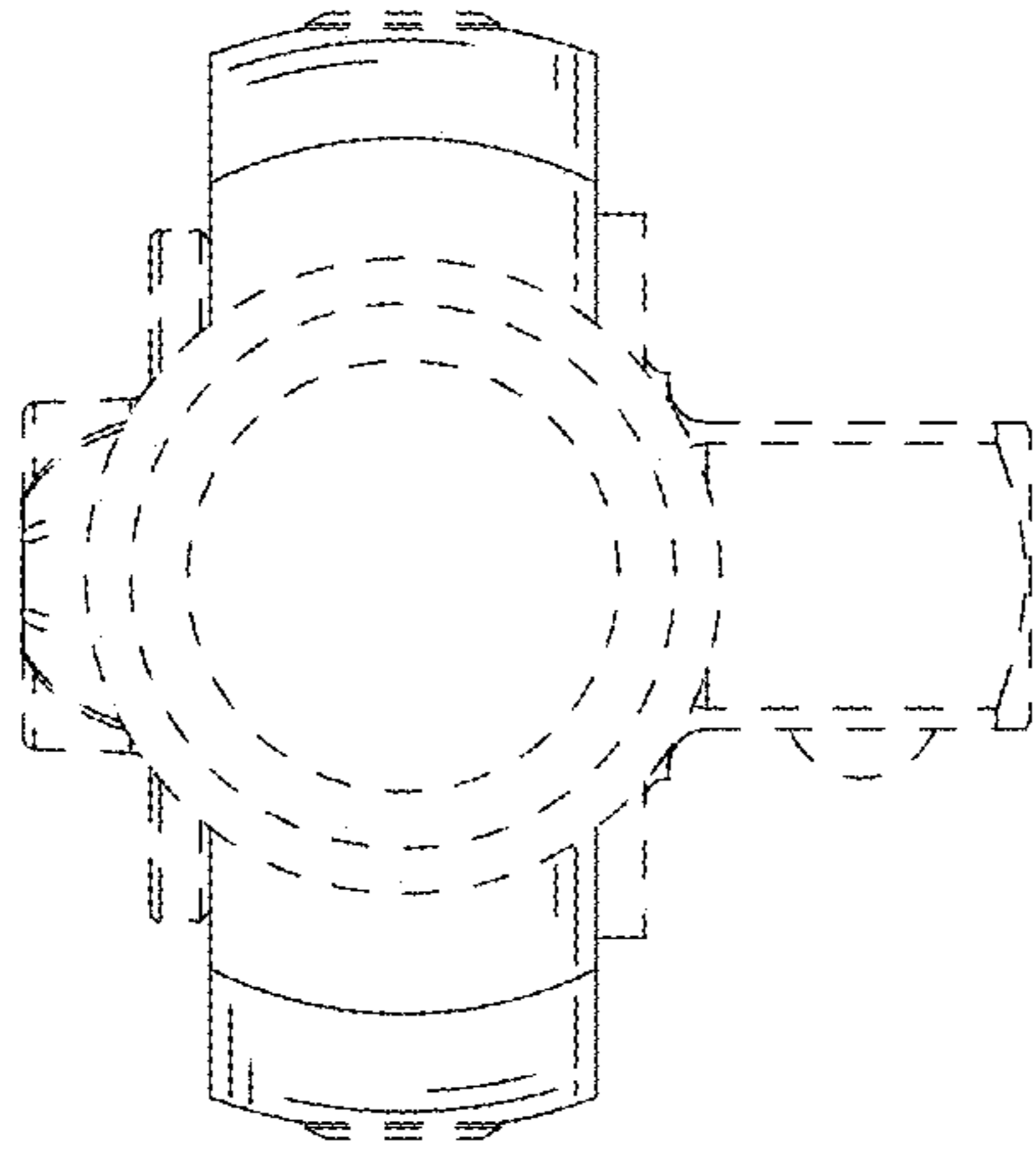

FIG. 5

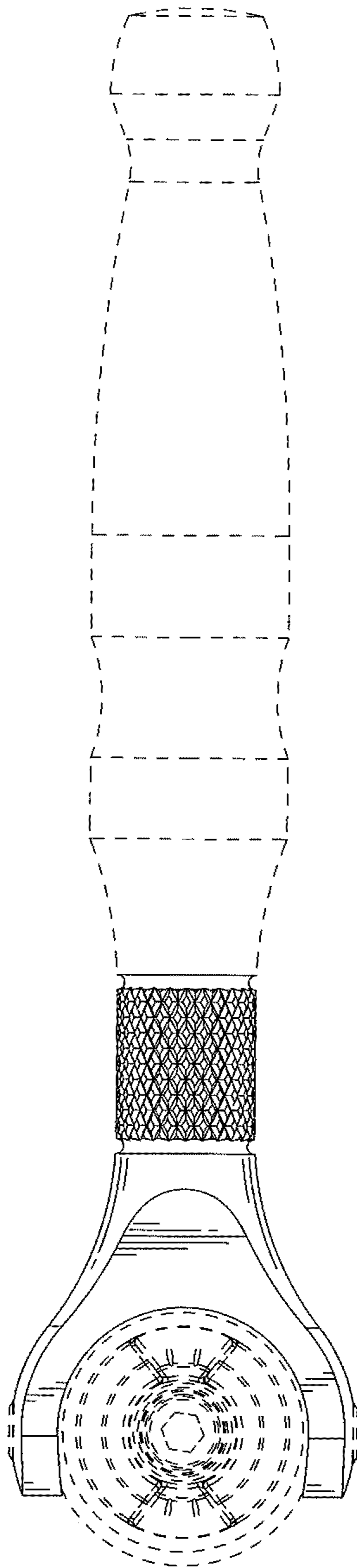

FIG. 6

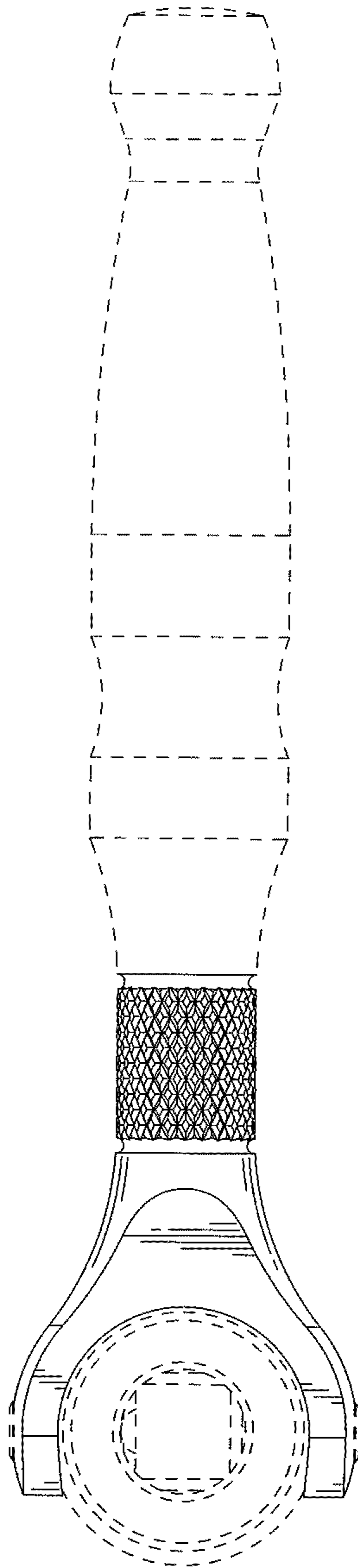

FIG. 7