



US00D893172S

(12) **United States Design Patent**
Kennard

(10) **Patent No.:** **US D893,172 S**

(45) **Date of Patent:** **** Aug. 18, 2020**

(54) **FLAG FOOTBALL BELT/WAISTBAND CLIP**

D670,903 S * 11/2012 Ormsbee D3/215
D805,295 S * 12/2017 Paterson D3/215
D851,917 S * 6/2019 Paterson D3/215

(71) Applicant: **Shaun M. Kennard**, Encinitas, CA
(US)

* cited by examiner

(72) Inventor: **Shaun M. Kennard**, Encinitas, CA
(US)

Primary Examiner — Catherine R Oliver-Garcia

(74) *Attorney, Agent, or Firm* — Richard D. Clarke

(**) Term: **15 Years**

(21) Appl. No.: **29/682,826**

(57) **CLAIM**

I claim the ornamental design for a flag football belt/waistband clip, as shown and described.

(22) Filed: **Mar. 8, 2019**

(51) **LOC (12) Cl.** **03-01**

(52) **U.S. Cl.**

USPC **D3/221**

(58) **Field of Classification Search**

USPC D3/207–212, 221, 215; D8/371, 394,
D8/395, 396; 24/3.6, 3.11, 3.12, 3.13,
24/570, 599.6; 224/666, 268–269, 247,
224/236, 240, 242, 197, 165, 255, 674,
224/677, 904; 248/227.1, 49, 300–301,
248/316.7, 51, 489

CPC A45F 5/00; A45F 5/02; A45F 5/021; A45F
5/06

See application file for complete search history.

DESCRIPTION

FIG. 1 is a front and left side per perspective view of the flag football belt/waistband clip shown in place on a belt and having a flag attached thereto;

FIG. 2 is a top left side and perspective view of the flag football belt/waistband clip;

FIG. 3 is a right side elevation view of the flag football belt/waistband clip;

FIG. 4 is a left side elevation view of the flag football belt/waistband clip;

FIG. 5 is a front view of the flag football belt/waistband clip;

FIG. 6 is a bottom view of the flag football belt/waistband clip;

FIG. 7 is a top plan view of the flag football belt/waistband clip; and,

FIG. 8 is a rear view of the flag football belt/waistband clip. The broken lines in FIG. 1 of the drawings show unclaimed environment only and form no part of the claimed design.

(56) **References Cited**

U.S. PATENT DOCUMENTS

D33,452 S * 10/1900 Pax D19/65
D280,973 S * 10/1985 Ferrell D8/395
D349,810 S * 8/1994 Rutledge D3/215
D382,105 S * 8/1997 Bonaldi D11/201
D453,294 S * 2/2002 Bitzer D8/395

1 Claim, 4 Drawing Sheets

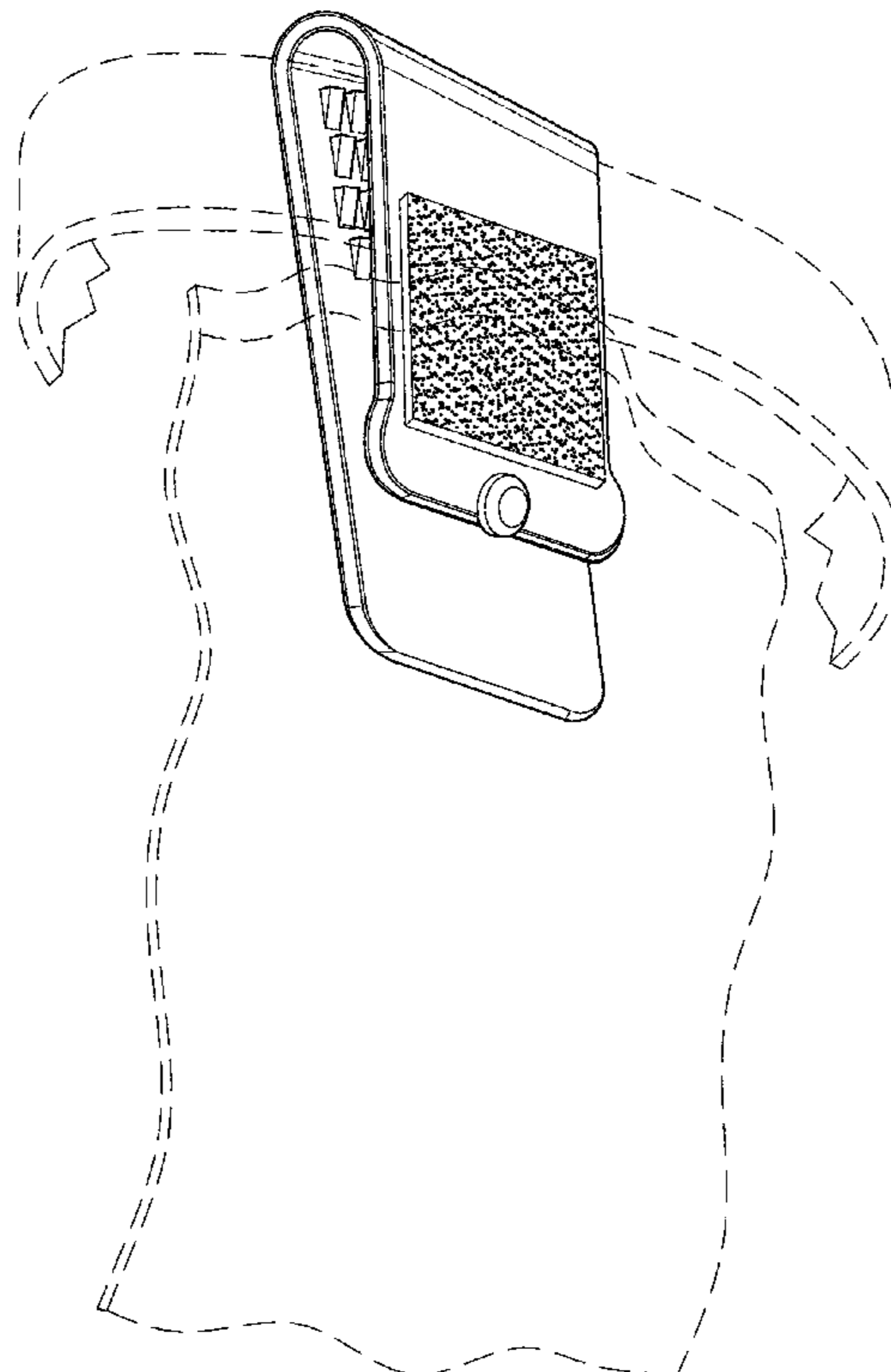

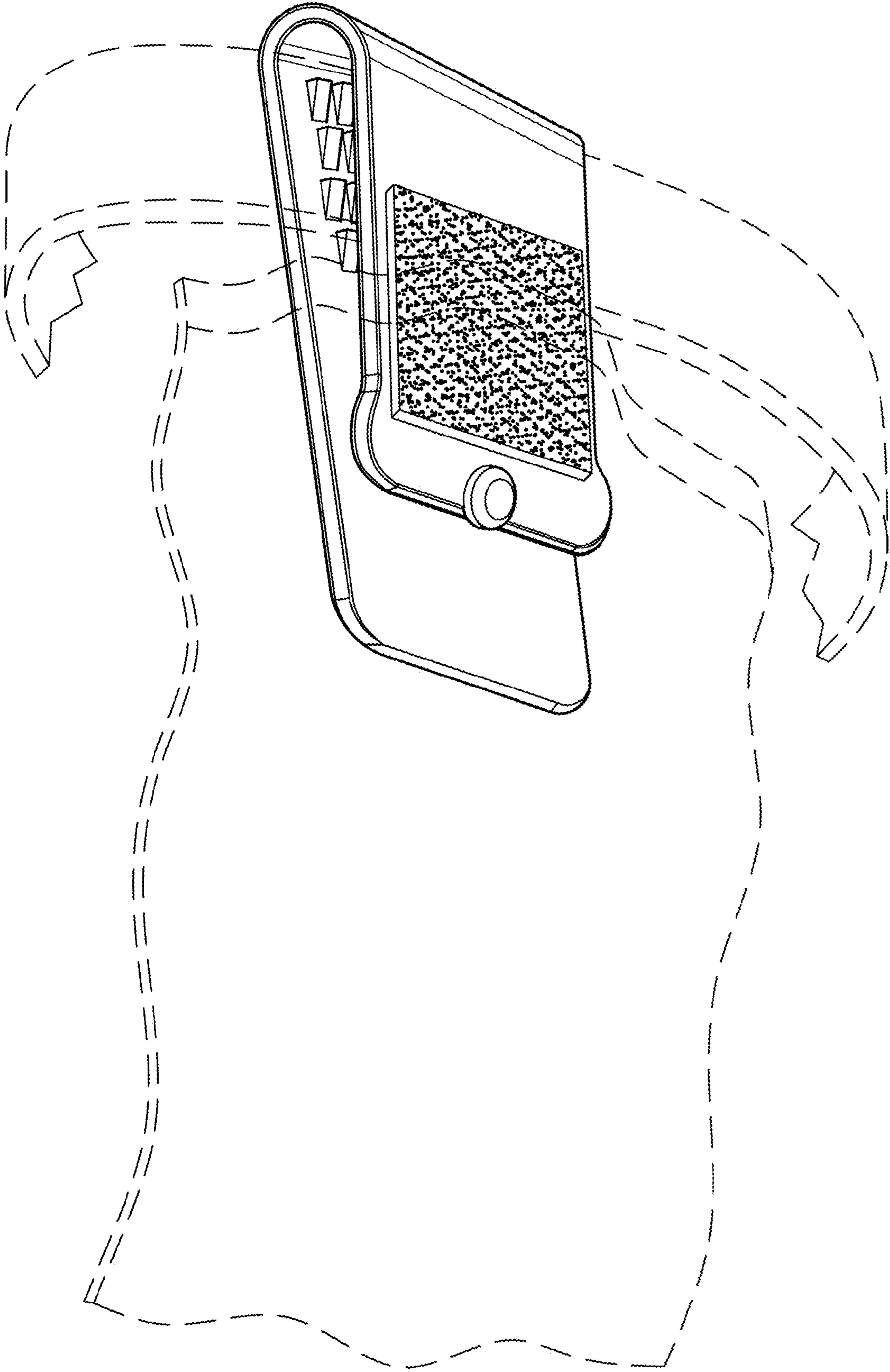

FIG. 1

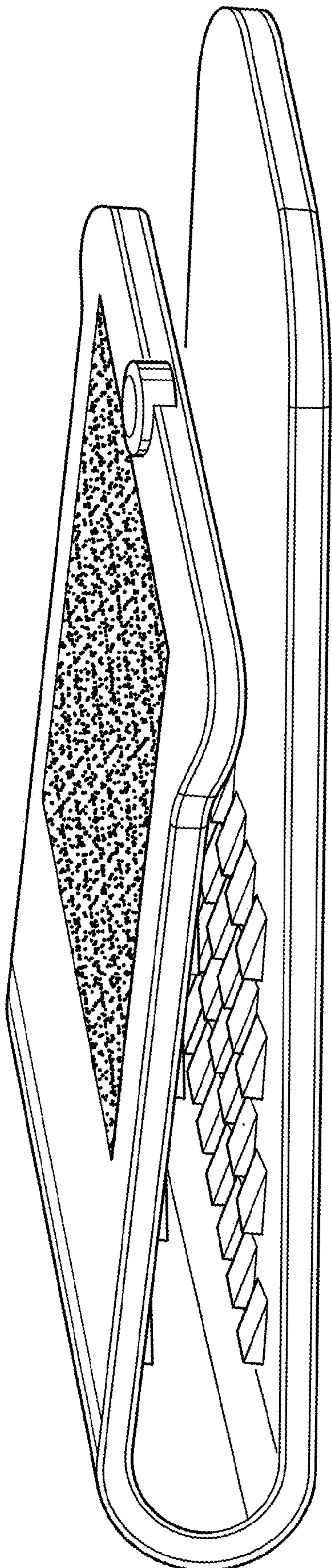

FIG. 2

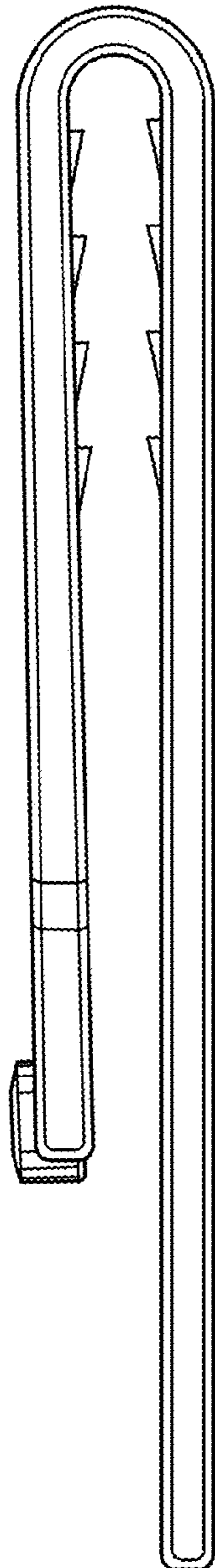

FIG. 3

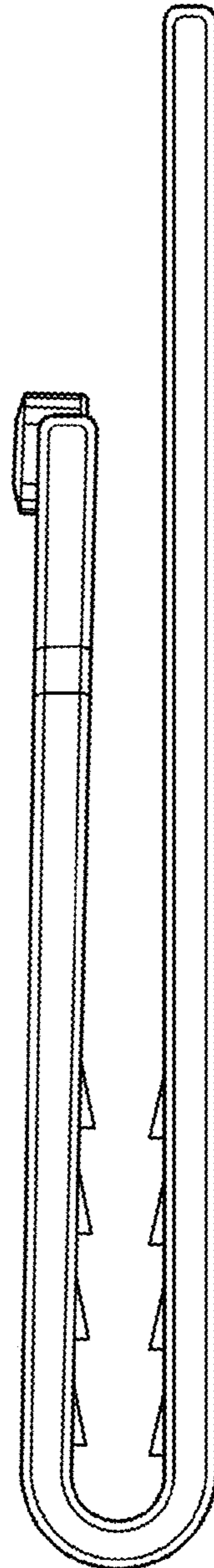

FIG. 4

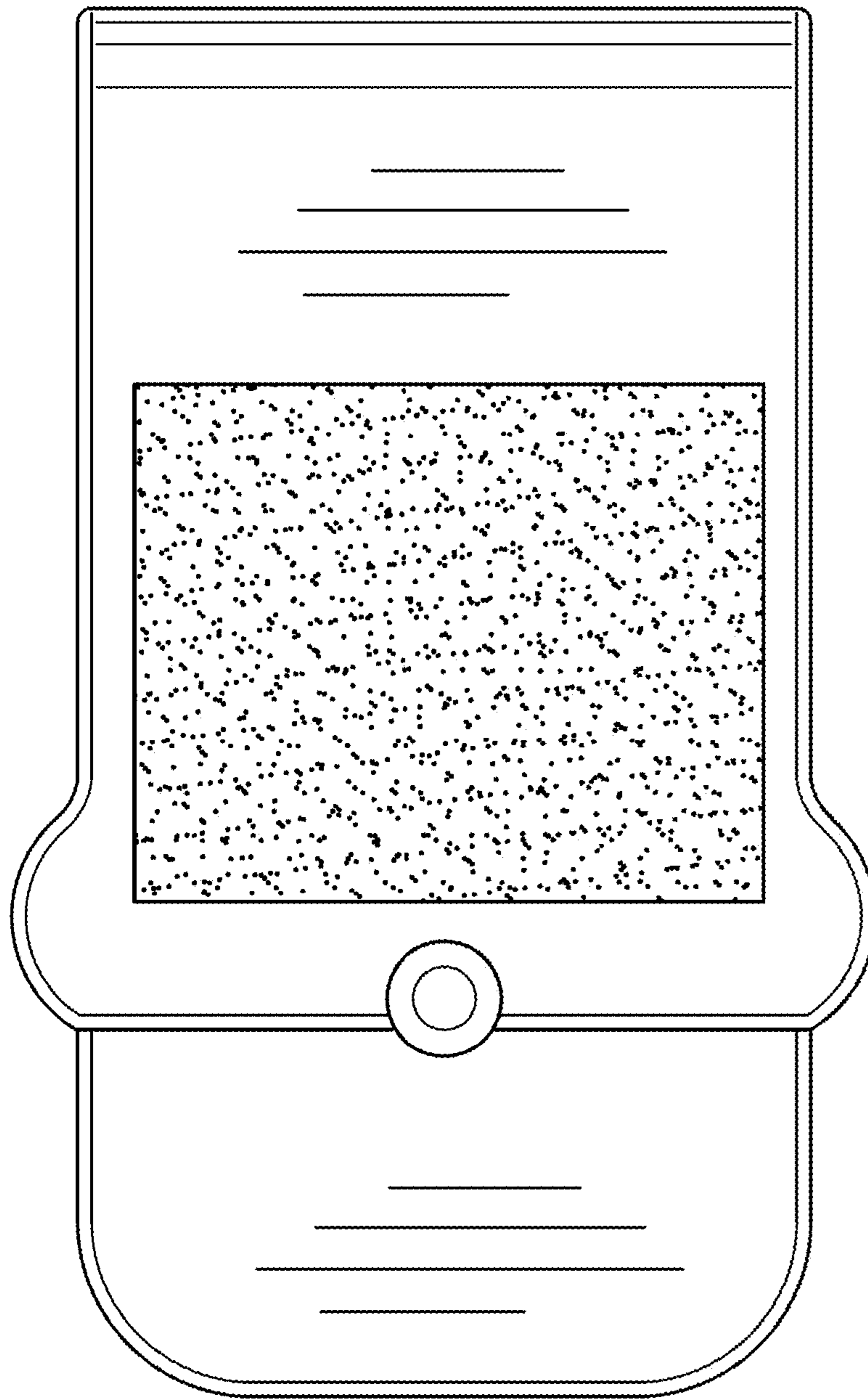

FIG. 5

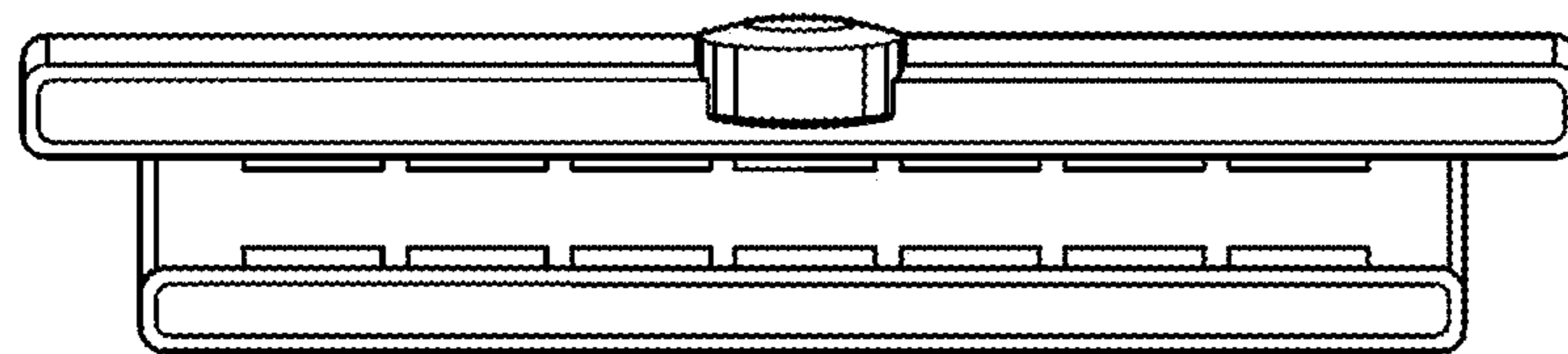

FIG. 6

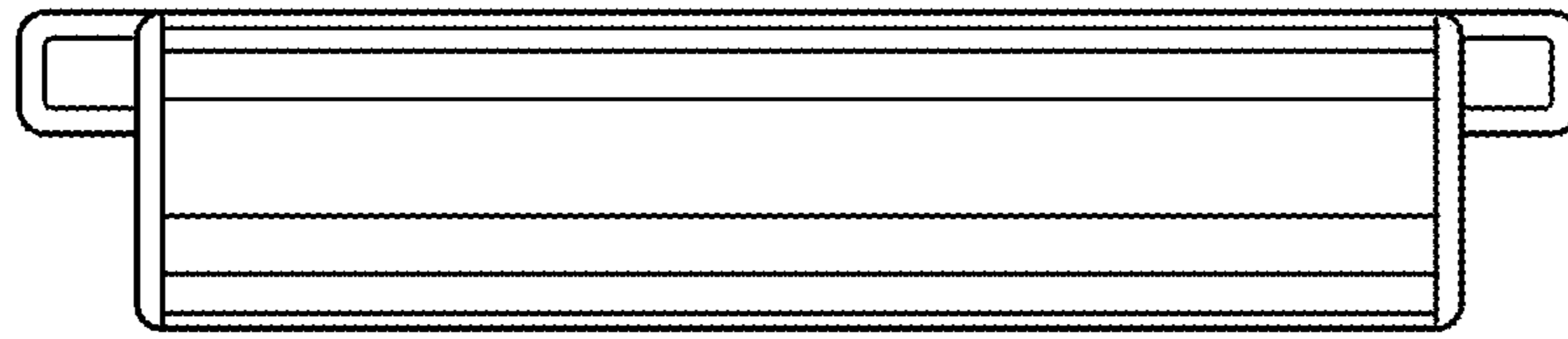

FIG. 7

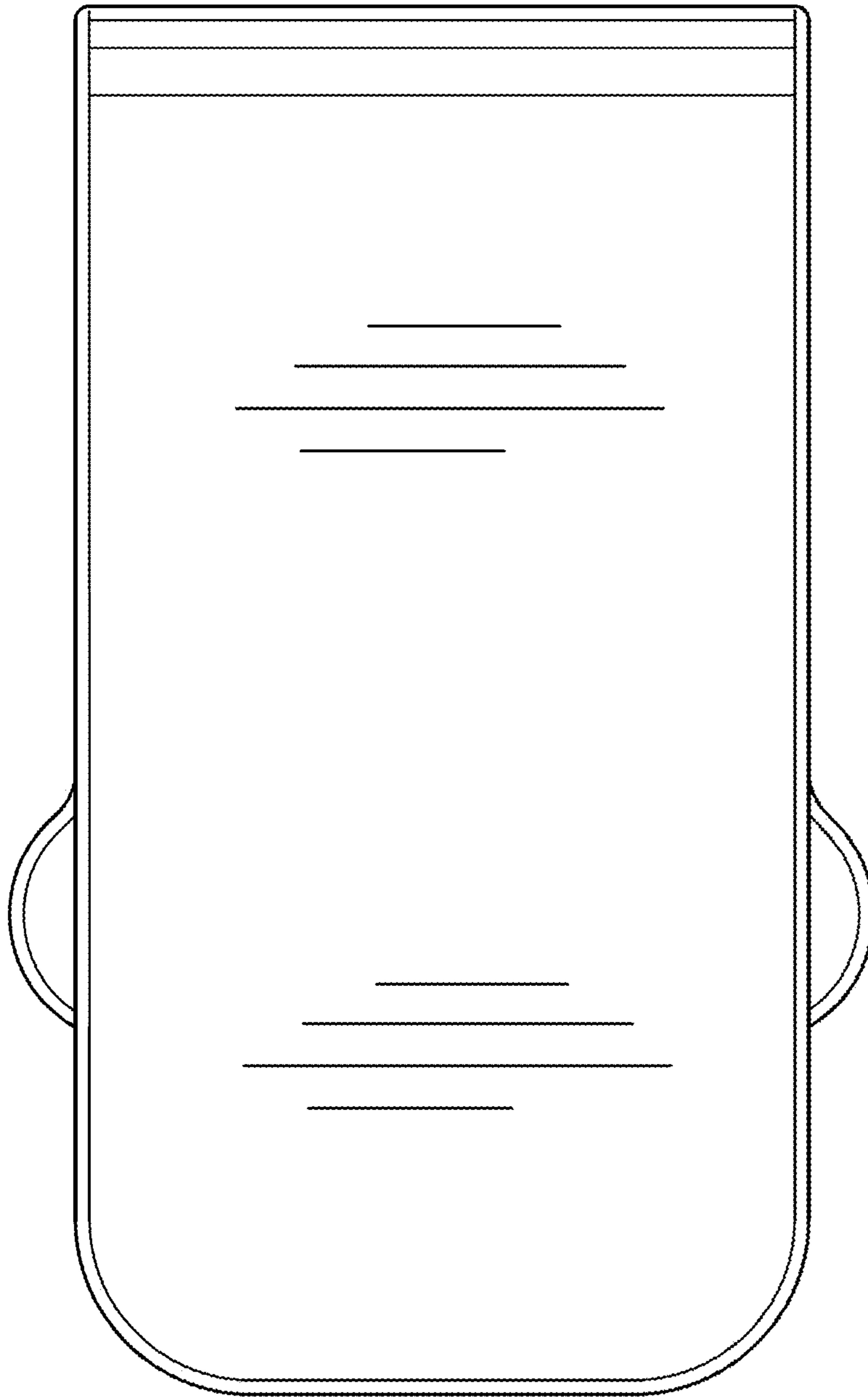

FIG. 8