



US00D893095S

(12) **United States Design Patent** (10) **Patent No.:** **US D893,095 S**
Ziering et al. (45) **Date of Patent:** **** Aug. 11, 2020**

(54) **CASE FOR CIGARETTE PRODUCTS**

(71) Applicant: **PAQ, LTD.**, Denver, CO (US)

(72) Inventors: **Cody Ziering**, Carbondale, CO (US);
Brett Gelfand, Carbondale, CO (US);
Mark Rottenberg, Reisterstown, MD (US)

(73) Assignee: **PAQ Holdings, LLC**, Boca Raton, FL (US)

(**) Term: **15 Years**

(21) Appl. No.: **29/672,218**

(22) Filed: **Dec. 4, 2018**

(51) **LOC (12) Cl.** **27-06**

(52) **U.S. Cl.**
USPC **D27/189**

(58) **Field of Classification Search**
USPC D27/189, 172, 183, 186, 187; 131/329,
131/257, 260
CPC A24F 15/20; A24F 15/02; A24F 15/00;
A24F 15/005
See application file for complete search history.

(56) **References Cited**

U.S. PATENT DOCUMENTS

| | | | | | |
|--------------|------|---------|-------------|-------|-----------------------|
| 2,112,801 | A * | 3/1938 | Zint | | A24F 15/20 206/253 |
| D142,511 | S * | 10/1945 | Beveridge | | D27/189 |
| D572,057 | S * | 7/2008 | Lledo | | D6/515 |
| D591,898 | S * | 5/2009 | McKenzie | | D27/187 |
| D665,273 | S * | 8/2012 | Castelletti | | D9/758 |
| D693,054 | S * | 11/2013 | Verleur | | D27/189 |
| D807,579 | S * | 1/2018 | Wu | | D27/189 |
| 10,238,142 | B1 * | 3/2019 | Haddad | | G06Q 10/00 |
| 2010/0059395 | A1 * | 3/2010 | England | | B65D 5/42 206/259 |

(Continued)

Primary Examiner — Marissa J Cash
Assistant Examiner — Rebecca Tsehaye
(74) *Attorney, Agent, or Firm* — Bednarek Legal, PLLC

(57) **CLAIM**

The ornamental design for a case for cigarette products, as shown and described.

DESCRIPTION

FIG. 1 is a front perspective view of a case for cigarette products in the open position,
FIG. 2 is a front elevational view of the case in the open position;
FIG. 3 is a rear elevational view of the case in the open position;
FIG. 4 is a left side elevational view of the case in the open position;
FIG. 5 is a right side elevational view of the case in the open position;
FIG. 6 is a top plan view of the case in the open position;
FIG. 7 is a bottom plan view of the case in the open position;
FIG. 8 is a front perspective view of a case for tobacco products in the closed position,
FIG. 9 is a front elevational view of the case in the closed position;
FIG. 10 is a rear elevational view of the case in the closed position;
FIG. 11 is a left side elevational view of the case in the closed position;
FIG. 12 is a right side elevational view of the case in the closed position;
FIG. 13 is a top plan view of the case in the closed position;
and,
FIG. 14 is a bottom plan view of the case in the closed position.
The broken lines in the drawings illustrate portions of the case for cigarette products that form no part of the claimed design.

1 Claim, 14 Drawing Sheets

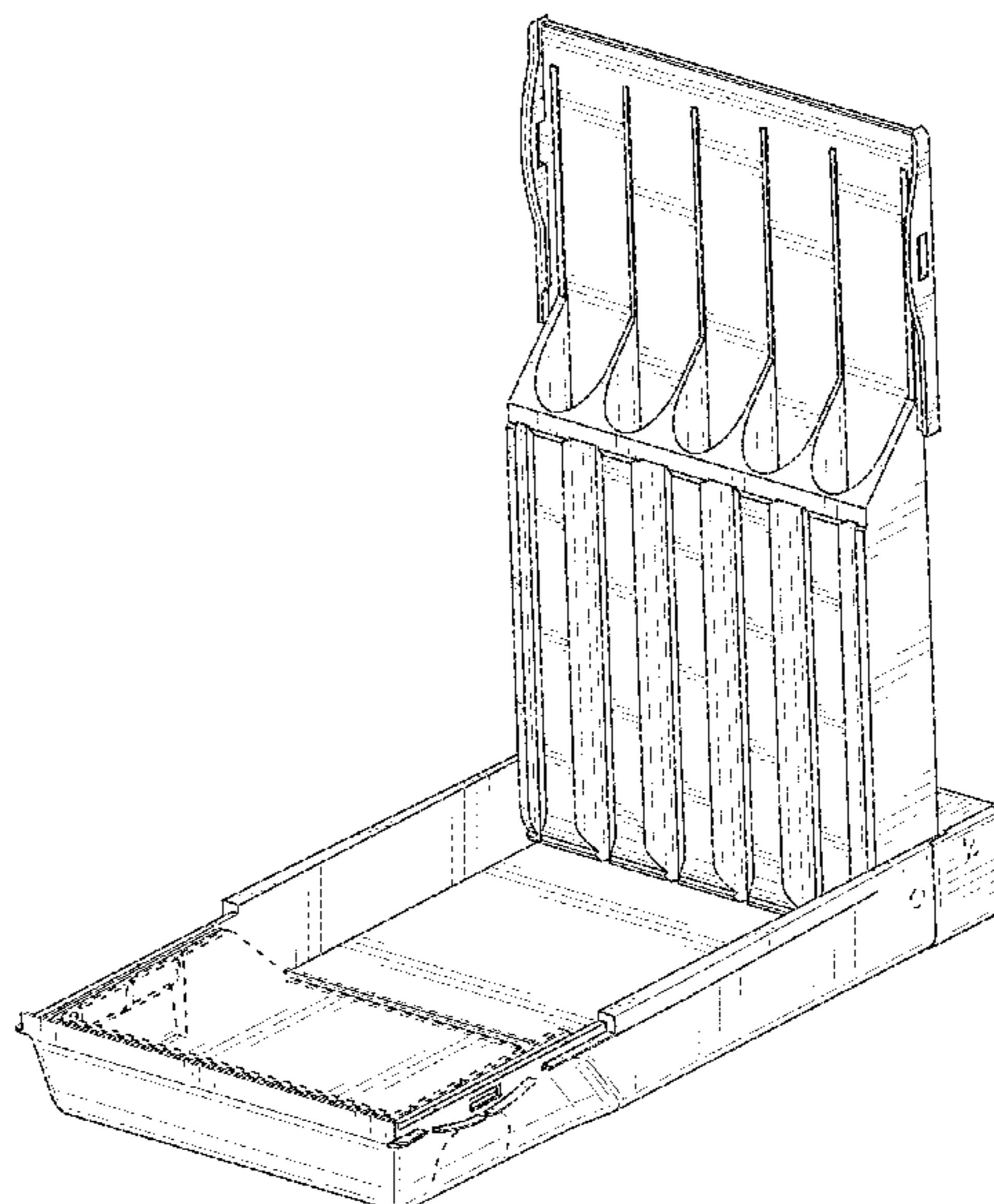

(56)

References Cited

U.S. PATENT DOCUMENTS

2015/0272212 A1* 10/2015 Fabregas Pedrell .. A24F 15/005
700/236
2016/0090230 A1* 3/2016 Dong B65D 85/1045
206/246
2016/0130074 A1* 5/2016 Kastha B65D 5/6688
206/245
2017/0001790 A1* 1/2017 Kahawaiolaa B65D 85/1045

* cited by examiner

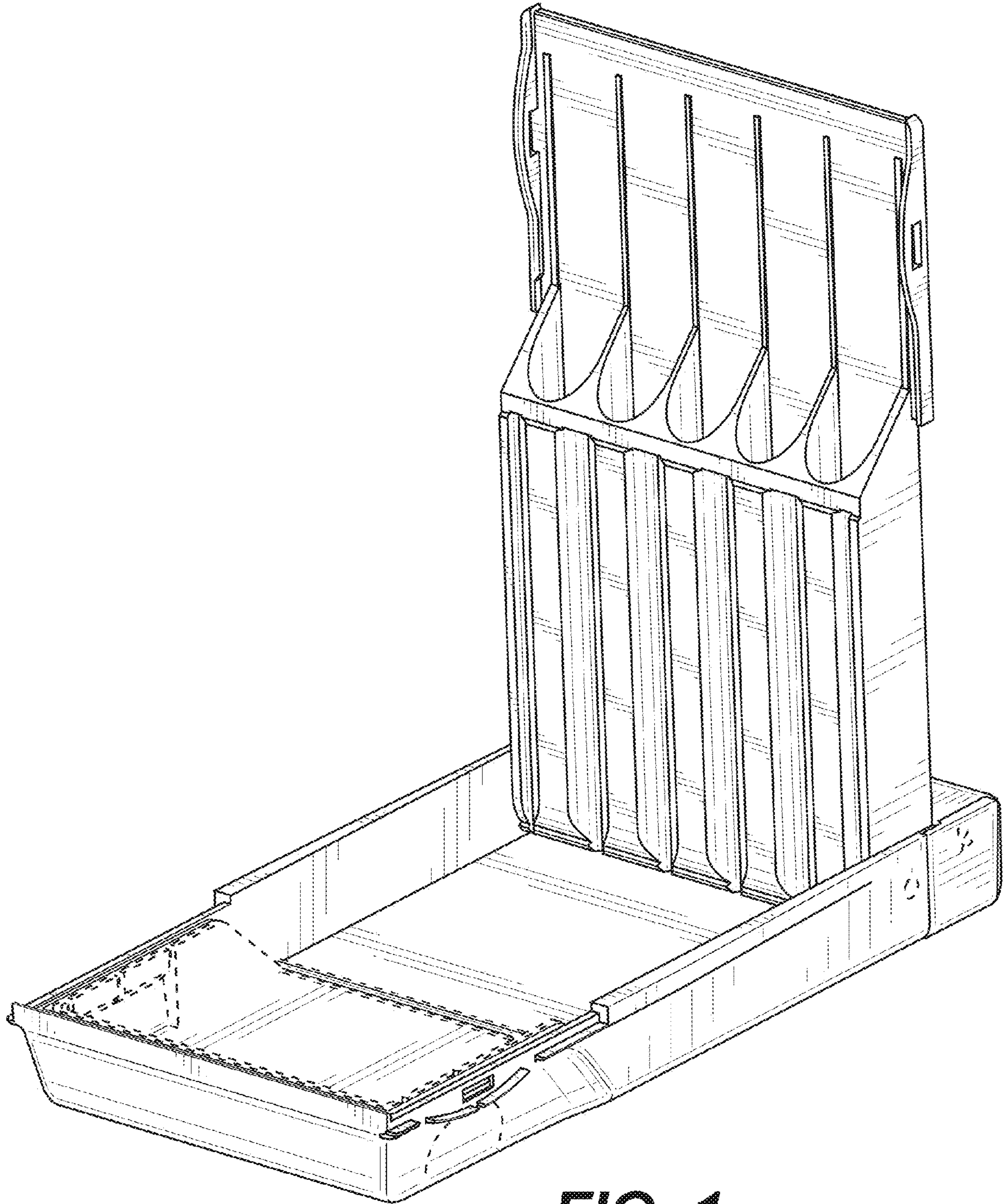

FIG. 1

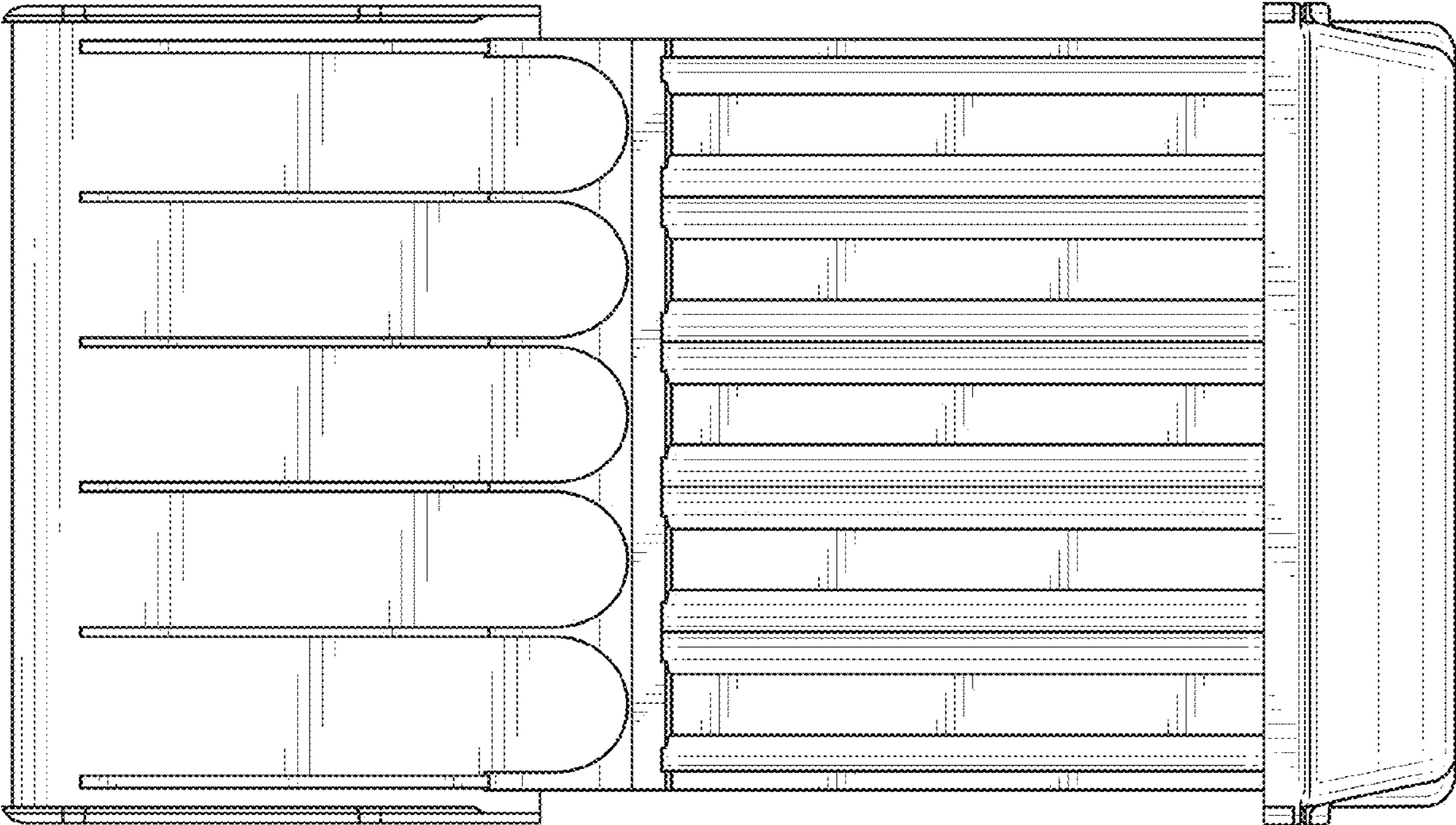

FIG. 2

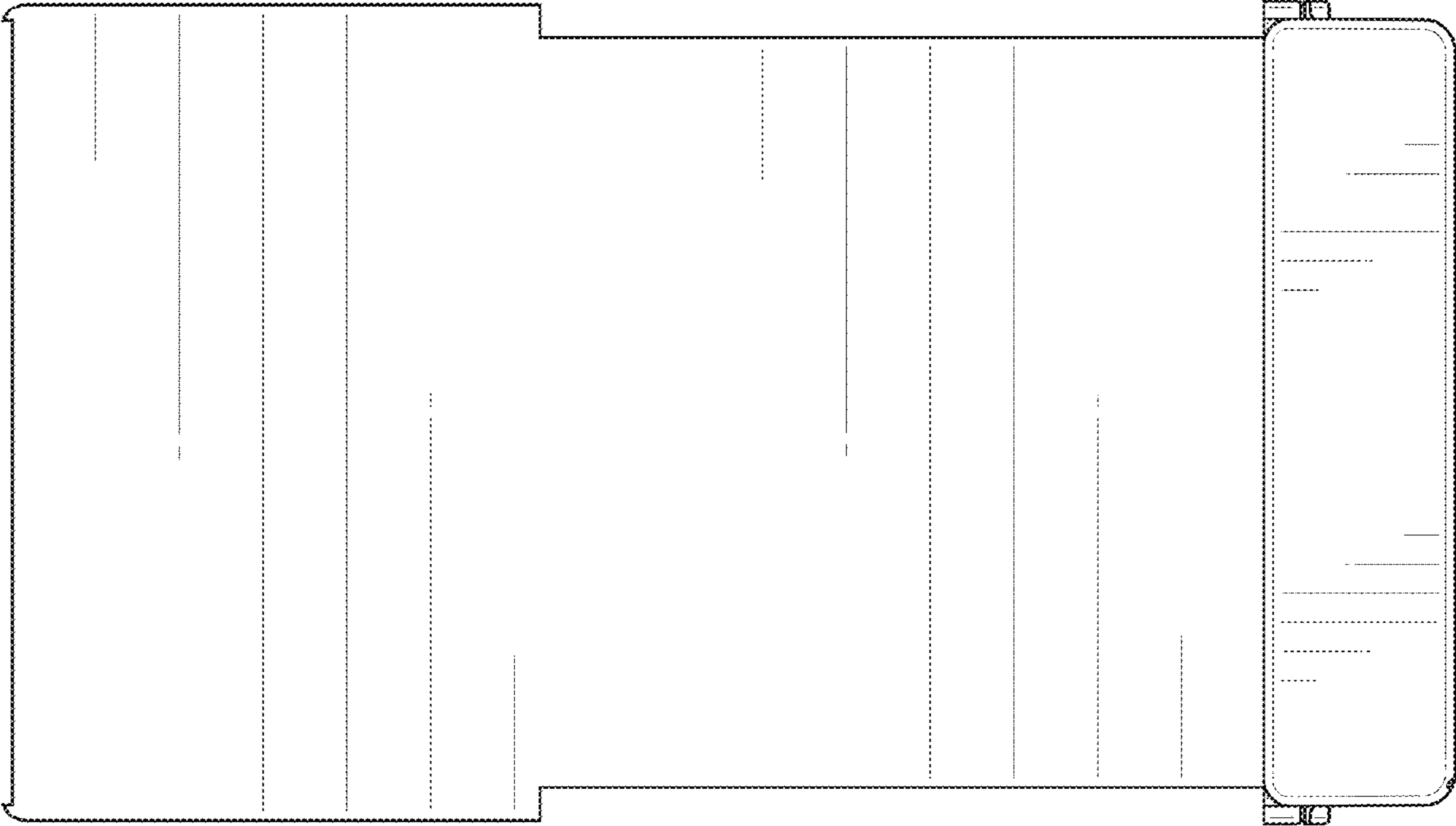

FIG. 3

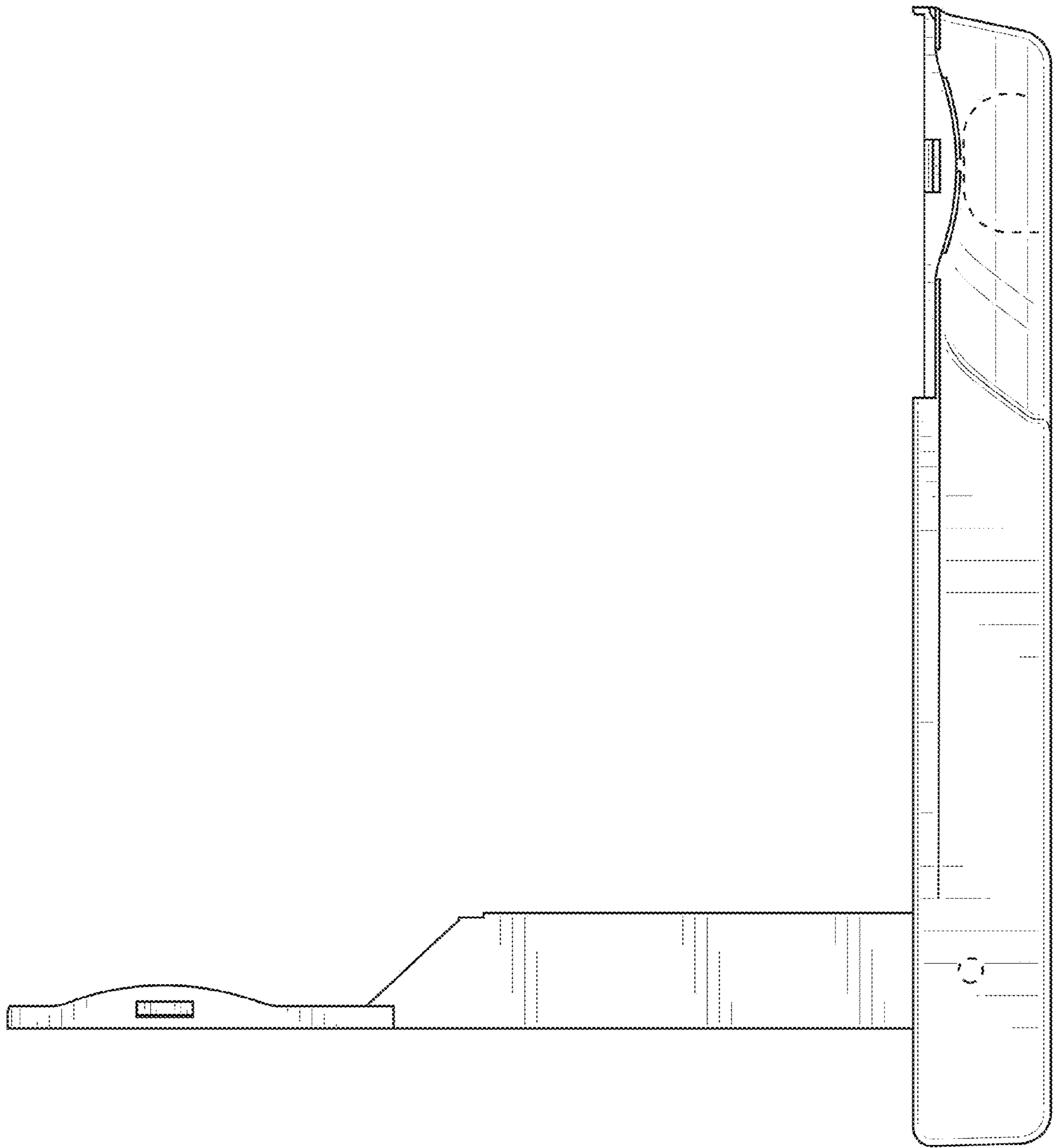

FIG. 4

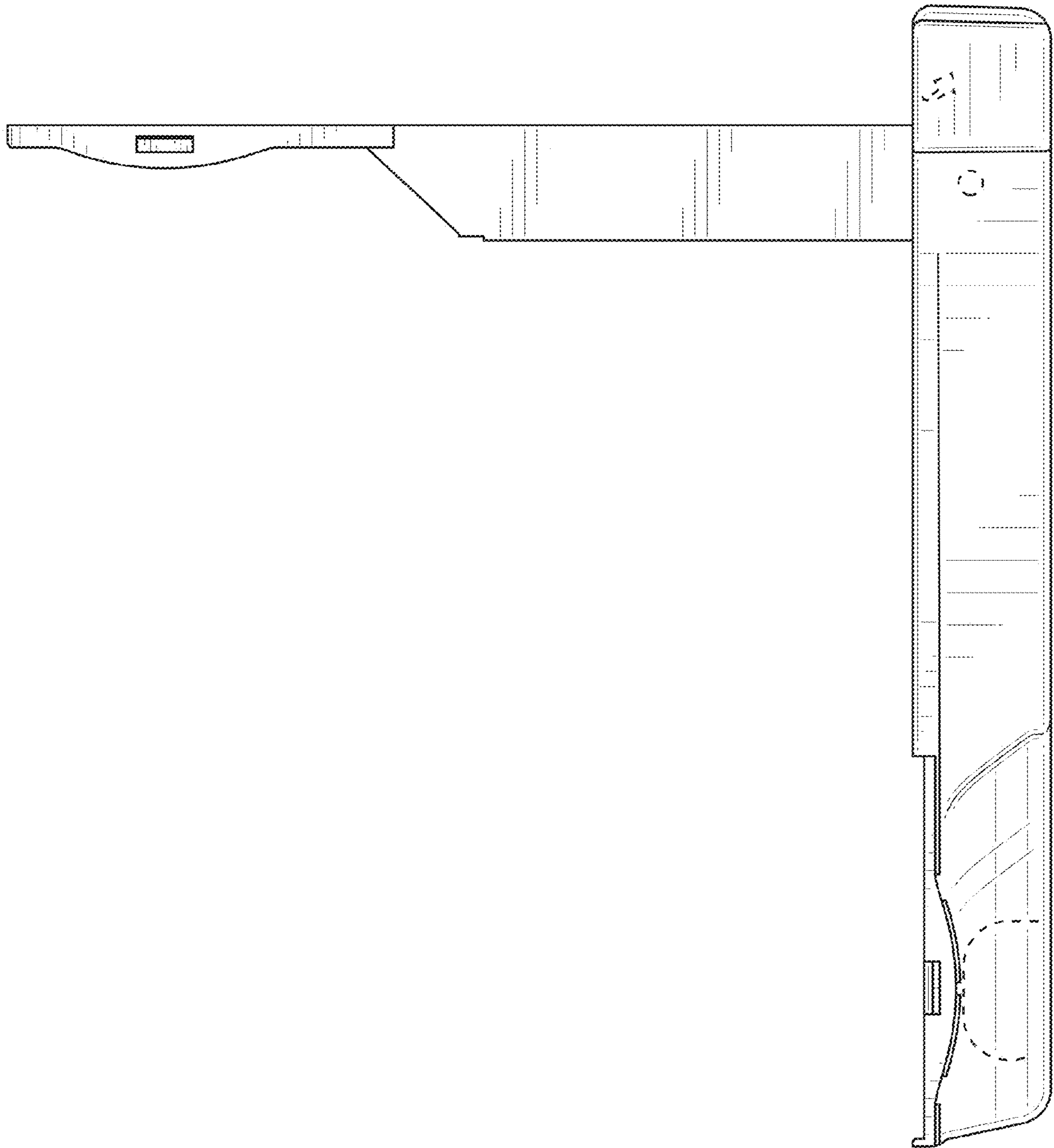

FIG. 5

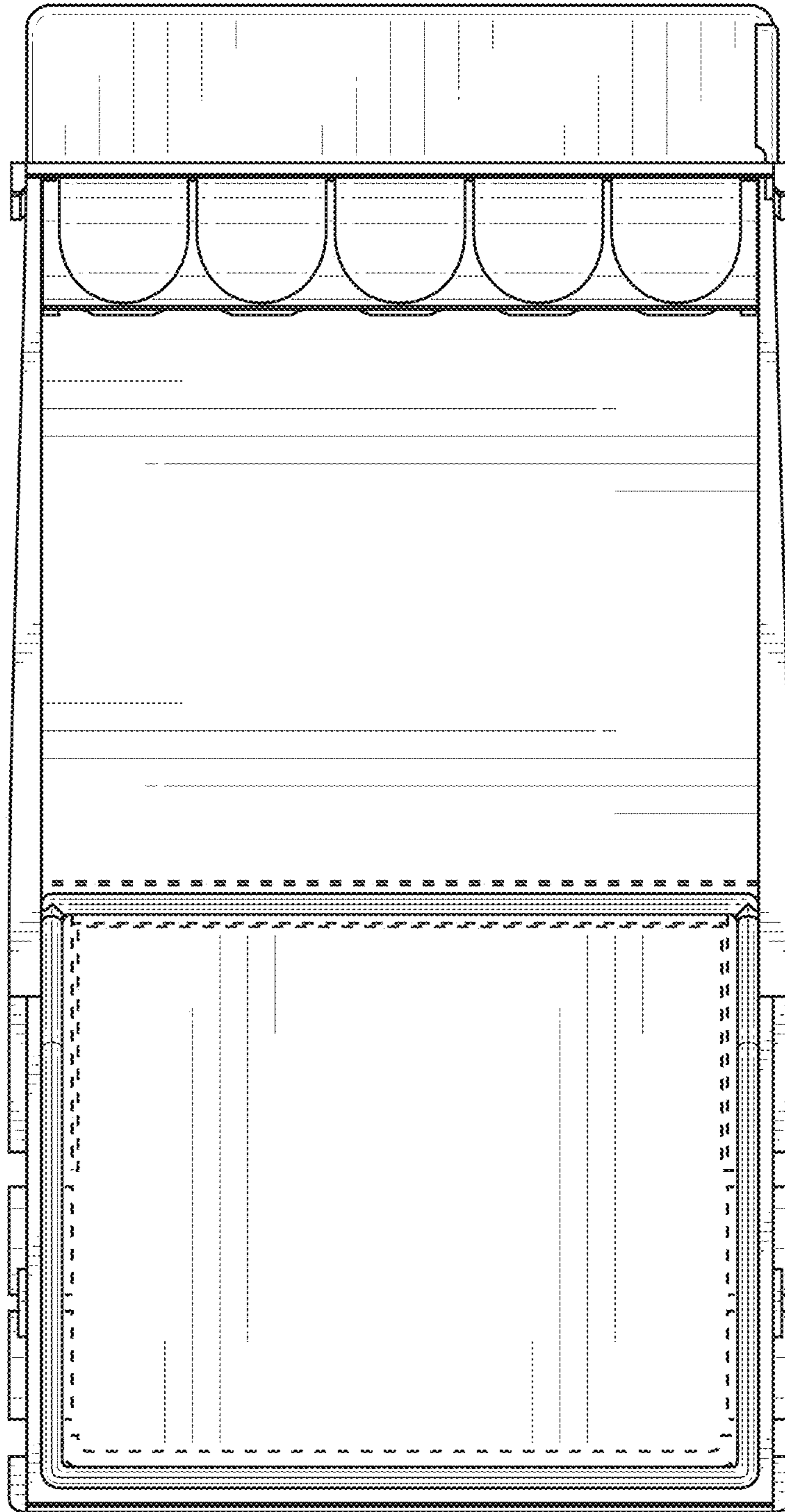

FIG. 6

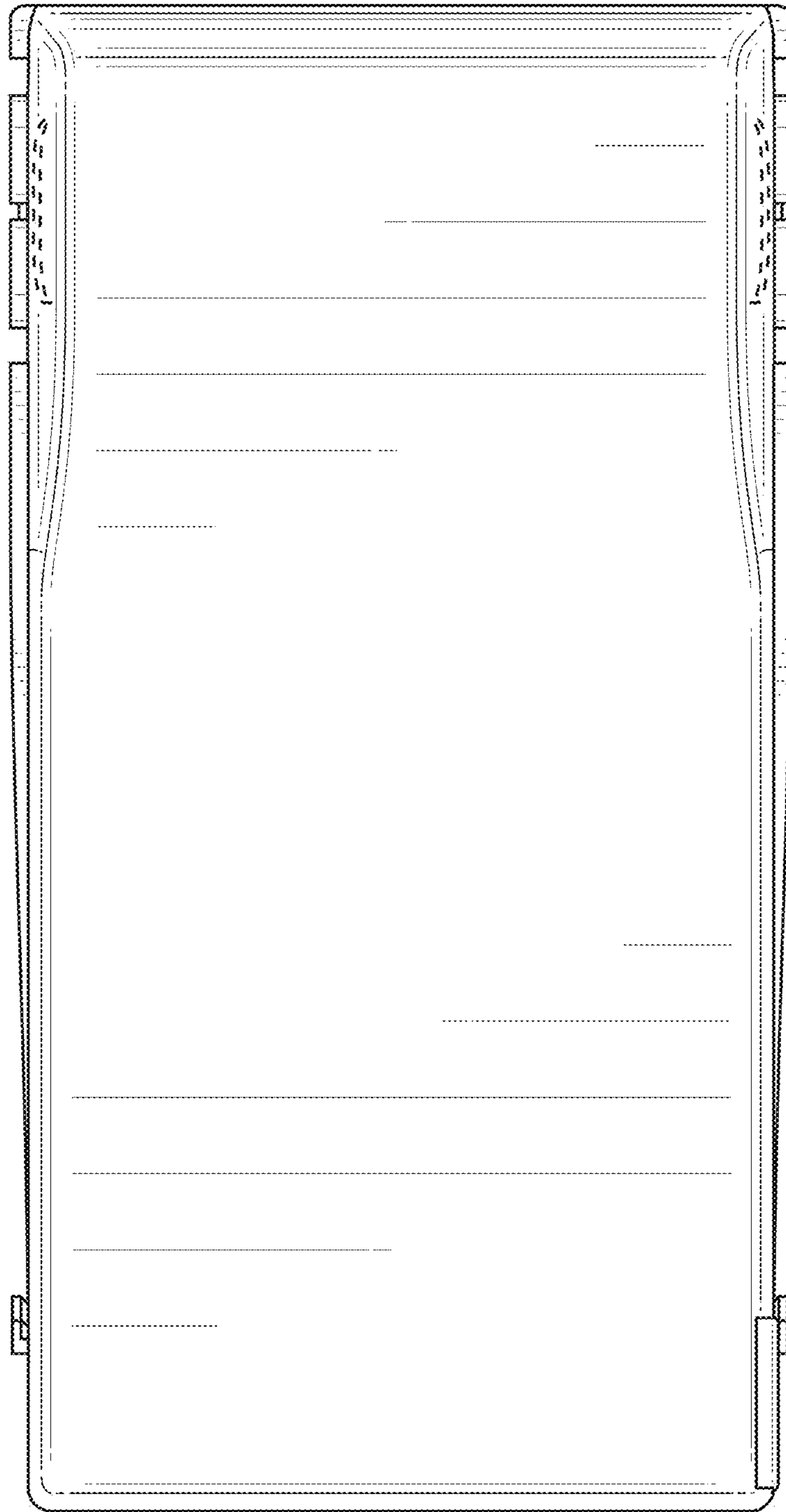

FIG. 7

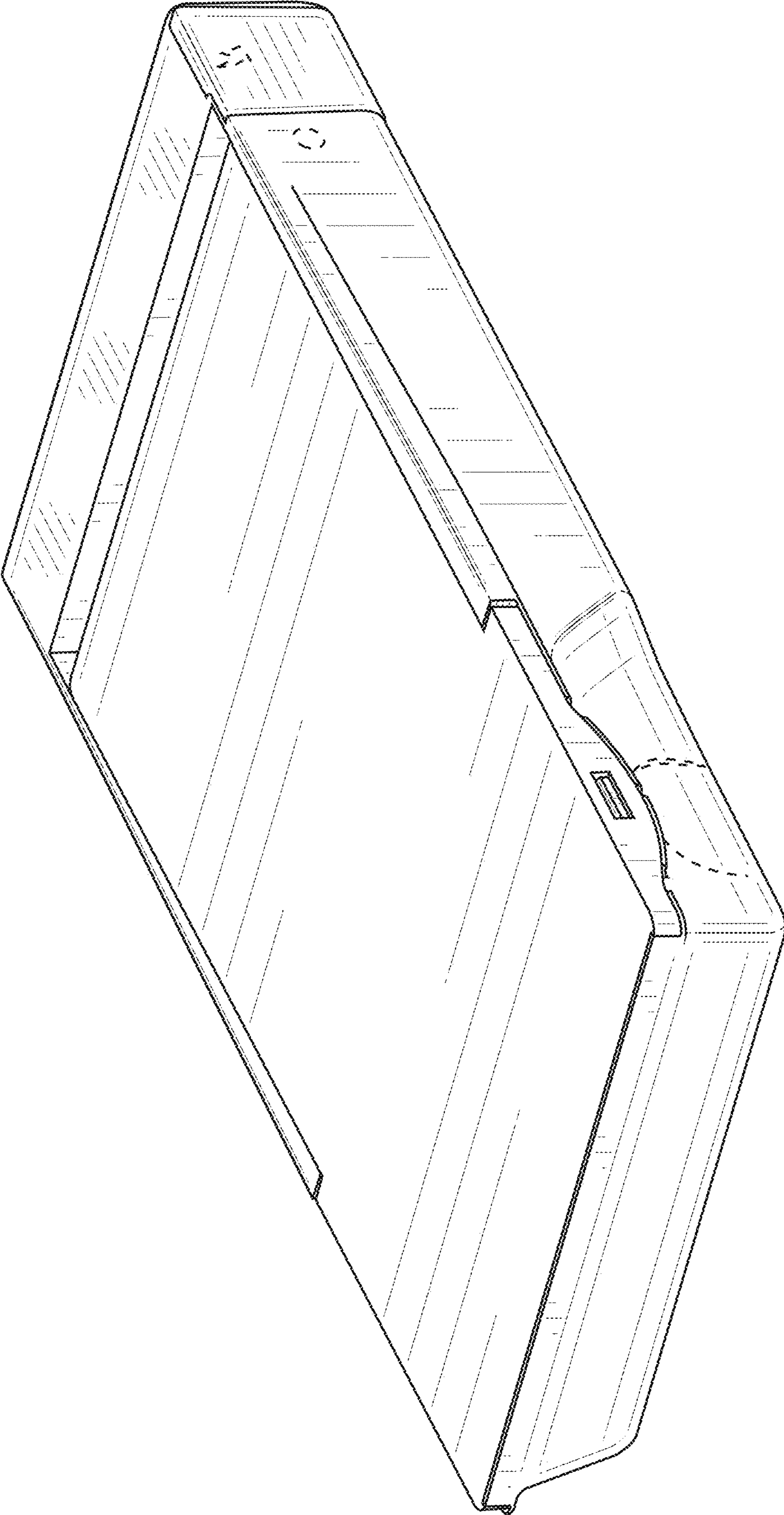

FIG. 8

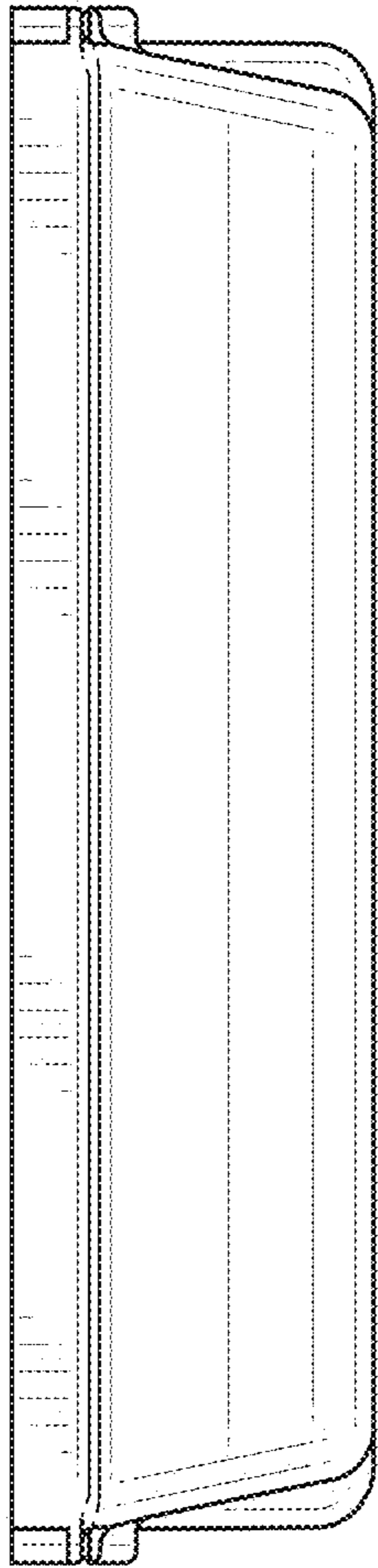

FIG. 9

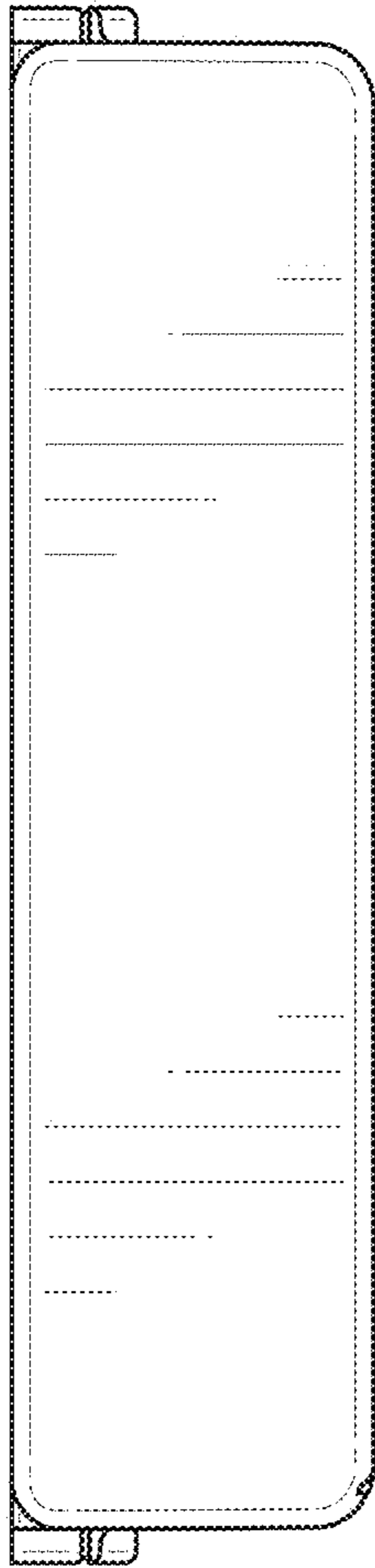

FIG. 10

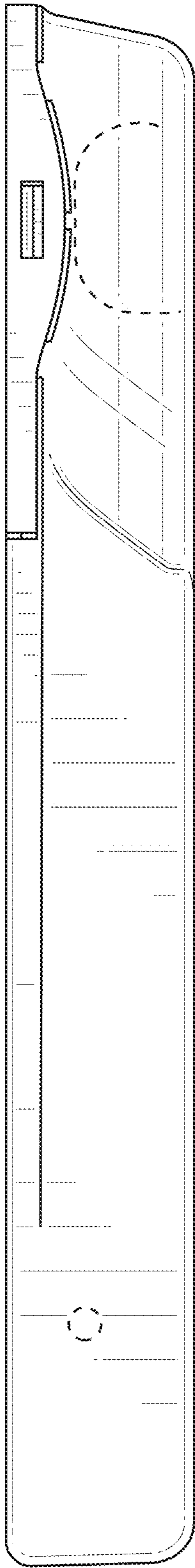

FIG. 11

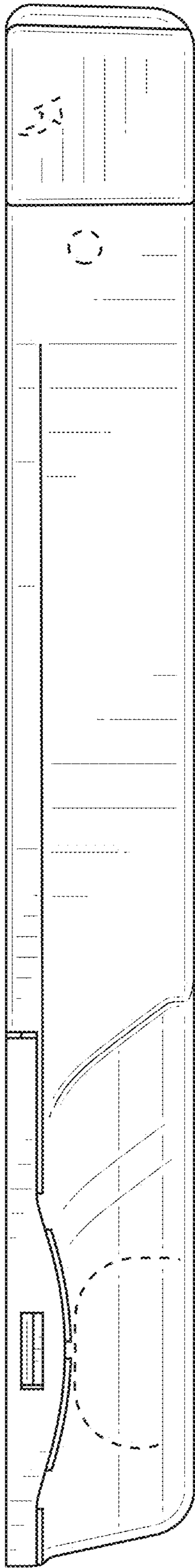

FIG. 12

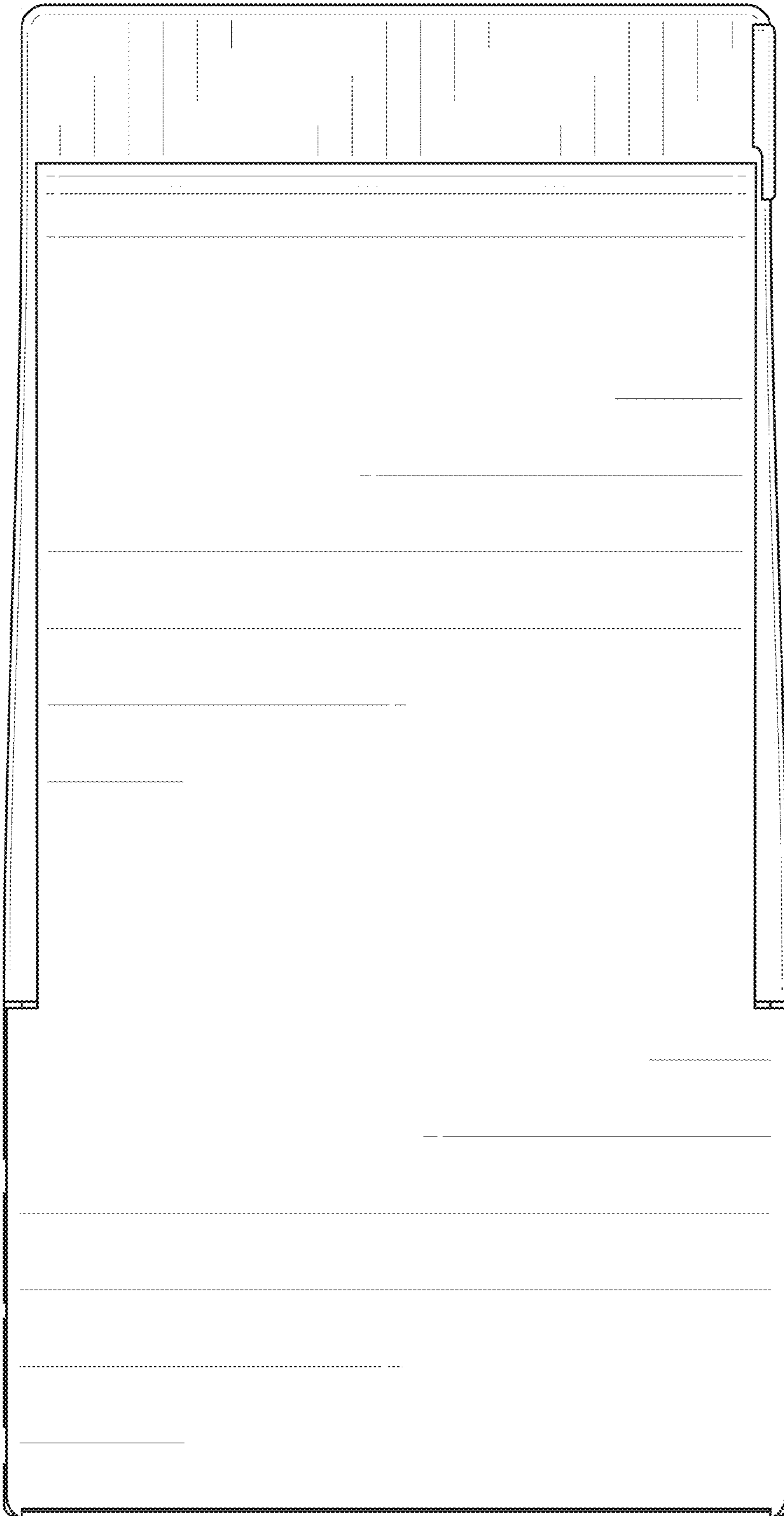

FIG. 13

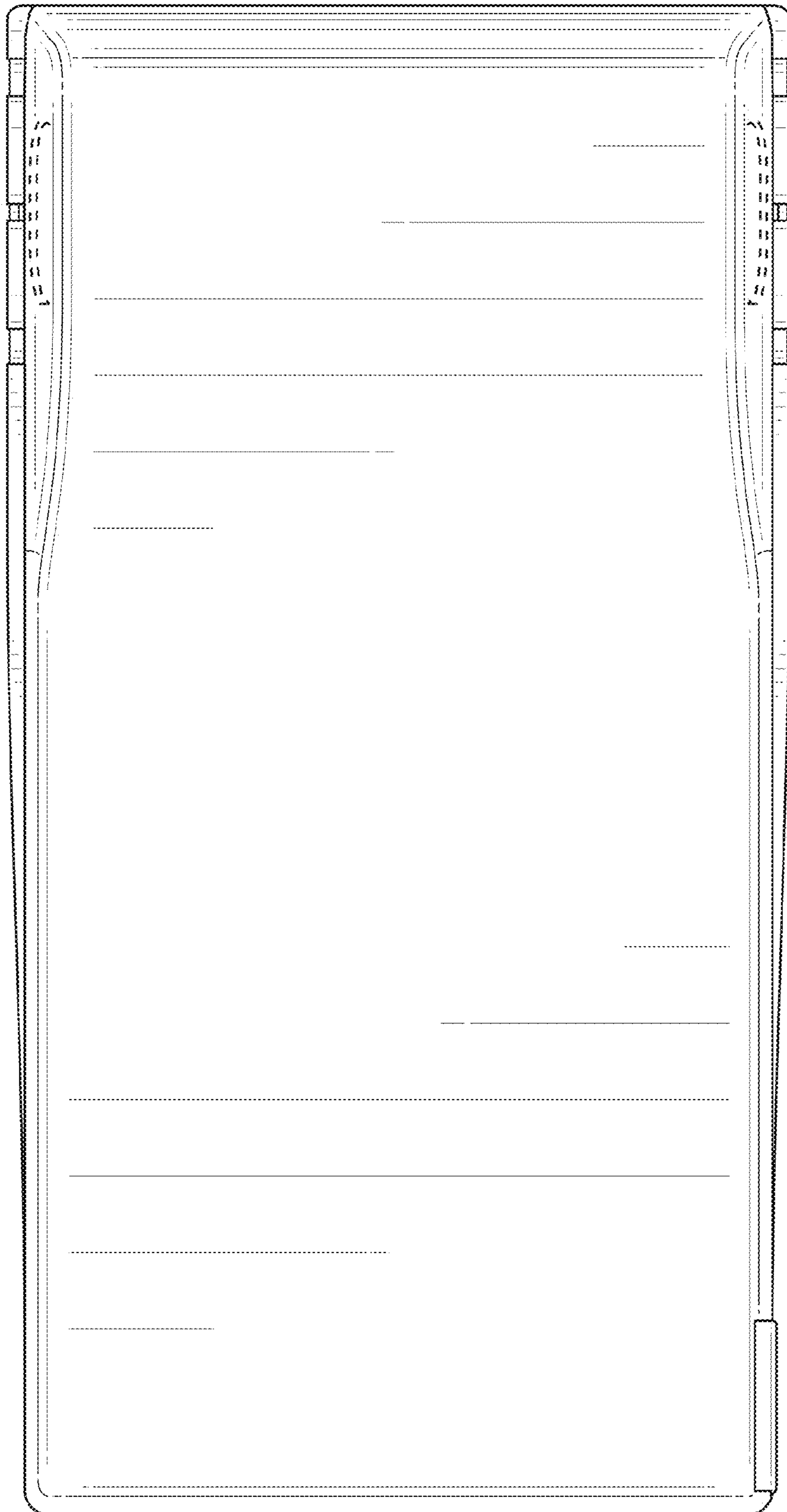

FIG. 14