



US00D893013S

(12) **United States Design Patent** (10) **Patent No.:** **US D893,013 S**
Higgins et al. (45) **Date of Patent:** **** Aug. 11, 2020**

(54) **CUSHION FOR MASK FOR CPAP THERAPY**

FOREIGN PATENT DOCUMENTS

(71) Applicant: **KONINKLIJKE PHILIPS N.V.**,
Eindhoven (NL)

JP D1333105 * 6/2008
WO WO-2014091322 A1 * 6/2014 A61M 16/06
(Continued)

(72) Inventors: **Eric Alan Higgins**, Cheswick, PA (US);
Kevin Daniel Himes, Irwin, PA (US);
Jonathan Sayer Grashow, Cheswick,
PA (US); **Elizabeth Eury**, Latrobe, PA
(US)

OTHER PUBLICATIONS

(73) Assignee: **KONINKLIJKE PHILIPS N.V.**,
Eindhoven (NL)

Easy Breathe, Inc. Link: https://www.easybreathe.com/-p4707.html?gclid=EAla1QobChMI01_34qm04AIVCFqGCh3bxw5HEAQYBSABEgJIK_D_BwE. Apr. 8, 2018. DreamWear Full Face Mask with Headgear. (Year: 2018).*
(Continued)

(**) Term: **15 Years**

Primary Examiner — Lauren D McVey

(21) Appl. No.: **29/616,625**

(57) **CLAIM**

(22) Filed: **Sep. 7, 2017**

The ornamental design for a cushion for mask for CPAP therapy, as shown.

Related U.S. Application Data

DESCRIPTION

(62) Division of application No. 35/500,815, filed on Oct. 9, 2015 (U.S. filing date under 35 U.S.C. 384), and
(Continued)

(30) **Foreign Application Priority Data**

May 21, 2015 (EM) 002704551-0001
May 21, 2015 (EM) 002704551-0002
May 21, 2015 (EM) 002704551-0003

FIG. 1 is a perspective view of a cushion for mask for CPAP therapy showing my design with environment;
FIG. 2 is a front elevation view thereof;
FIG. 3 is a rear elevation view thereof;
FIG. 4 is a right side elevation view thereof;
FIG. 5 is a left side elevation view thereof;
FIG. 6 is a top plan view thereof;
FIG. 7 is a bottom plan view thereof;
FIG. 8 is a perspective view of the cushion for mask for CPAP therapy showing my design without environment;
FIG. 9 is a front elevation view thereof;
FIG. 10 is a rear elevation view thereof;
FIG. 11 is a right side elevation view thereof;
FIG. 12 is a left side elevation view thereof;
FIG. 13 is a top plan view thereof; and,
FIG. 14 is a bottom plan view thereof.
The broken lines in the figures illustrate environment and form no part of the claimed design.

(51) **LOC (12) Cl.** **29-02**

(52) **U.S. Cl.**
USPC **D24/110.4**

(58) **Field of Classification Search**
USPC D24/110, 110.1–110.6, 164, 165, 168
(Continued)

(56) **References Cited**

U.S. PATENT DOCUMENTS

D653,748 S * 2/2012 Henry D24/110.1
D692,554 S 10/2013 Siew
(Continued)

1 Claim, 11 Drawing Sheets

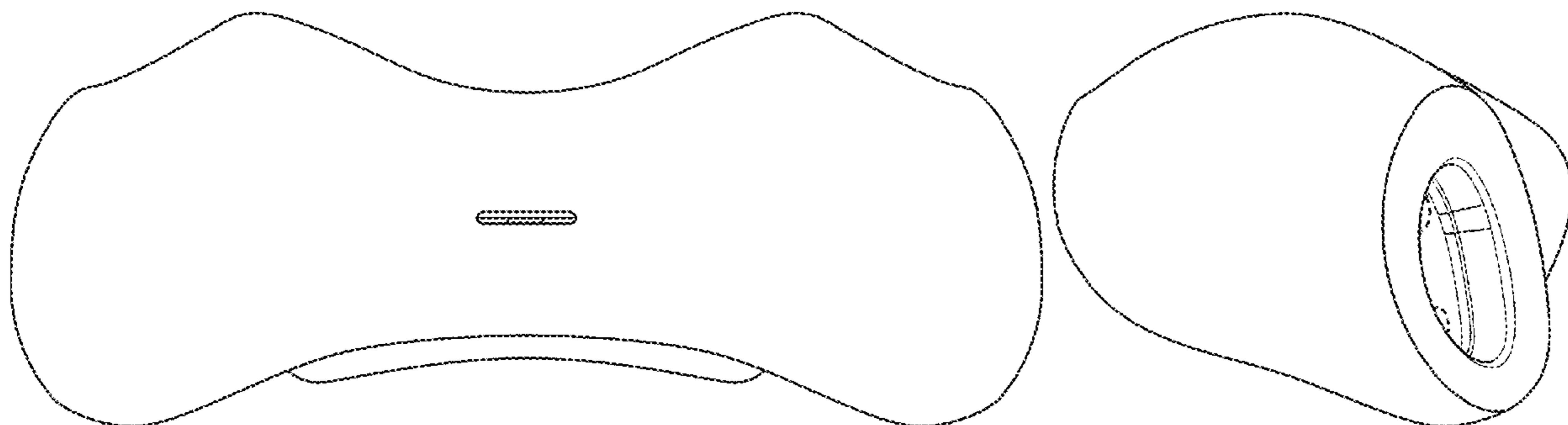

Related U.S. Application Data

having an international filing date of Oct. 9, 2015, now Pat. No. Des. 799,699.

(58) **Field of Classification Search**

CPC A61M 16/06; A61M 2205/06; A61M 16/0066; A61M 2210/0625; A61M 16/0611; A61M 16/0616; A61M 16/0622; A61M 16/0633; A61M 16/0683; A61M 16/00066; A61M 16/0666; A61B 5/4818; A61B 5/0833; A61B 5/087

See application file for complete search history.

(56) **References Cited**

U.S. PATENT DOCUMENTS

D696,767 S 12/2013 Scheiner
 D709,181 S 7/2014 Henry
 8,985,115 B2 3/2015 Baecke
 D729,391 S 5/2015 Igwebuike et al.
 D742,501 S * 11/2015 Chen D24/110
 D742,502 S * 11/2015 Chen D24/110
 D743,021 S * 11/2015 Chen D24/110
 D745,139 S * 12/2015 Chen D24/110
 D749,205 S * 2/2016 Chen D24/110
 D770,036 S 10/2016 Walls
 9,572,947 B2 2/2017 Grashow
 D787,662 S * 5/2017 Guney D24/110.4
 D799,699 S * 10/2017 Higgins D24/164

D829,322 S * 9/2018 Eury D24/110.4
 D869,642 S * 12/2019 Andrews D24/110.4
 D872,257 S * 1/2020 Andrews D24/110.4
 2008/0047560 A1* 2/2008 Veliss A61M 16/06
 128/206.24
 2008/0190432 A1 8/2008 Blochlinger et al.
 2009/0223518 A1* 9/2009 Kwok A61M 16/06
 128/205.25
 2012/0067349 A1 3/2012 Barlow
 2013/0199537 A1 8/2013 Formica
 2013/0220327 A1 8/2013 Barlow
 2014/0264975 A1 9/2014 Bath et al.
 2015/0083136 A1 3/2015 Grashow et al.
 2015/0182719 A1 7/2015 Grashow et al.
 2016/0008564 A1 1/2016 Grashow et al.
 2016/0067436 A1 3/2016 Grashow
 2016/0074611 A1 3/2016 Higgins et al.

FOREIGN PATENT DOCUMENTS

WO WO-2016108116 A1 * 7/2016 A61M 16/06
 WO WO-2018177794 A1 * 10/2018 A62B 18/10

OTHER PUBLICATIONS

YouTube. Link: <https://www.youtube.com/watch?v=RUwla3xnsDQ>.
 Apr. 30, 2018. TheLankyLefty27 Dreamwear Full Face Mask
 Review and Buy Cheap!! Philips Respironics. (Year: 2018).*

* cited by examiner

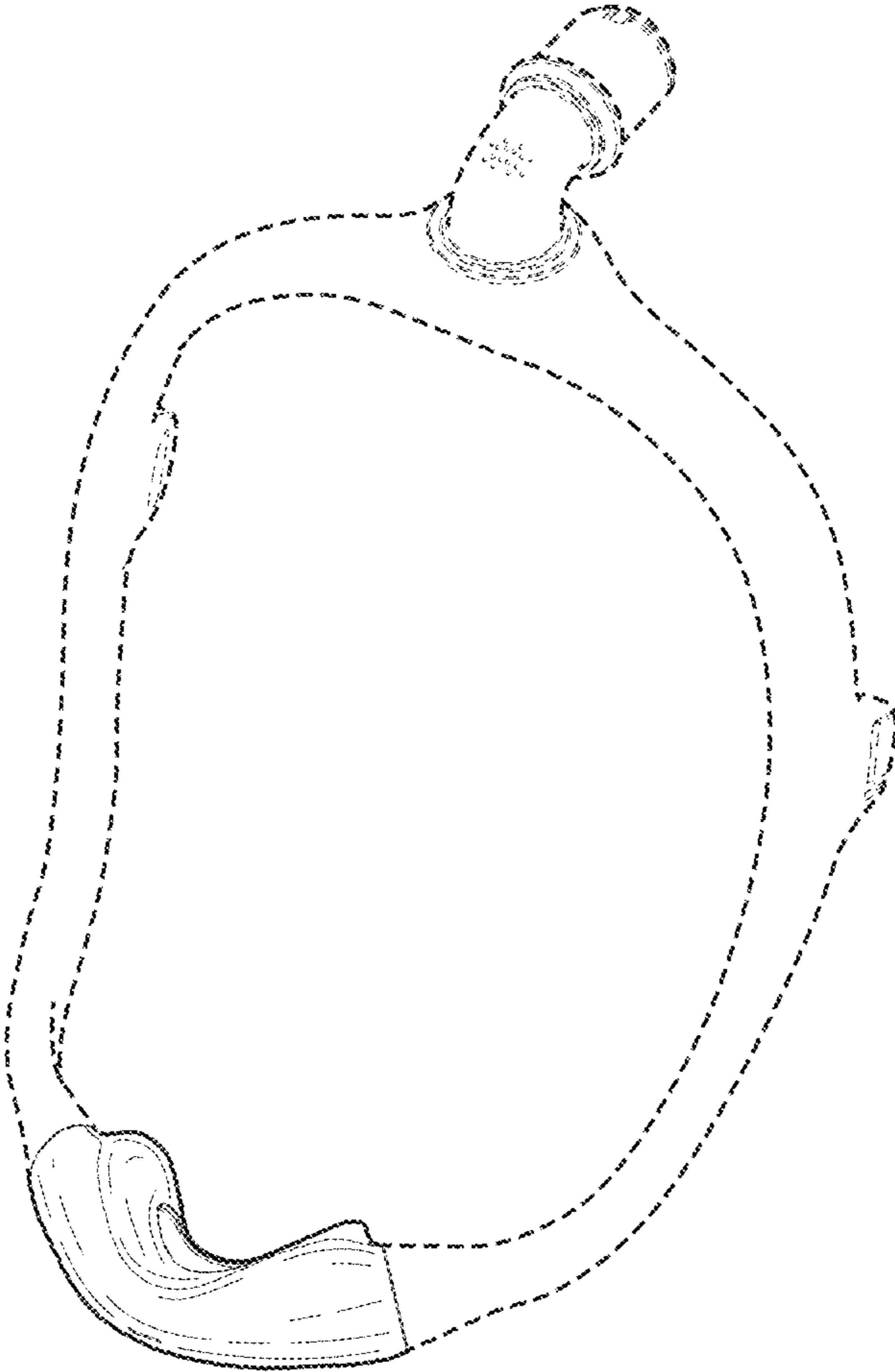

FIG. 1

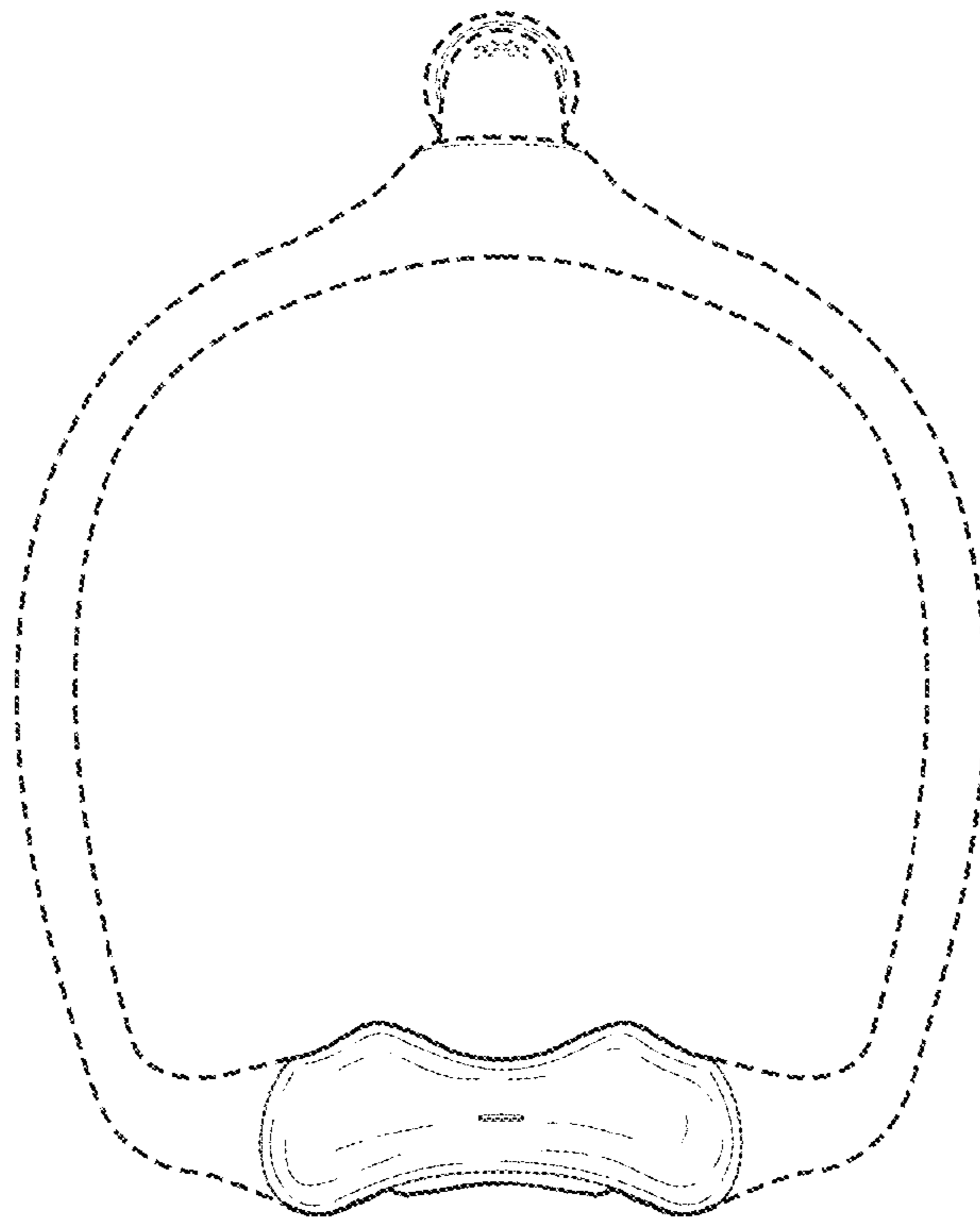

FIG. 2

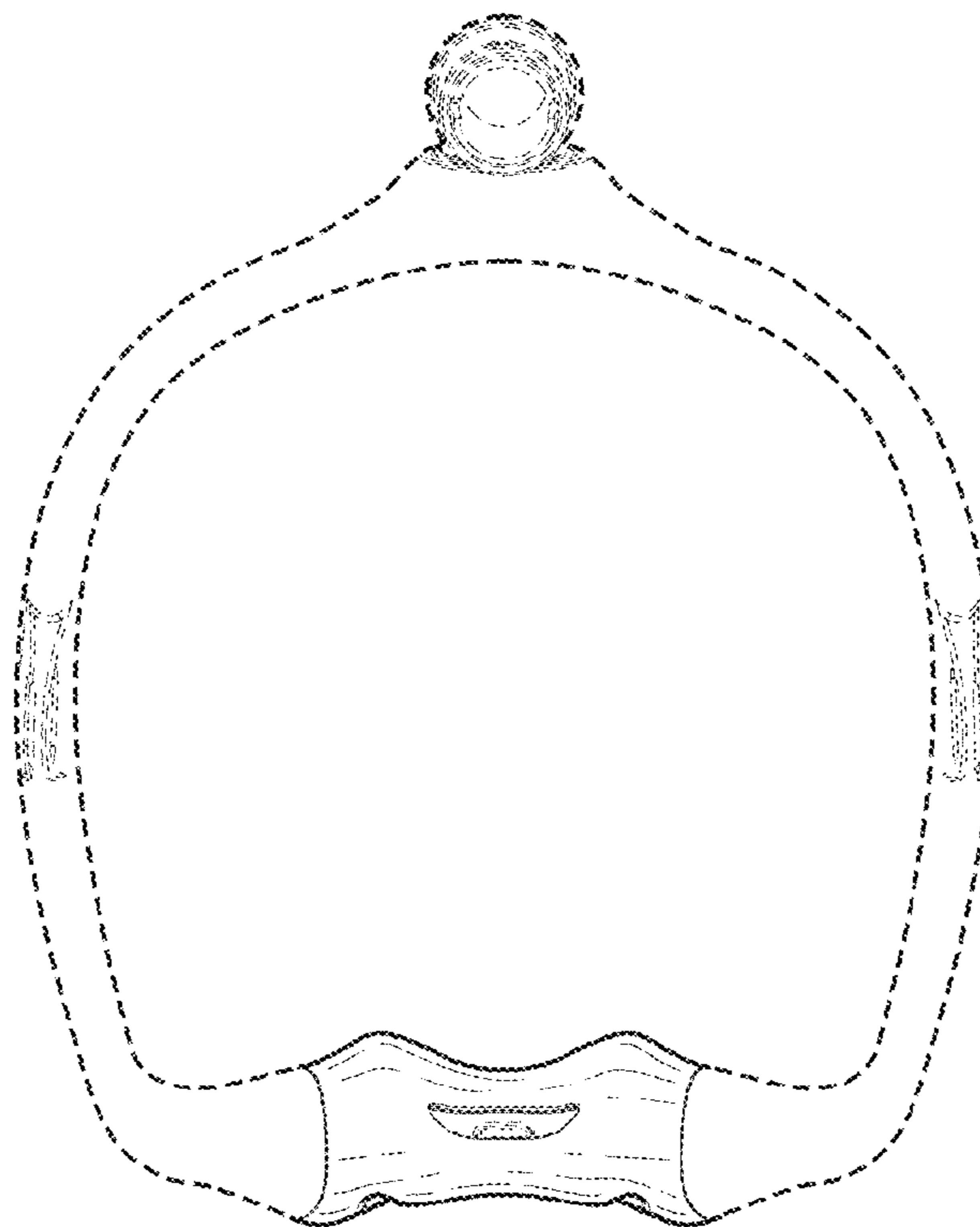

FIG. 3

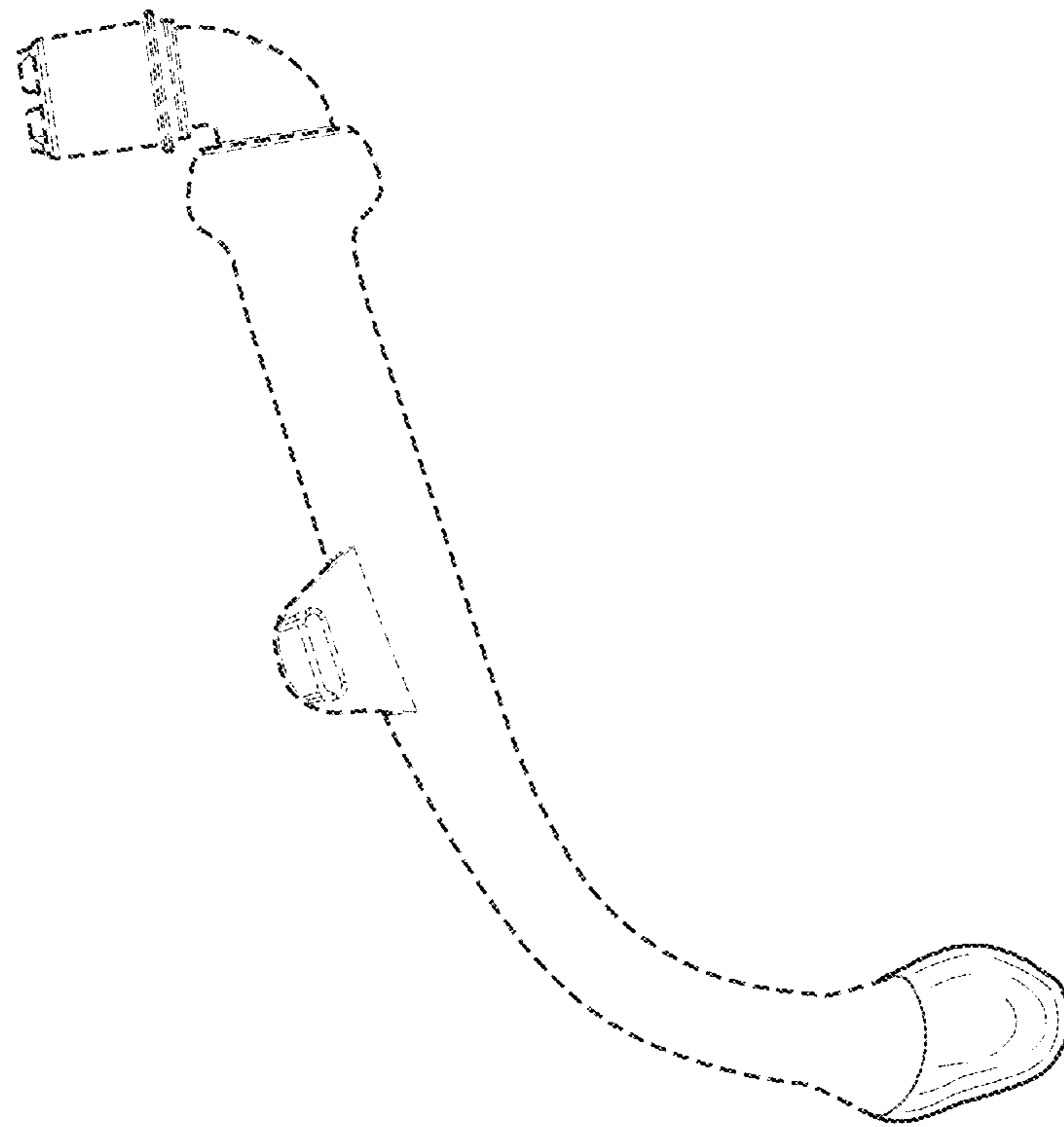

FIG. 4

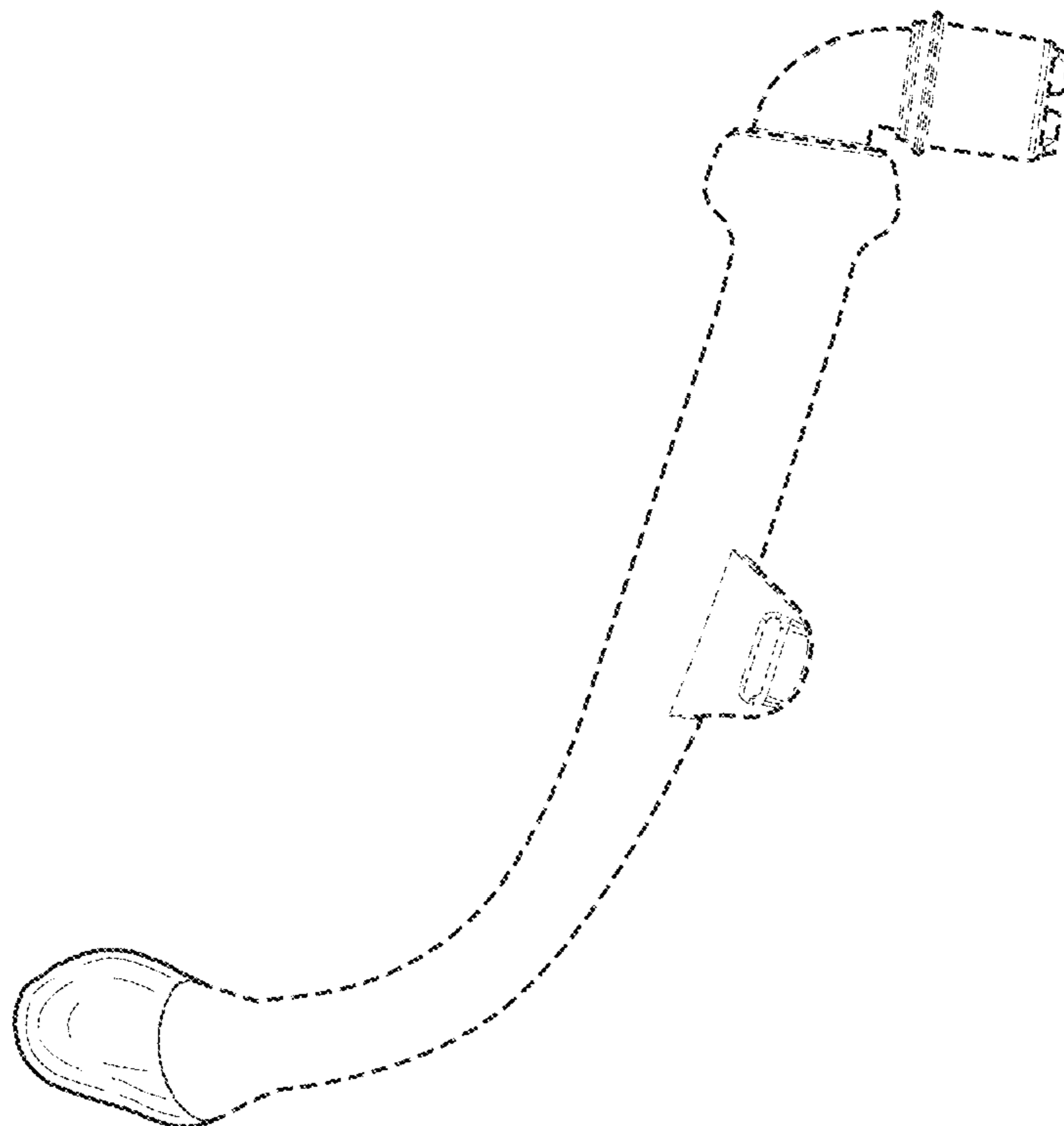

FIG. 5

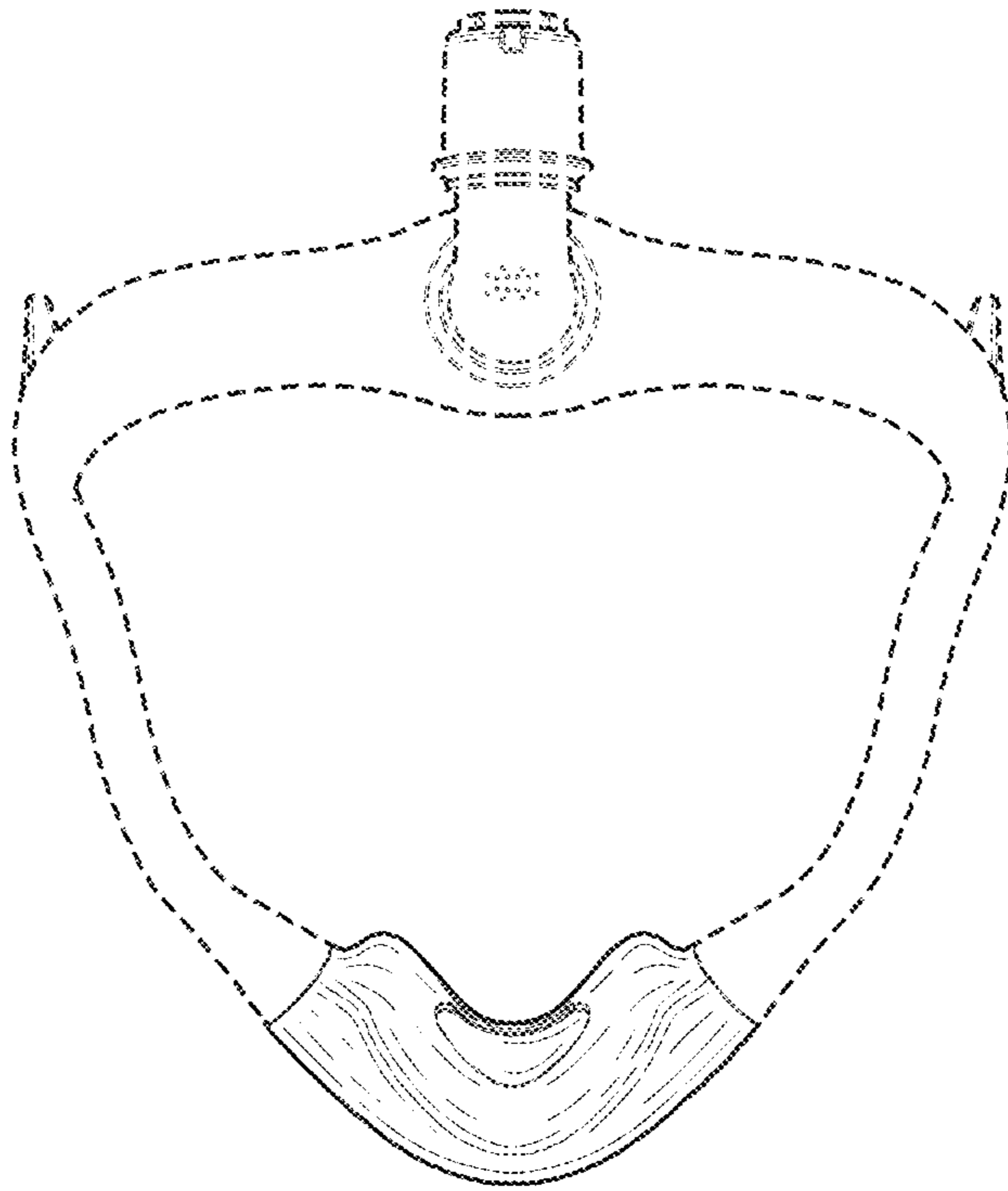

FIG. 6

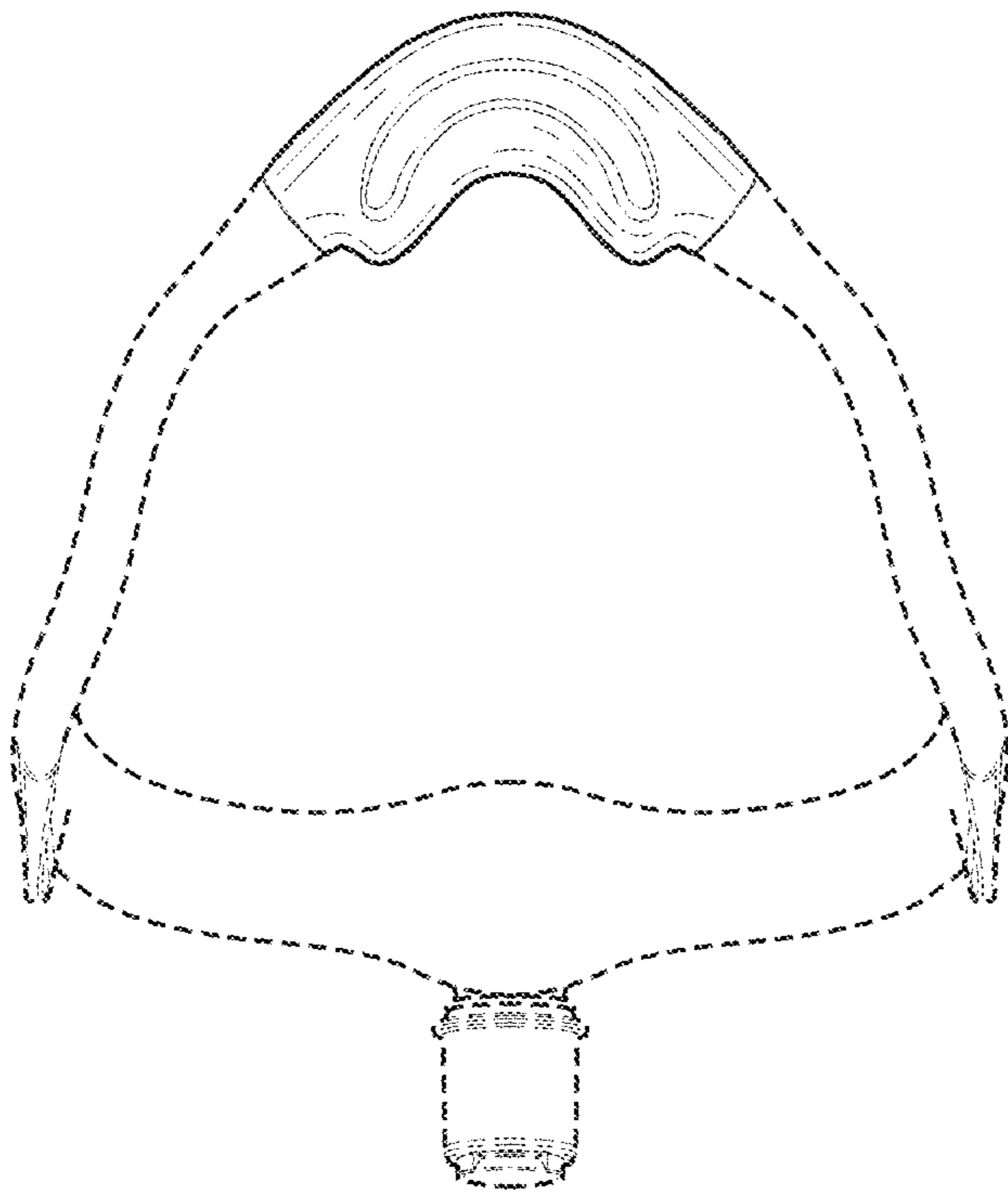

FIG. 7

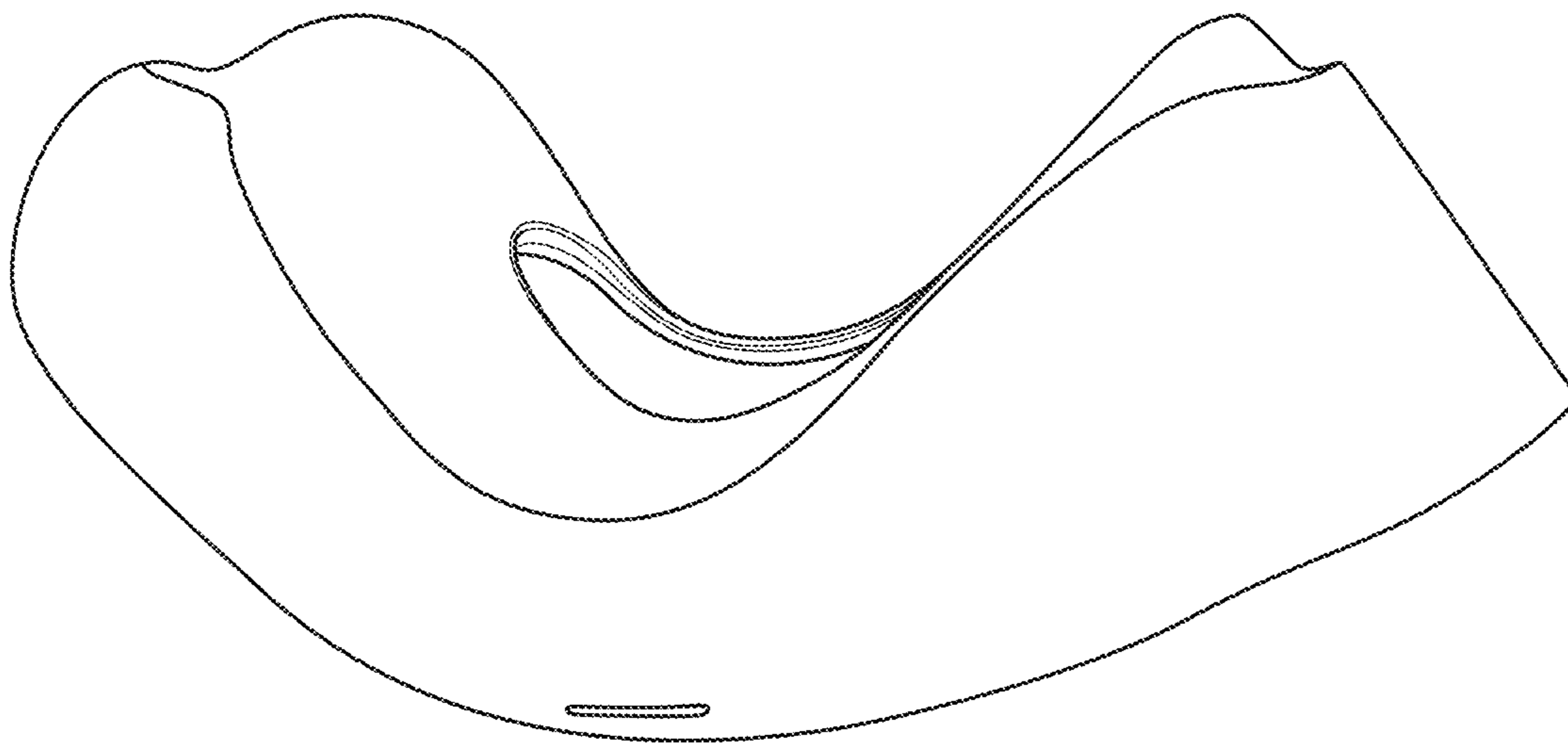

FIG. 8

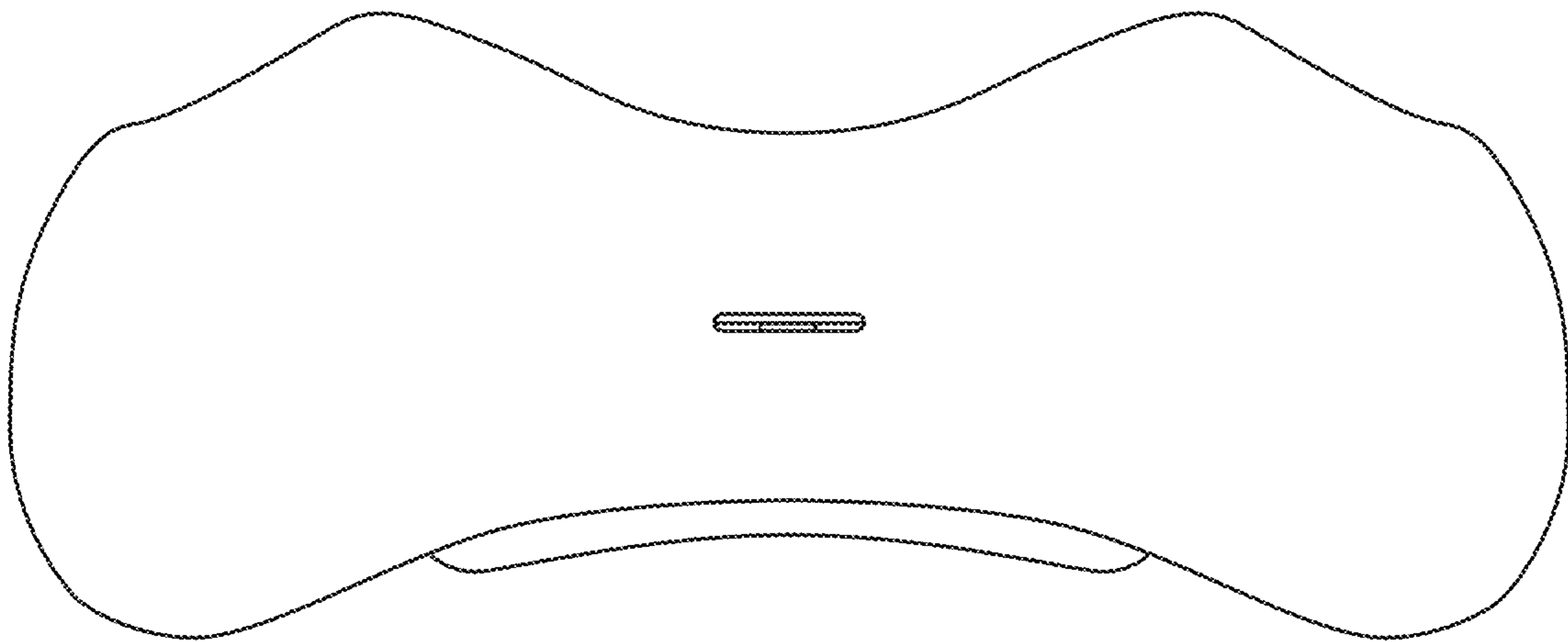

FIG. 9

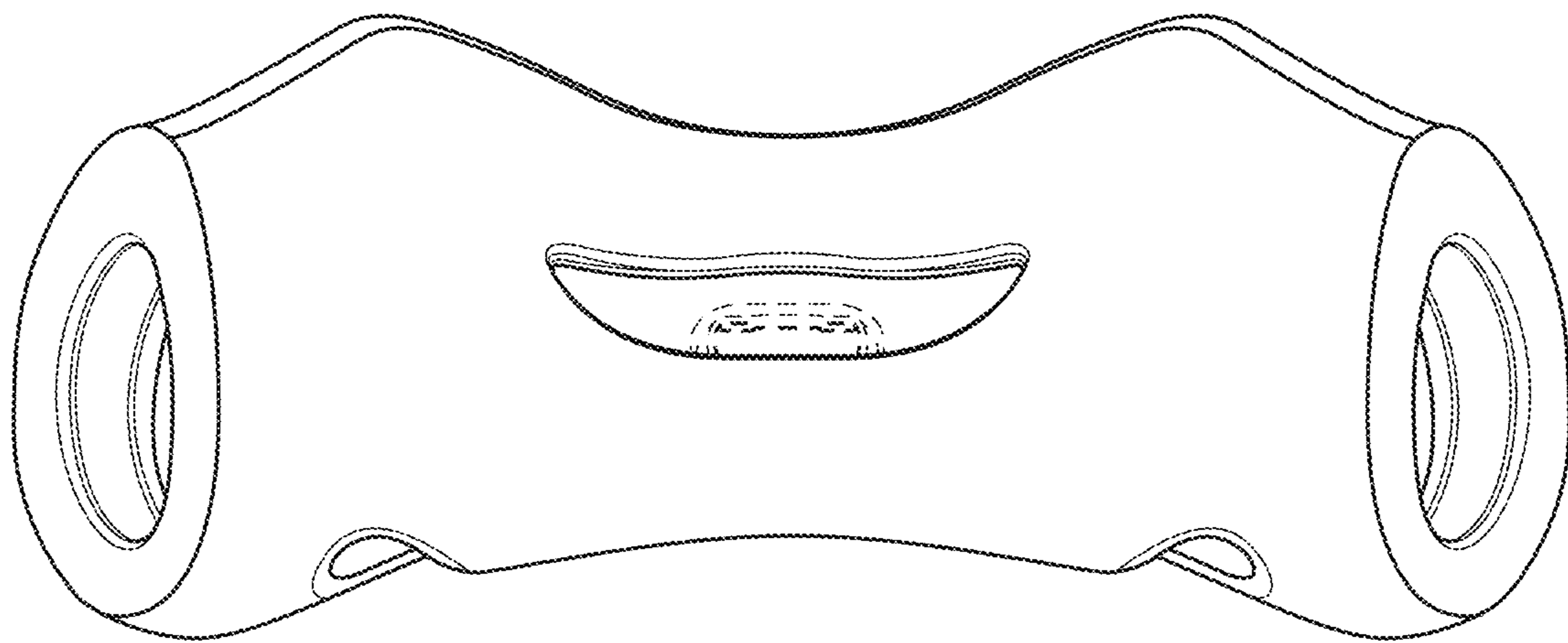

FIG. 10

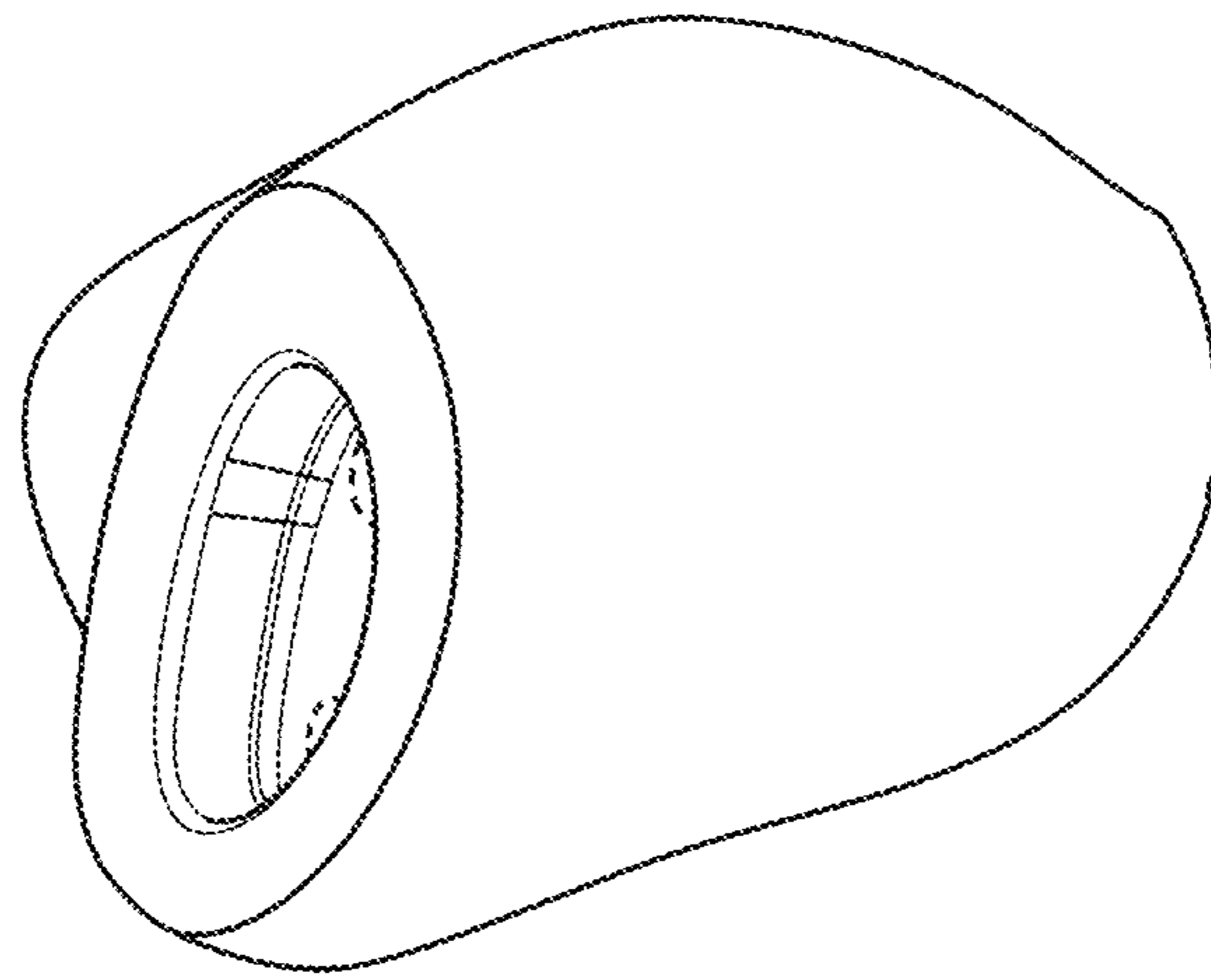

FIG. 11

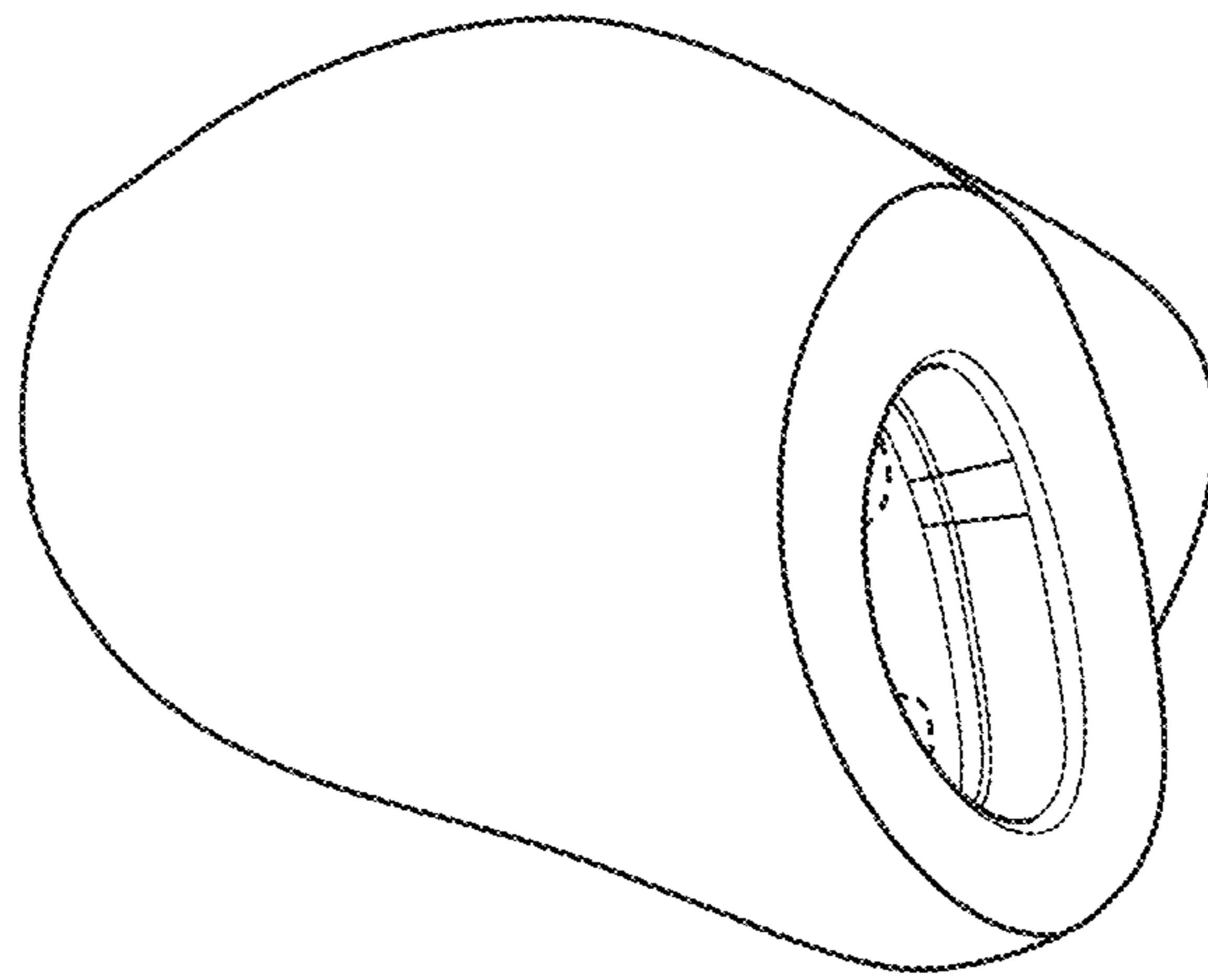

FIG. 12

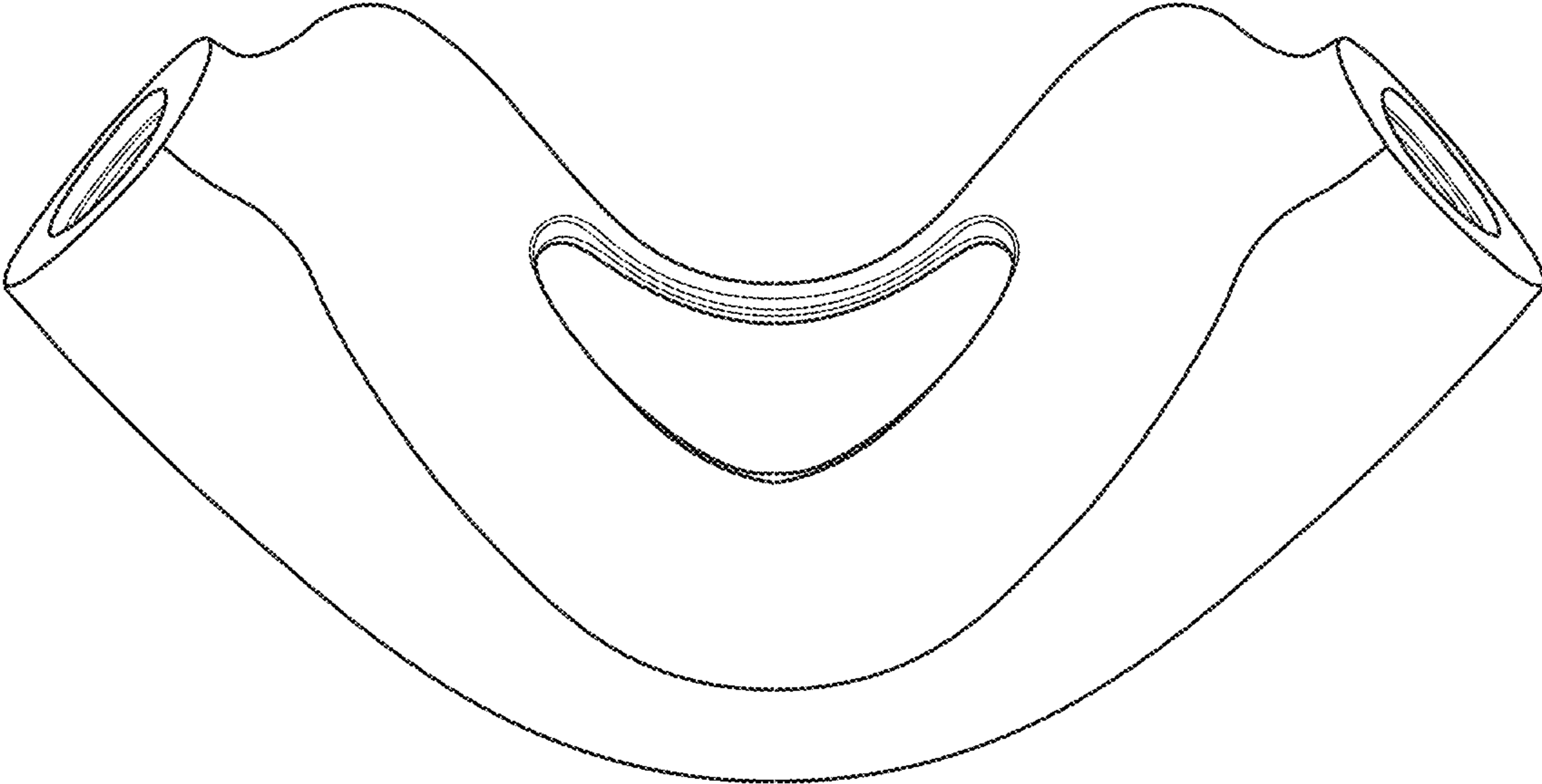

FIG. 13

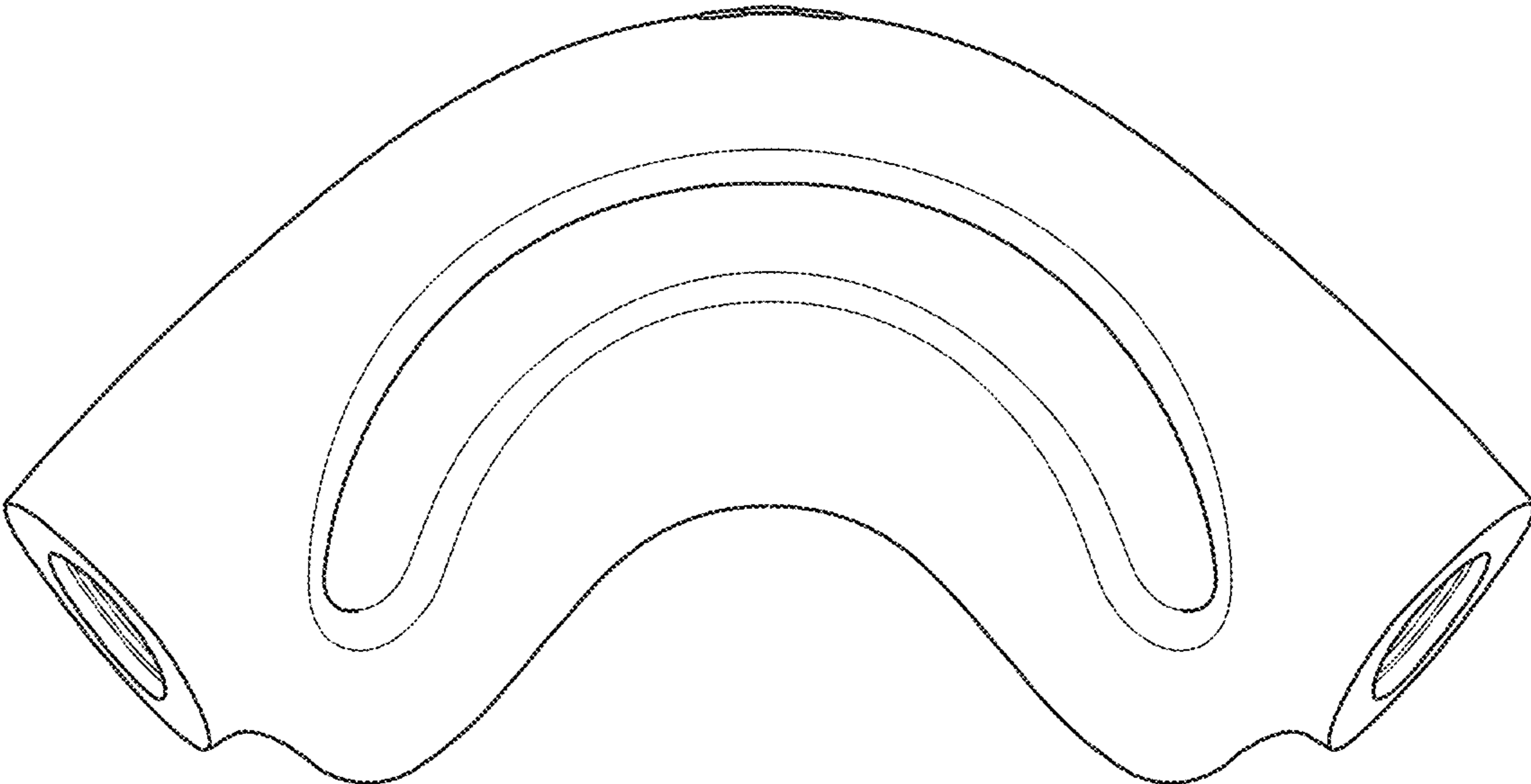

FIG. 14