



US00D893005S

(12) **United States Design Patent** (10) **Patent No.:** **US D893,005 S**
Farrer (45) **Date of Patent:** **** Aug. 11, 2020**

- (54) **PORTABLE AUDIO-DRIVEN FIRE PIT**
- (71) Applicant: **TK PRODUCTS, LLC**, Vancouver, WA (US)
- (72) Inventor: **Trent Farrer**, Vancouver, WA (US)
- (73) Assignee: **TK HOLDINGS, LLC**, Vancouver, WA (US)
- (**) Term: **15 Years**
- (21) Appl. No.: **29/674,154**
- (22) Filed: **Dec. 19, 2018**
- (51) **LOC (12) Cl.** **23-03**
- (52) **U.S. Cl.**
USPC **D23/343**
- (58) **Field of Classification Search**
USPC D23/314, 332, 334, 335, 336, 337, 338, D23/339, 340, 341, 342, 343, 344, 403, D23/499; D7/332-337, 402-405, 352; D26/8
CPC F24C 1/16; F24C 5/00; F24C 3/14; A47J 33/00; A47J 37/0763; A47J 37/07; F24B 1/18; F24B 1/182; F24B 1/1808; F24B 1/181; F24B 1/195; F24B 1/191; F23N 1/002; F23N 5/203
See application file for complete search history.

- D857,863 S * 8/2019 Pontillas D23/332
- D857,864 S * 8/2019 Inovero D23/332
- 2008/0308645 A1* 12/2008 Presley B05B 17/08 239/17
- 2012/0222668 A1* 9/2012 Unger F24B 1/181 126/544
- 2018/0010807 A1* 1/2018 Brakhage F24C 15/06
- 2018/0279828 A1* 10/2018 Kaiser F24B 3/00
- 2019/0285274 A1* 9/2019 Chen F23C 99/003
- 2019/0383490 A1* 12/2019 Paladino F24B 1/192

* cited by examiner

Primary Examiner — T Chase Nelson
Assistant Examiner — Ania Aman
 (74) *Attorney, Agent, or Firm* — FisherBroyles LLP; Micah D. Stolowitz

(57) **CLAIM**
 I claim, the ornamental design for a portable audio-driven fire pit, as shown and described.

DESCRIPTION

FIG. 1 is a perspective view of my design for a portable audio-driven fire pit shown without the lid and handle. FIG. 2 is a front elevation view of my design. FIG. 3 is a back elevation view of my design. FIG. 4 is a left side elevation view of my design. FIG. 5 is a right side elevation view of my design. FIG. 6 is a top view of my design; and, FIG. 7 is a perspective view of my design for a portable audio-driven fire pit shown with the lid and handle. The broken lines showing portions of the portable audio-driven figure pit is for the purpose of illustrating environmental structure and forms no part of the claimed design.

- (56) **References Cited**
 U.S. PATENT DOCUMENTS
 D698,908 S * 2/2014 Krieger D23/314
 D805,171 S * 12/2017 Hrydovyy D23/343

1 Claim, 5 Drawing Sheets

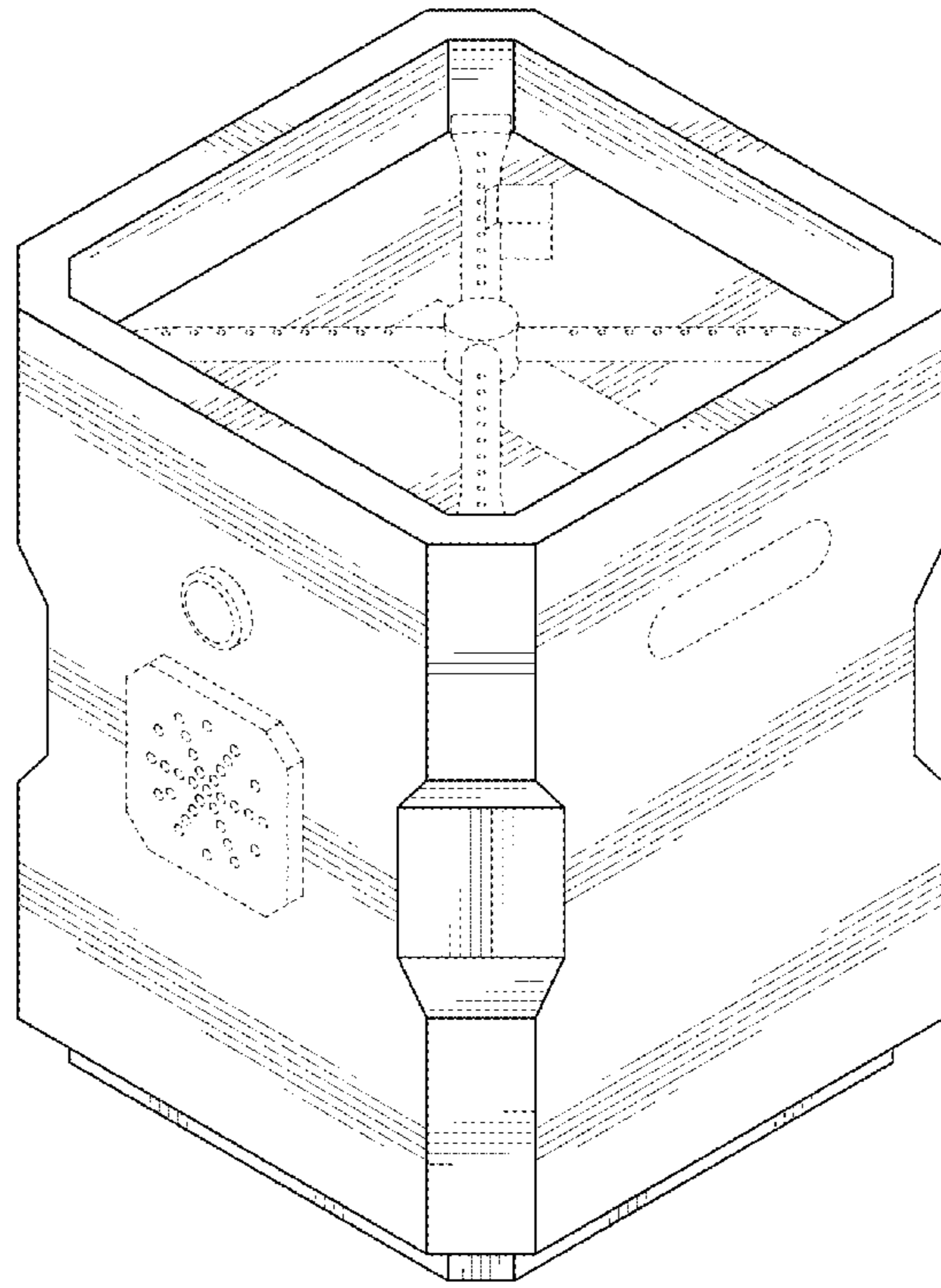

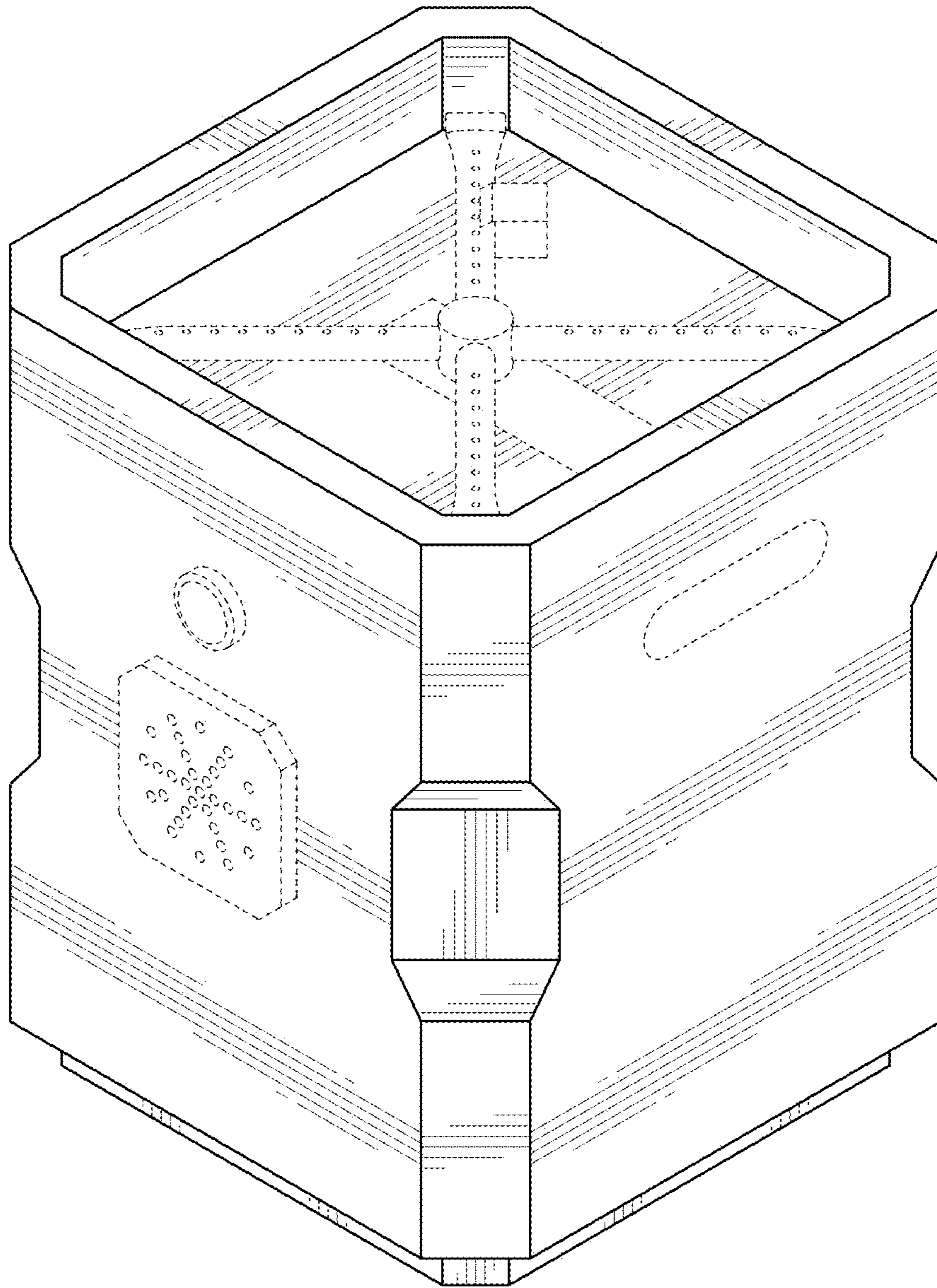

FIG. 1

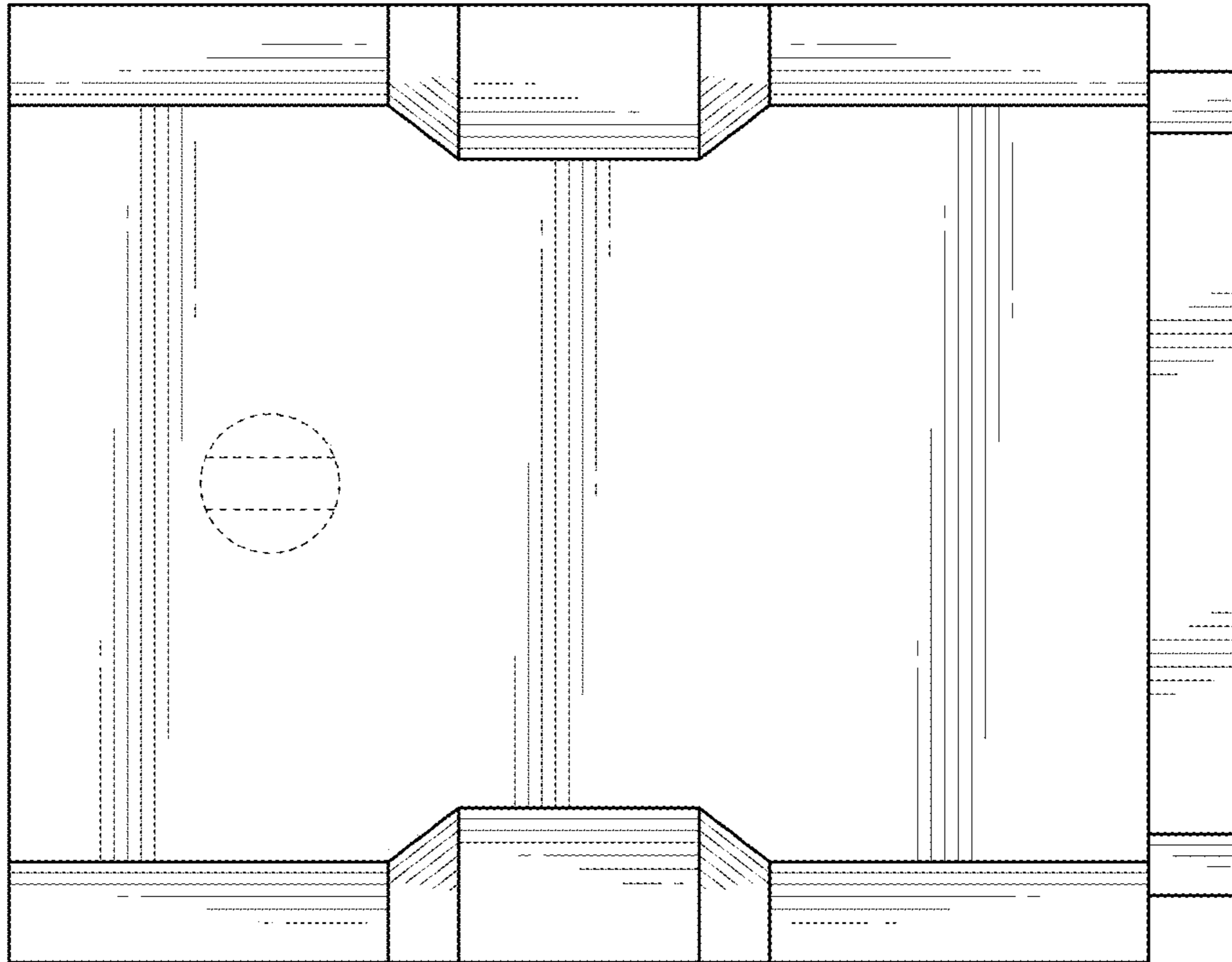

FIG. 2

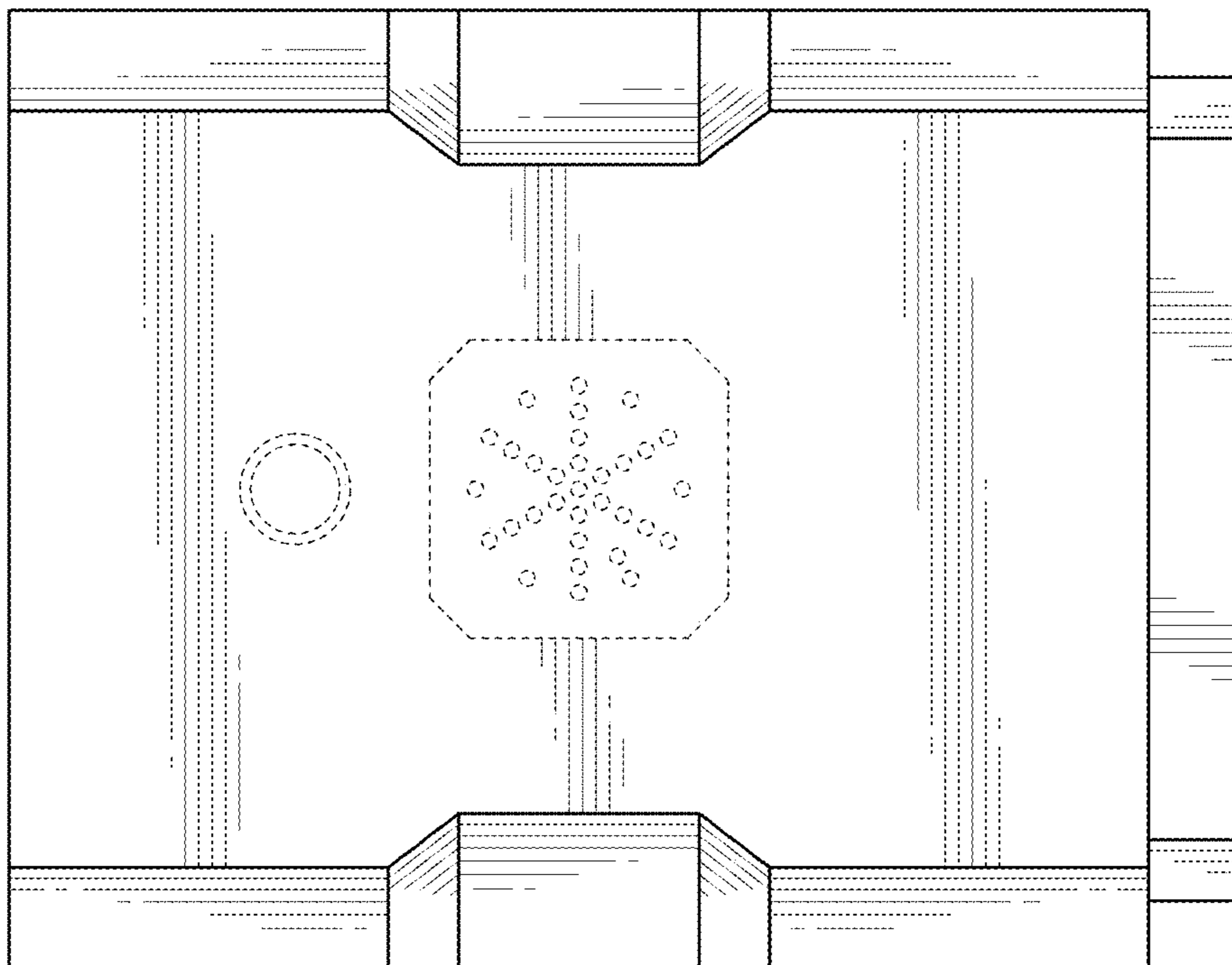

FIG. 3

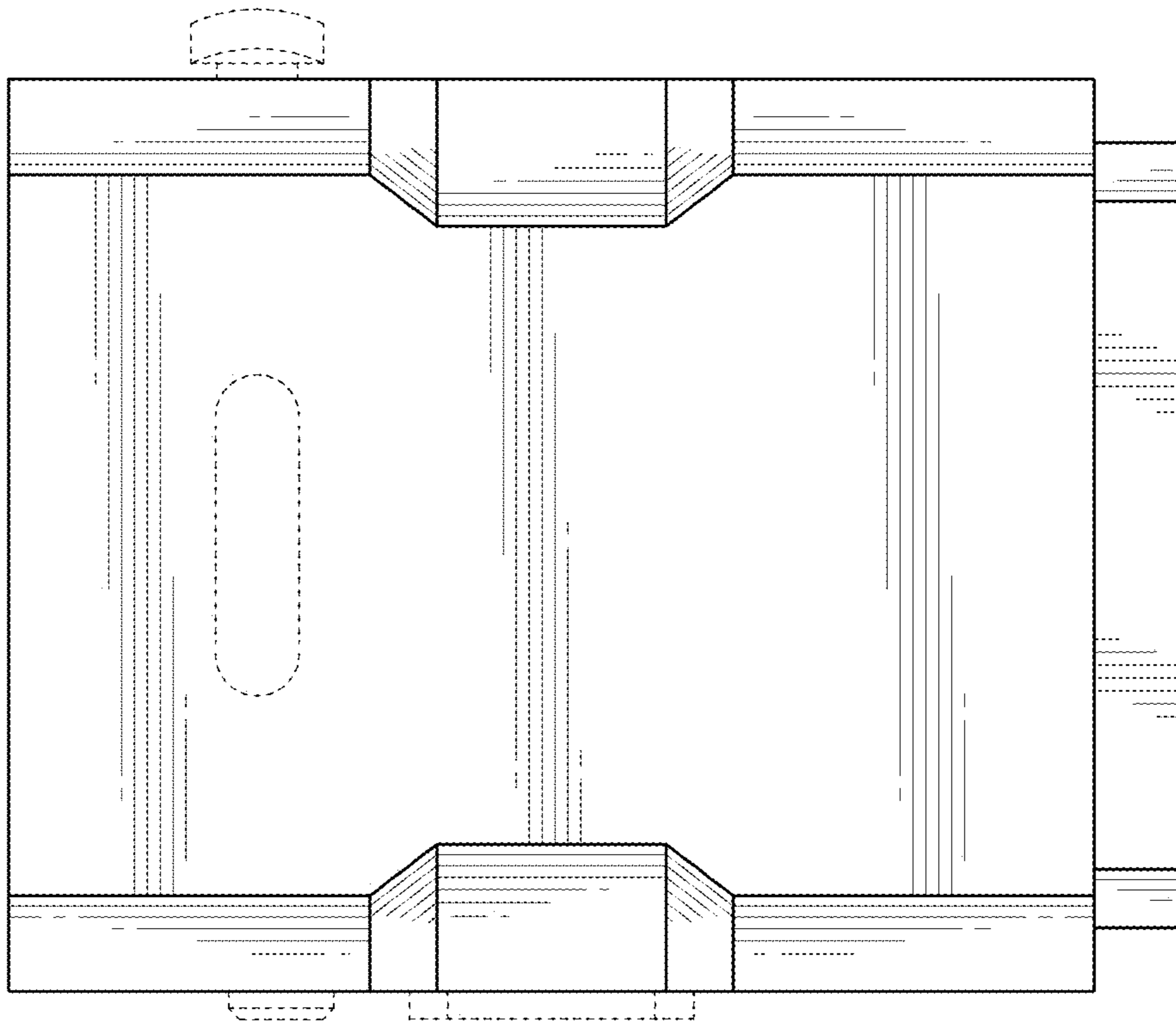

FIG. 5

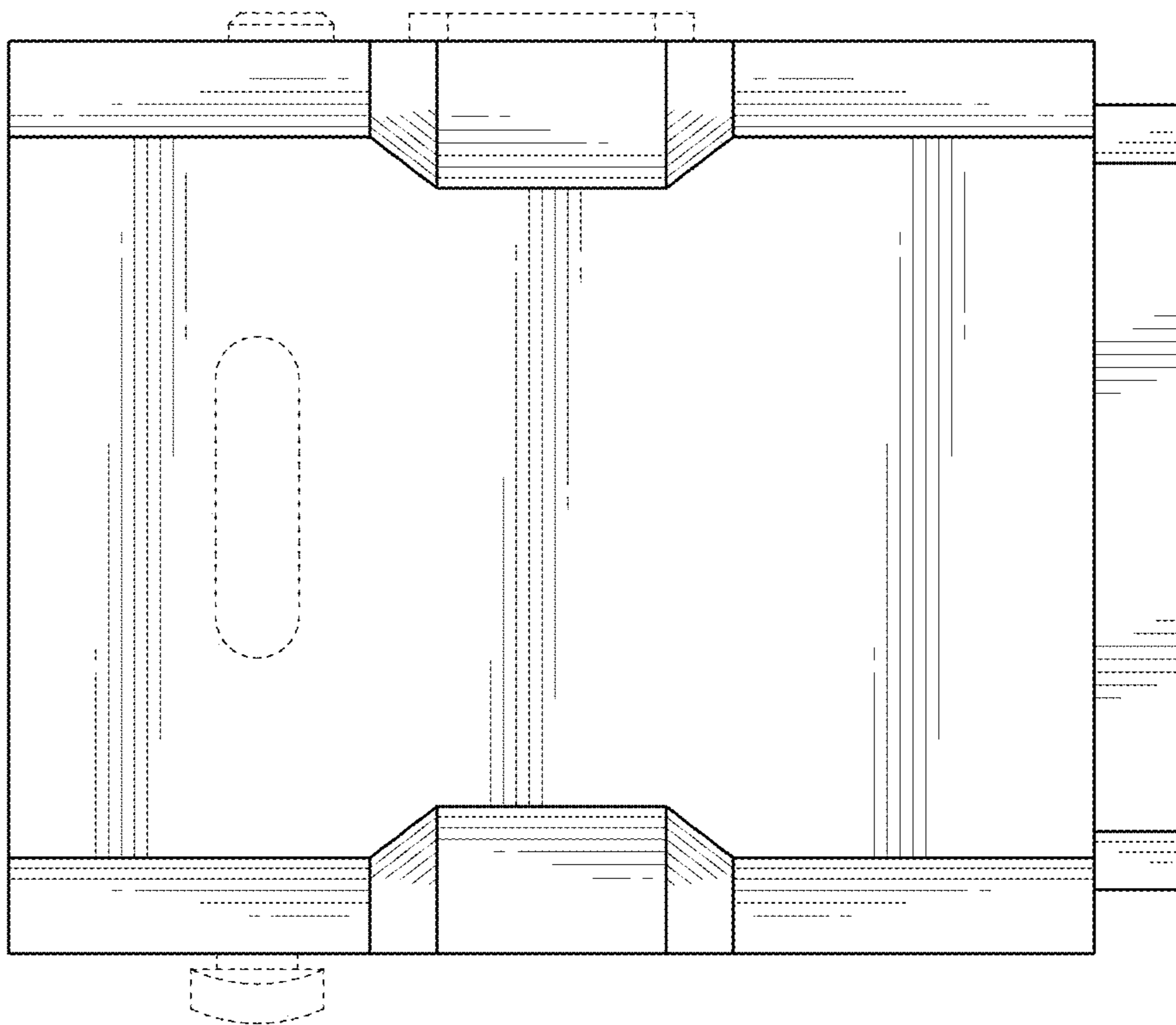

FIG. 4

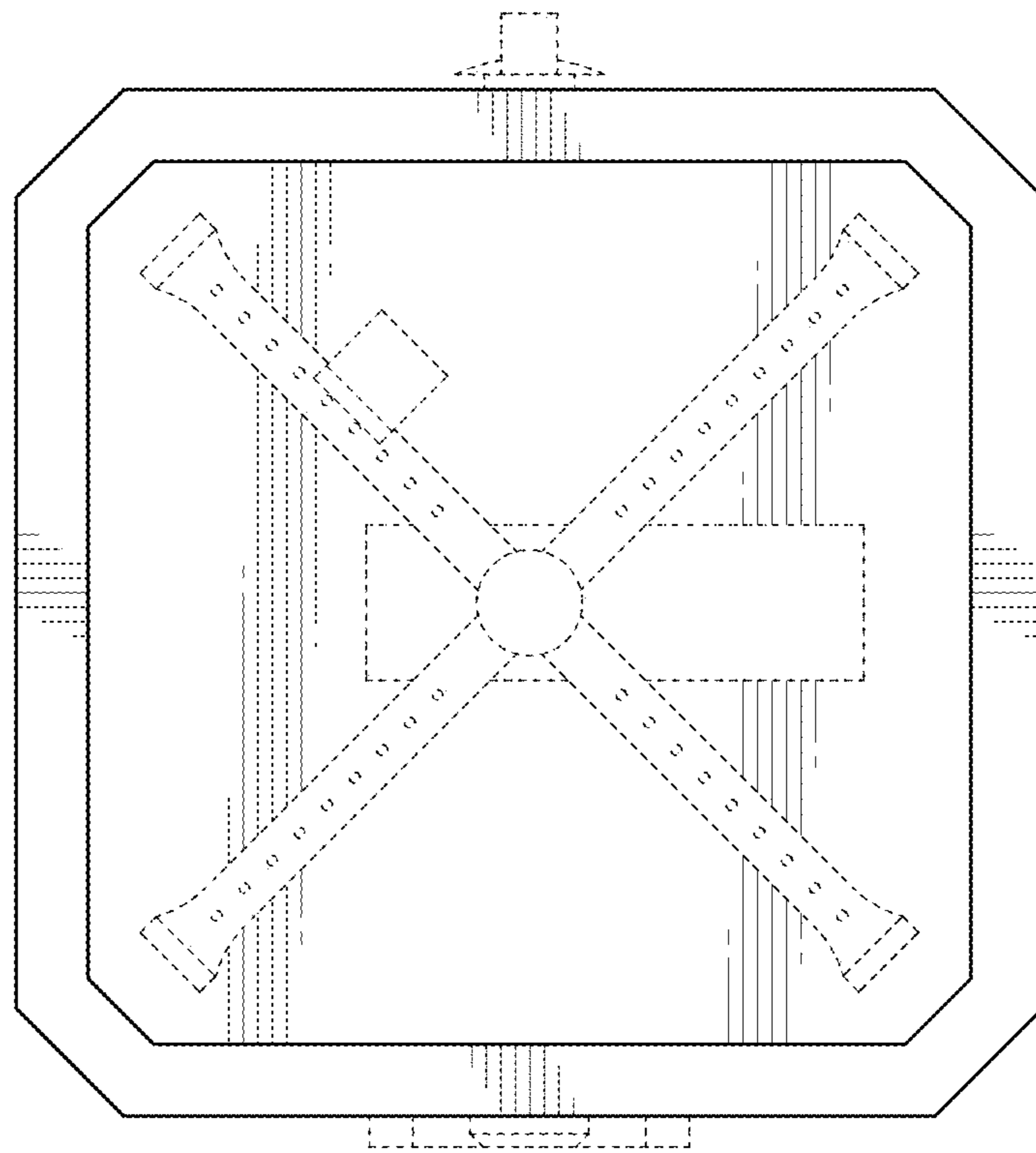

FIG. 6

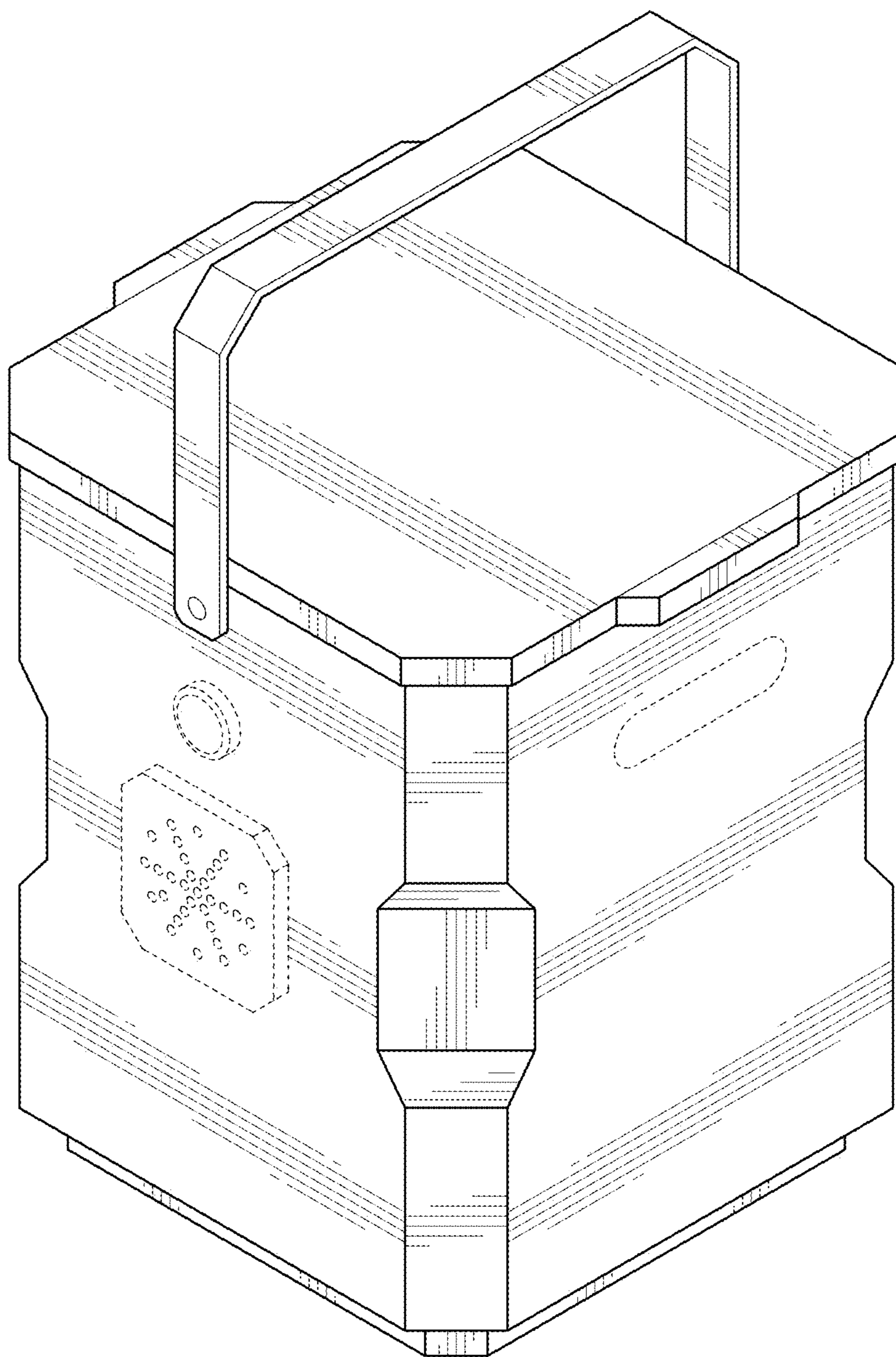

FIG. 7