



US00D892884S

(12) **United States Design Patent**
Okamoto

(10) **Patent No.:** **US D892,884 S**

(45) **Date of Patent:** **** Aug. 11, 2020**

(54) **POWER RECEIVING UNIT OF AN INDUSTRIAL ROBOT ARM**

(71) Applicant: **Daihen Corporation**, Osaka-shi (JP)

(72) Inventor: **Kentaro Okamoto**, Osaka (JP)

(73) Assignee: **Daihen Corporation**, Osaka-shi (JP)

(**) Term: **15 Years**

(21) Appl. No.: **29/664,627**

(22) Filed: **Sep. 26, 2018**

(30) **Foreign Application Priority Data**

Mar. 29, 2018 (JP) 2018-006769

(51) **LOC (12) Cl.** **15-99**

(52) **U.S. Cl.**
USPC **D15/199**

(58) **Field of Classification Search**
USPC D13/182; D15/138, 199
CPC . B25J 9/046; B25J 9/126; B25J 9/1615; B25J 11/0095; B25J 15/0014; G05B 2219/39236; G05B 2219/39251; G05B 2219/40234; H01L 21/67766
See application file for complete search history.

(56) **References Cited**

U.S. PATENT DOCUMENTS

- 4,733,423 A * 3/1988 Blatt A46B 9/02 15/104.04
- 4,928,047 A * 5/1990 Arai B25J 9/042 188/366
- D441,730 S * 5/2001 Oba D13/182
- RE43,781 E * 11/2012 Yoshino D13/182
- RE44,567 E * 11/2013 Yoshino D13/182
- 8,686,599 B2 * 4/2014 Tsuchiya H02J 50/10 307/109
- D802,546 S * 11/2017 Jang D13/182

- D804,436 S * 12/2017 Tauchi D13/182
- 9,912,195 B2 * 3/2018 Homma H02J 50/12
- 10,022,861 B1 * 7/2018 He B25J 19/0075
- D824,967 S * 8/2018 Getto D15/143
- D848,155 S * 5/2019 D'Andreta D4/116
- 10,500,734 B1 * 12/2019 Xiong B25J 9/1025
- 10,583,567 B1 * 3/2020 Larsen B25J 9/126
- 10,589,420 B2 * 3/2020 Matsumoto B25J 9/0096
- 10,593,583 B2 * 3/2020 Bonora H01L 21/67736

(Continued)

FOREIGN PATENT DOCUMENTS

- JP 2012-161858 A 8/2012
- JP 2018034211 A 3/2018
- JP 2018-083241 A 5/2018

Primary Examiner — Patricia A Palasik

(74) *Attorney, Agent, or Firm* — Schwegman Lundberg & Woessner, P.A.

(57) **CLAIM**

The ornamental design for power receiving unit of an industrial robot arm, as shown and described.

DESCRIPTION

FIG. 1 is a perspective view of power receiving unit of an industrial robot arm showing my new design;
FIG. 2 is a front view thereof;
FIG. 3 is a rear view thereof;
FIG. 4 is a top plan view thereof;
FIG. 5 is a bottom plan view thereof;
FIG. 6 is a right side view thereof;
FIG. 7 is a left side view thereof; and,
FIG. 8 is a cross-sectional view taken along line 8-8 in FIG. 5 with the internal structure omitted.

The broken lines illustrate portions of the power receiving unit of an industrial robot arm and form no part of the claimed design. The dash-dotted lines denote the boundary of the claim and form no part of the claimed design.

1 Claim, 8 Drawing Sheets

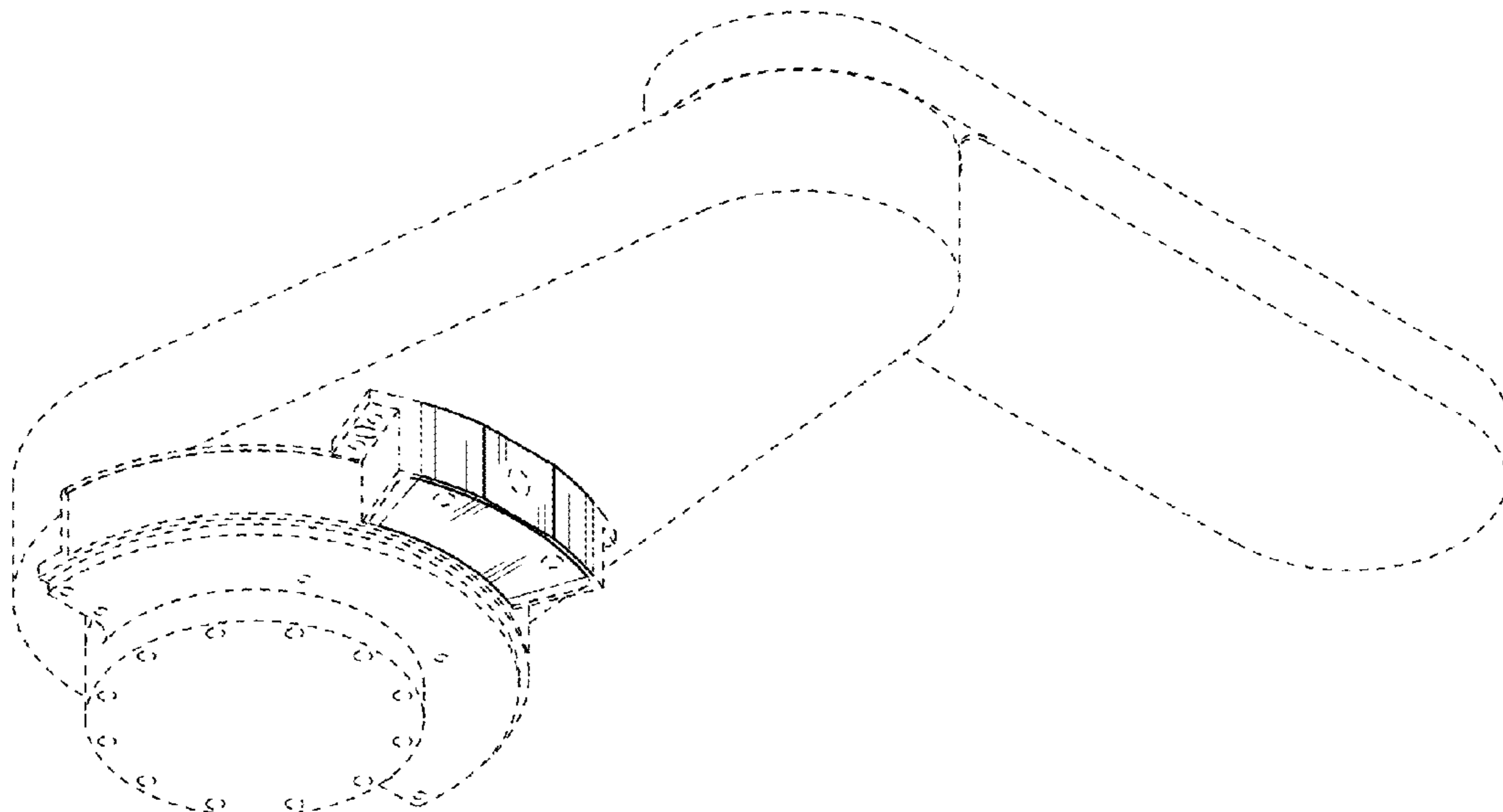

(56)

References Cited

U.S. PATENT DOCUMENTS

2002/0057955	A1 *	5/2002	Tsubota	B25J 9/042	414/1
2002/0161481	A1 *	10/2002	Uratani	B25J 9/042	700/245
2002/0164929	A1 *	11/2002	Pinson, II	H01L 21/67161	451/41
2003/0017044	A1 *	1/2003	Cameron	H01L 21/67259	414/811
2003/0031538	A1 *	2/2003	Weaver	H01L 21/67766	414/217.1
2003/0062858	A1 *	4/2003	Shimizu	B25J 9/1615	318/34
2003/0070502	A1 *	4/2003	Brett	B25J 9/046	74/490.01
2004/0001750	A1 *	1/2004	Kremerman	B25J 9/042	414/744.1
2004/0012363	A1 *	1/2004	Simondet	B25J 9/1692	318/568.21
2005/0011294	A1 *	1/2005	Hashimoto	B25J 9/042	74/490.01
2005/0036877	A1 *	2/2005	Ogawa	B25J 9/042	414/744.2
2005/0183533	A1 *	8/2005	Tillmann	B25J 9/1015	74/490.03
2006/0219042	A1 *	10/2006	Tu	H01L 21/67766	74/490.01
2007/0110554	A1 *	5/2007	Ono	B25J 9/1025	414/744.5
2008/0152465	A1 *	6/2008	Tachibana	B25J 9/1045	414/222.01
2010/0290886	A1 *	11/2010	Hashimoto	B25J 9/042	414/800
2011/0252912	A1 *	10/2011	Nakagiri	B25J 9/1692	74/490.01
2012/0201641	A1	8/2012	Matsuzaki et al.			
2013/0202390	A1 *	8/2013	Yazawa	B25J 9/043	414/222.09
2014/0216334	A1 *	8/2014	D'Andreta	B25J 19/0075	118/504
2016/0046020	A1 *	2/2016	Chuo	B25J 9/1615	74/490.02
2016/0136818	A1 *	5/2016	Kitahara	B65G 47/90	414/222.07
2017/0182658	A1 *	6/2017	Bordegnoni	B25J 9/042	
2018/0056463	A1	3/2018	Yamada			
2019/0358825	A1 *	11/2019	Imai	B25J 9/1602	

* cited by examiner

FIG. 1

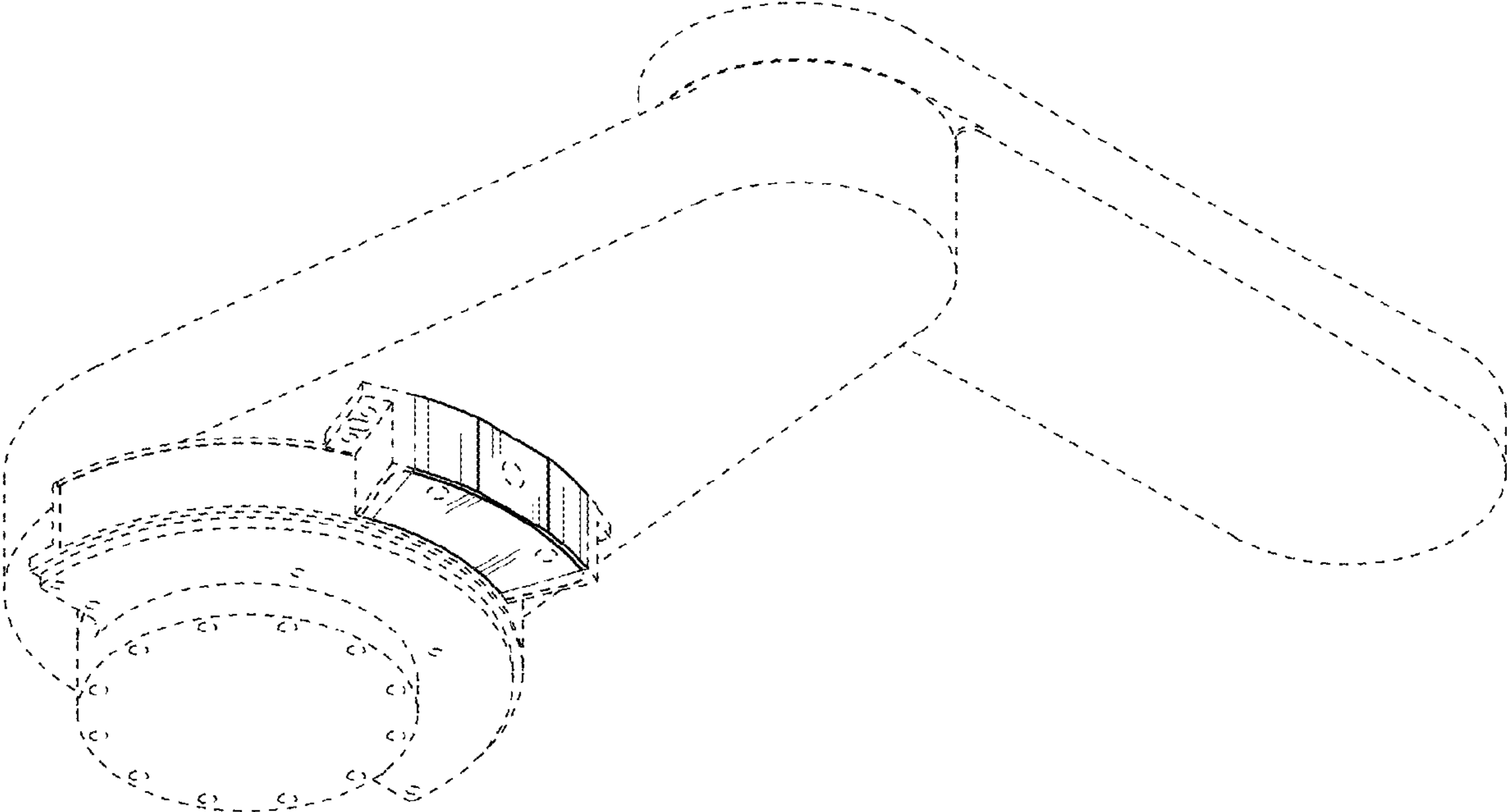

FIG. 2

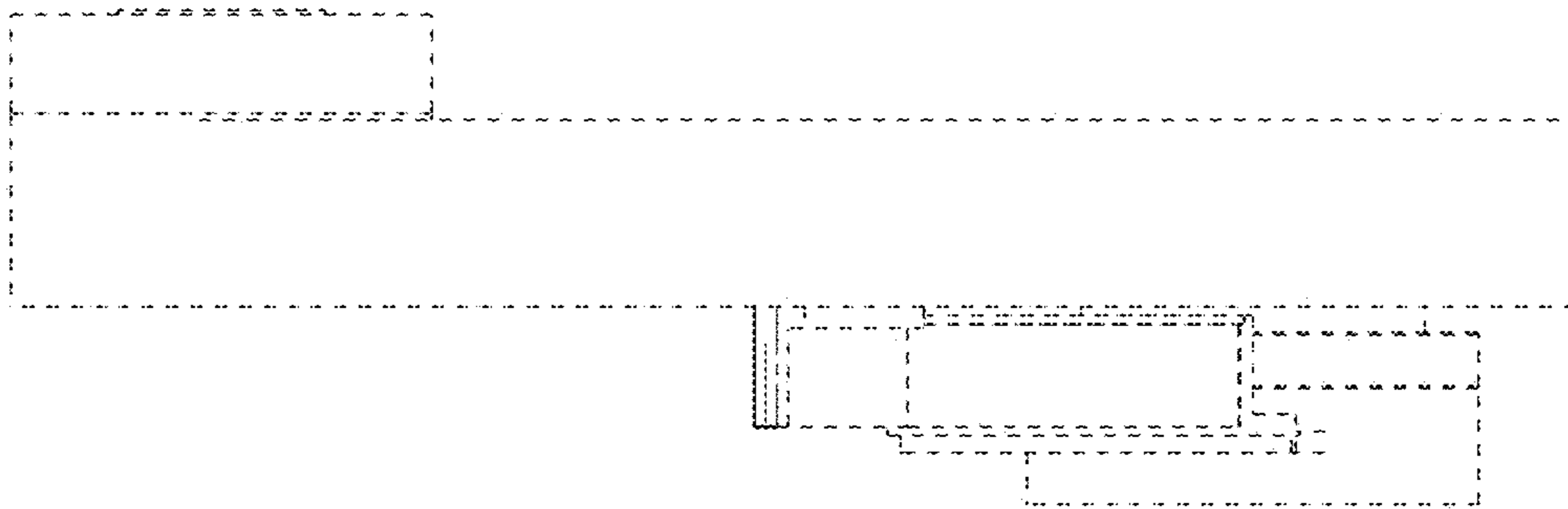

FIG. 3

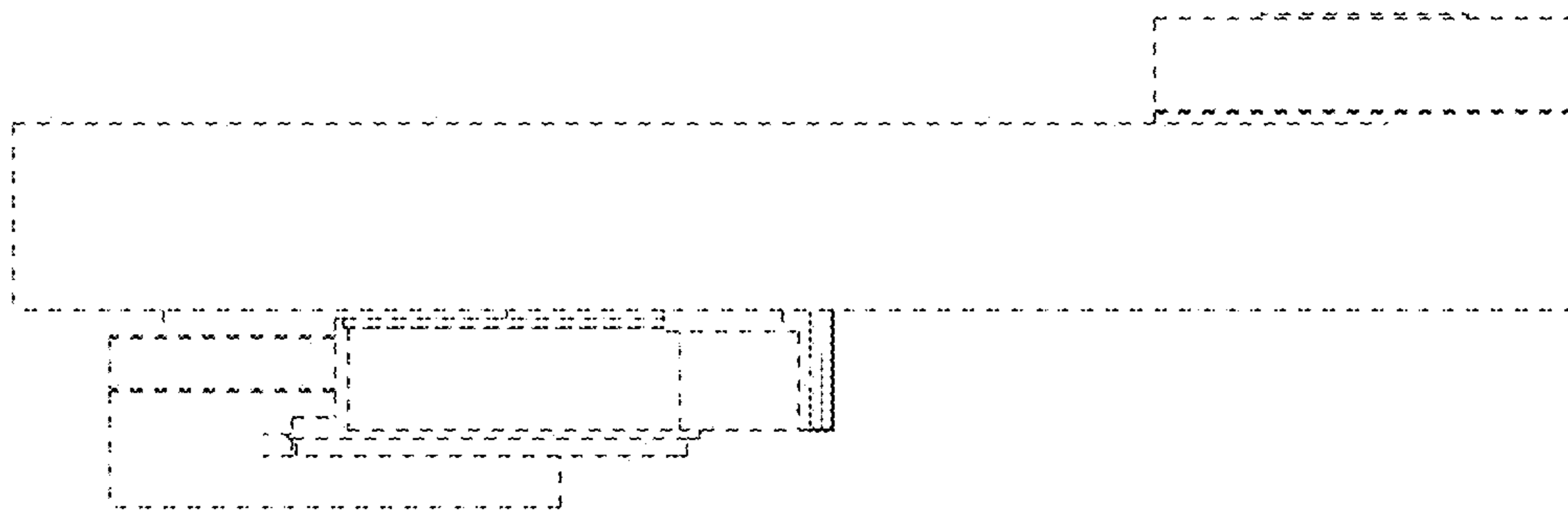

FIG. 4

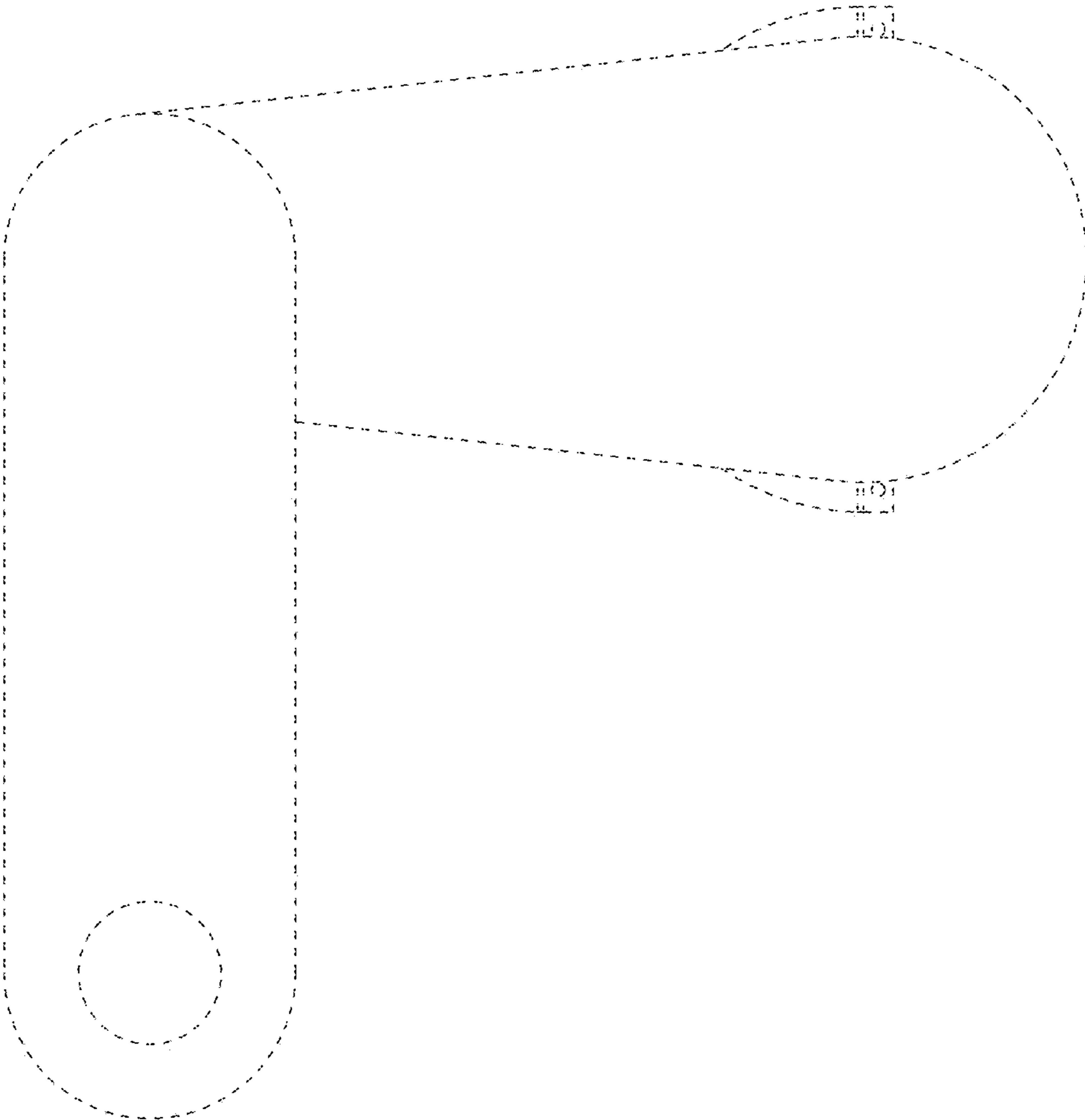

FIG. 5

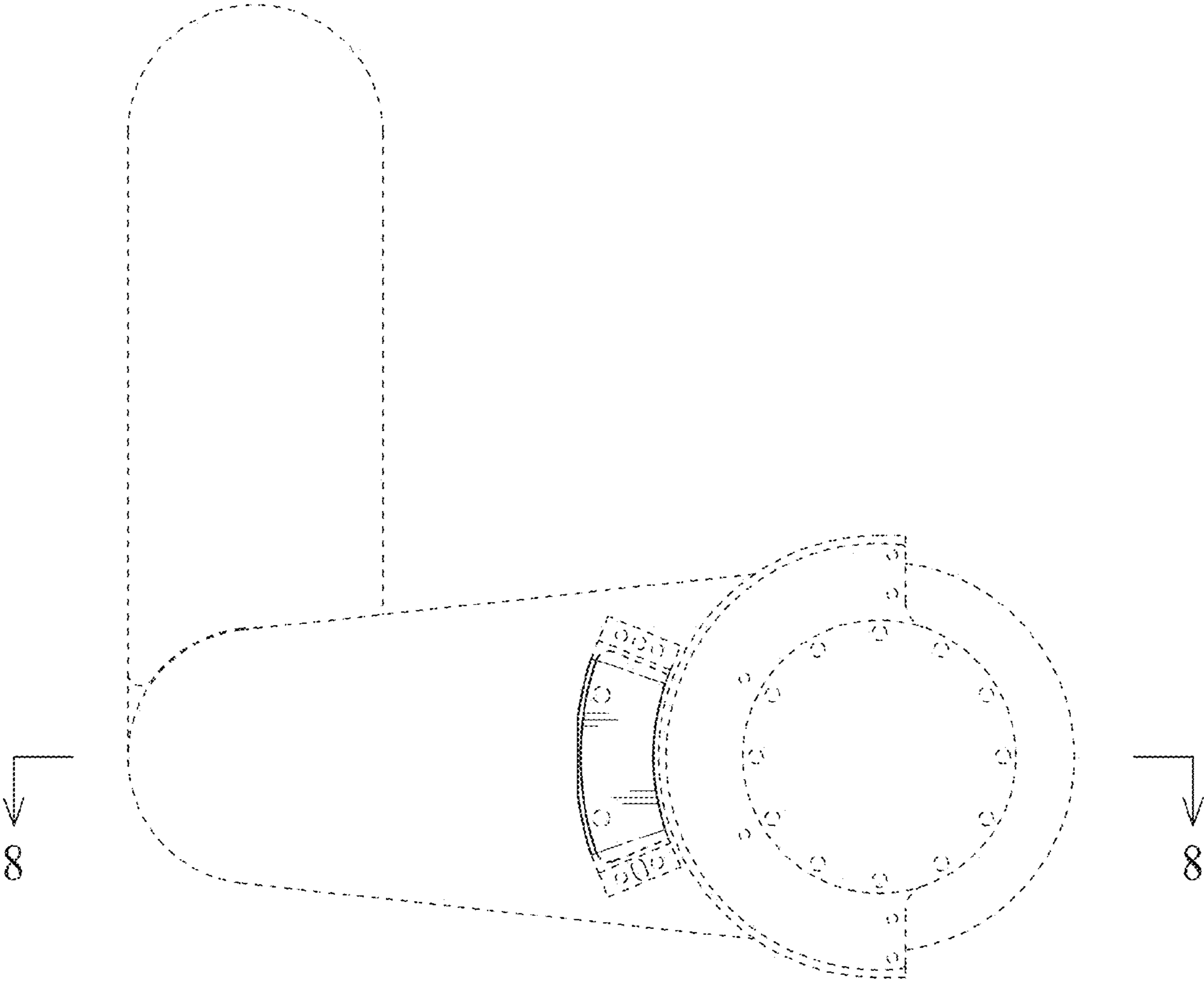

FIG. 6

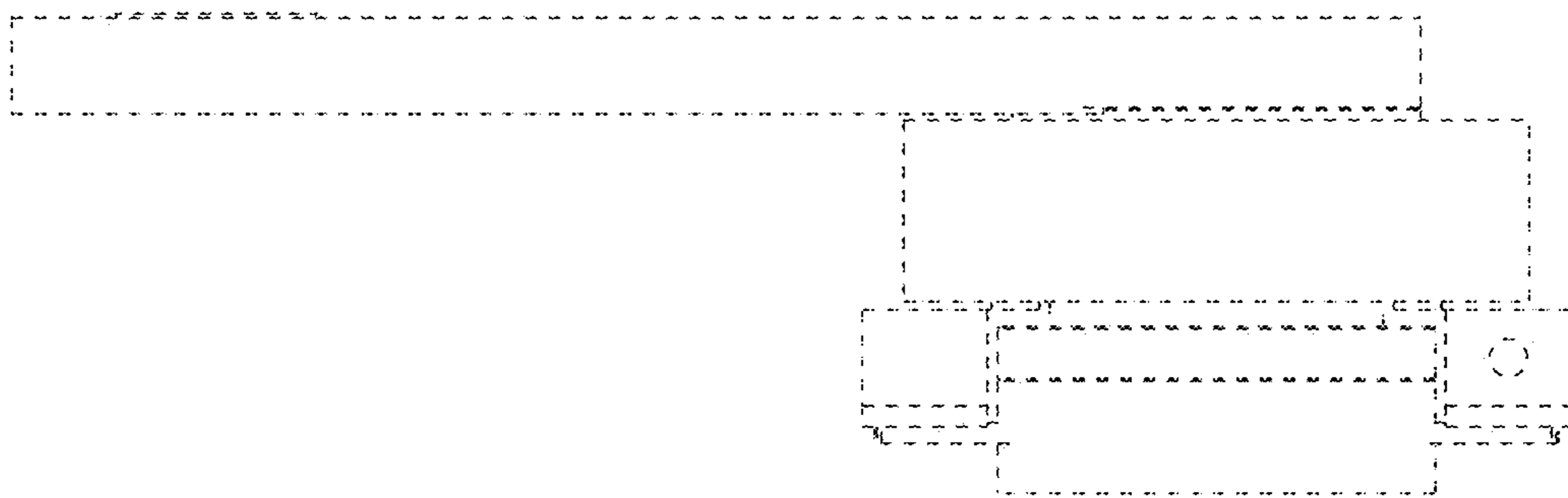

FIG. 7

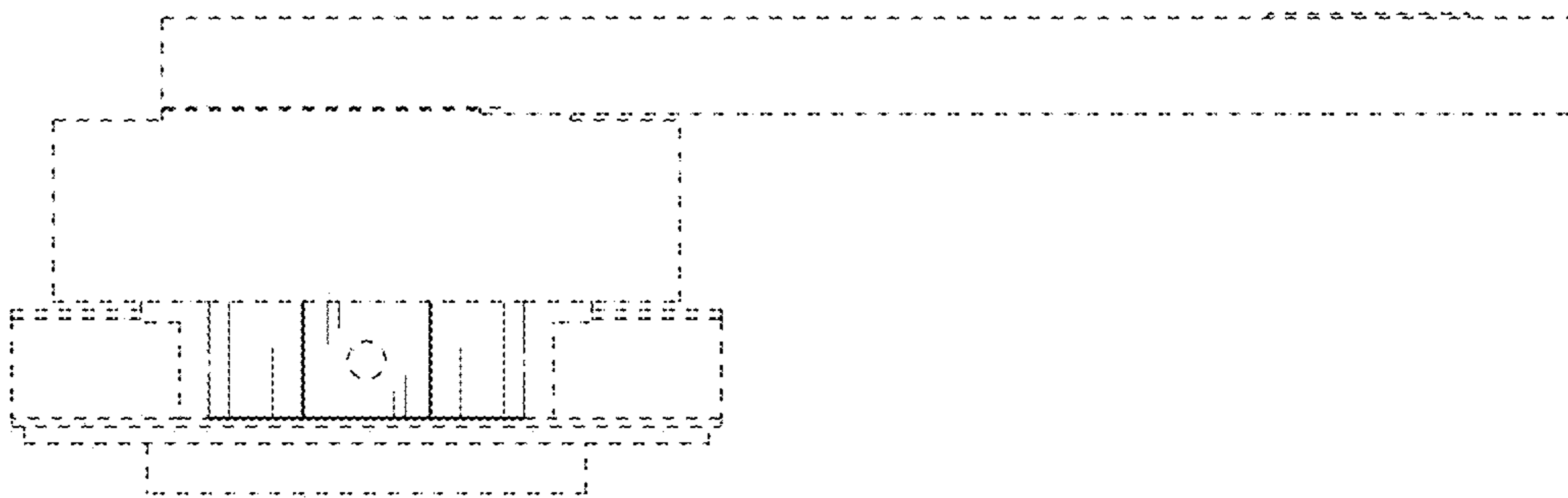

FIG. 8

