



US00D892811S

(12) **United States Design Patent** (10) **Patent No.:** **US D892,811 S**
Suzuki (45) **Date of Patent:** **** Aug. 11, 2020**

(54) **CASSETTE FOR A DIGITAL SLIDE SCANNER**
(71) Applicant: **HAMAMATSU PHOTONICS K.K.**,
Hamamatsu-shi, Shizuoka (JP)
(72) Inventor: **Yasumoto Suzuki**, Hamamatsu (JP)
(73) Assignee: **HAMAMATSU PHOTONICS K.K.**,
Hamamatsu-shi, Shizuoka (JP)
(**) Term: **15 Years**

Primary Examiner — Susan Moon Lee
(74) *Attorney, Agent, or Firm* — Faegre Drinker Biddle & Reath LLP

(21) Appl. No.: **29/621,873**
(22) Filed: **Oct. 12, 2017**
(30) **Foreign Application Priority Data**

(57) **CLAIM**
The ornamental design for a cassette for a digital slide scanner, as shown and described.

Apr. 13, 2017 (JP) 2017-007961
(51) **LOC (12) Cl.** **14-02**
(52) **U.S. Cl.**
USPC **D14/453**
(58) **Field of Classification Search**
USPC 5/417, 419-420, 465, 632-634; 108/43;
248/118, 118.1, 118.3, 118.5, 205.2, 346,
248/346.01, 346.07, 346.1, 438, 633, 918;
273/338, 438, DIG. 30; 297/218.1,
297/228.12, 352, 377, 440.1, 440.11,
297/440.15, 452.1, 452.16;
312/208.1-208.4, 223.2, 322; 340/710;
345/163, 173; 360/69, 97.02;
361/679.33-679.45, 737, 752, 736, 728,
361/796, 797, 729, 730, 725-727, 801,
361/798; 400/412, 713-715;
(Continued)

DESCRIPTION

FIG. 1 is a front view of a cassette for a digital slide scanner of the present invention.
FIG. 2 is a rear view thereof.
FIG. 3 is a top plan view thereof.
FIG. 4 is a bottom view thereof.
FIG. 5 is a right side view thereof.
FIG. 6 is a left side view thereof.
FIG. 7 is a perspective view thereof.
FIG. 8 is an enlarged view showing a portion of FIG. 1 defined by the line 8-8.
FIG. 9 is an enlarged top plan view.
FIG. 10 is an enlarged view showing a portion of FIG. 5 defined by the line 10-10.
FIG. 11 is an enlarged view showing a portion of FIG. 6 defined by the line 11-11.
FIG. 12 is an enlarged view showing a portion of FIG. 7 defined by the line 12-12.
FIG. 13 is an enlarged cross-sectional view taken along the line 13-13 in FIG. 8.
FIG. 14 is an enlarged cross-sectional view taken along the line 14-14 in FIG. 10; and,
FIG. 15 is an enlarged cross-sectional view taken along the line 15-15 in FIG. 11.

(56) **References Cited**
U.S. PATENT DOCUMENTS
4,248,498 A 2/1981 Georges
D275,553 S 9/1984 Emmie et al.
(Continued)

The features shown in broken lines depict environmental subject matter only and form no part of the claimed design. The alternating long and short dashed lines indicate bounds of the claimed design and form no part thereof.

1 Claim, 15 Drawing Sheets

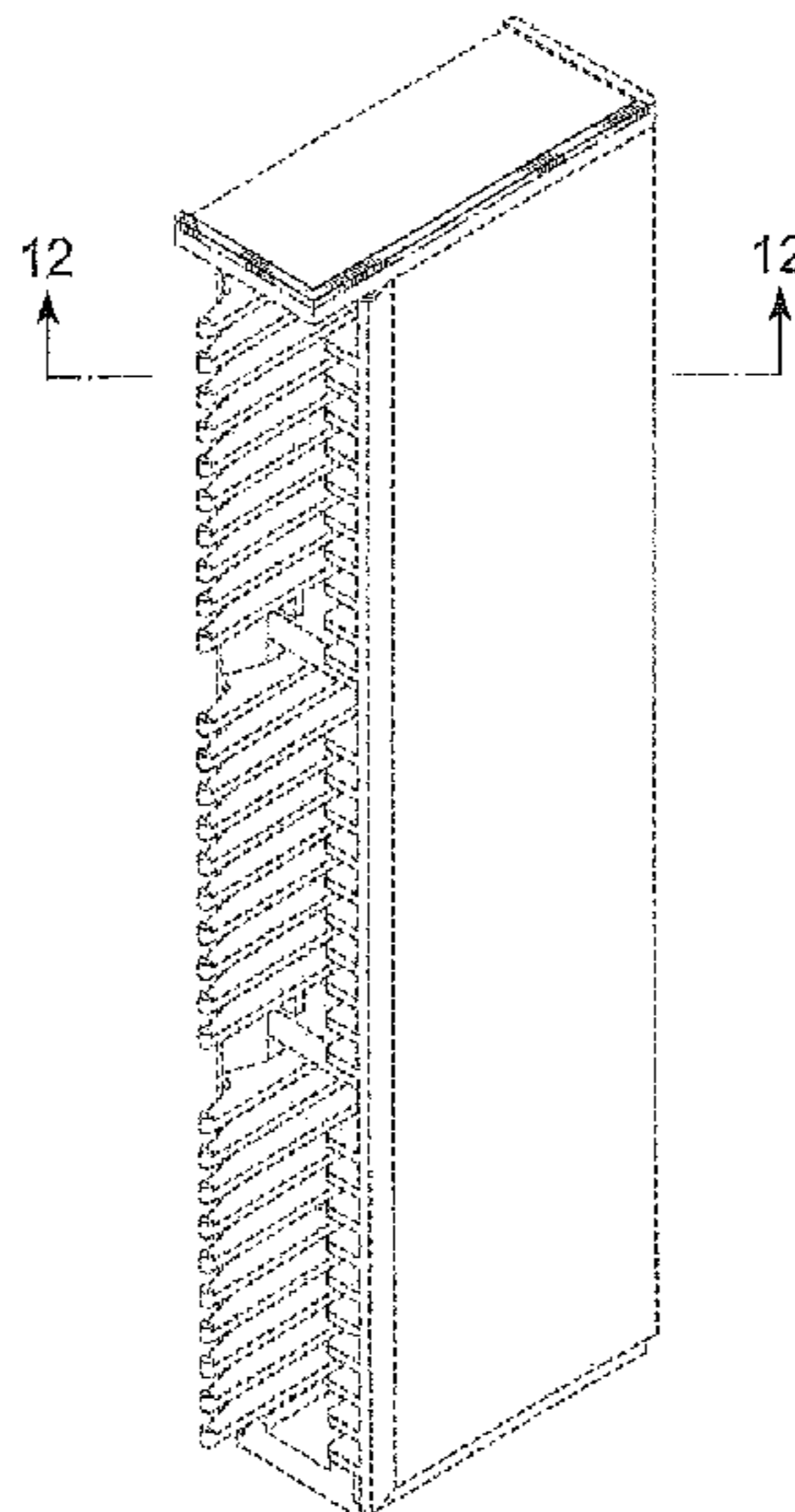

(58) **Field of Classification Search**

USPC 428/137-138, 140, 304.4, 457; 442/9;
 D3/273; D6/201, 204, 429-431, 449,
 D6/474, 509-510; D9/432; D10/65, 75,
 D10/78; D13/103, 119, 162, 184, 199;
 D14/110, 114, 125, 240, 242, 299-302,
 D14/314, 348-370, 435-438, 496,
 D14/478-480, 432, 453; D18/1, 7, 9, 11;
 235/441, 443, 487, 492, 493, 495, 380,
 235/382, 382.5, 375, 494; 257/678, 679,
 257/693, E23.064; 439/946, 948, 159,
 439/352, 157, 298, 328, 377, 64;
 174/250, 260, 52.1, 52.2; 710/300-303;
 438/121; 348/79, 80; D8/354;
 403/322.1, 322.4; 353/103, 104, 108-118
 CPC G06K 19/06196; G06K 19/072; G06K
 19/0721; G06K 19/0722; G06K 19/0723;
 G06K 19/0724; G06K 19/0725; G06K
 19/0726; G06K 19/0727; G06K 19/0728;
 G06K 19/073; G06K 19/07309; G06K
 19/077; G06K 19/07701; G06K
 19/07715; G06K 19/0772; G06K
 19/07724; G06K 19/07726; G06K
 19/07728; G06K 19/06037-06206; G06K
 19/067; G06K 2019/06262; G06K
 7/1417-1495; G06F 21/86; G06F 21/87;
 G06F 21/88; G06F 21/77-80; G06F
 21/85-88; G06F 21/00; G06F 1/186-188;
 G06Q 20/3229; G06Q 20/34; G06Q
 20/341; G06Q 20/346; G06Q 20/349;
 G06Q 20/3563; G06Q 20/3567; G06Q
 20/357; G06Q 20/3576; G06Q 20/3276;
 H05K 5/026; H05K 5/0256; H05K
 5/0265; H05K 5/0269; H05K 5/0273;
 H05K 5/0278; H05K 5/0282; H05K
 5/0286; H05K 5/0291; H05K 5/0295;
 H05K 5/03; H05K 5/04; H05K 5/06;
 H05K 5/061; H05K 5/062; H05K 5/063;
 H05K 5/064; H05K 5/065; H05K 5/066;
 H05K 5/067; H05K 5/068; H05K 5/069;
 H05K 7/00; H05K 7/005; H05K 7/02;
 H05K 7/023; H05K 7/026; H05K 7/04;
 H05K 7/10; H05K 7/1418; H05K 7/142;
 H05K 7/1424; H05K 7/1427-1439; H05K
 7/1461; H05K 7/1464-1474; H05K
 7/1479; H05K 7/1481; H05K
 7/1485-1488; H05K 2201/09745; H05K
 2201/09754; H05K 2201/09763; H05K
 2201/09772; H05K 2201/098; H05K
 2201/09818; H05K 2201/10; H05K
 2201/10007; H05K 7/1411; H05K
 7/1409; H05K 7/1417; H05K
 7/1421-1454; H04N 2201/216; G07C
 9/00722; G07C 9/00571; G07C 9/00904;
 G07C 9/00103; G03B 23/00; G03B
 23/048; G02B 21/365; G02B 21/367;
 G02B 21/002; Y10T 403/591; Y10T
 403/595; Y10T 74/18944; Y10T 74/1896;
 H01R 13/62933; H01R 13/62944; H01R
 13/6295; H01R 13/62955; H01R
 13/62961; H01R 13/62983; H01R 12/70;
 H01R 12/7005; H01R 12/7011

See application file for complete search history.

(56)

References Cited

U.S. PATENT DOCUMENTS

D303,988 S 10/1989 Buchweitz, Jr. et al.
 D310,520 S 9/1990 Bedard
 D310,823 S 9/1990 Chabala et al.
 D311,391 S * 10/1990 Ueshin D14/438
 D312,205 S 11/1990 de Rooij
 D315,720 S 3/1991 Freehauf
 D325,573 S * 4/1992 Glegg D14/438
 D326,447 S * 5/1992 Hofland D14/438
 5,136,864 A 8/1992 Spiekermann et al.
 D348,258 S * 6/1994 Giompaolo D14/438
 D376,135 S * 12/1996 Sharp D14/438
 5,726,435 A 3/1998 Hara et al.
 D393,459 S * 4/1998 Barbeau D14/438
 5,845,978 A * 12/1998 Jung G06F 1/181
 312/244
 D414,165 S 9/1999 Klein
 D464,354 S * 10/2002 Small D14/435
 D468,743 S * 1/2003 Kawanobe D14/435
 D494,975 S * 8/2004 McClelland, II D14/435
 6,878,006 B1 4/2005 Heidenreich et al.
 6,912,124 B2 6/2005 Megason et al.
 D509,219 S * 9/2005 Avery D14/435
 6,948,961 B2 9/2005 Oguchi
 6,992,900 B1 1/2006 Suzue et al.
 D520,015 S * 5/2006 Peddle D14/435
 7,140,738 B2 11/2006 Guiney et al.
 D543,206 S * 5/2007 Maruyama D14/435
 D544,866 S * 6/2007 Wang D14/438
 D555,653 S * 11/2007 Tseng D14/435
 7,295,447 B2 11/2007 Strmiska et al.
 7,300,163 B2 11/2007 Scampini
 7,301,778 B1 11/2007 Fang
 D578,127 S 10/2008 Crisp et al.
 D579,940 S * 11/2008 Pepin D14/435
 D588,132 S * 3/2009 Lauffer D14/432
 7,571,864 B2 8/2009 Kiliccote
 D600,698 S * 9/2009 Kramer D14/432
 D611,049 S * 3/2010 Kramer D14/432
 7,753,457 B2 7/2010 Wood
 7,859,667 B2 12/2010 Scampini
 8,098,956 B2 1/2012 Tatke et al.
 D656,391 S 3/2012 McClain et al.
 D659,133 S * 5/2012 Crisp D14/301
 D664,544 S * 7/2012 Yi D14/436
 D673,956 S 1/2013 Yokoyama
 D686,623 S 7/2013 Bennett, Jr. et al.
 8,573,499 B1 11/2013 Boyle
 8,593,827 B1 11/2013 Lewis et al.
 8,625,930 B2 1/2014 Tatke et al.
 8,675,992 B2 3/2014 Dietz et al.
 D702,646 S 4/2014 Uebayashi et al.
 8,744,213 B2 6/2014 Tatke et al.
 D711,387 S * 8/2014 Kuehn D14/435
 8,797,396 B2 8/2014 Dietz et al.
 8,985,443 B1 3/2015 Boyle
 D729,250 S * 5/2015 Han D14/436
 D740,817 S 10/2015 Ignomirello
 9,300,658 B1 3/2016 Sadacharam et al.
 D755,182 S 5/2016 Bassett et al.
 9,576,172 B2 2/2017 Huang et al.
 D794,643 S * 8/2017 Bang D14/435
 D794,644 S * 8/2017 Bang D14/435
 D795,262 S * 8/2017 Bang D14/435
 9,776,322 B2 10/2017 Nilsson et al.
 D804,484 S * 12/2017 Kim D14/435
 D808,970 S 1/2018 Gessford et al.
 D828,357 S * 9/2018 Lim D14/436
 D830,363 S 10/2018 Helms et al.
 D830,974 S 10/2018 Kufner et al.
 D839,271 S 1/2019 King-Murrey et al.
 10,178,807 B2 * 1/2019 Conn H05K 7/1485
 D842,304 S * 3/2019 Depay D14/435
 D848,434 S * 5/2019 Toyoda D14/436
 D855,617 S * 8/2019 Williams D14/436
 D857,021 S * 8/2019 Ohta D14/435

(56)

References Cited

U.S. PATENT DOCUMENTS

D860,140 S 9/2019 Wu
 D862,475 S * 10/2019 Lim D14/436
 D863,311 S * 10/2019 Depay D14/435
 D866,555 S * 11/2019 Suzuki D14/432
 D868,069 S * 11/2019 Hung D14/435
 D868,787 S * 12/2019 Magi D14/436
 D869,470 S * 12/2019 Lim D14/436
 D872,699 S 1/2020 Chen
 D876,443 S * 2/2020 Morgan D14/436
 2005/0142940 A1 6/2005 Manine
 2006/0109432 A1 5/2006 Guiney et al.
 2008/0002853 A1 1/2008 Kawabe et al.
 2008/0013272 A1 1/2008 Bailey et al.
 2008/0121688 A1 5/2008 Harrop
 2008/0240613 A1 10/2008 Dietz et al.
 2008/0301464 A1 12/2008 Parkinson
 2009/0043783 A1 2/2009 Wakasa et al.
 2009/0057420 A1 3/2009 Onoda et al.
 2009/0108057 A1 4/2009 Mu et al.
 2009/0255992 A1 10/2009 Shen
 2011/0043858 A1 2/2011 Jetter
 2012/0027325 A1 2/2012 Lacarra
 2012/0104105 A1 5/2012 Nemet et al.
 2012/0197660 A1 8/2012 Prodanovich
 2012/0209688 A1 8/2012 Lamothe et al.
 2012/0267440 A1 10/2012 Nakaya et al.
 2012/0323699 A1 12/2012 Phillips
 2013/0026241 A1 1/2013 Sakahashi et al.
 2013/0043302 A1 2/2013 Powlen et al.
 2013/0087609 A1 4/2013 Nichol et al.
 2013/0126598 A1 5/2013 Beadles et al.
 2013/0146658 A1 6/2013 Guerra

2013/0166441 A1 6/2013 Kobylkin et al.
 2013/0221114 A1 8/2013 Myers et al.
 2013/0320099 A1 12/2013 Acton et al.
 2013/0341417 A1 12/2013 Argue et al.
 2014/0070012 A1 3/2014 Hunt et al.
 2014/0100973 A1 4/2014 Brown et al.
 2014/0108606 A1 4/2014 Beadles
 2014/0110468 A1 4/2014 Kandregula
 2014/0110486 A1 4/2014 Nemet
 2014/0117100 A1 5/2014 Black et al.
 2014/0117101 A1 5/2014 Cok
 2014/0144996 A1 5/2014 Friedman et al.
 2014/0149285 A1 5/2014 De et al.
 2014/0224888 A1 8/2014 Bomer et al.
 2014/0224889 A1 8/2014 Key
 2014/0263667 A1 9/2014 Mege
 2014/0263674 A1 9/2014 Cerveny
 2014/0263675 A1 9/2014 Beadles
 2014/0281855 A1 9/2014 Bhatnagar
 2015/0008257 A1 1/2015 Beadles
 2015/0161496 A1 6/2015 Rodriguez et al.
 2015/0199601 A1 7/2015 Bienek
 2015/0213734 A1 7/2015 Glickman
 2015/0229603 A1 8/2015 Chor
 2015/0269466 A1 9/2015 Inotay et al.
 2015/0269469 A1 9/2015 Sharma et al.
 2015/0363683 A1 12/2015 Polzoni
 2016/0086072 A1 3/2016 Castillo
 2016/0140428 A1 5/2016 Kamitani et al.
 2016/0155033 A1 6/2016 Nakano et al.
 2016/0180131 A1 6/2016 Seo et al.
 2017/0235977 A1 8/2017 Nadabar et al.
 2018/0025263 A1 1/2018 Toyozumi et al.
 2018/0137323 A1 5/2018 Jiang et al.
 2018/0157813 A1 6/2018 Rodrigs et al.

* cited by examiner

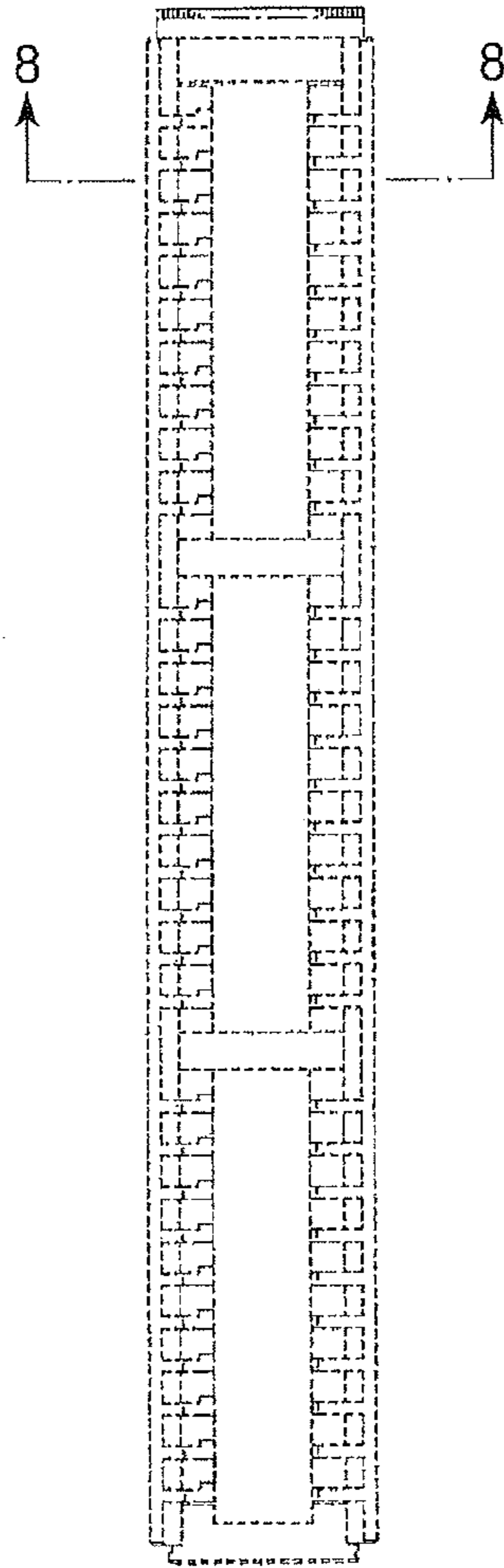

FIG. 1

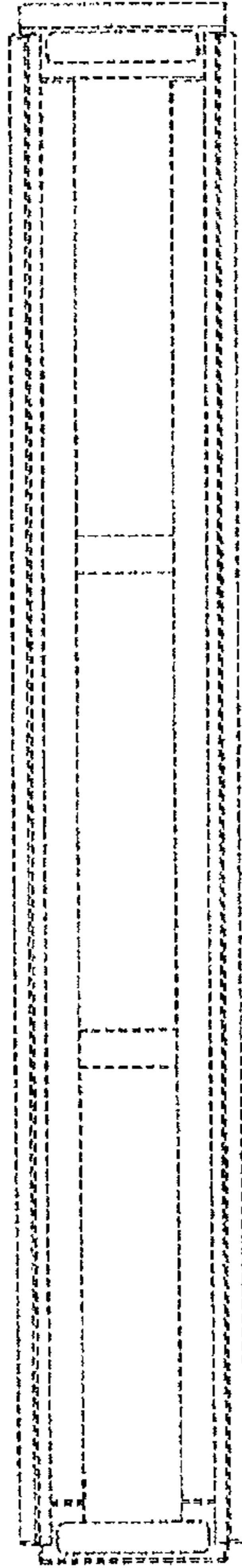

FIG. 2



FIG. 3

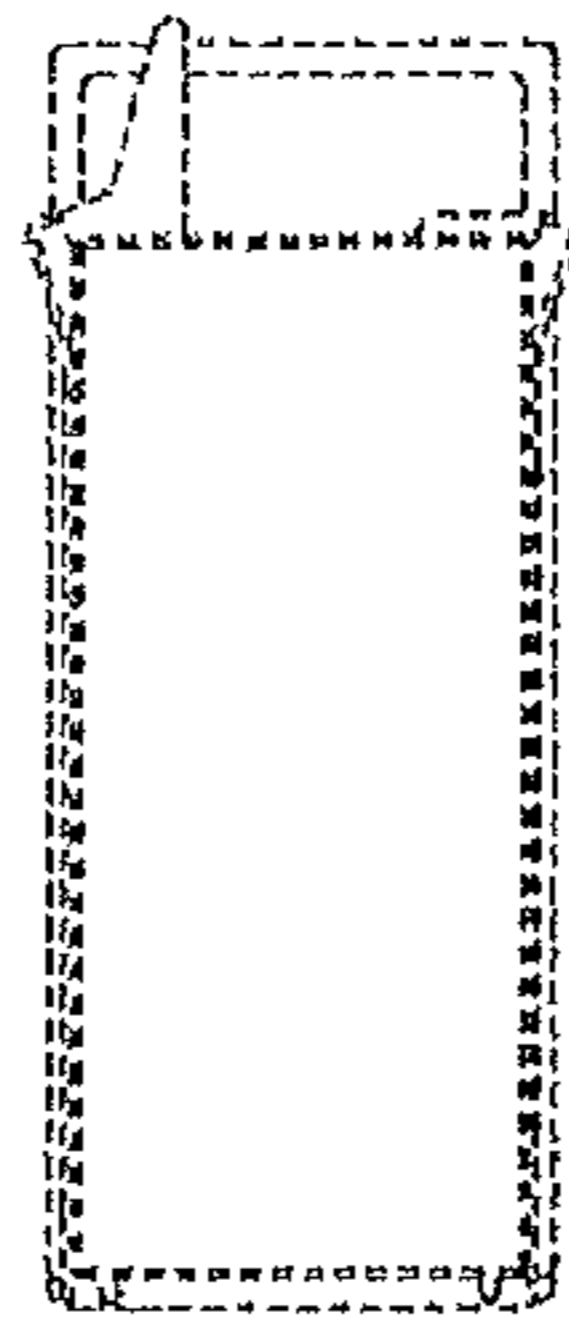

FIG. 4

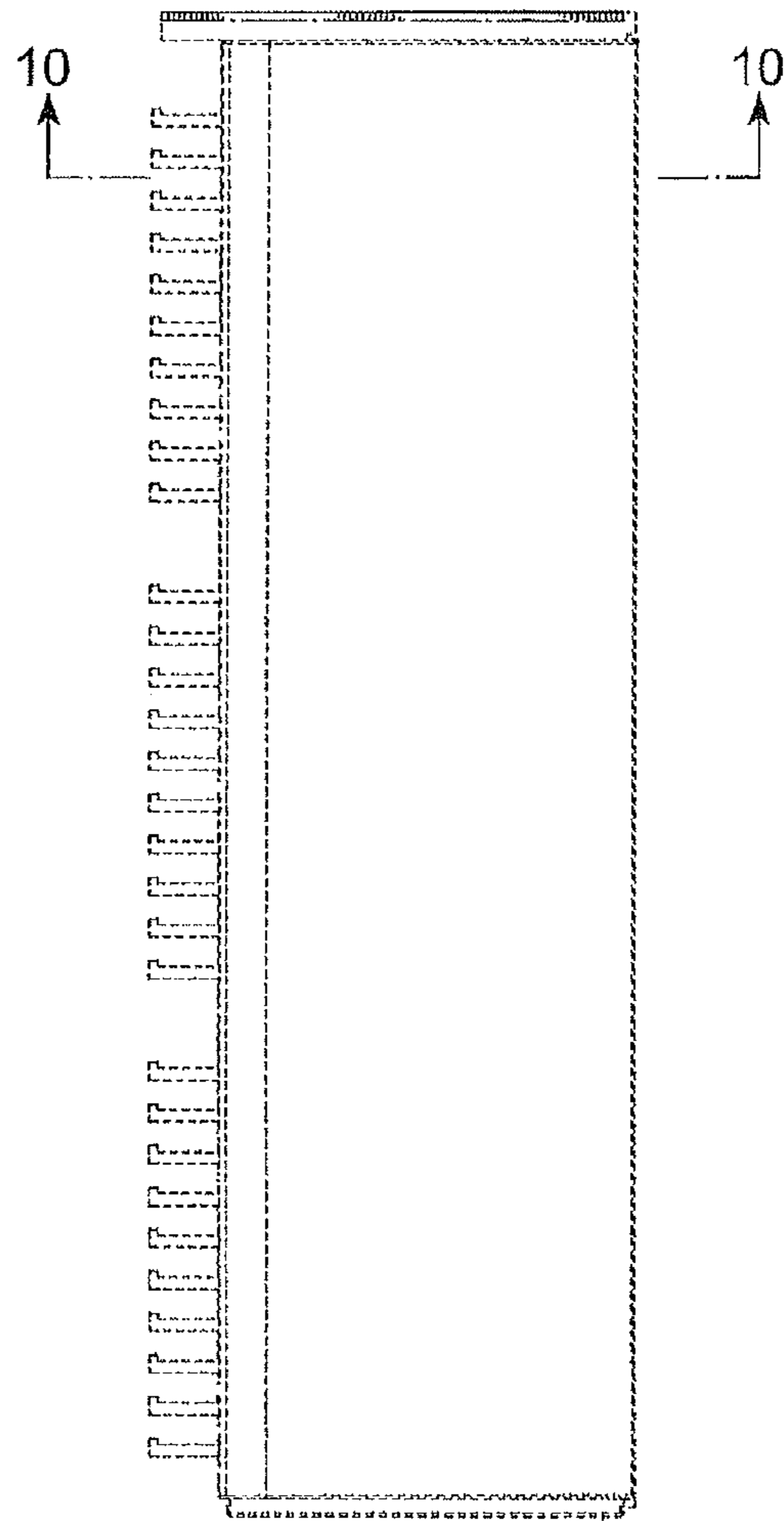

FIG. 5

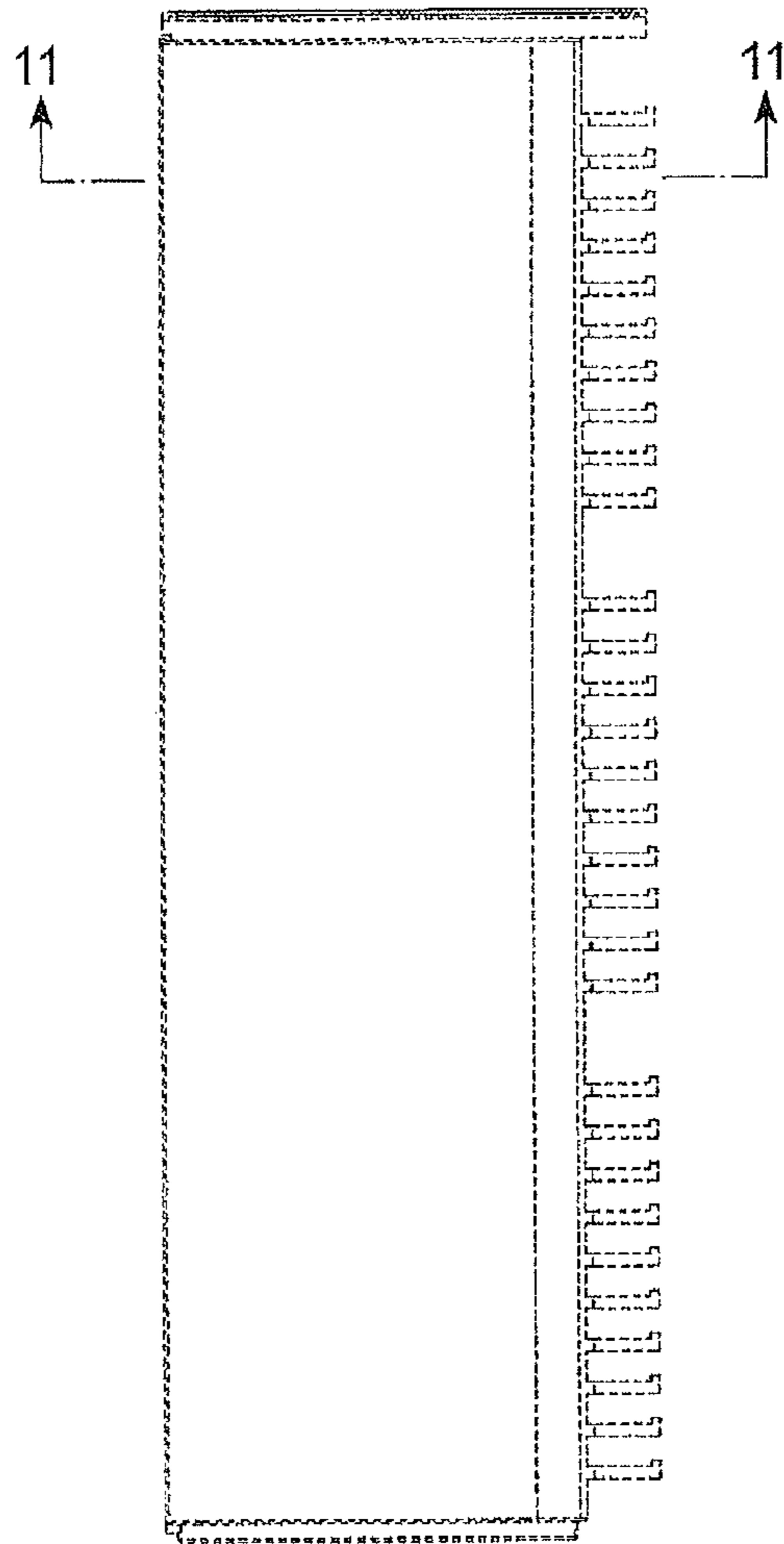

FIG. 6

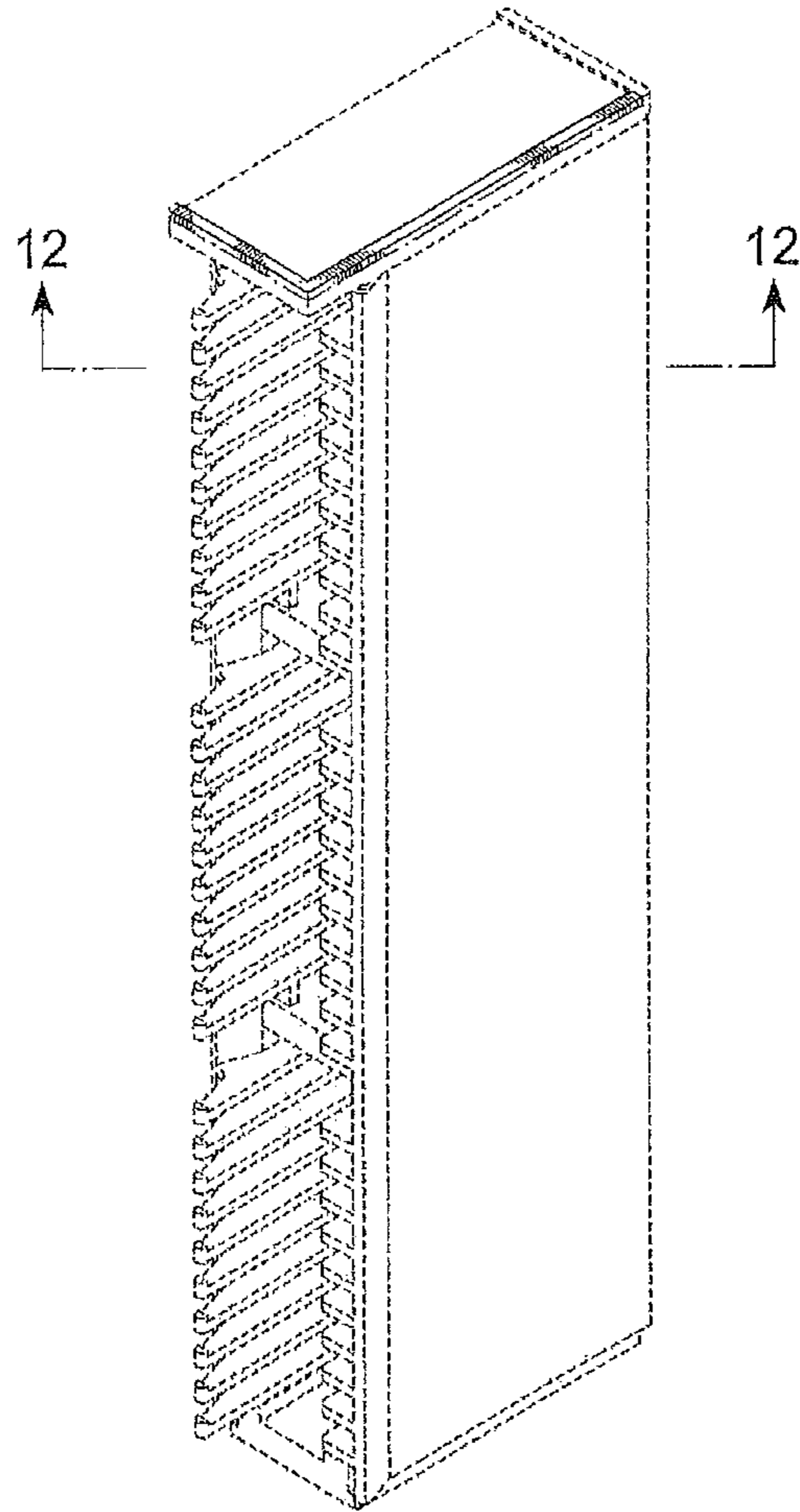

FIG. 7

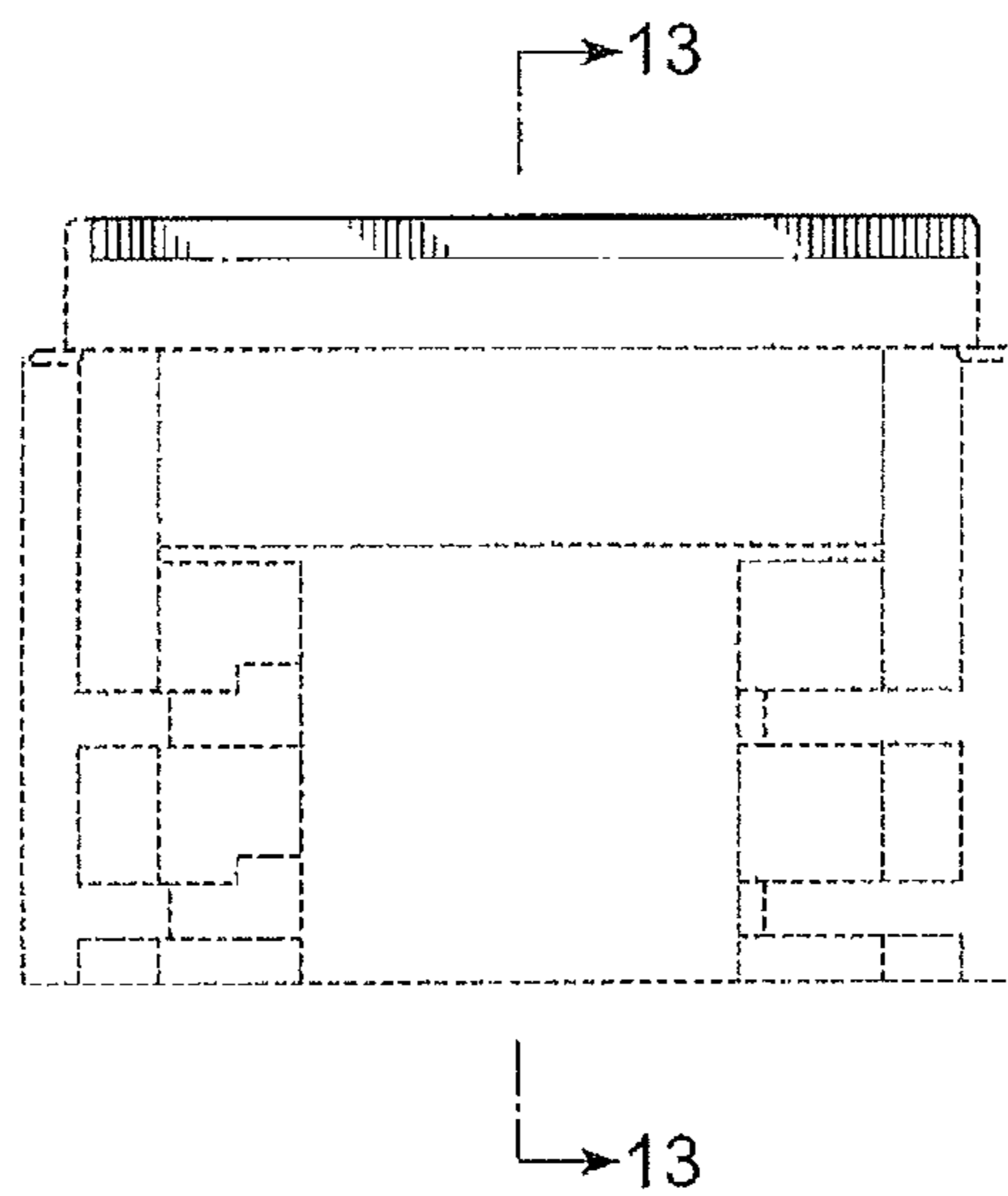

FIG. 8



FIG. 9

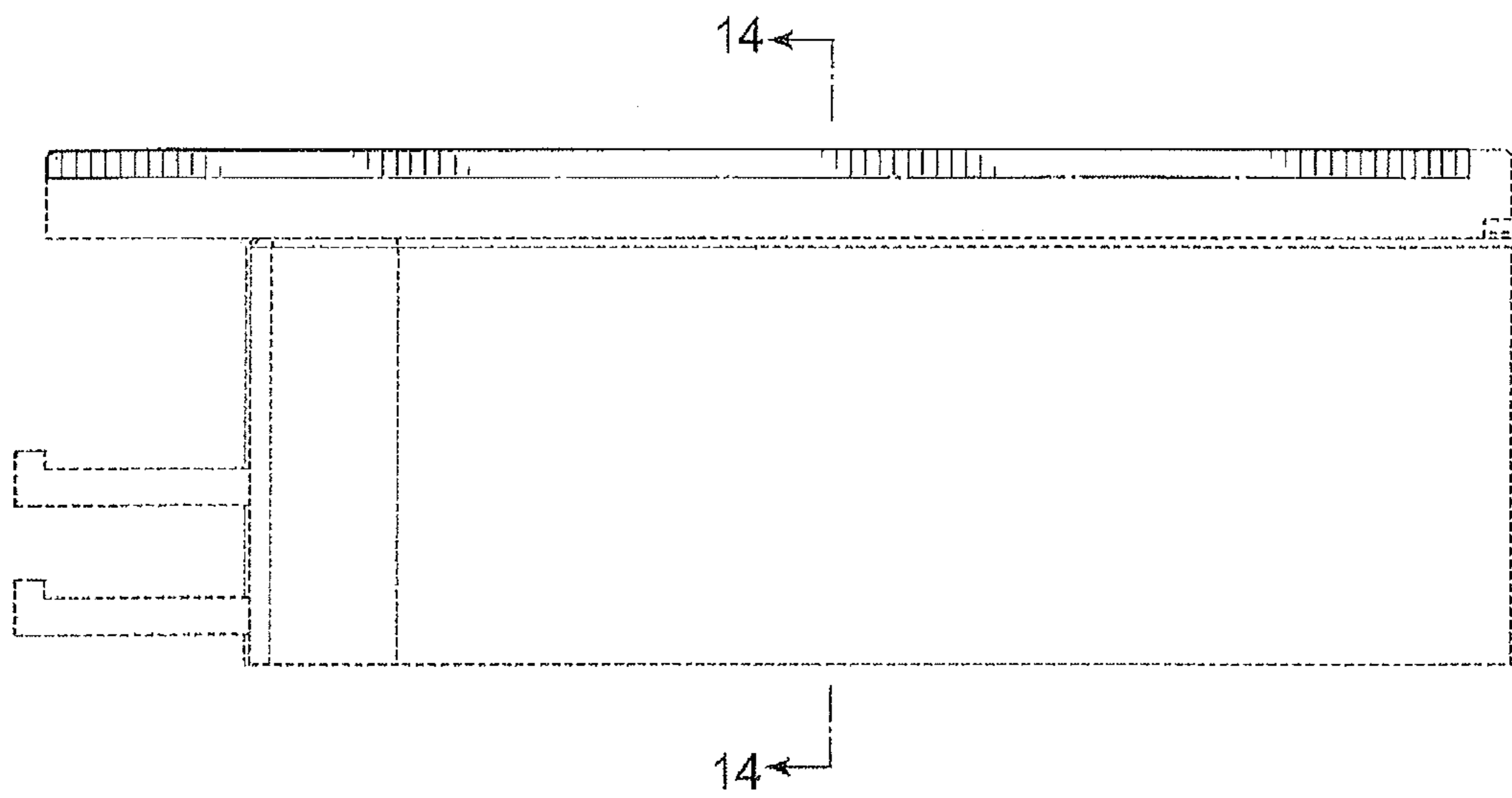

FIG. 10

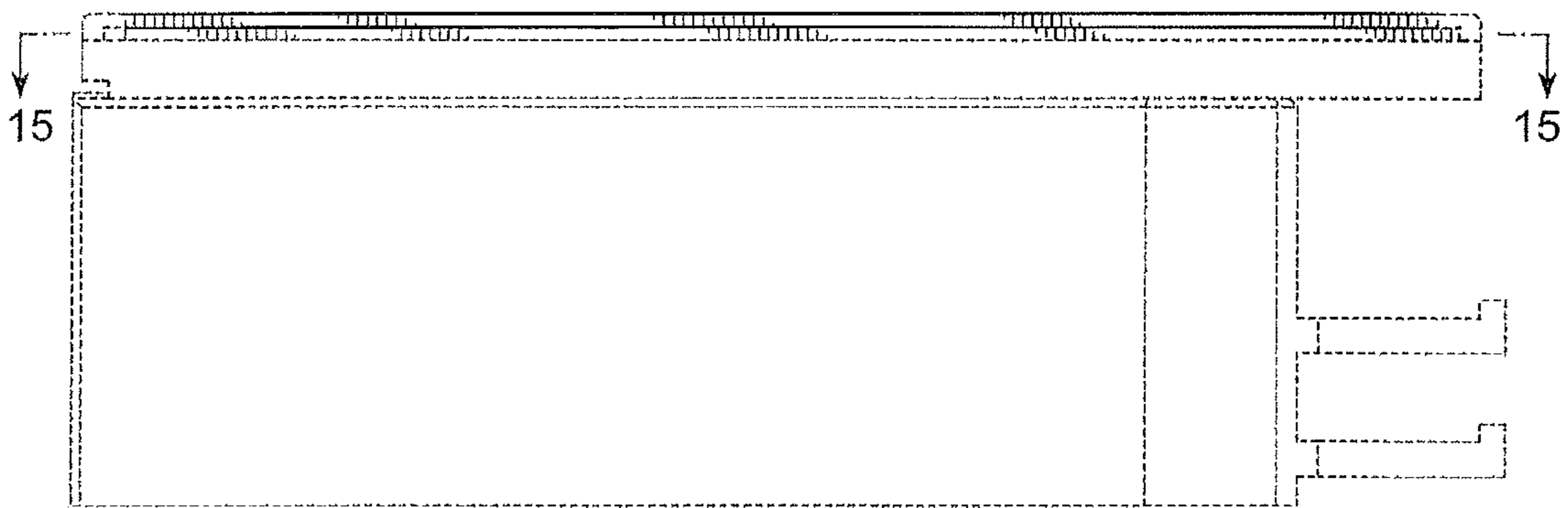

FIG. 11

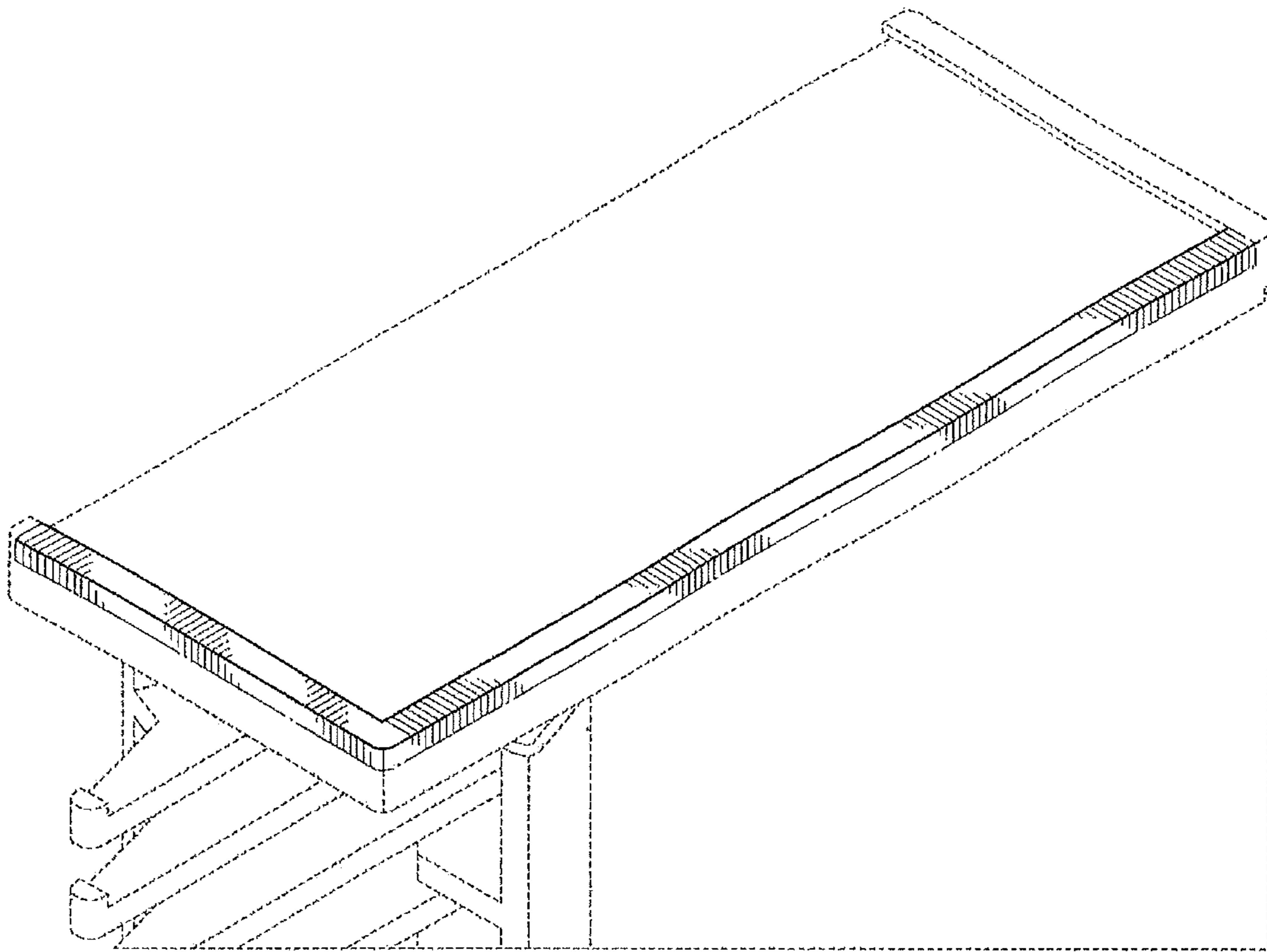

FIG. 12

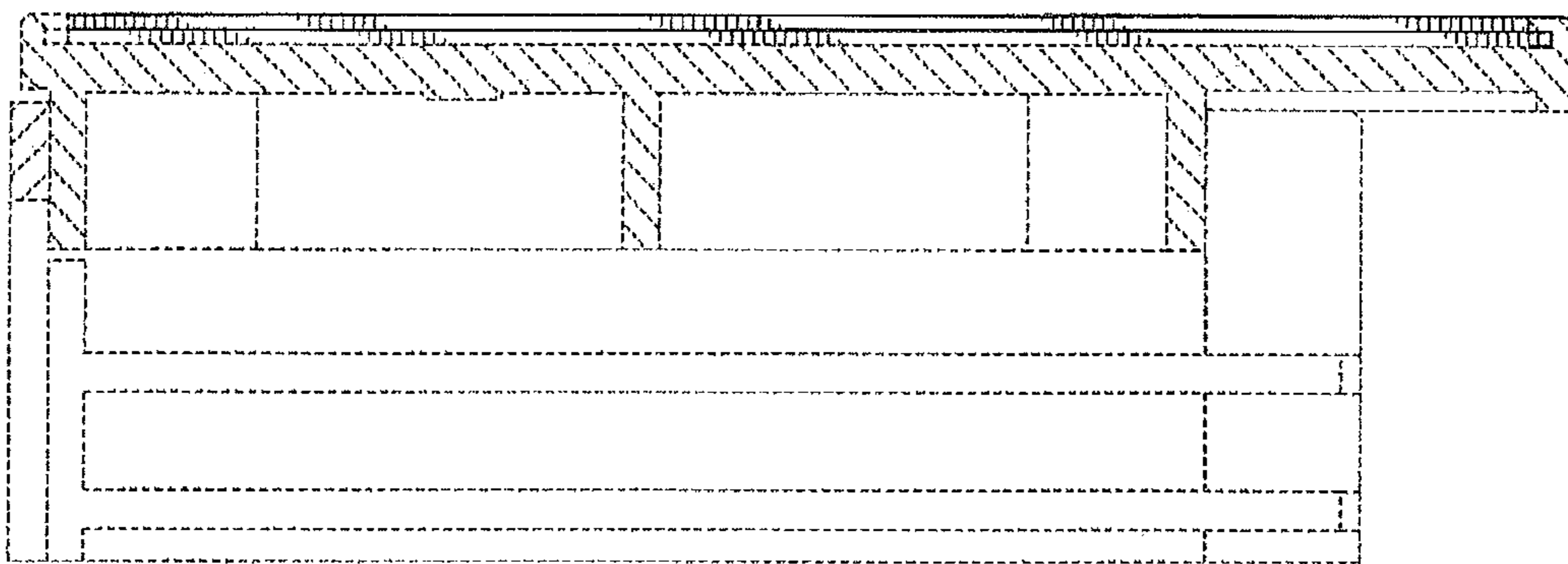

FIG. 13

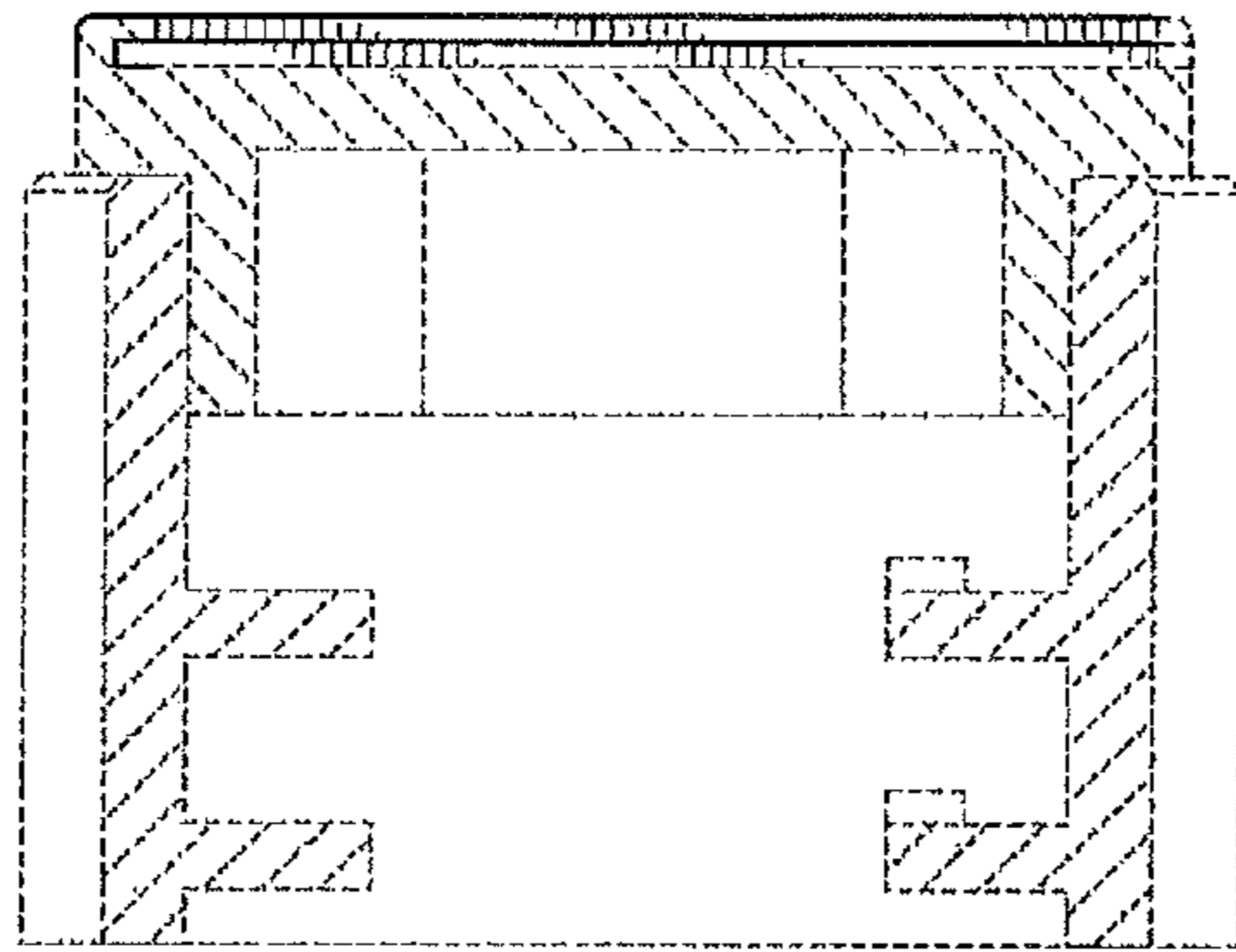

FIG. 14

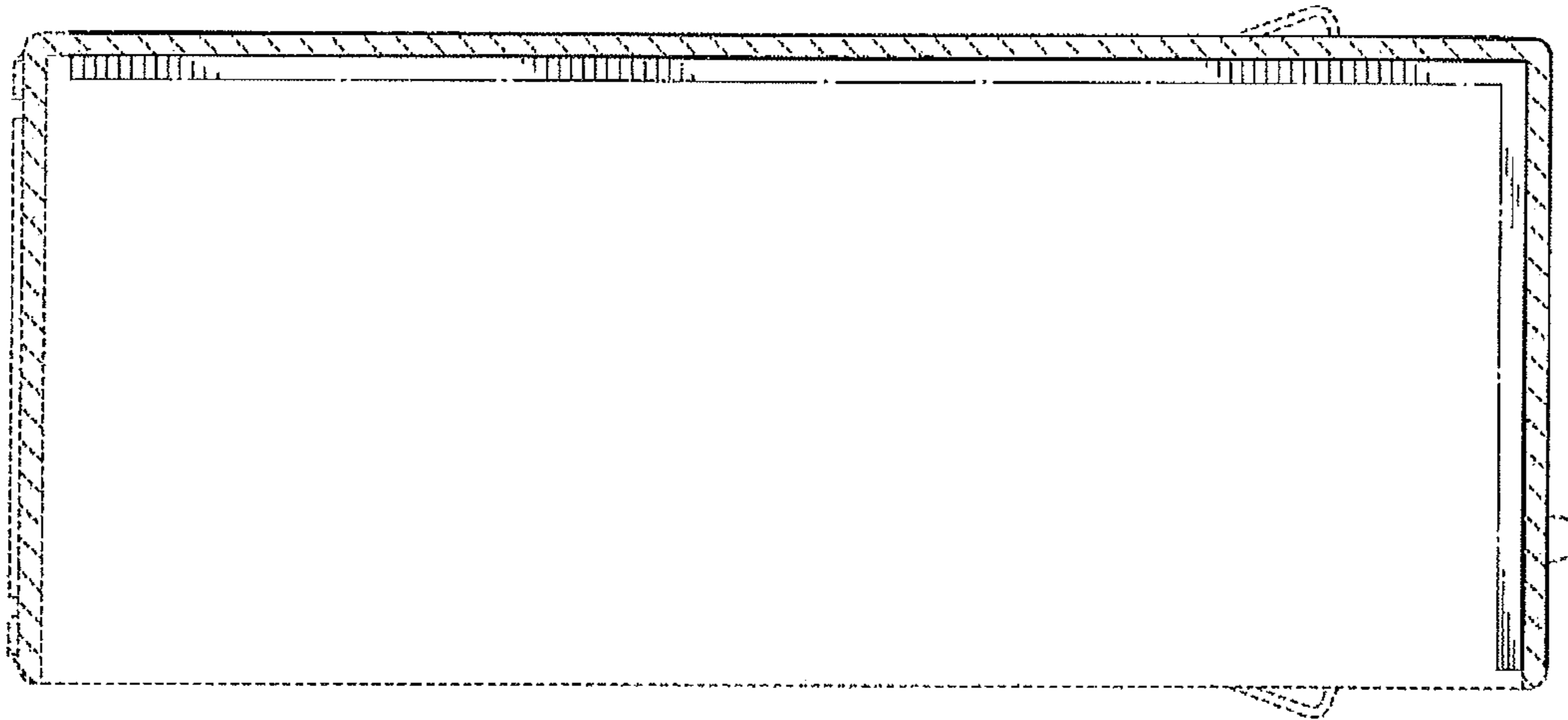

FIG. 15