



US00D892752S

(12) **United States Design Patent**
Sago et al.

(10) **Patent No.:** **US D892,752 S**

(45) **Date of Patent:** **** Aug. 11, 2020**

(54) **POLYMER ACTUATOR**

7/0016; B81B 7/0019; B81B 7/0022;
B81B 7/0025; B81B 7/0029; B81B 7/00

See application file for complete search history.

(71) Applicant: **TOYODA GOSEI CO., LTD.**,
Kiyosu-shi, Aichi-ken (JP)

(56) **References Cited**

(72) Inventors: **Genki Sago**, Kiyosu (JP); **Nozomu Uesugi**, Kiyosu (JP); **Yasuyuki Nakamura**, Kiyosu (JP); **Kazumasa Baba**, Kiyosu (JP)

U.S. PATENT DOCUMENTS

(73) Assignee: **TOYODA GOSEI CO., LTD.**,
Aichi-pref. (JP)

D330,363	S	*	10/1992	Inoi	D13/101
5,452,878	A	*	9/1995	Gravesen	F15C 5/00
						251/129.01
6,376,971	B1	*	4/2002	Pelrine	F04B 35/00
						310/363
D493,135	S	*	7/2004	Moler	D13/101
D493,416	S	*	7/2004	Moler	D13/101
D496,330	S	*	9/2004	Moler	D13/101
D563,865	S	*	3/2008	Ahlgren	D13/101
9,433,537	B2	*	9/2016	Zelka	B32B 27/08

(Continued)

(**) Term: **15 Years**

Primary Examiner — Elizabeth J Oswecki

(21) Appl. No.: **29/638,396**

(74) *Attorney, Agent, or Firm* — Posz Law Group, PLC

(22) Filed: **Feb. 27, 2018**

(30) **Foreign Application Priority Data**

(57) **CLAIM**

- Sep. 29, 2017 (JP) 2017-021534
- Sep. 29, 2017 (JP) 2017-021535
- Sep. 29, 2017 (JP) 2017-021536
- Sep. 29, 2017 (JP) 2017-021537
- Sep. 29, 2017 (JP) 2017-021538
- Sep. 29, 2017 (JP) 2017-021539

The ornamental design for a polymer actuator, as shown and described.

DESCRIPTION

(51) **LOC (12) Cl.** **13-03**

(52) **U.S. Cl.**
USPC **D13/174; D13/101**

(58) **Field of Classification Search**
 USPC D13/101, 121, 123, 180, 182, 184, 199,
 D13/174, 110; 74/78, 77, 81, 606 R, 128,
 74/130, 141.5, 473.11, 473.12, 473.23,
 74/614, 615; 345/156; 310/300-311;
 359/224.1, 291, 295
 CPC ... H01L 41/047; H01L 41/04; H01L 41/0973;
 G02B 26/0825; B81B 3/0083; B81B
 3/0086; B81B 3/0089; B81B 3/0064;
 B81B 7/0009; B81B 7/0012; B81B

FIG. 1 is a perspective view of a polymer actuator showing our new design;
 FIG. 2 is a front view thereof;
 FIG. 3 is a rear view thereof;
 FIG. 4 is a left side view thereof;
 FIG. 5 is a right side view thereof;
 FIG. 6 is a top plan view thereof;
 FIG. 7 is a bottom plan view thereof; and,
 FIG. 8 is an exploded perspective view thereof, shown in a used condition with polymer thin film shown in broken lines. The broken lines shown in the drawings form no part of the claimed design.
 The dash-dot lines represent only the boundary between the claimed design and the unclaimed environment.

1 Claim, 8 Drawing Sheets

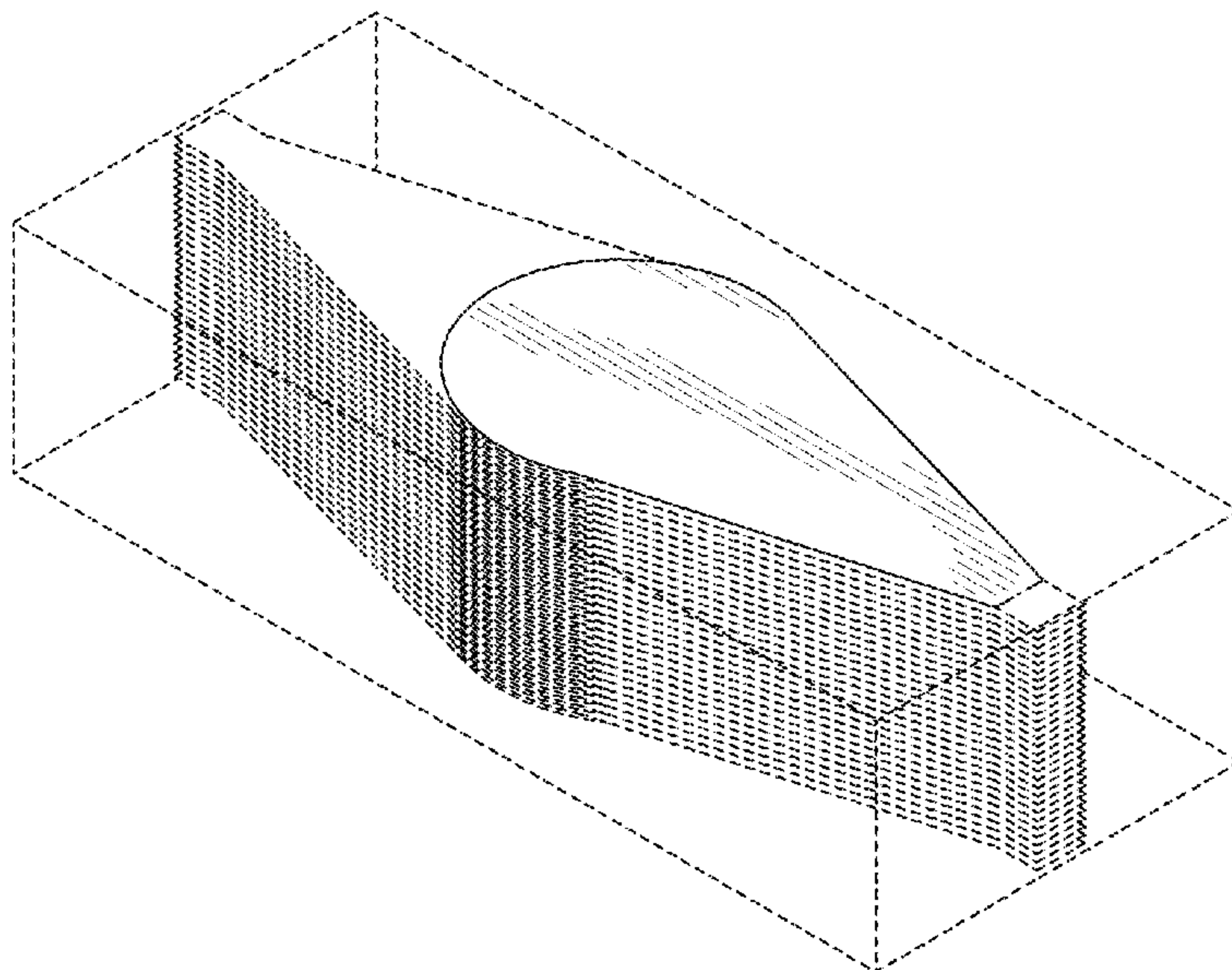

(56)

References Cited

U.S. PATENT DOCUMENTS

2010/0007245 A1* 1/2010 Jager B32B 27/28
310/330
2012/0169184 A1* 7/2012 Pelrine H01L 41/45
310/365
2013/0175898 A1* 7/2013 Brokken G02B 26/0825
310/300
2013/0176608 A1* 7/2013 Brokken G02B 26/0825
359/224.1

* cited by examiner

FIG. 1

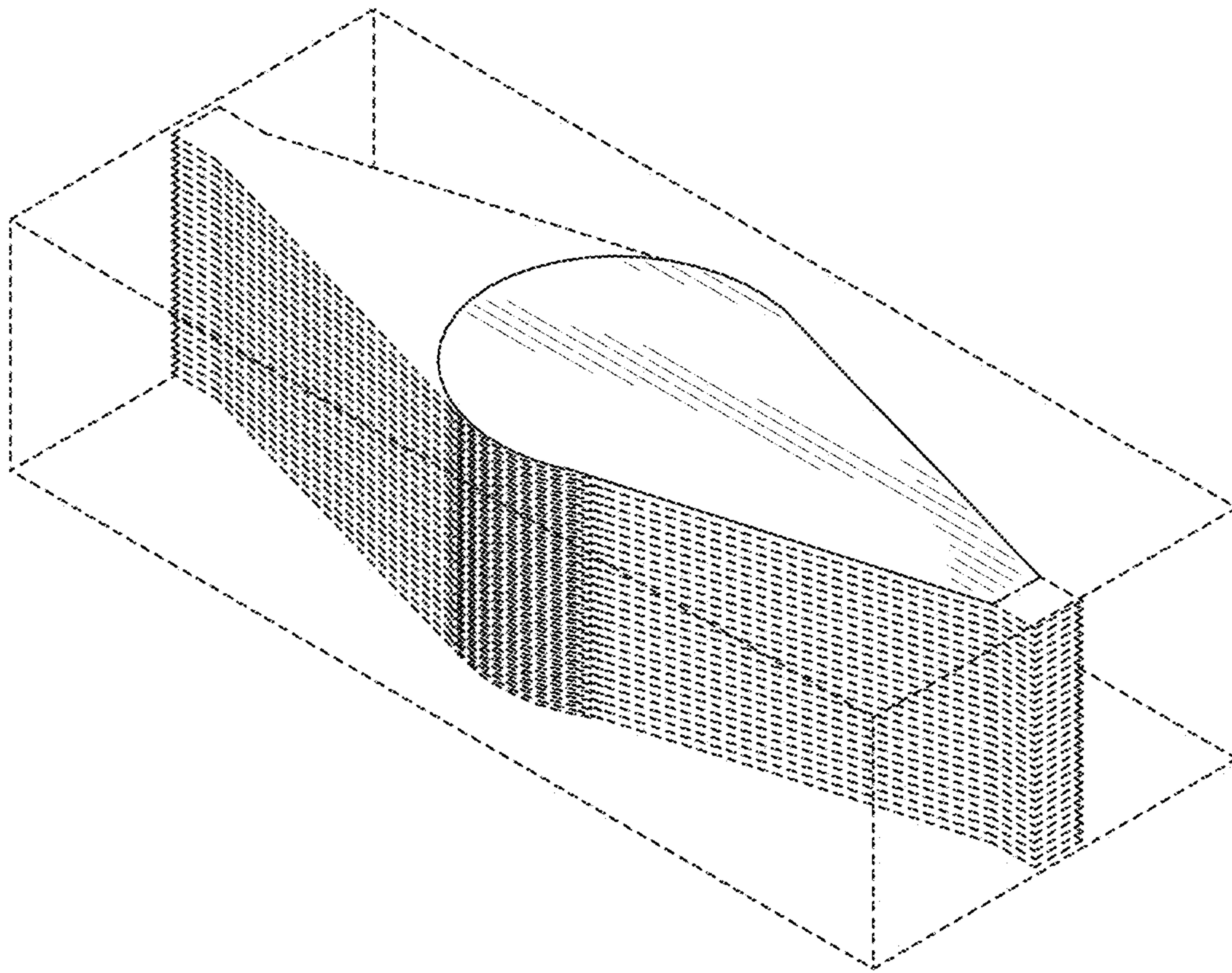

FIG. 2

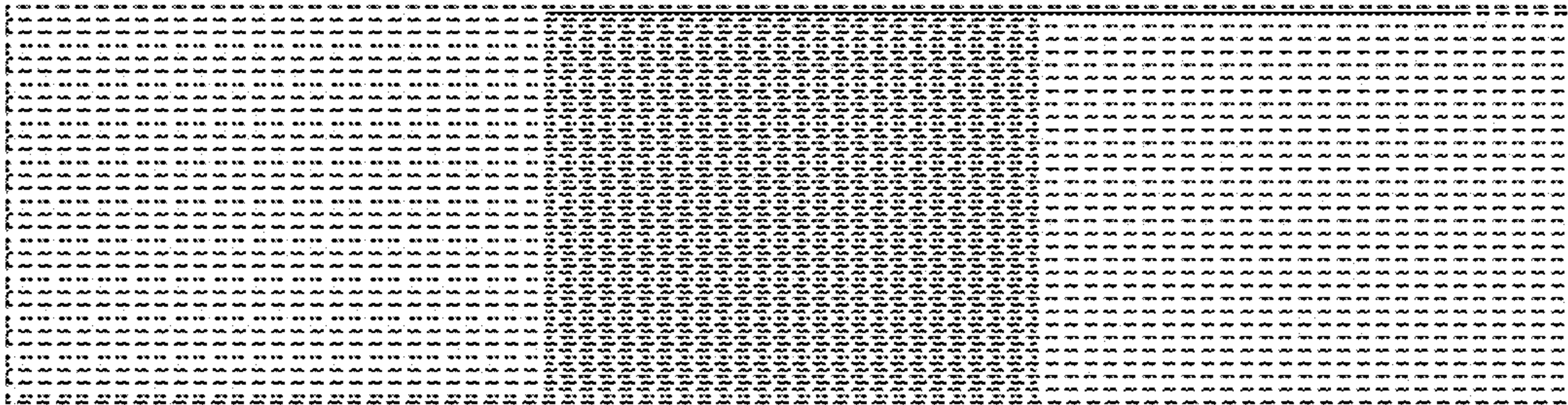

FIG. 3

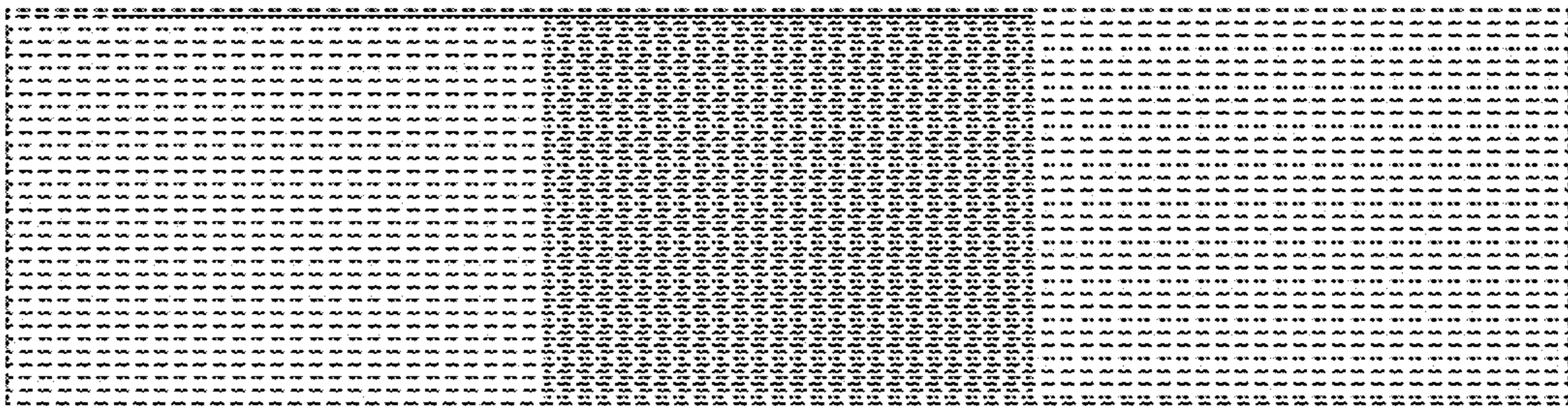

FIG. 4

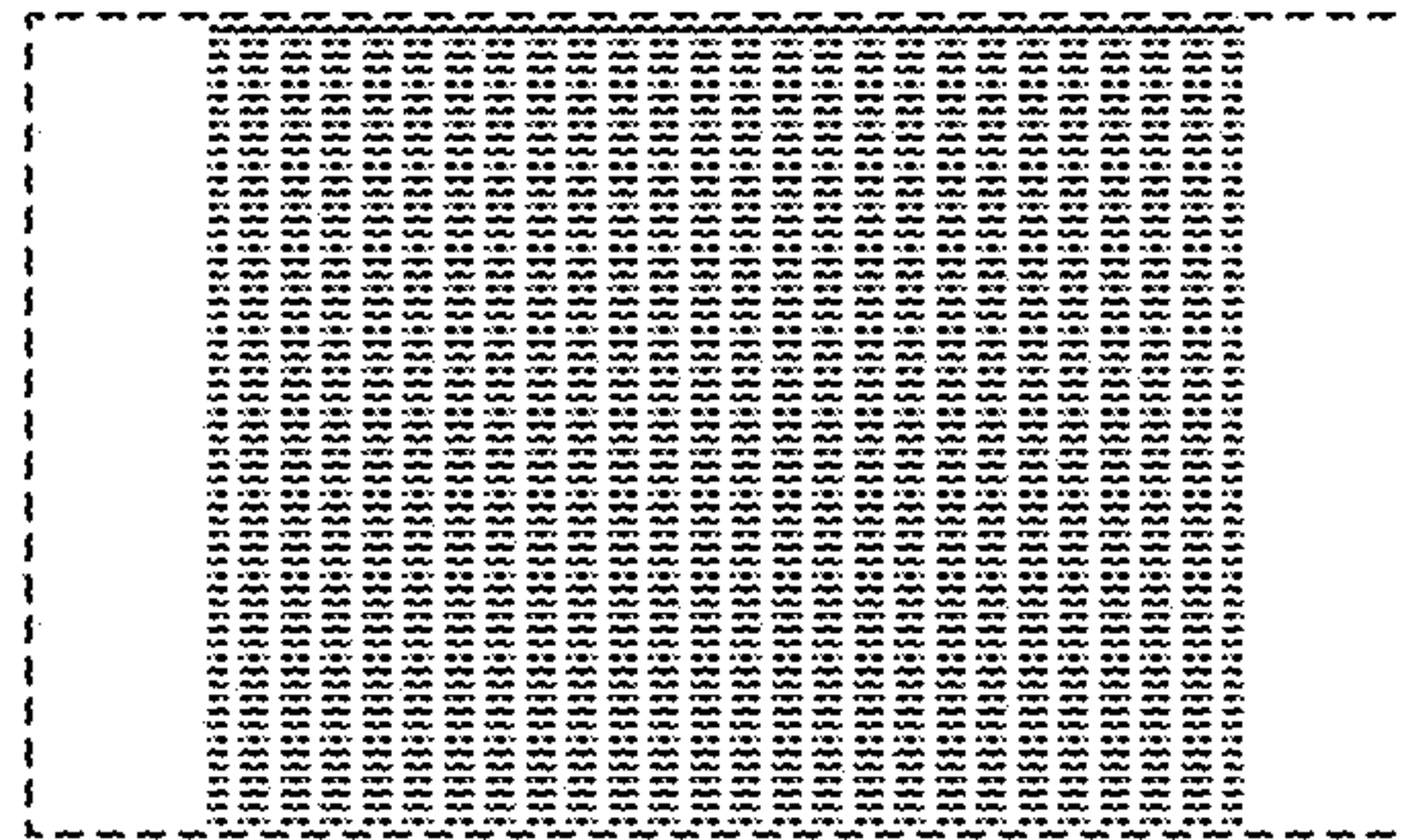

FIG. 5

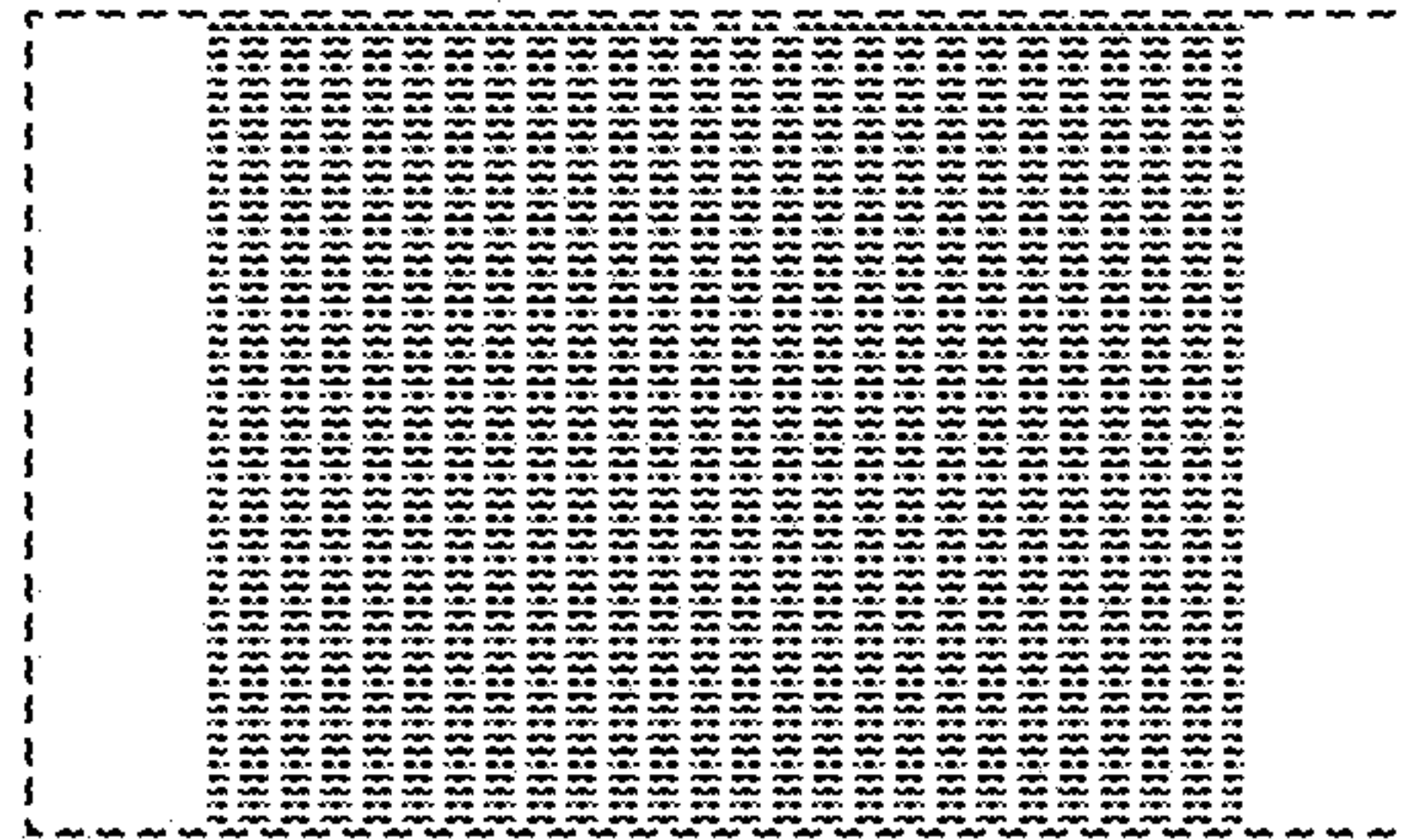

FIG. 6

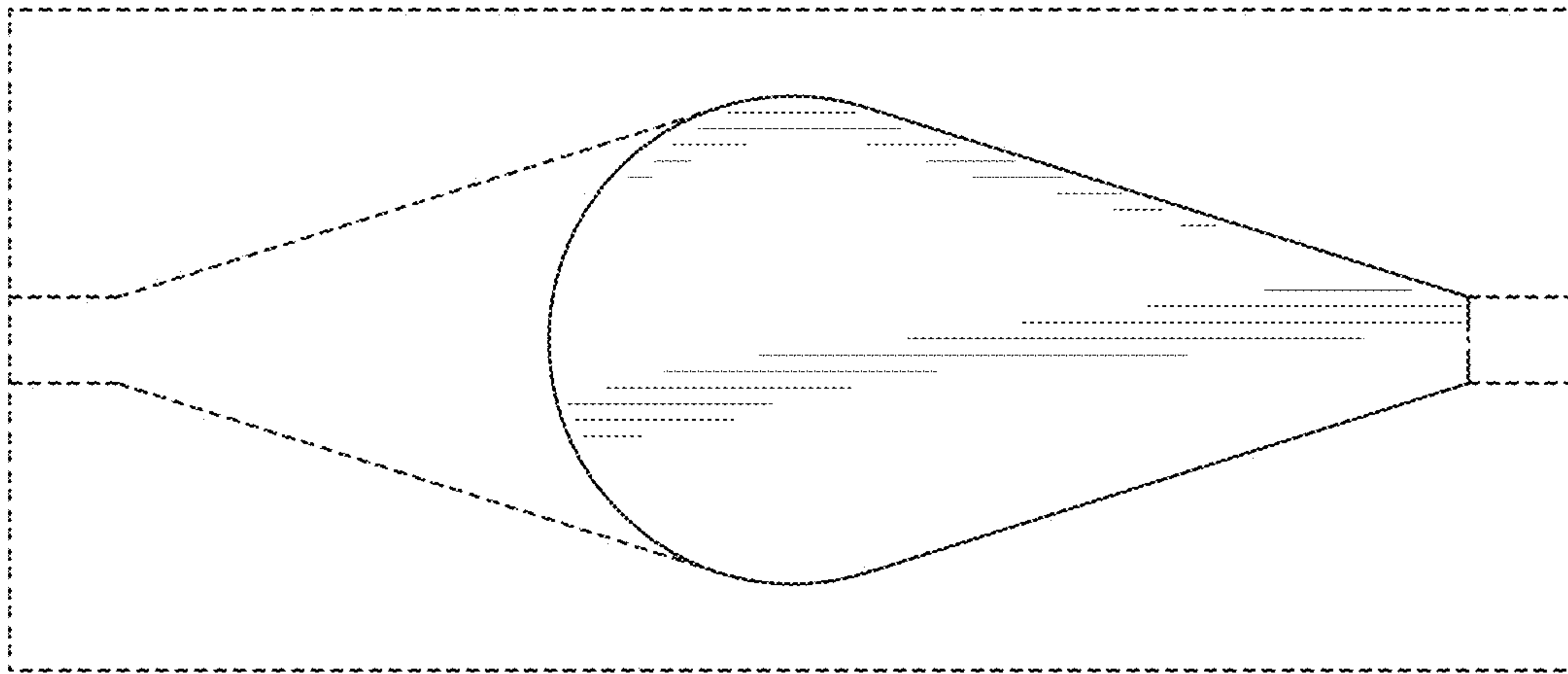

FIG. 7

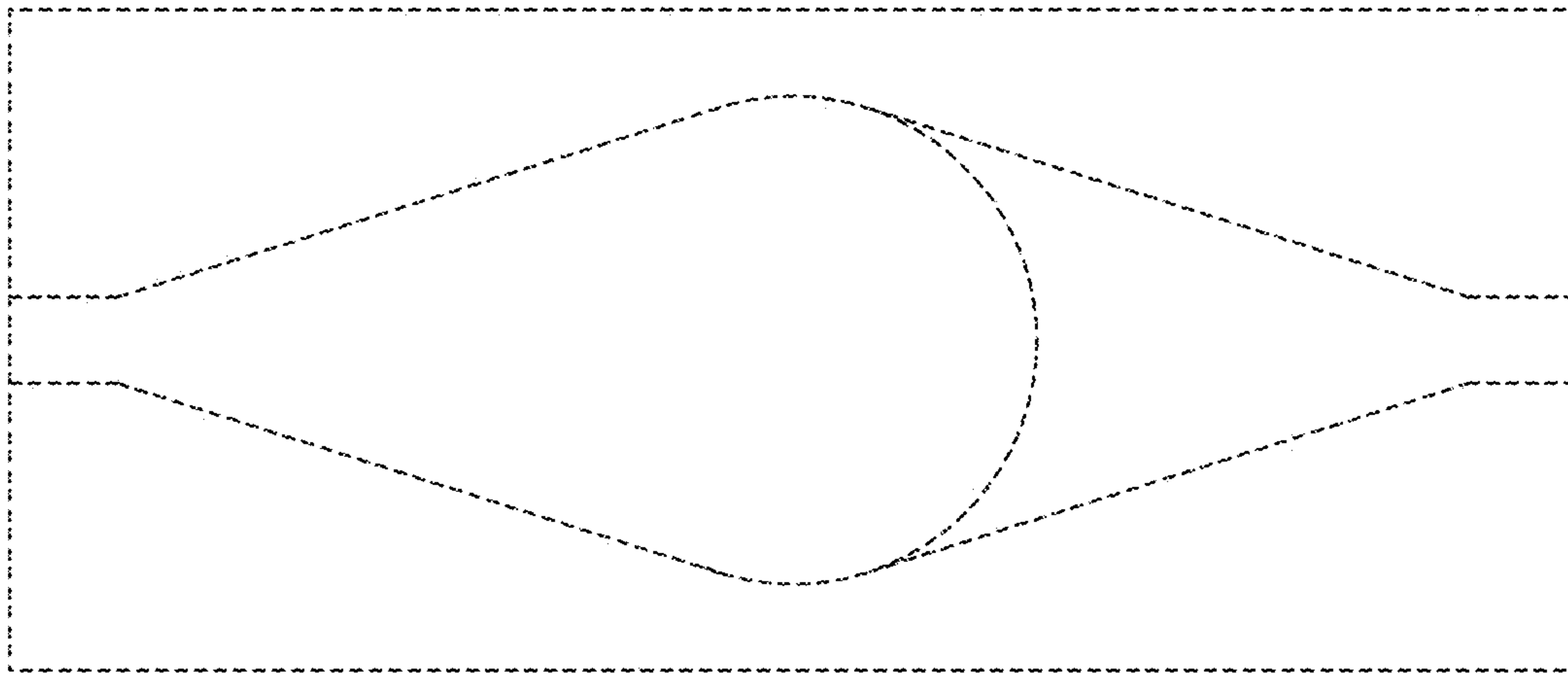

FIG. 8

