



US00D892611S

(12) **United States Design Patent** (10) **Patent No.:** **US D892,611 S**
Denison et al. (45) **Date of Patent:** **** Aug. 11, 2020**

(54) **RECLOSABLE PACKAGING**

(71) Applicant: **Kraft Foods Group Brands LLC**,
Chicago, IL (US)

(72) Inventors: **Joseph C. Denison**, Chicago, IL (US);
Stuart M. Leslie, Larchmont, NY (US);
Jason Billig, Thornwood, NY (US)

(73) Assignee: **Kraft Foods Group Brands LLC**,
Chicago, IL (US)

(**) Term: **15 Years**

(21) Appl. No.: **29/672,931**

(22) Filed: **Dec. 10, 2018**

(51) **LOC (12) Cl.** **09-03**

(52) **U.S. Cl.**
USPC **D9/425**

(58) **Field of Classification Search**
USPC D9/414, 415, 418, 424, 425, 426, 430;
D7/601, 602, 629, 630
CPC B65D 2543/00296; B65D 5/4204; B65D
1/34; B65D 25/54; B65D 2543/00731;
B65D 85/34; B65D 5/5021; B65D
81/3453; B65D 2205/00; B65D
2543/0024; B65D 25/10; B65D 43/021;
B65D 25/04; B65D 75/366; B65D
77/003; B65D 77/02; B65D 5/4295;
B65D 5/5038; B65D 1/0207; B65D
2543/00648; B65D 81/263; B65D 1/38;
B65D 2577/205; B65D 2543/00759;
B65D 71/70; B65D 2543/00231; B65D
43/02; B65D 5/2047; B65D 1/0223;
B65D 1/40; B65D 75/522; B65D
81/3216; B65D 2519/00273; B65D
75/322; B65D 15/22; B65D 2519/00034
See application file for complete search history.

(56) **References Cited**

U.S. PATENT DOCUMENTS

D286,729 S * 11/1986 Tzifkansky D7/629
4,787,527 A * 11/1988 Monetti B65D 25/22
220/557
D336,613 S * 6/1993 Zutler D9/423
D482,277 S * 11/2003 Castellanos D9/418
D483,664 S * 12/2003 Cadiente D9/418
D528,014 S * 9/2006 Cutts D9/761
D587,993 S * 3/2009 Vovan D9/416
8,083,089 B2 * 12/2011 Vovan B65D 43/162
220/270
D685,628 S * 7/2013 Durdon D9/420

(Continued)

Primary Examiner — Lauren R Calve

(74) *Attorney, Agent, or Firm* — Fitch, Even, Tabin & Flannery LLP

(57) **CLAIM**

We claim the ornamental design for a reclosable packaging, as shown and described.

DESCRIPTION

FIG. 1 is a perspective view of a reclosable packaging showing our new design.
FIG. 2 is a top view thereof.
FIG. 3 is a front view thereof.
FIG. 4 is a left side view thereof.
FIG. 5 is a rear view thereof.
FIG. 6 is a right side view thereof.
FIG. 7 is a bottom view thereof.
FIG. 8 is a perspective view of a second embodiment of the reclosable packaging showing our new design.
FIG. 9 is a top view thereof.
FIG. 10 is a front view thereof.
FIG. 11 is a left side view thereof.
FIG. 12 is a rear view thereof.
FIG. 13 is a right side view thereof; and,
FIG. 14 is a bottom view thereof.
The broken lines shown represent portions of the reclosable packaging that form no part of the claimed design.

1 Claim, 4 Drawing Sheets

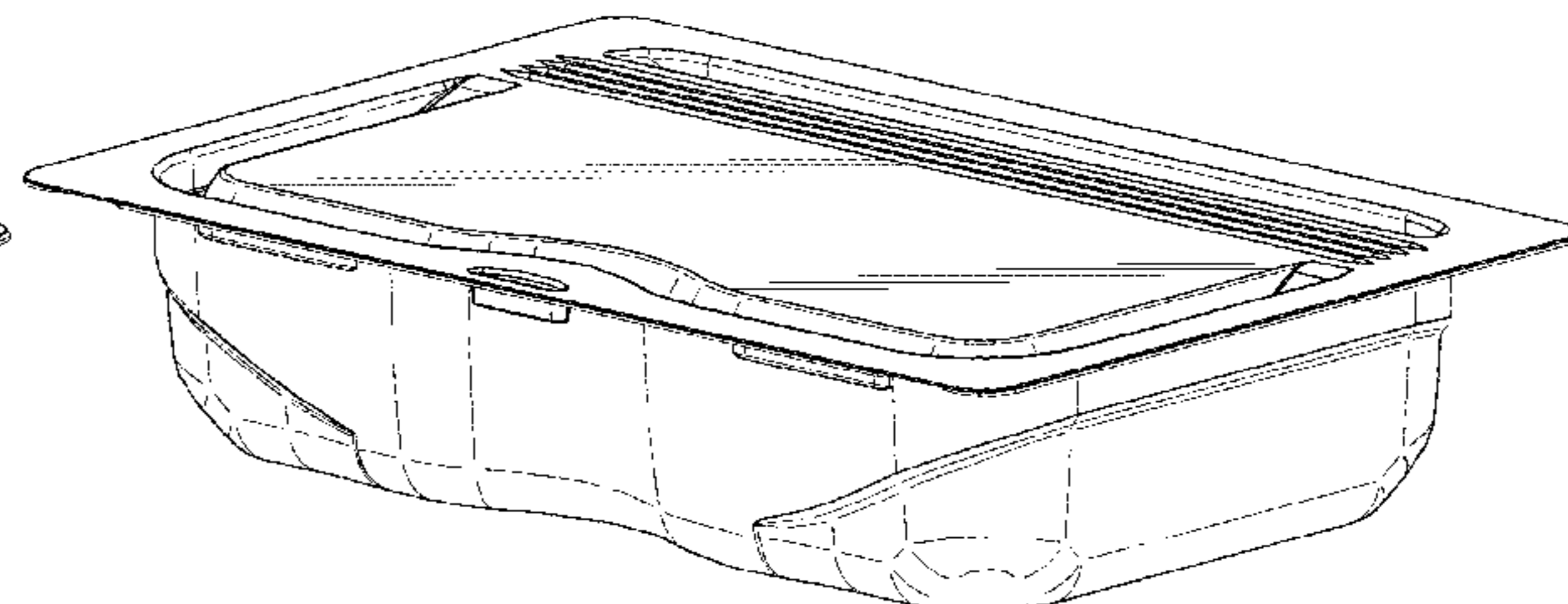
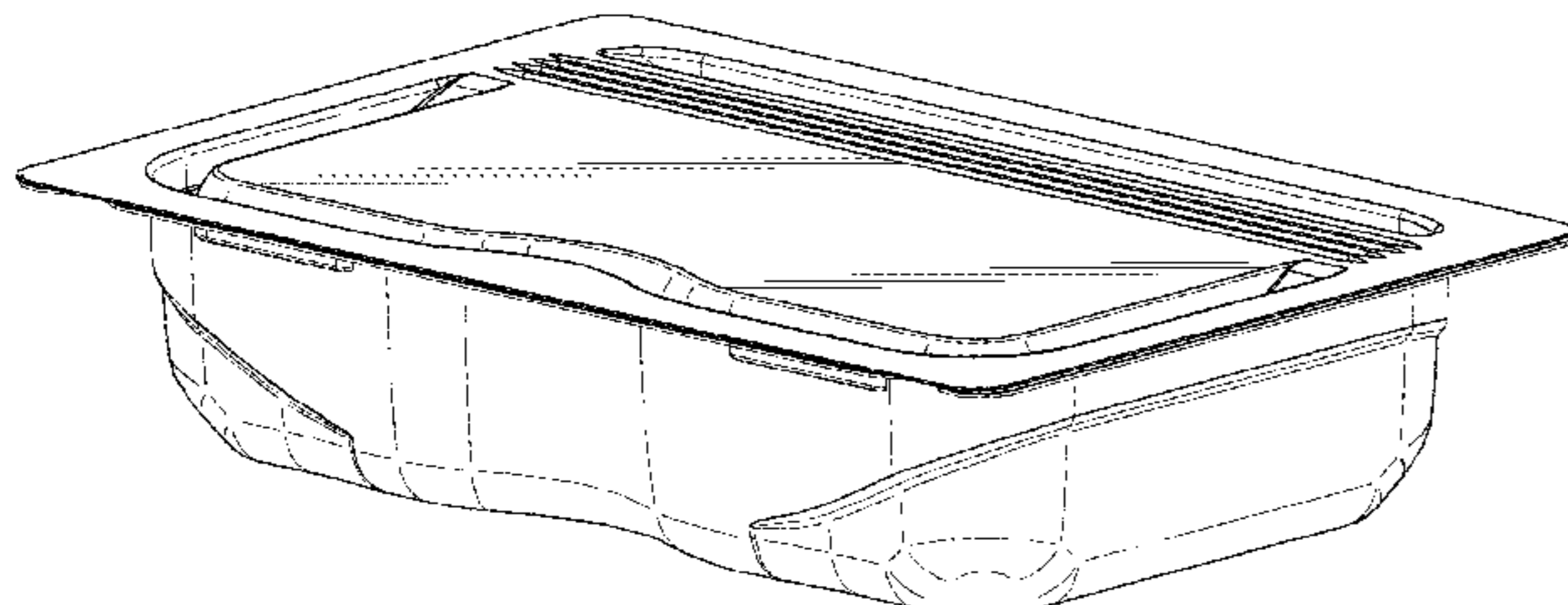

(56)

References Cited

U.S. PATENT DOCUMENTS

D691,037 S * 10/2013 Chen D9/423
D693,672 S * 11/2013 Bontrager D9/425
9,120,595 B2 * 9/2015 Chou B65D 77/2016
2007/0092611 A1 * 4/2007 Hinze B65D 43/021
426/129
2010/0044265 A1 * 2/2010 Ragsdale B65D 1/36
206/518
2013/0068654 A1 * 3/2013 MacDonald B65D 47/043
206/524.6
2013/0341327 A1 * 12/2013 Bontrager B65D 43/0252
220/214
2014/0069930 A1 * 3/2014 Oakes B65D 25/42
220/525
2014/0263384 A1 * 9/2014 Irsch B65D 21/0219
220/780
2015/0291308 A1 * 10/2015 Irsch B65D 21/0219
206/508
2017/0158397 A1 * 6/2017 Guirguis B65D 55/024

* cited by examiner

FIG. 1

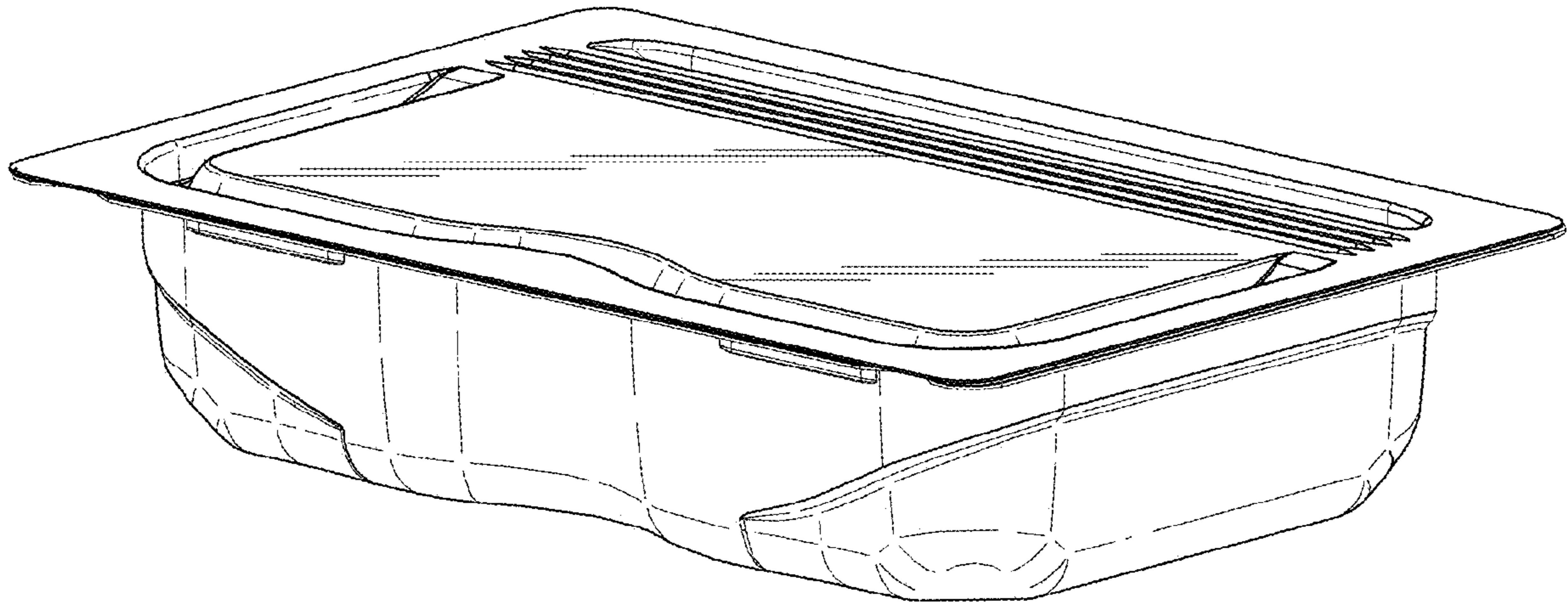

FIG. 2

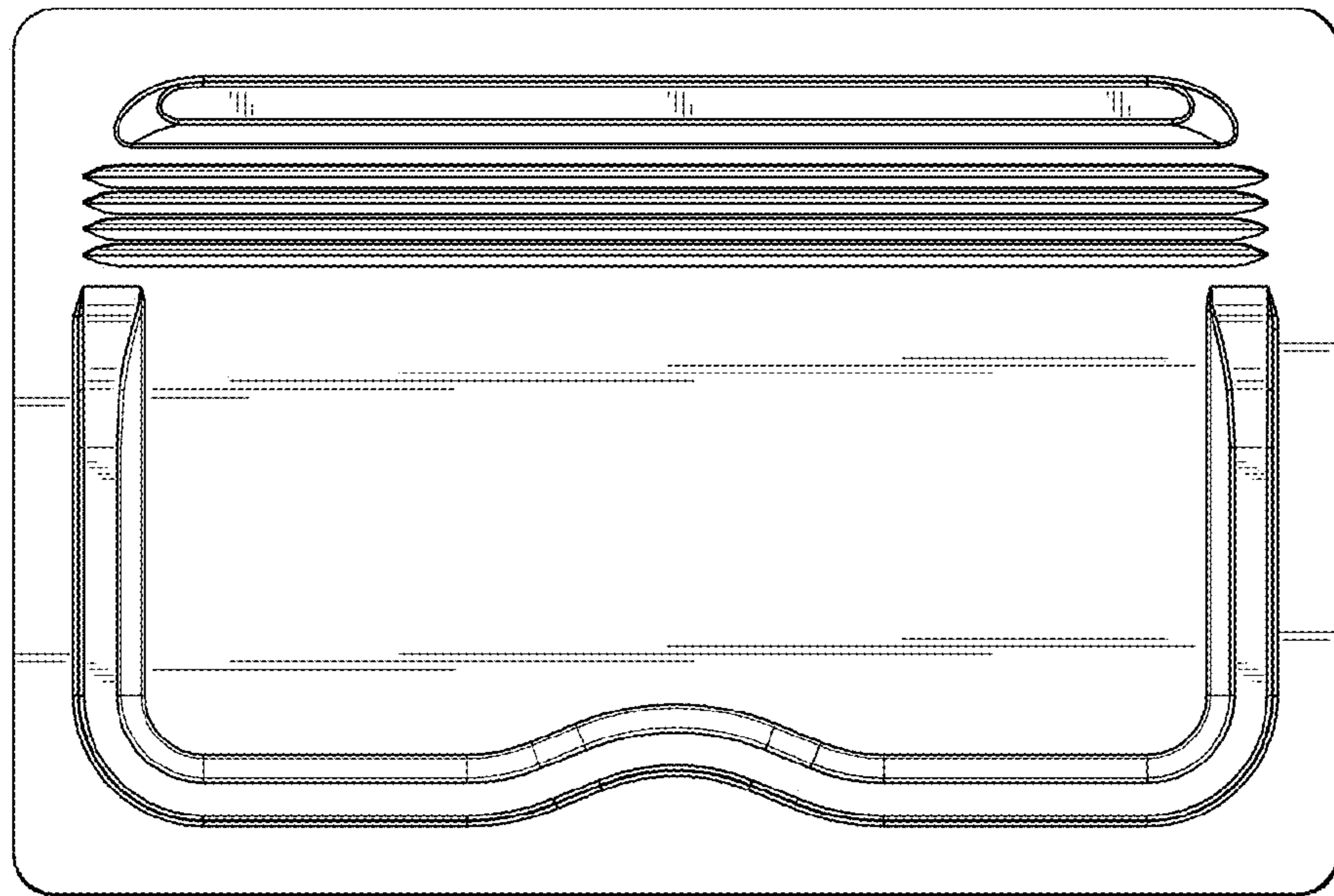

FIG. 3

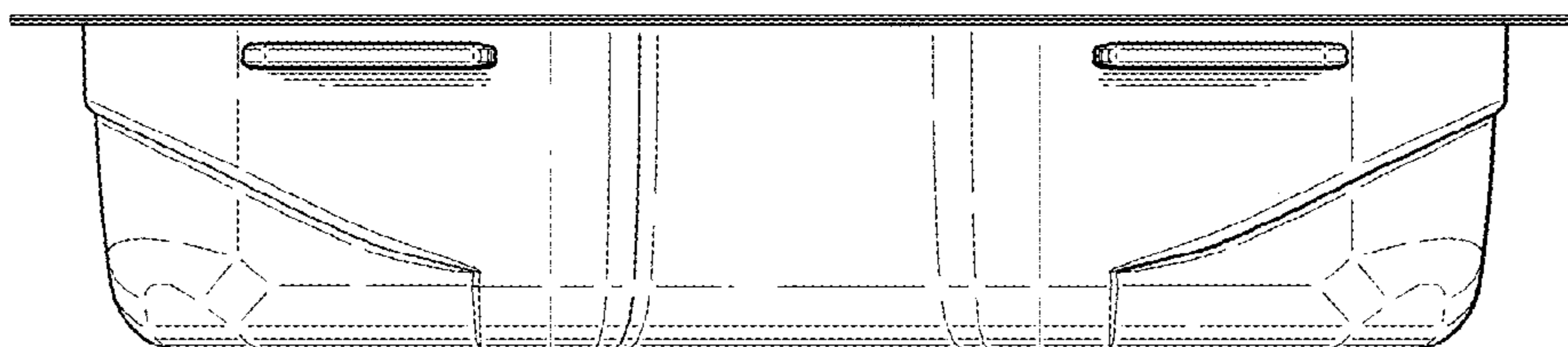

FIG. 4

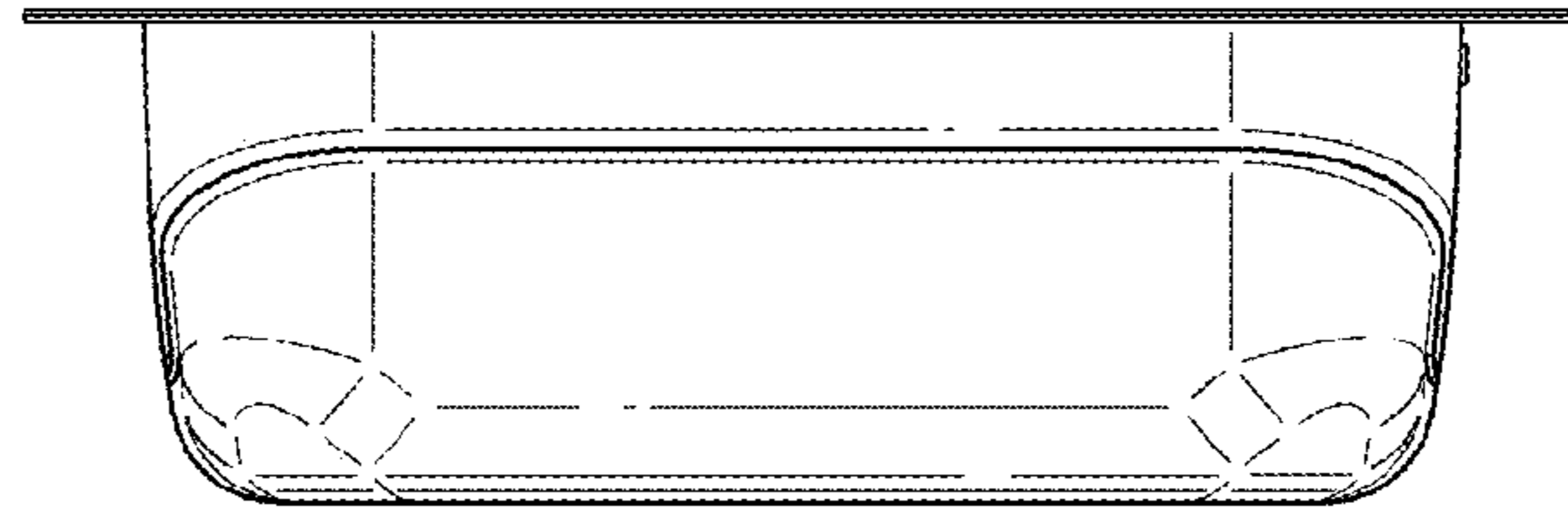

FIG. 5

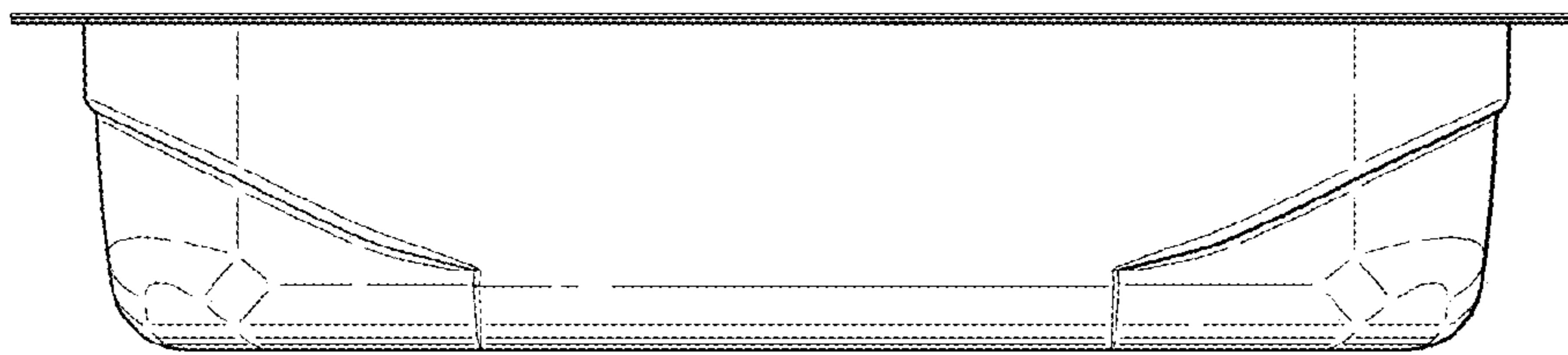

FIG. 6

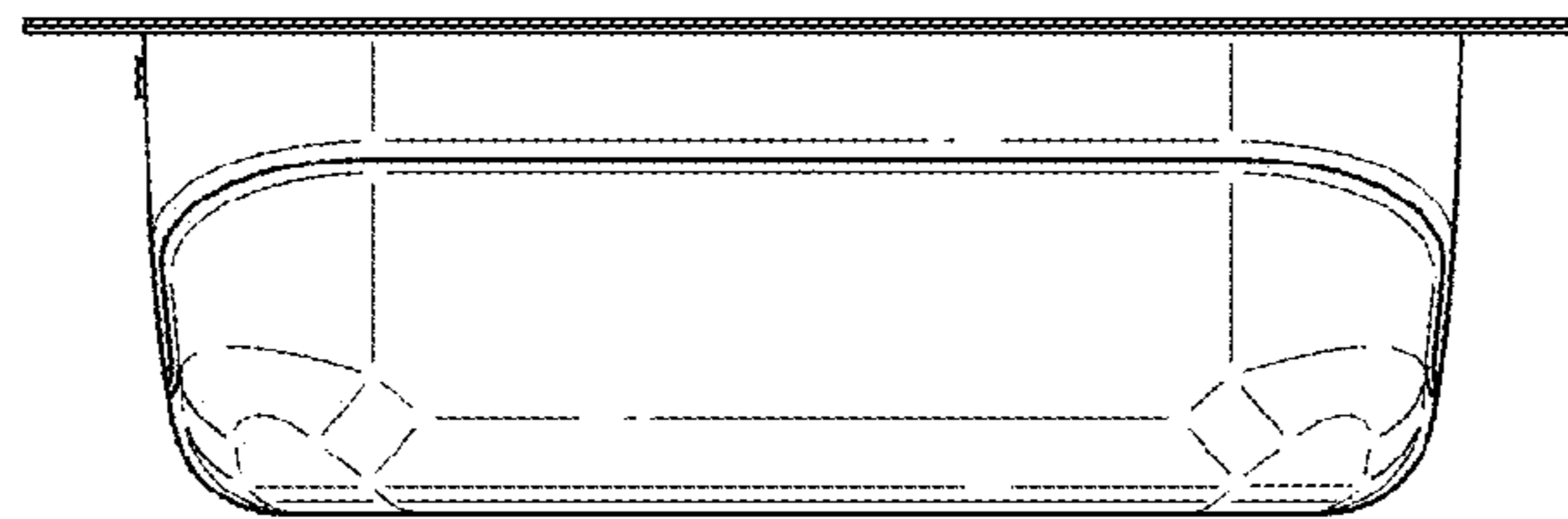

FIG. 7

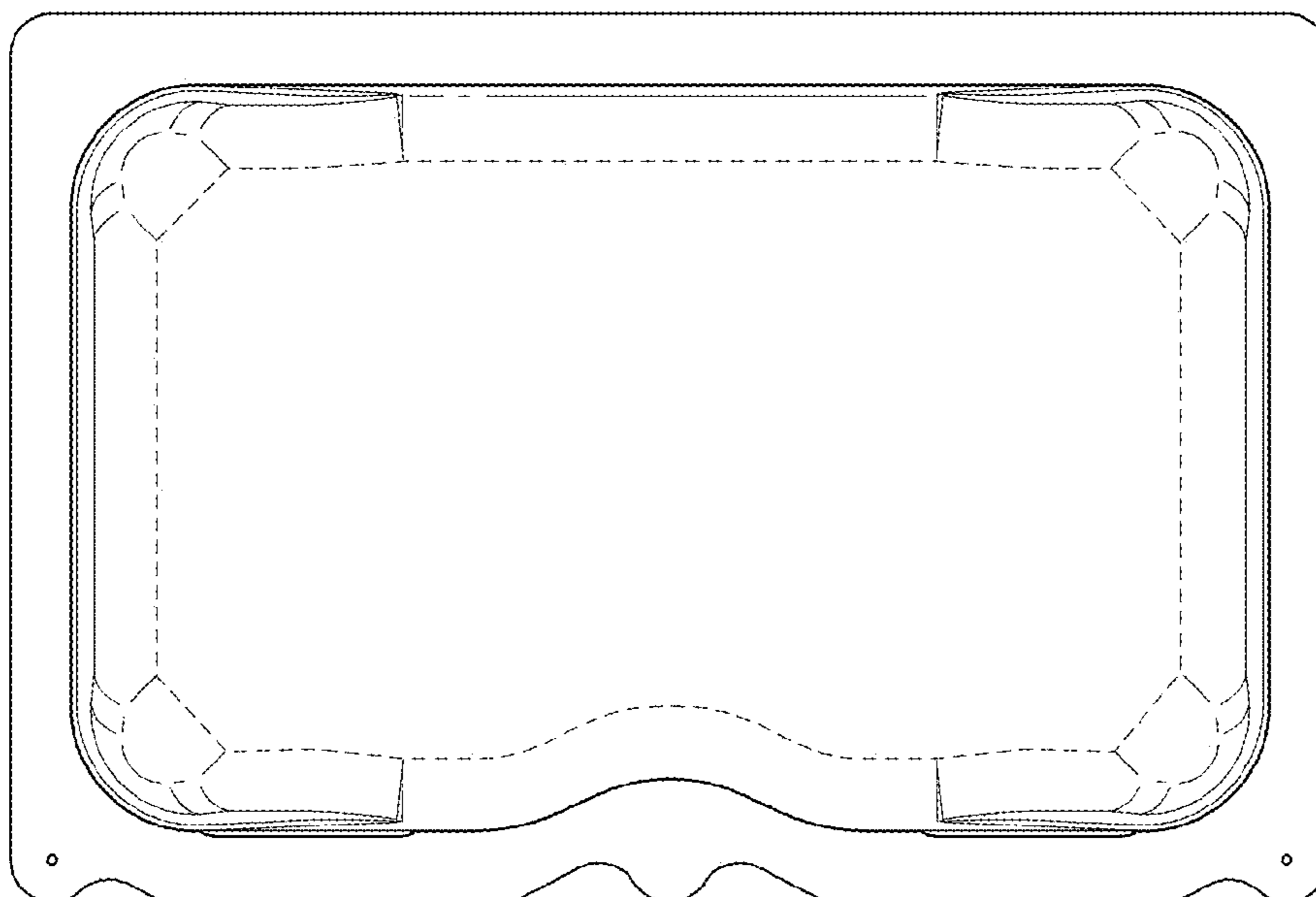

FIG. 8

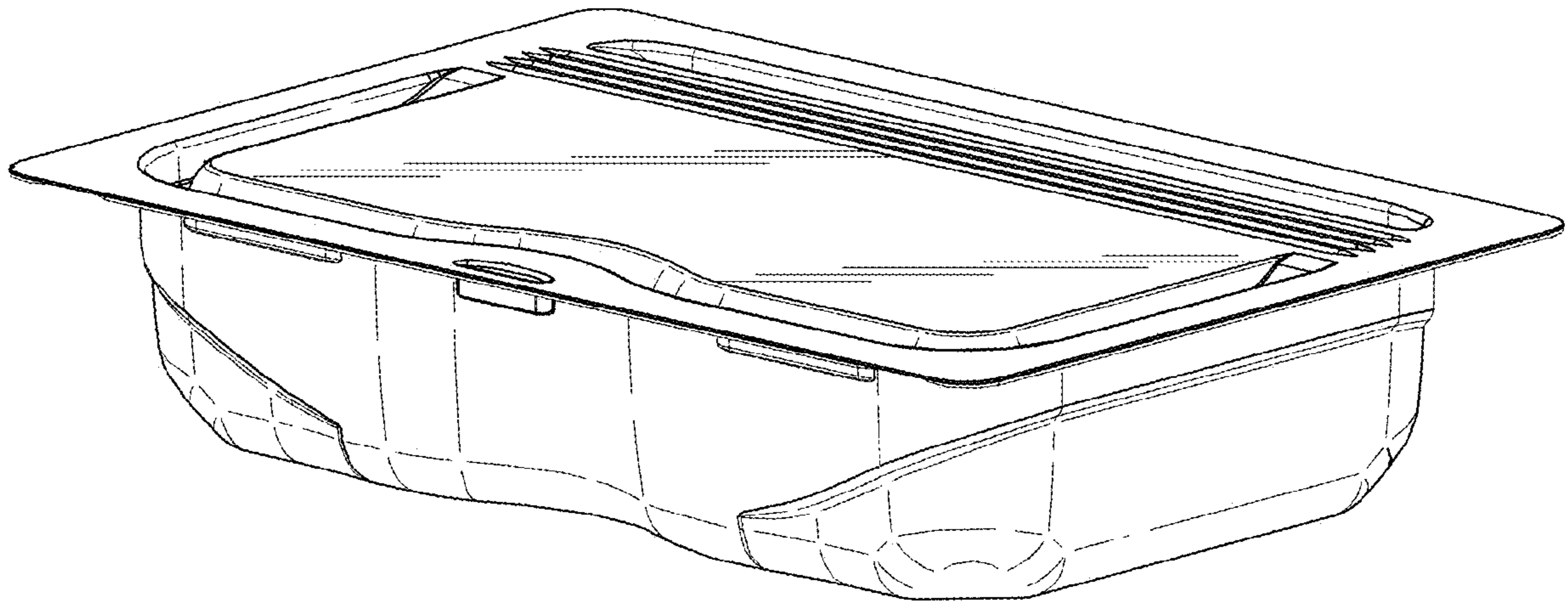

FIG. 9

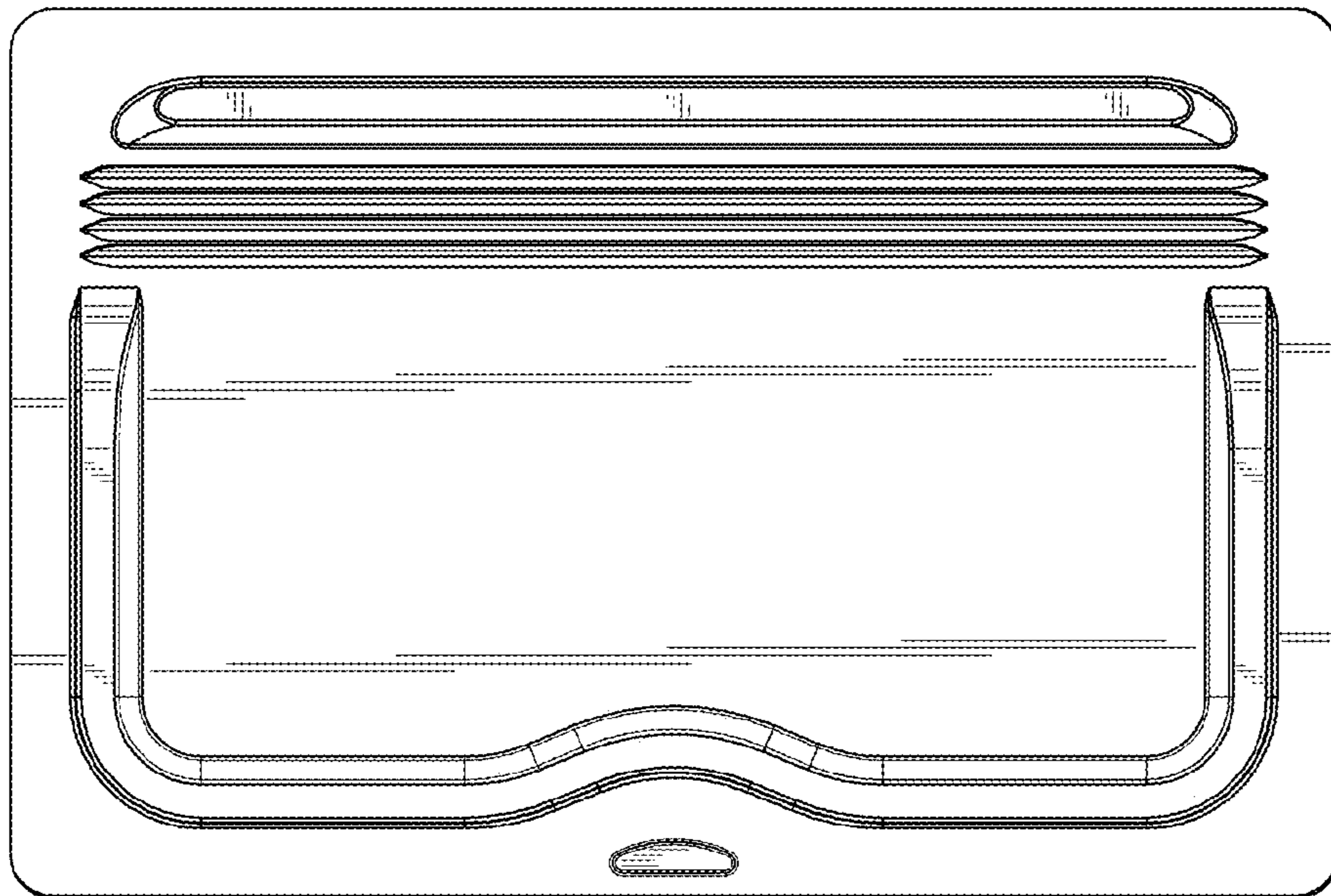

FIG. 10

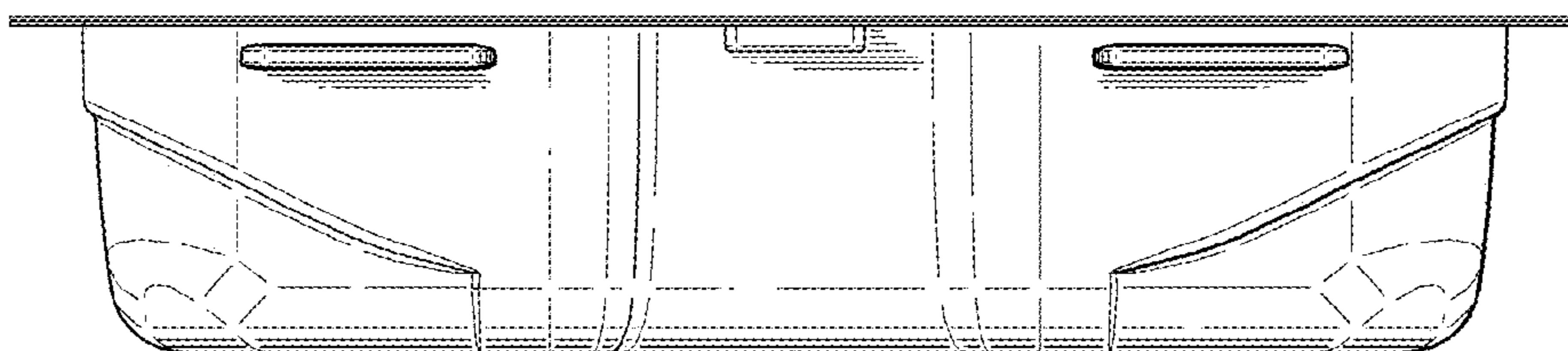

FIG. 11

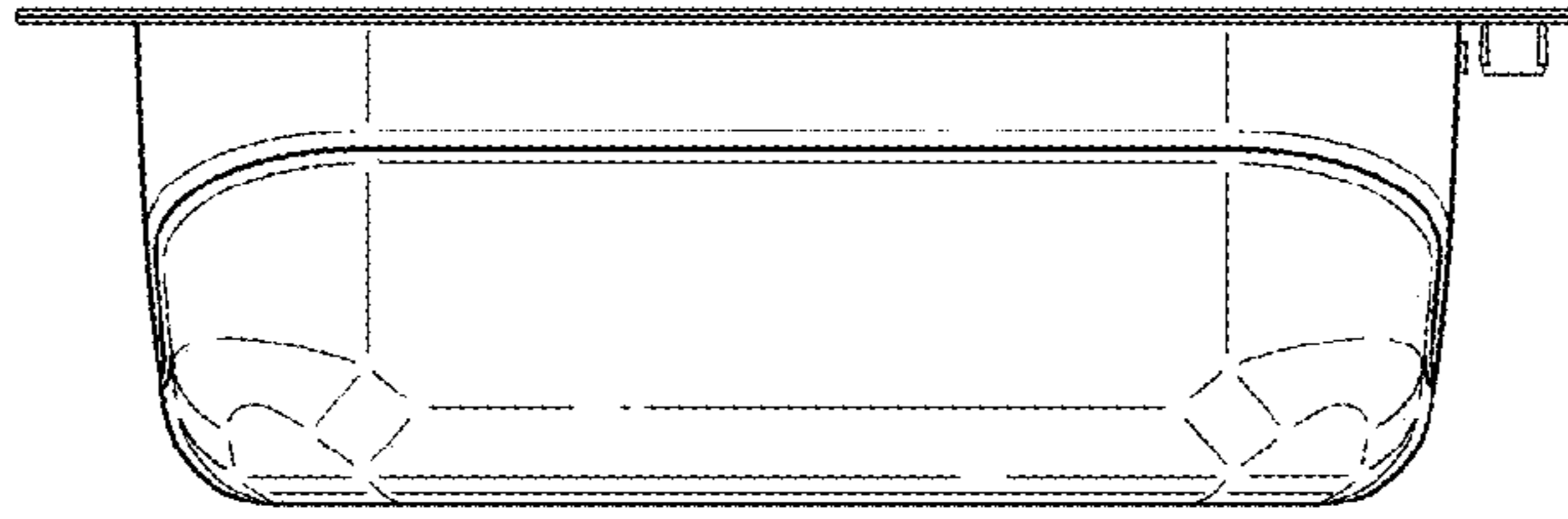

FIG. 12

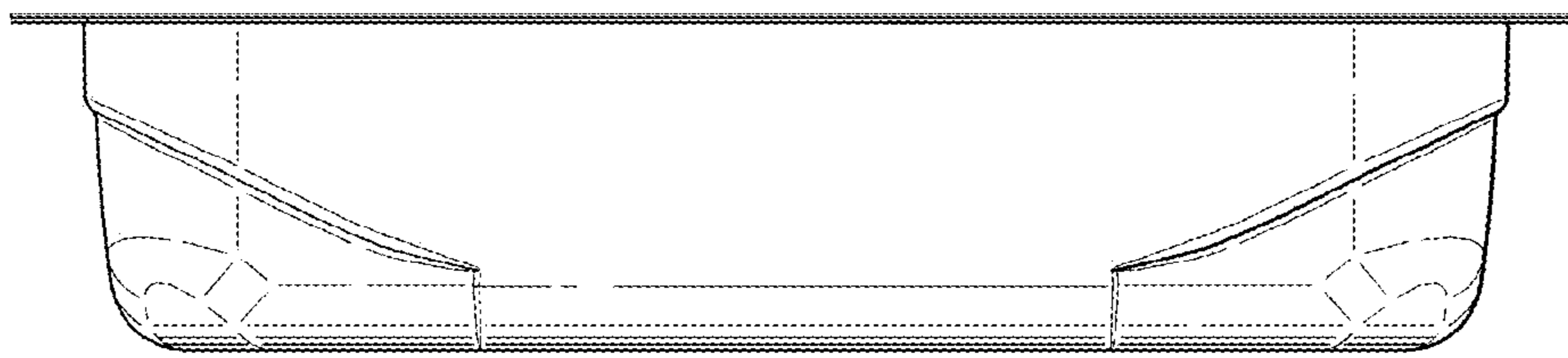

FIG. 13

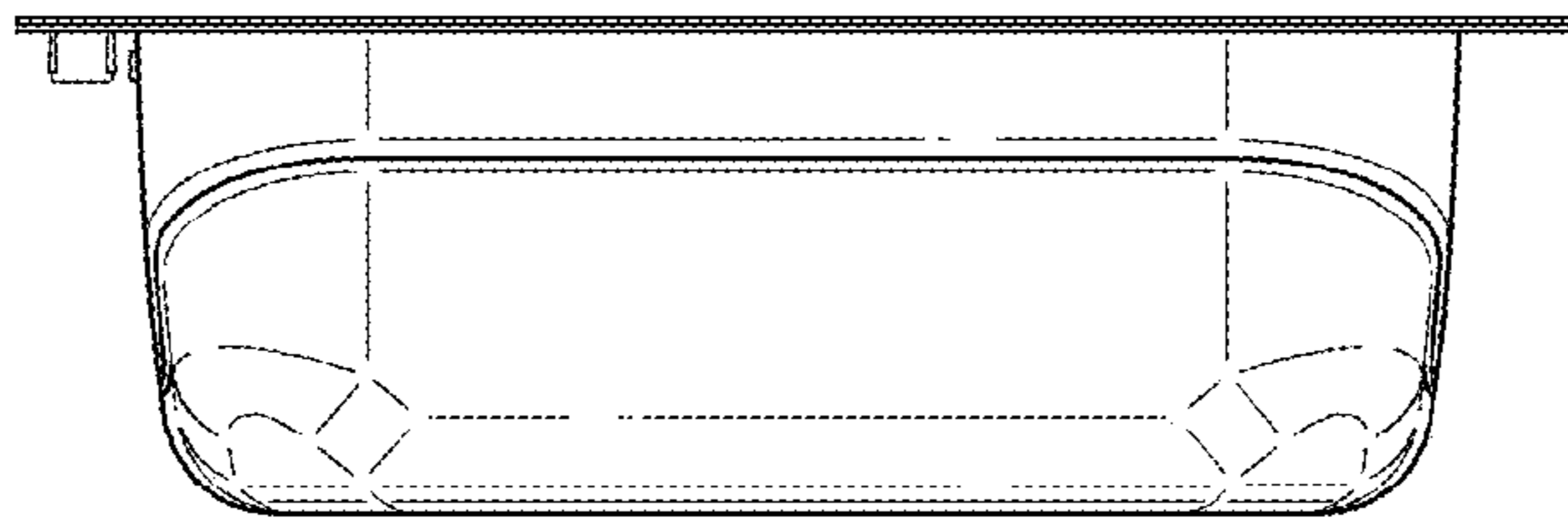

FIG. 14

