

US00D892464S

(12) **United States Design Patent**
Yim

(10) **Patent No.:** **US D892,464 S**

(45) **Date of Patent:** **** Aug. 11, 2020**

- (54) **HAT**
- (71) Applicant: **Cheveux Corporation**, Ridgefield, NJ (US)
- (72) Inventor: **Hyo Jeong Yim**, Ridgefield, NJ (US)
- (73) Assignee: **CHEVEUX CORPORATION**, Ridgefield, NJ (US)

- D445,560 S * 7/2001 Nam D2/865
- 6,711,749 B2 * 3/2004 White A42B 1/225
2/195.8
- D595,033 S * 6/2009 Lynn D2/882
- D818,671 S * 5/2018 Yim D2/889
- D828,980 S * 9/2018 Yim D2/882
- D835,889 S * 12/2018 Yim D2/889

(Continued)

- (**) Term: **15 Years**
- (21) Appl. No.: **29/689,364**
- (22) Filed: **Apr. 29, 2019**

Related U.S. Application Data

- (63) Continuation of application No. 29/591,563, filed on Jan. 20, 2017, now Pat. No. Des. 846,839.
- (51) **LOC (12) Cl.** **02-03**
- (52) **U.S. Cl.**
USPC **D2/889**
- (58) **Field of Classification Search**
USPC D2/865, 866, 867, 869, 870, 873, 878,
D2/879, 883, 888, 889, 891, 895
CPC .. A42B 1/00; A42B 1/004; A42B 1/04; A42B
1/041; A42B 1/12; A42B 1/225; A42B
1/248
See application file for complete search history.

(56) **References Cited**

U.S. PATENT DOCUMENTS

- 167,538 A * 9/1875 Isidor et al. A42B 1/043
2/195.7
- D58,384 S * 7/1921 Jeffries D2/889
- D62,863 S * 8/1923 Strauss D2/889
- 1,616,475 A * 2/1927 Tracey A42B 1/04
2/195.7
- 3,169,252 A * 2/1965 Goldstein A42B 1/046
2/203

OTHER PUBLICATIONS

C. C. Beanie Tail Soft Stretch Cable Knit Messy High Bun Ponytail Beanie Hat, [on-line]; [first made available at Amazon.com on Jan. 25, 2017]; [original retrieved from the Internet on Mar. 7, 2018 by Examiner when searching prior-filed related applications to the inventor]; URL: see first page. (9 pgs). (Year: 2017).*

(Continued)

Primary Examiner — Jasmine Mlinarcik

(74) *Attorney, Agent, or Firm* — Tarter Krinsky & Drogin LLP

(57) **CLAIM**

The ornamental design for a hat, as shown and described.

DESCRIPTION

FIG. 1 is a front perspective view of a hat;
FIG. 2 is a front view thereof;
FIG. 3 is a rear view thereof;
FIG. 4 is a first side view thereof;
FIG. 5 is a second side view thereof;
FIG. 6 is a top view thereof;
FIG. 7 is a bottom view thereof; and,
FIG. 8 is an exemplary view of a user wearing the hat.
The broken lines along the brim of the hat depict portions of the hat that form no part of the claimed design. The broken line depiction of the partial human figure in FIG. 8 illustrates the hat in a position of use and forms no part of the claimed design.

1 Claim, 8 Drawing Sheets

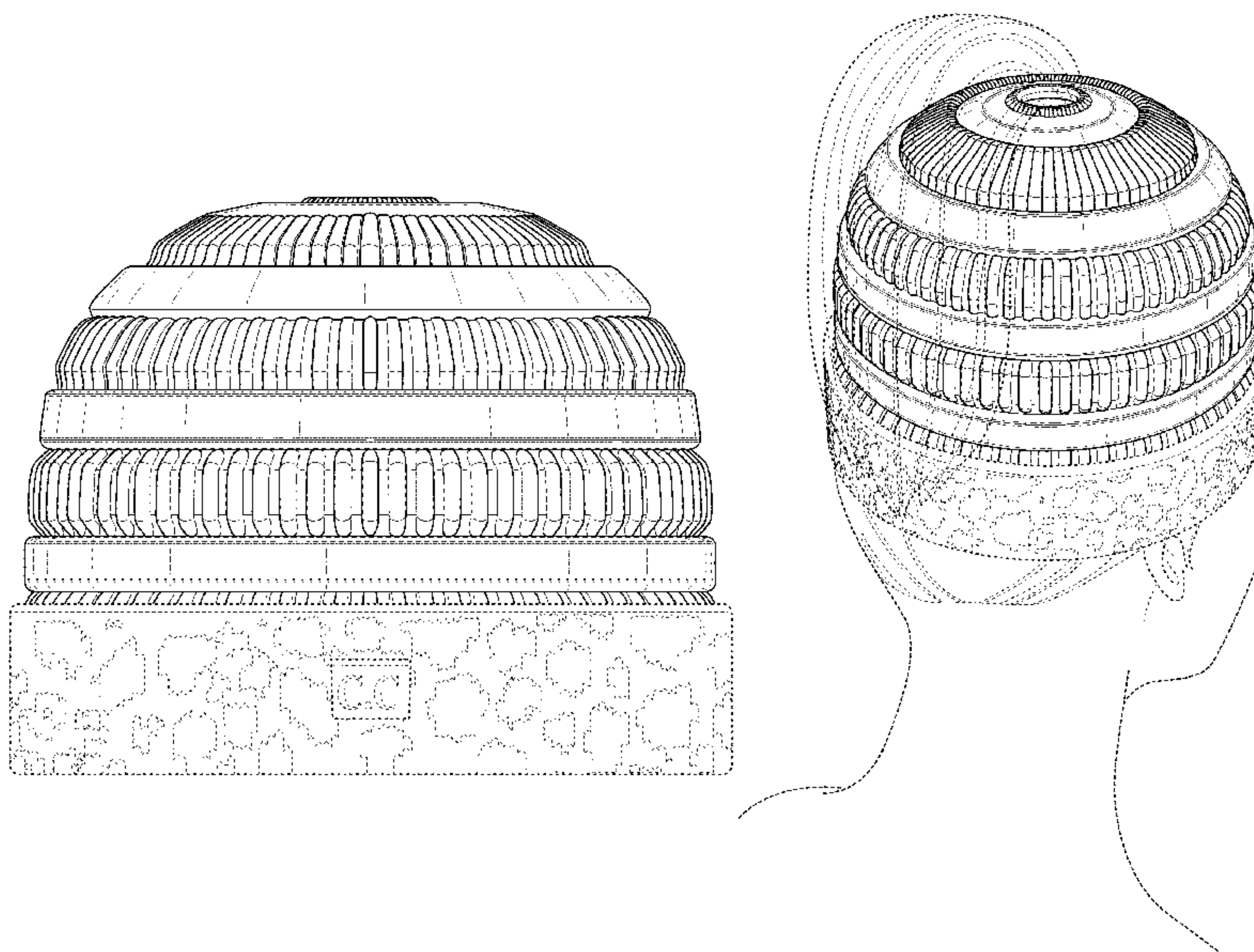

(56)

References Cited

U.S. PATENT DOCUMENTS

D846,839 S * 4/2019 Yim D2/889
2017/0188644 A1 * 7/2017 Foresta A42B 1/041

OTHER PUBLICATIONS

C.C Trendy Warm Chunky Soft Stretch Cable Knit Beanie, [online]; [beanie first made available at Amazon.com on Dec. 27, 2013]; [retrieved from the Internet on Sep. 20, 2019]; URL: see first page]. (4 pgs). (Year: 2013).*

* cited by examiner

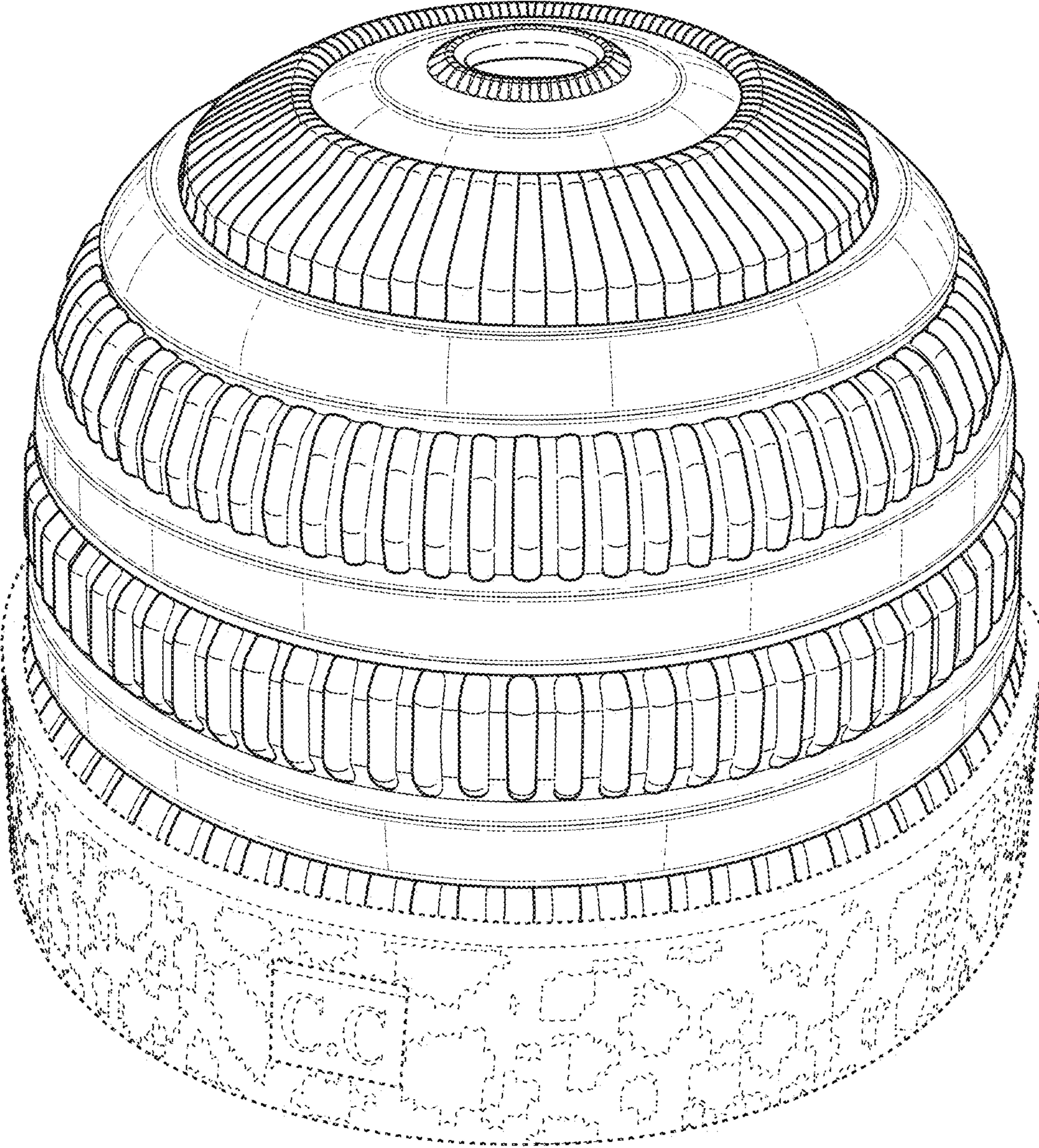

FIG. 1

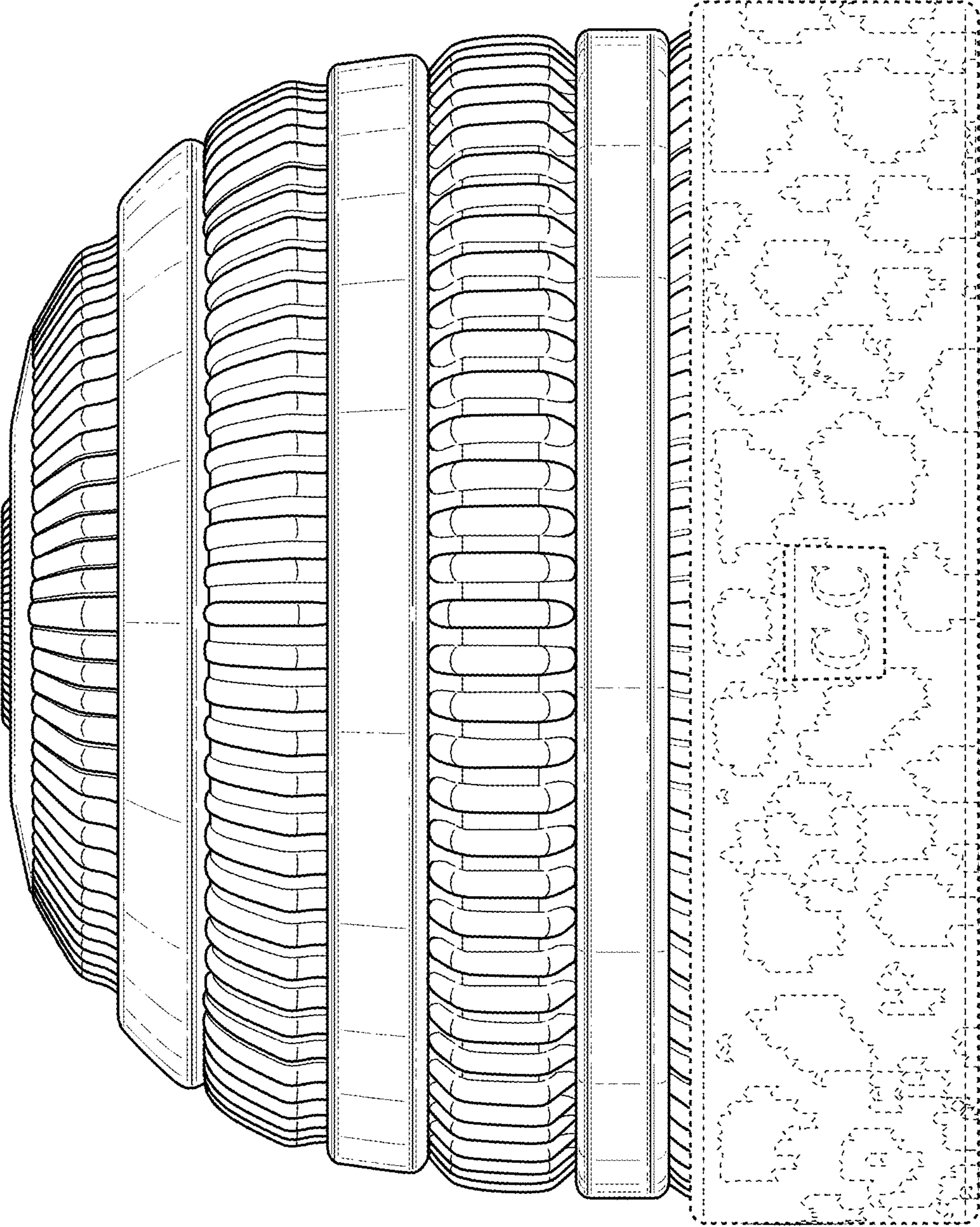

FIG. 2

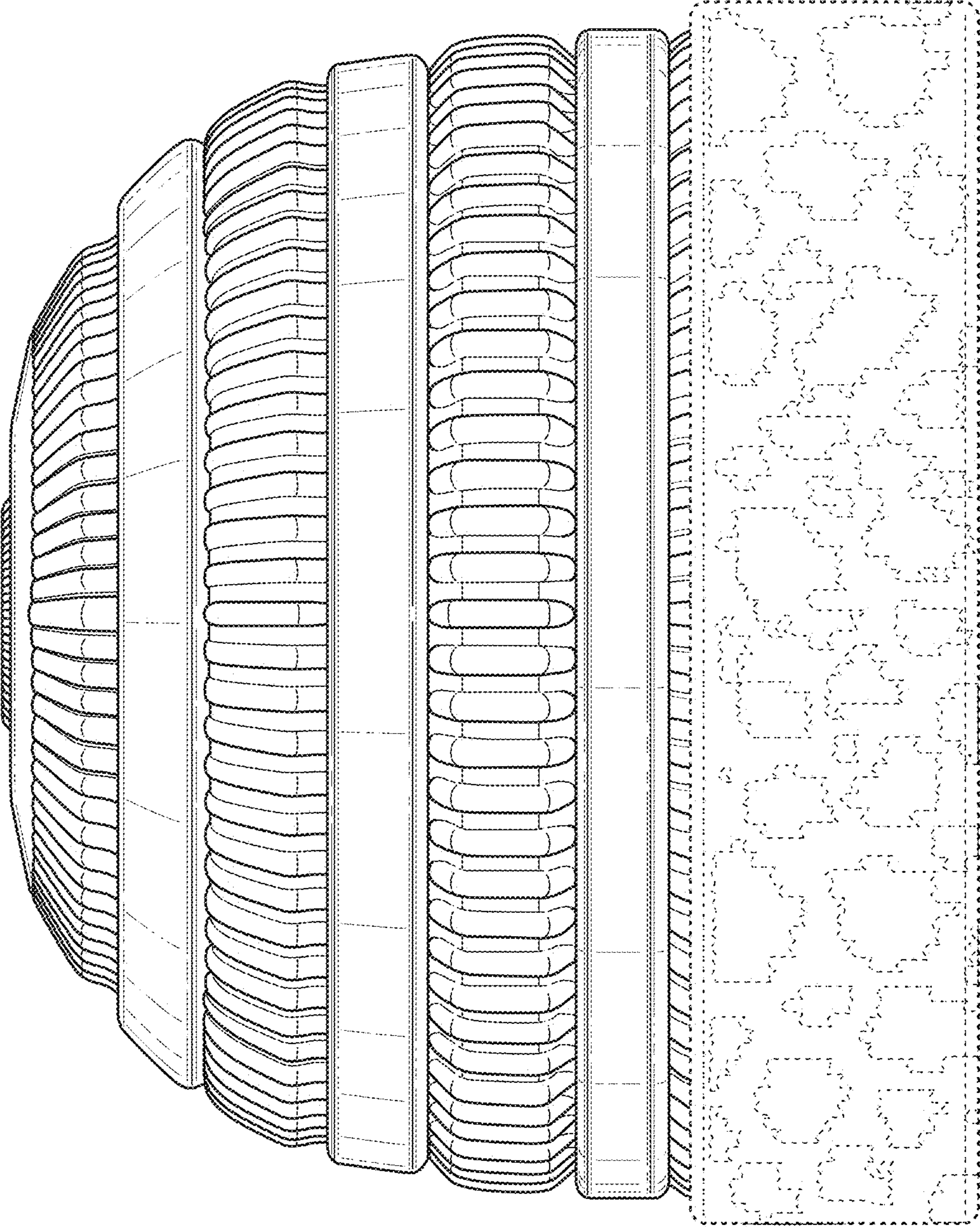

FIG. 3

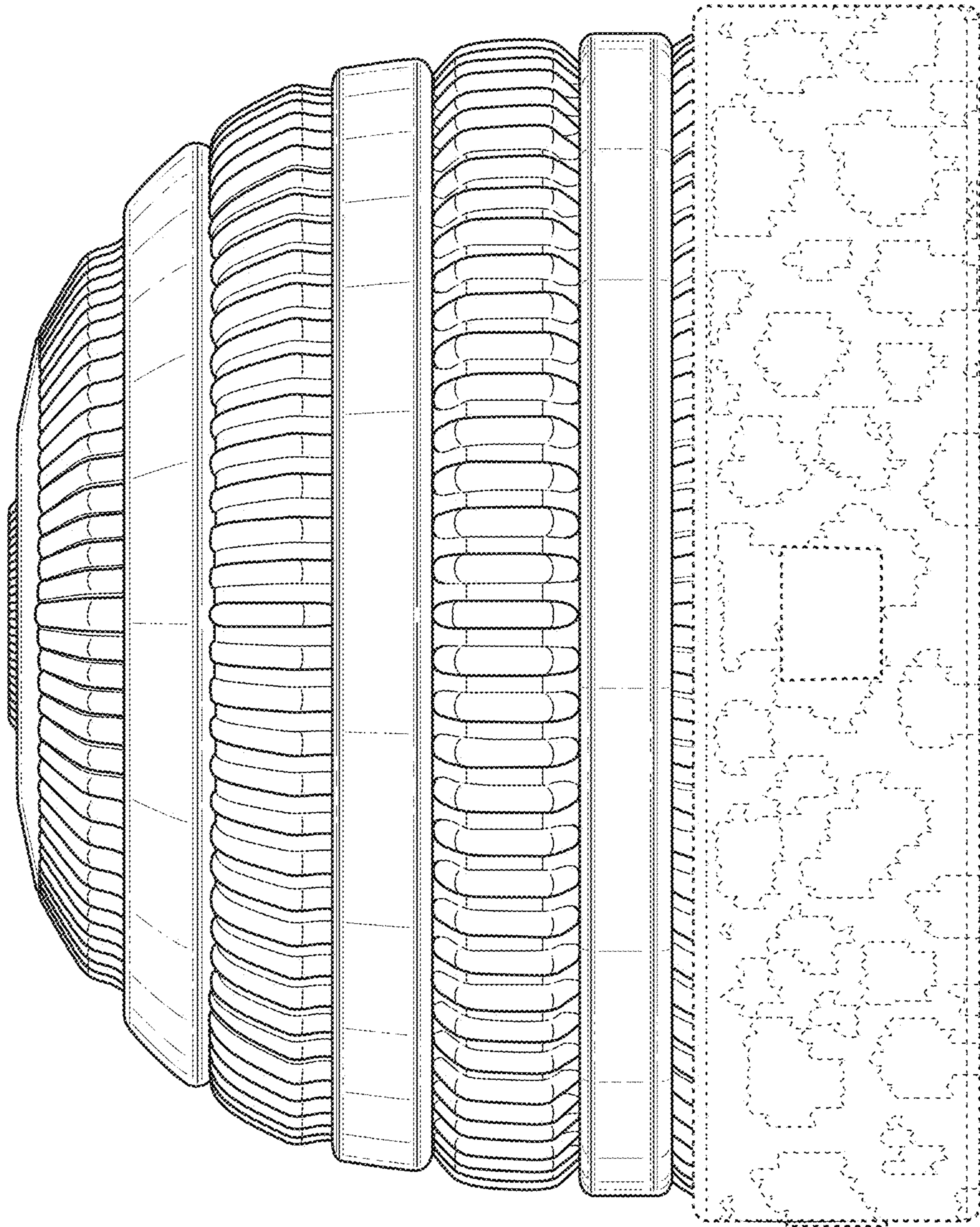

FIG. 4

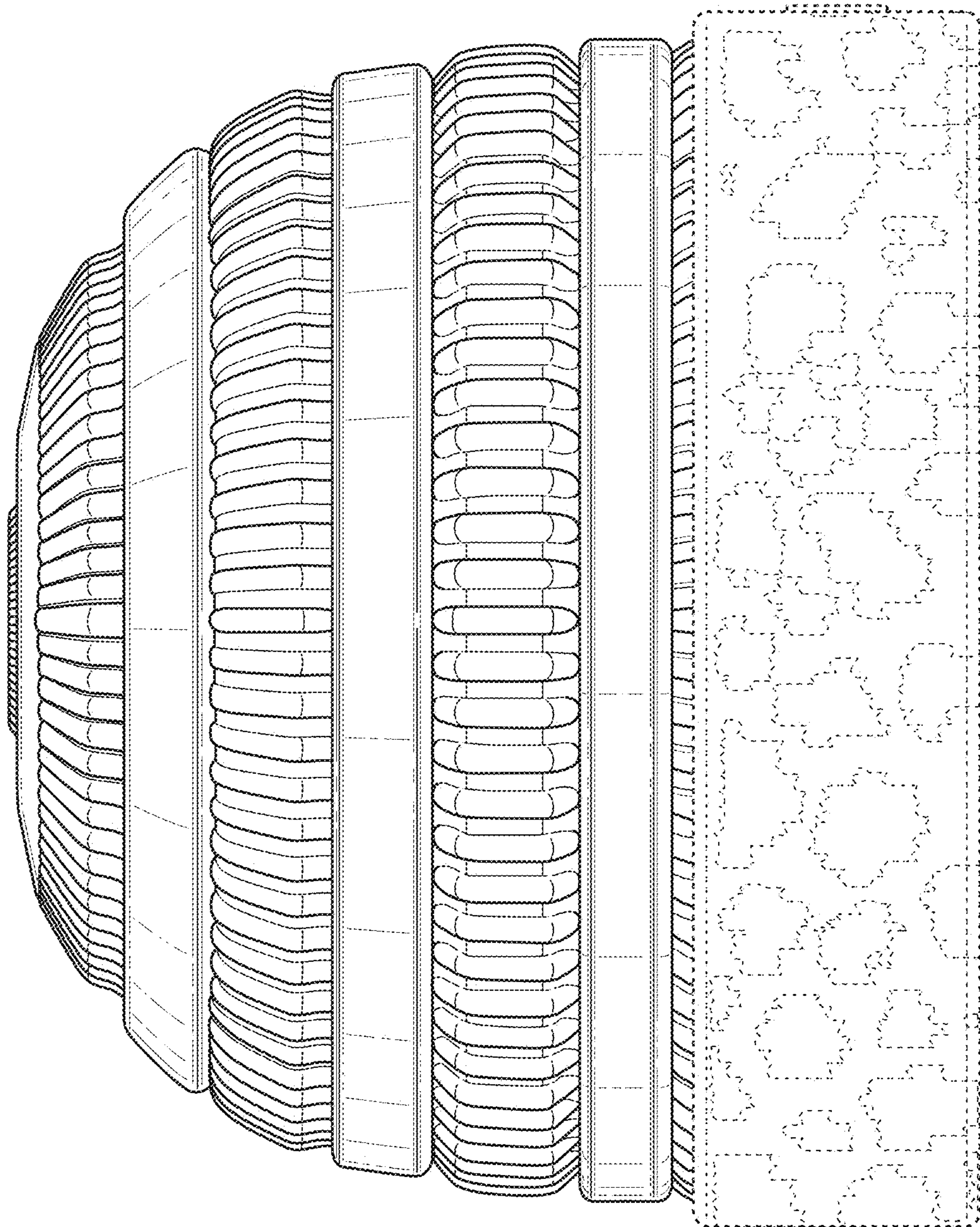

FIG. 5

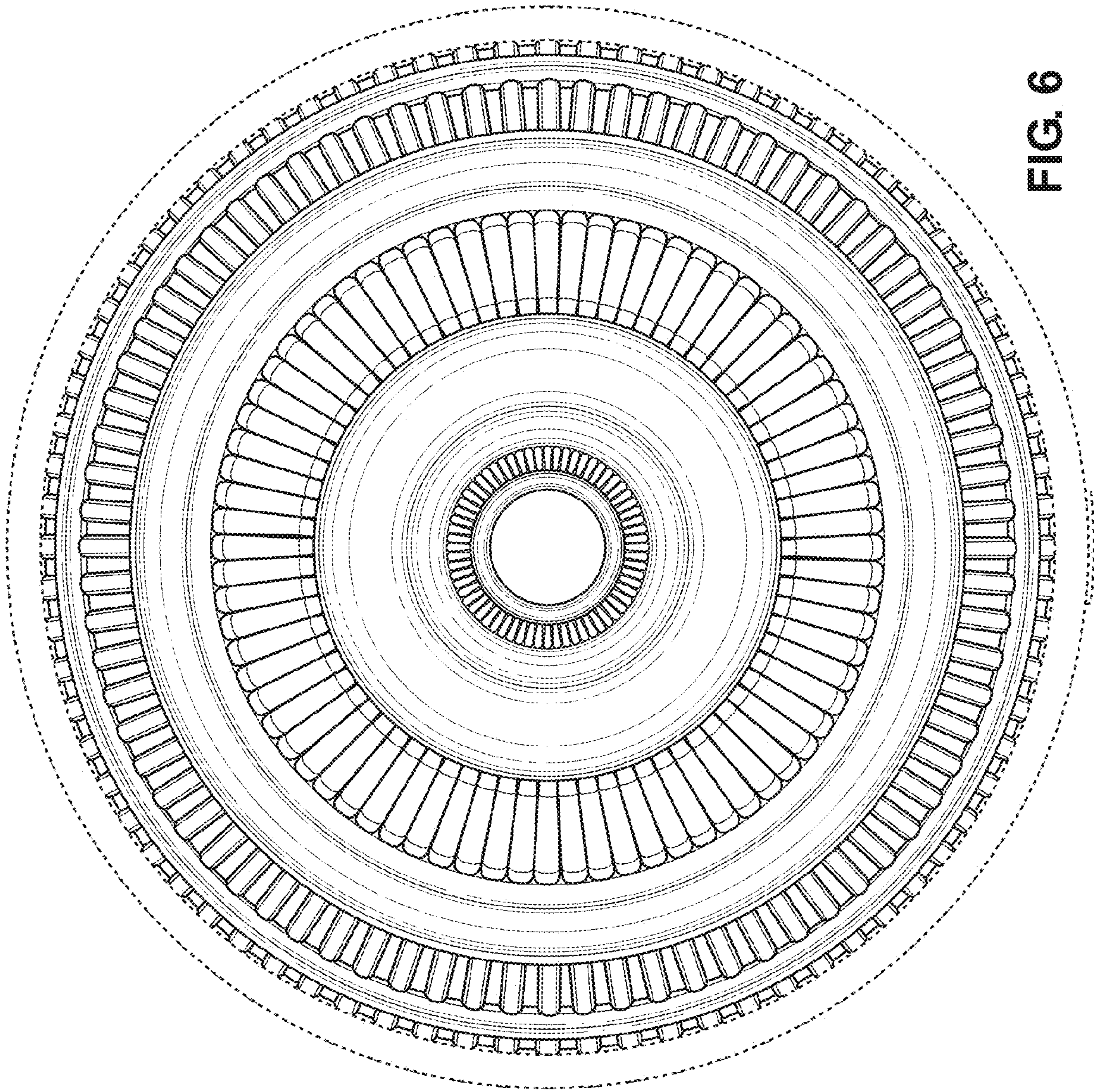

FIG. 6

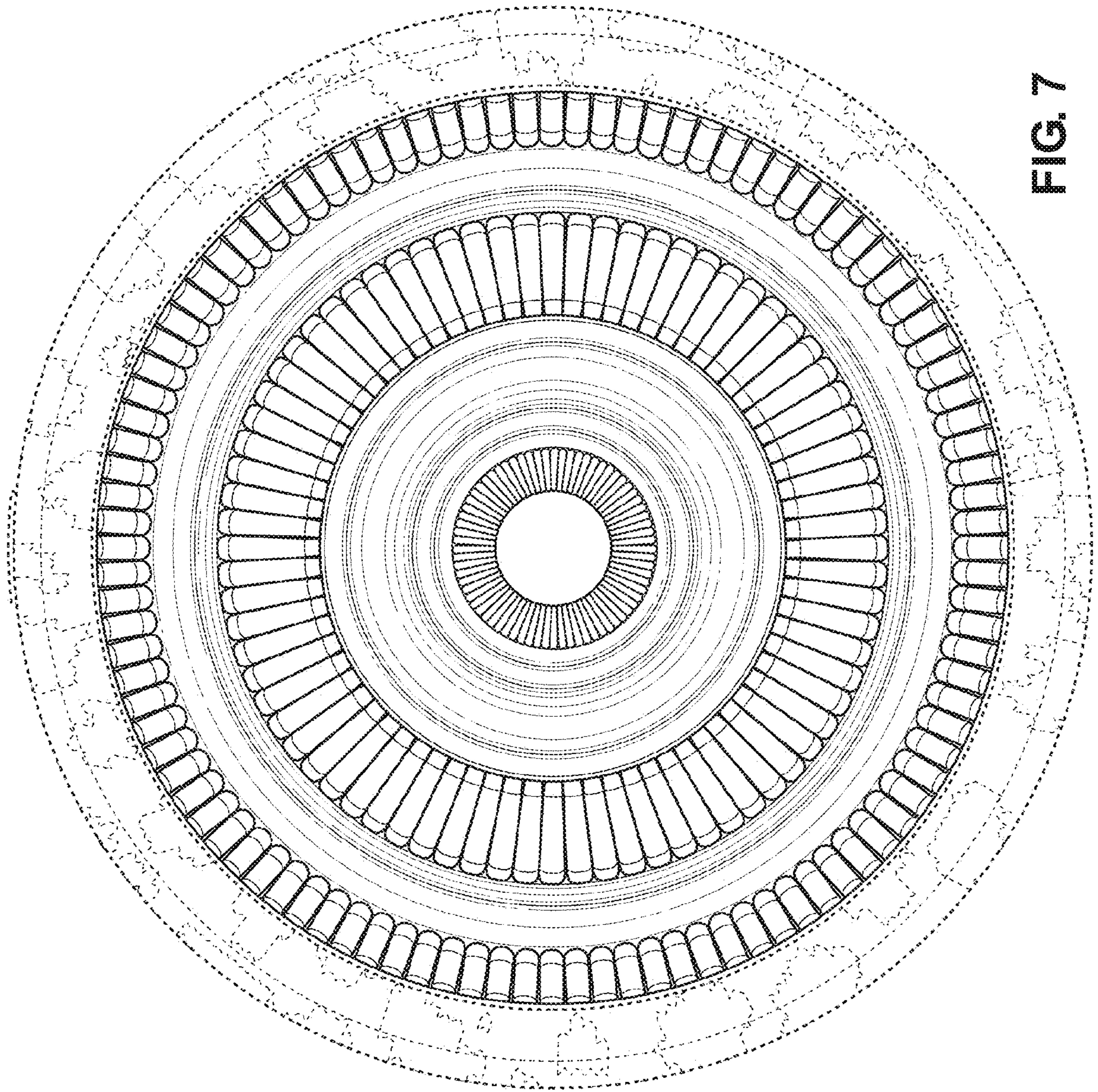

FIG. 7

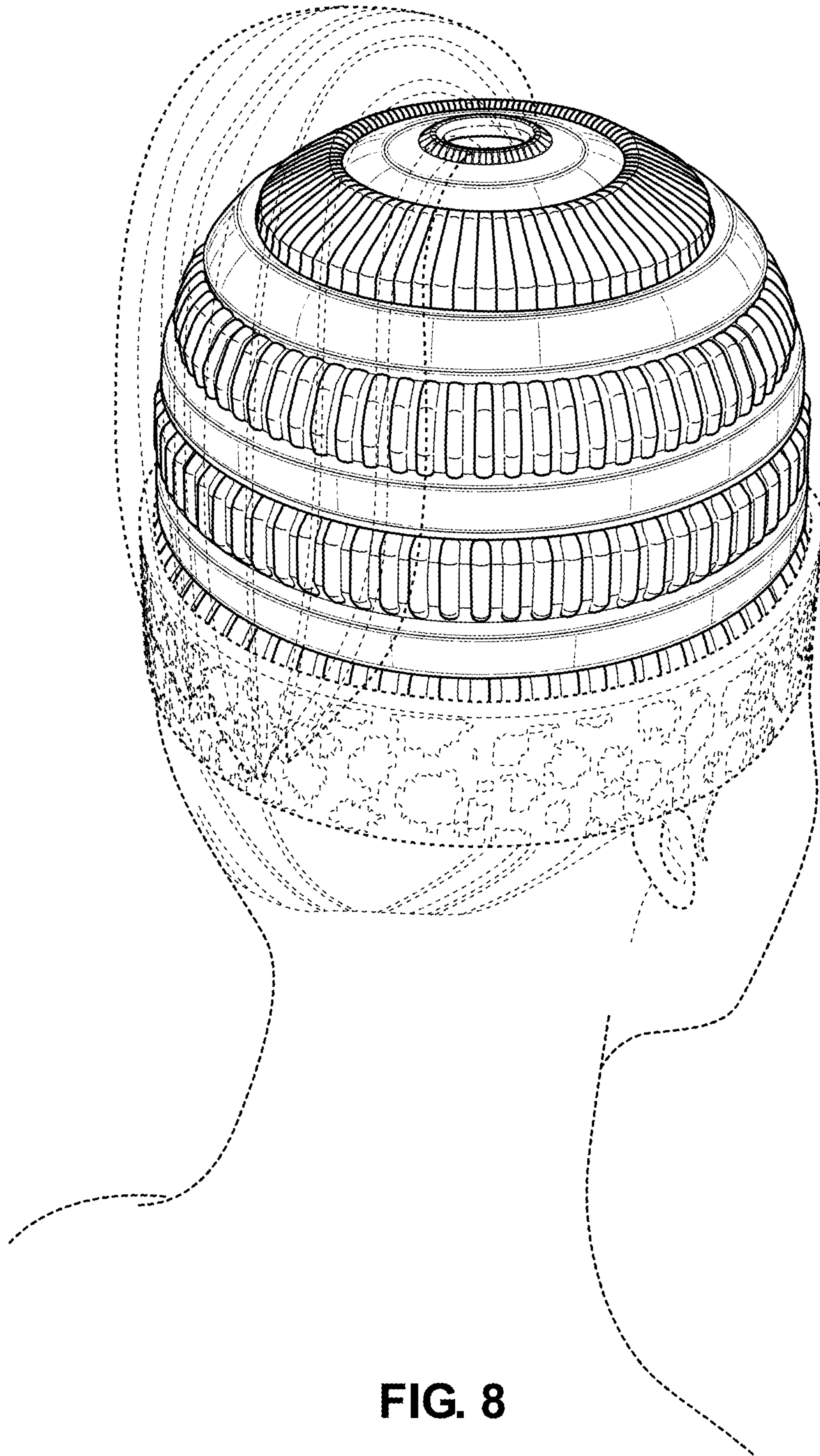

FIG. 8