



US00D892389S

(12) **United States Design Patent** (10) **Patent No.:** **US D892,389 S**
Silver (45) **Date of Patent:** **** Aug. 4, 2020**

- (54) **LUMINAIRE**
- (71) Applicant: **Beta-Calco Inc.**, Toronto (CA)
- (72) Inventor: **Remy Silver**, Toronto (CA)
- (73) Assignee: **Beta-Calco, Inc.**, Toronto (CA)
- (**) Term: **15 Years**
- (21) Appl. No.: **29/724,011**
- (22) Filed: **Feb. 12, 2020**

Related U.S. Application Data

- (62) Division of application No. 29/633,003, filed on Jan. 11, 2018.

Foreign Application Priority Data

- Aug. 11, 2017 (CA) 176404
- (51) **LOC (12) Cl.** **26-03**
- (52) **U.S. Cl.**
USPC **D26/90; D26/120**
- (58) **Field of Classification Search**
USPC ... D26/72, 85, 88, 89, 90, 91, 118, 120, 121
(Continued)

References Cited

U.S. PATENT DOCUMENTS

- D584,848 S * 1/2009 Menke D26/76
 - D599,944 S * 9/2009 Sabernig D26/74
- (Continued)

OTHER PUBLICATIONS

GARBO ceiling light from EDGE Lighting. Downloaded from edgelighting.com Feb. 26, 2009. (Year: 2009).*

(Continued)

Primary Examiner — Clare E Heflin

(74) *Attorney, Agent, or Firm* — Renner, Otto, Boisselle & Sklar, LLP

(57) **CLAIM**

The ornamental design for a luminaire, as shown and described.

DESCRIPTION

FIG. 1 is a bottom perspective view of a luminaire showing a first variant of the design;
 FIG. 2 is a front view thereof;
 FIG. 3 is a side view thereof;
 FIG. 4 is a bottom view thereof;
 FIG. 5 is a top view thereof;
 FIG. 6 is a top perspective view thereof;
 FIG. 7 is a bottom perspective view of a luminaire showing a second variant of the design;
 FIG. 8 is a front view thereof;
 FIG. 9 is a side view thereof;
 FIG. 10 is a bottom view thereof;
 FIG. 11 is a top view thereof;
 FIG. 12 is a top perspective view thereof;
 FIG. 13 is a bottom perspective view of a luminaire showing a third variant of the design;
 FIG. 14 is a front view thereof;
 FIG. 15 is a side view thereof;
 FIG. 16 is a bottom view thereof;
 FIG. 17 is a top view thereof;
 FIG. 18 is a top perspective view thereof;
 FIG. 19 is a bottom perspective view of a luminaire showing a fourth variant of the design;
 FIG. 20 is a front view thereof;
 FIG. 21 is a side view thereof;
 FIG. 22 is a bottom view thereof;
 FIG. 23 is a top view thereof; and,
 FIG. 24 is a top perspective view thereof.

The portions of the luminaire shown in broken lines form no part of the design. The thin diagonal lines indicate translucency.

1 Claim, 4 Drawing Sheets

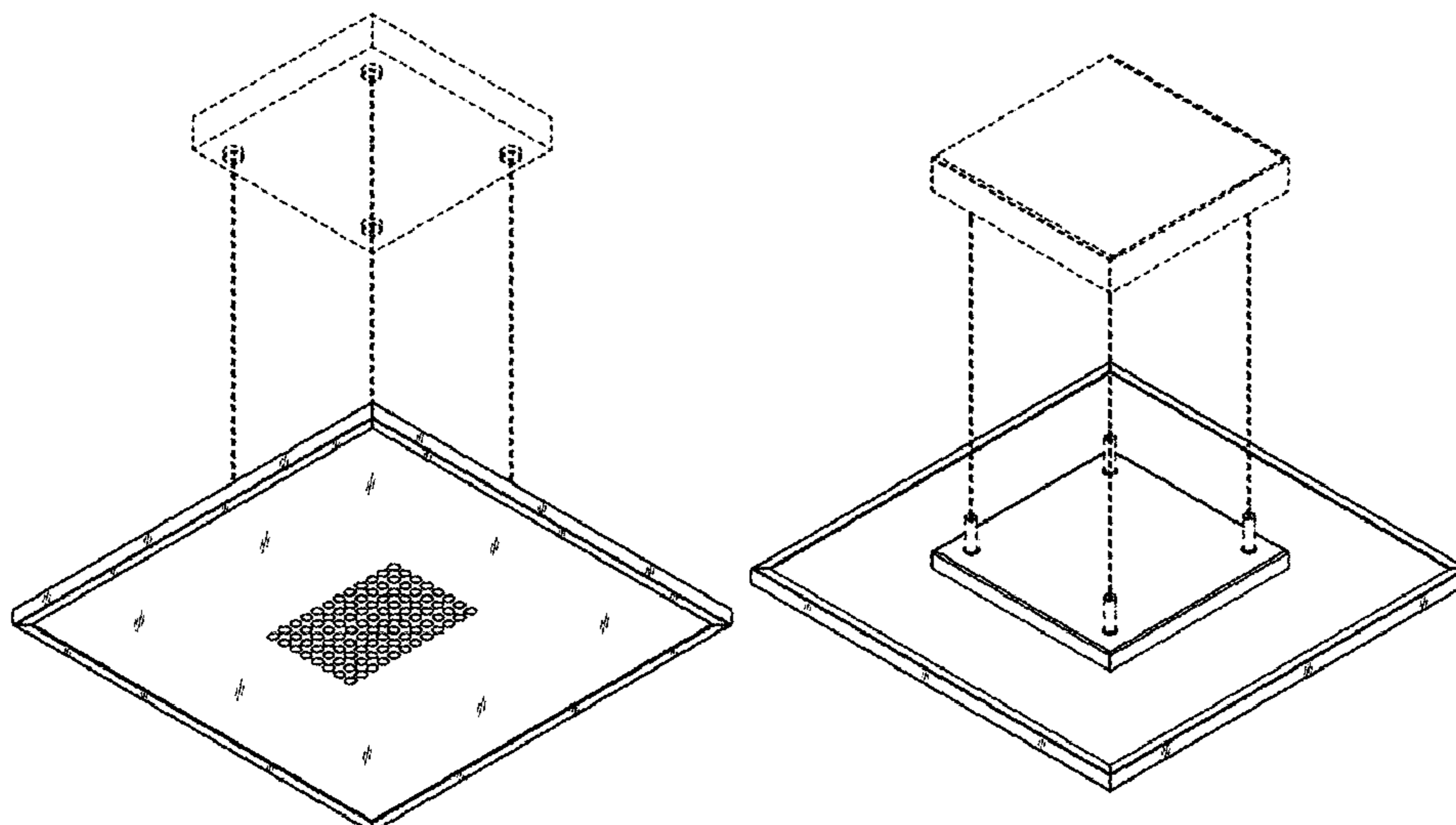

(58) **Field of Classification Search**
 CPC F21S 8/04; F21S 8/043; F21S 8/046; F21S
 8/06; F21S 8/063; F21S 8/065; F21S
 8/068
 See application file for complete search history.

2007/0064444 A1* 3/2007 Kim G02B 6/0031
 362/612
 2013/0044480 A1* 2/2013 Sato F21S 8/061
 362/235
 2013/0182417 A1* 7/2013 Amat Girbau A61B 90/35
 362/147
 2014/0211457 A1* 7/2014 Tarsa F21S 8/06
 362/147

(56) **References Cited**

U.S. PATENT DOCUMENTS

D603,083 S * 10/2009 Trumble D26/90
 7,766,536 B2 * 8/2010 Peifer F21S 8/00
 362/155
 D628,335 S * 11/2010 Hyland D26/74
 D636,923 S * 4/2011 De Bevilacqua D26/85
 D668,371 S * 10/2012 Alpaslan D26/72
 D746,504 S * 12/2015 Sabernig D26/85
 D819,860 S * 6/2018 Clark D26/76
 D831,262 S * 10/2018 Amato D26/88
 D844,884 S * 4/2019 Giacobone D26/90
 2006/0109688 A1* 5/2006 Oosawa G02B 6/0086
 362/632
 2006/0237735 A1* 10/2006 Naulin H01L 33/641
 257/98
 2006/0285358 A1* 12/2006 Chen G09F 13/04
 362/613

OTHER PUBLICATIONS

4x4 wall sconce from EDGE Lighting. Downloaded from edgelighting.com Feb. 26, 2009. (Year: 2009).*

VIEW surface mounted wall fixture from EDGE Lighting. Downloaded from edgelighting.com Feb. 26, 2009. (Year: 2009).*

FRAME recessed wall fixture from EDGE Lighting. Downloaded from edgelighting.com Feb. 26, 2009. (Year: 2009).*

PLAZA SMALL surface mounted wall fixture from EDGE Lighting. Downloaded from edgelighting.com Feb. 26, 2009. (Year: 2009).*

LED Power Supply from EDGE Lighting. Downloaded from edgelighting.com Feb. 26, 2009. (Year: 2009).*

* cited by examiner

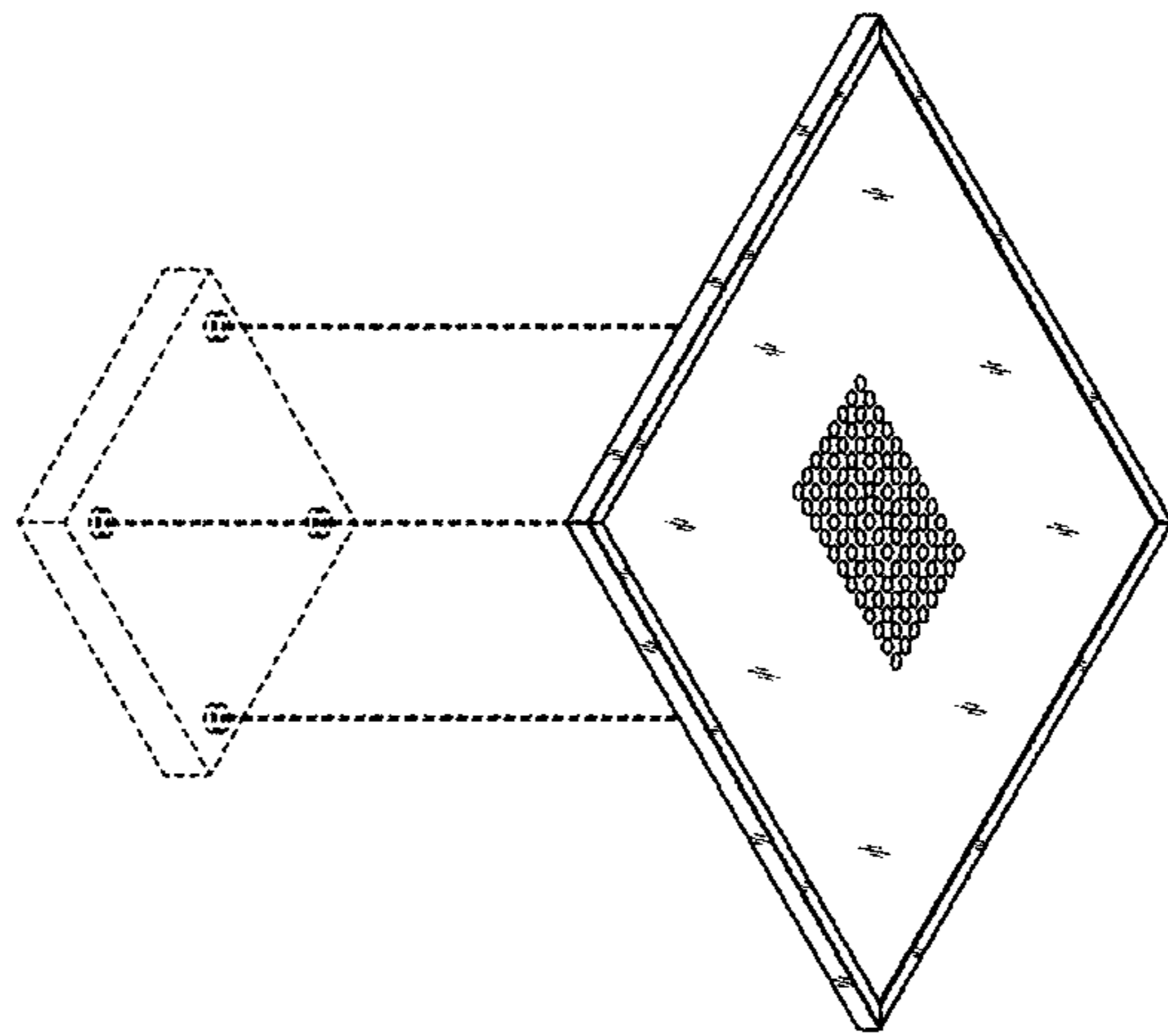

FIG. 1

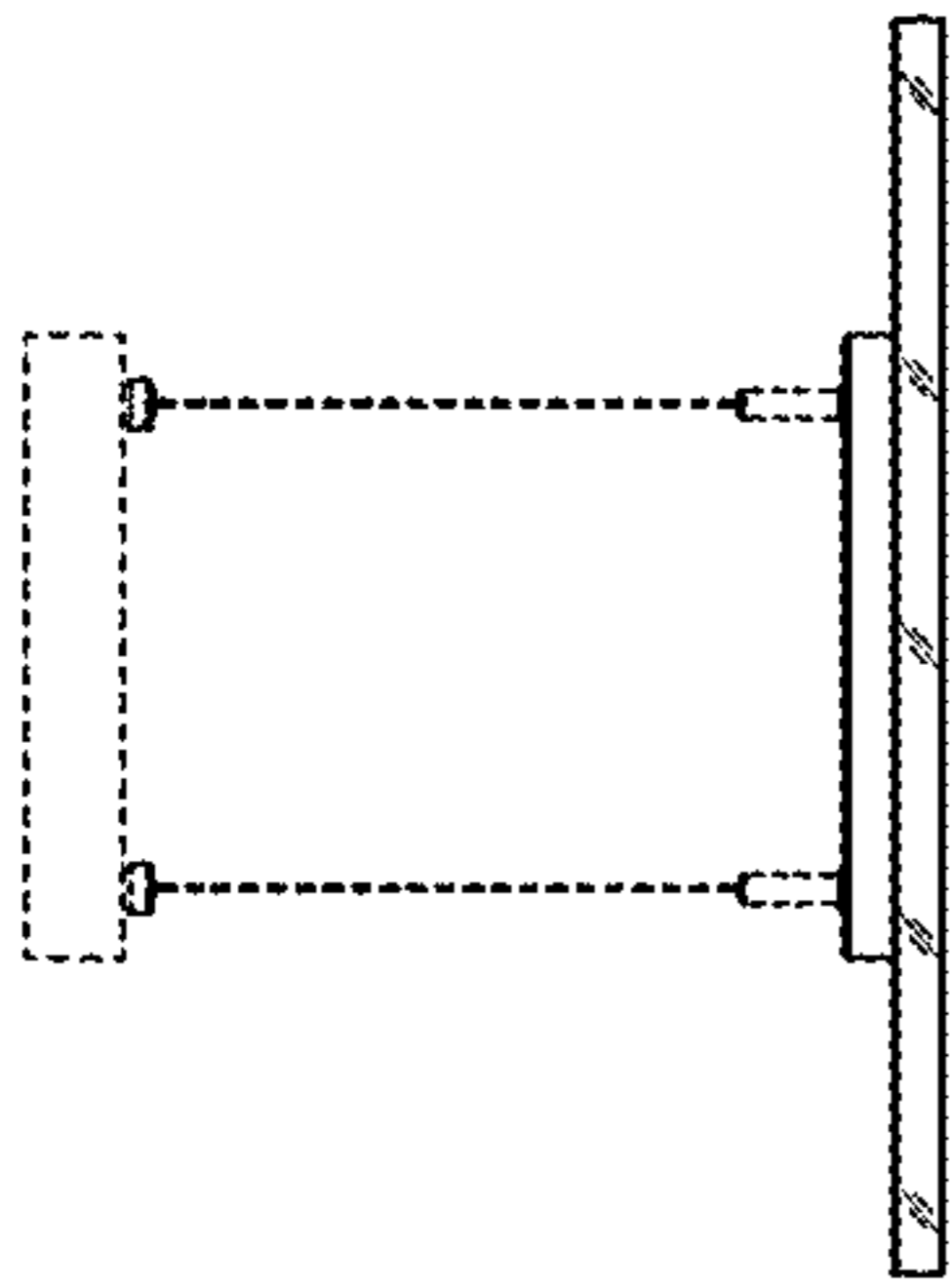

FIG. 2

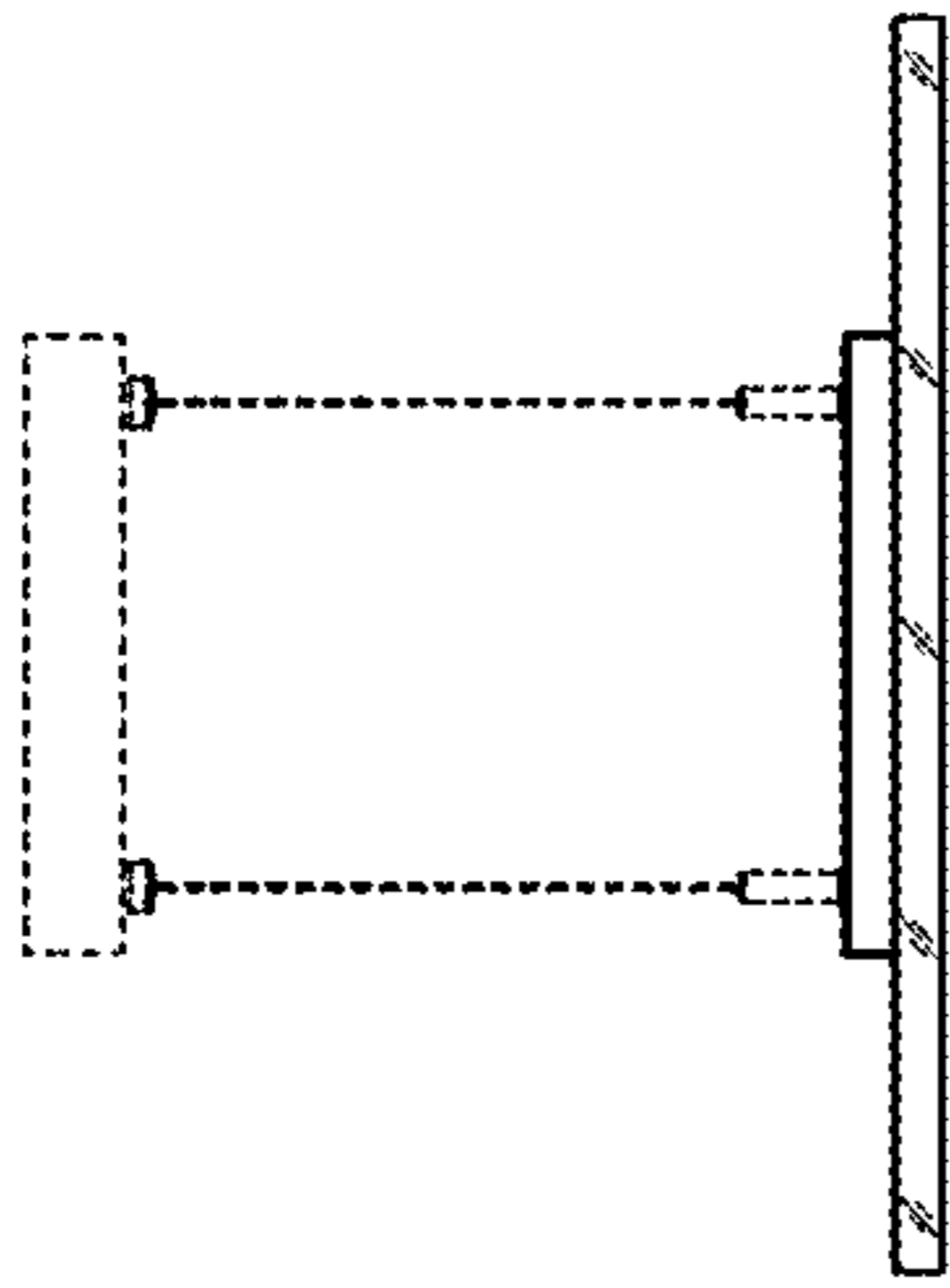

FIG. 3

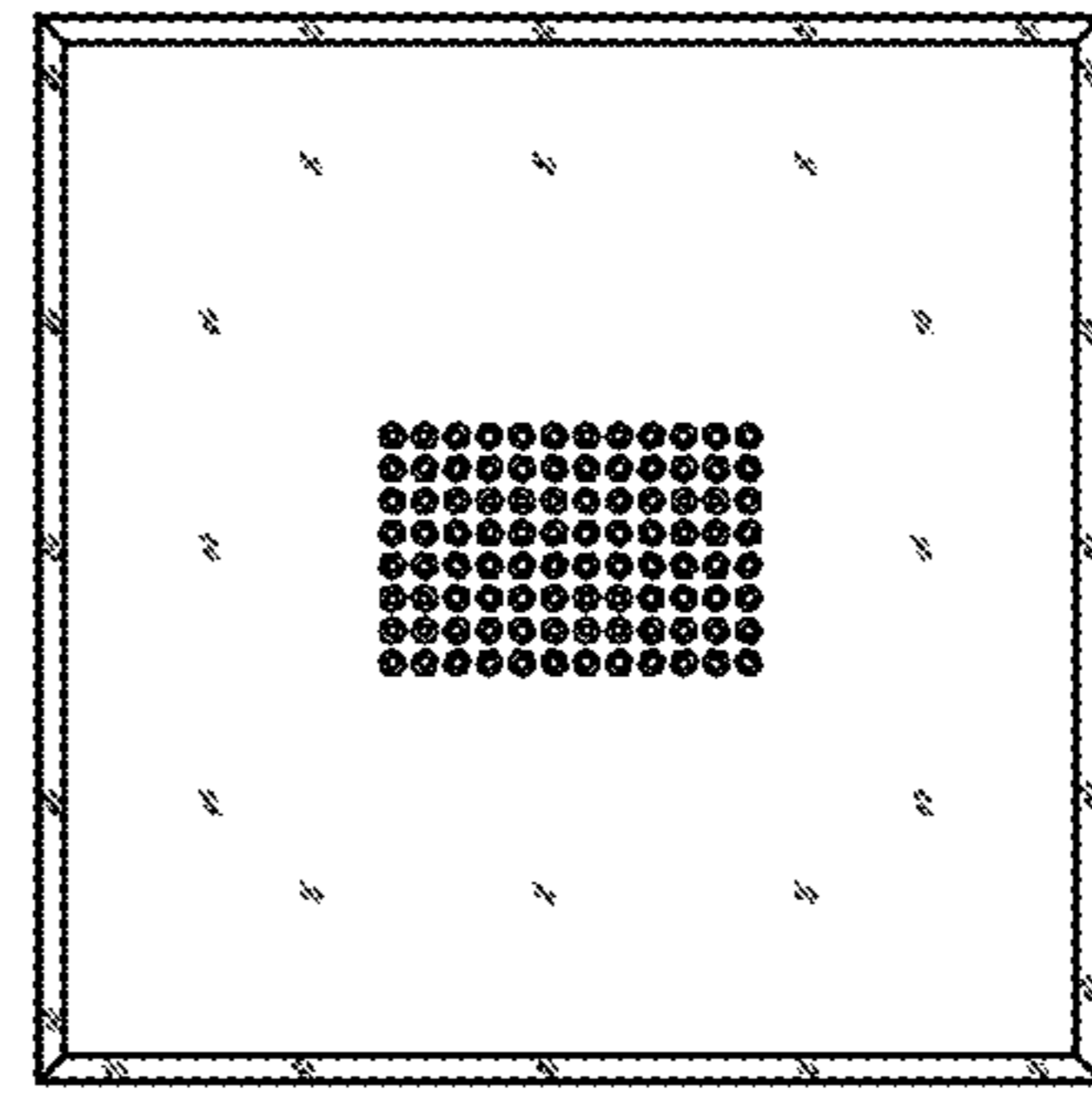

FIG. 4

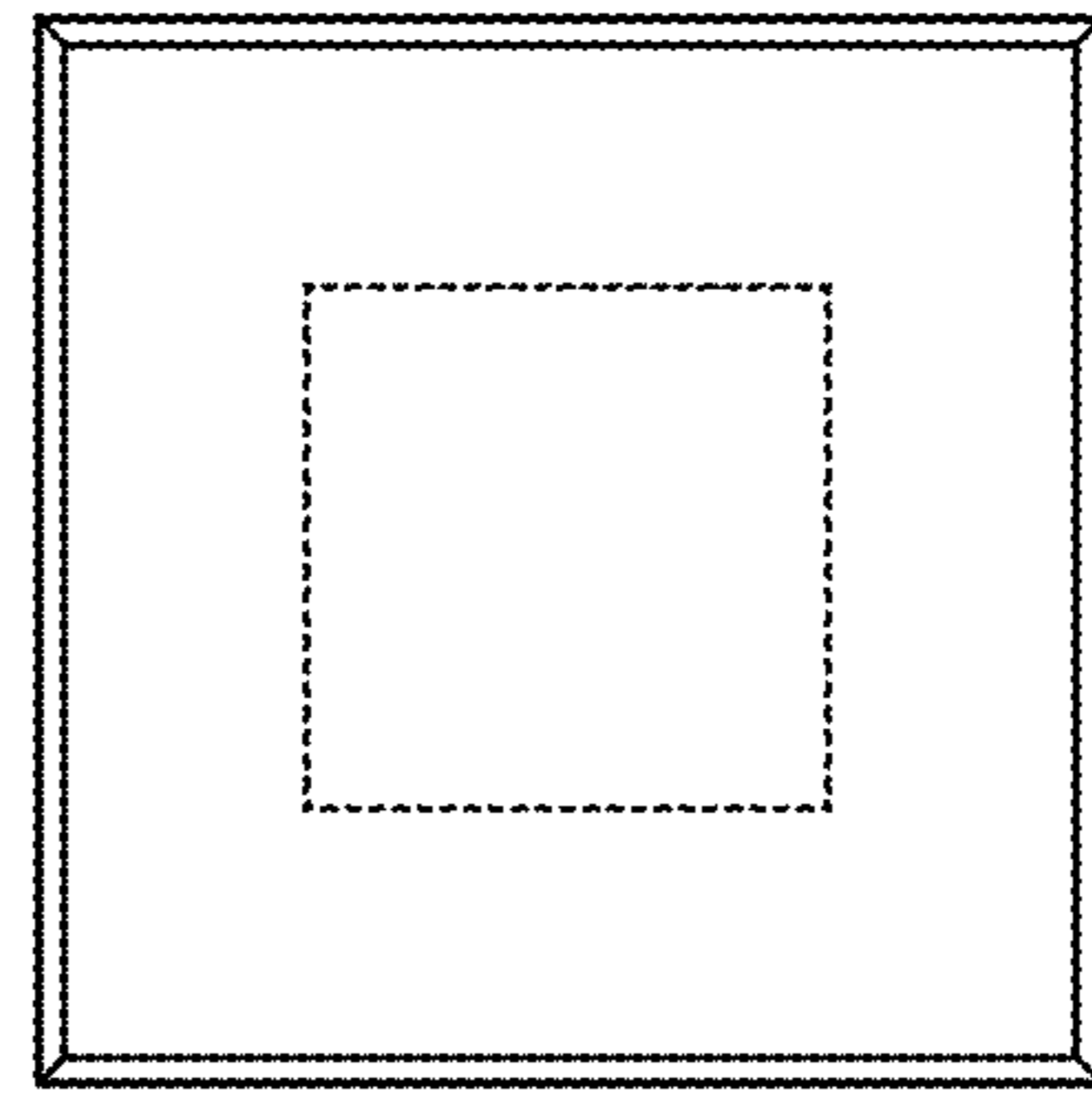

FIG. 5

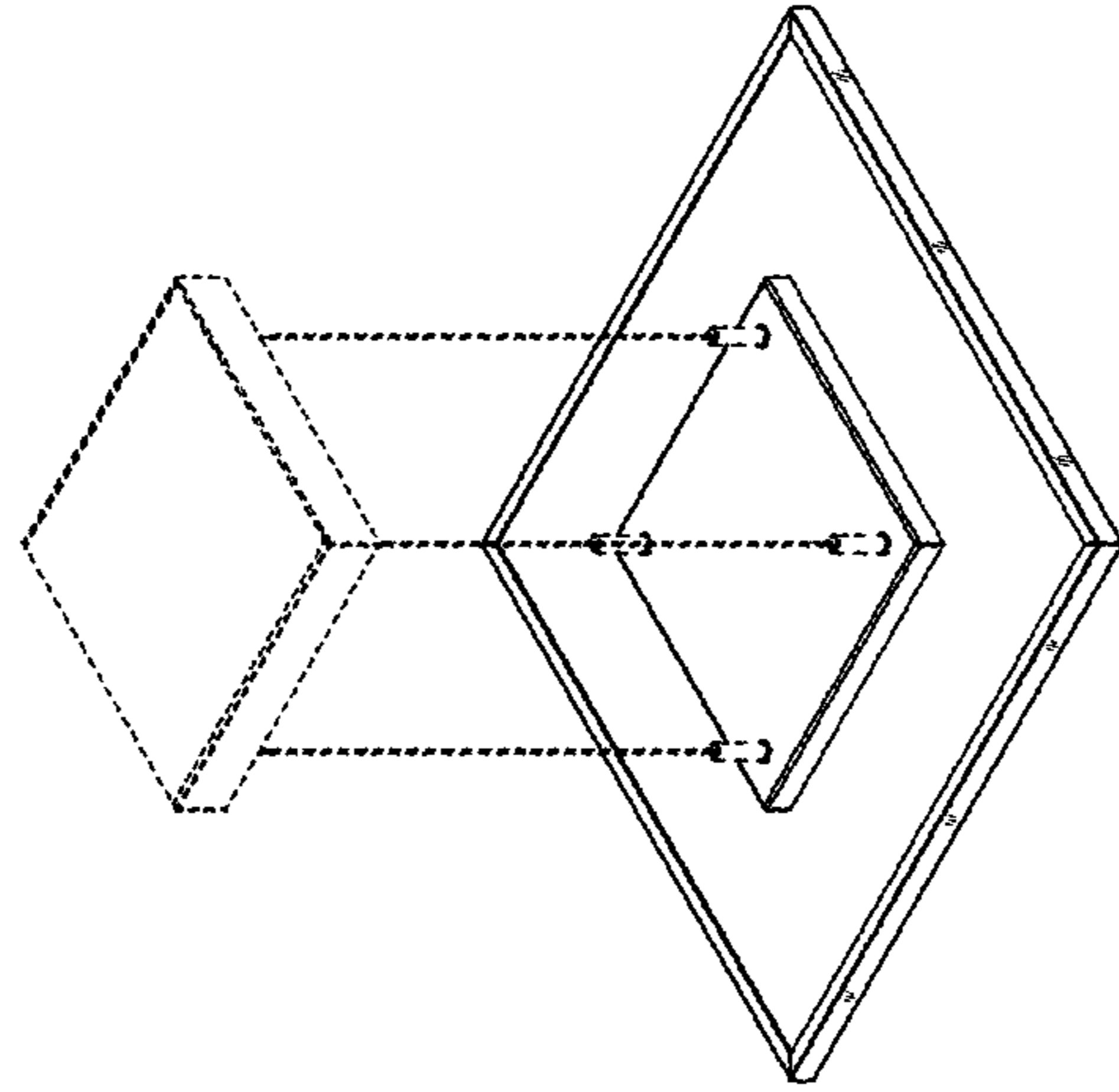

FIG. 6

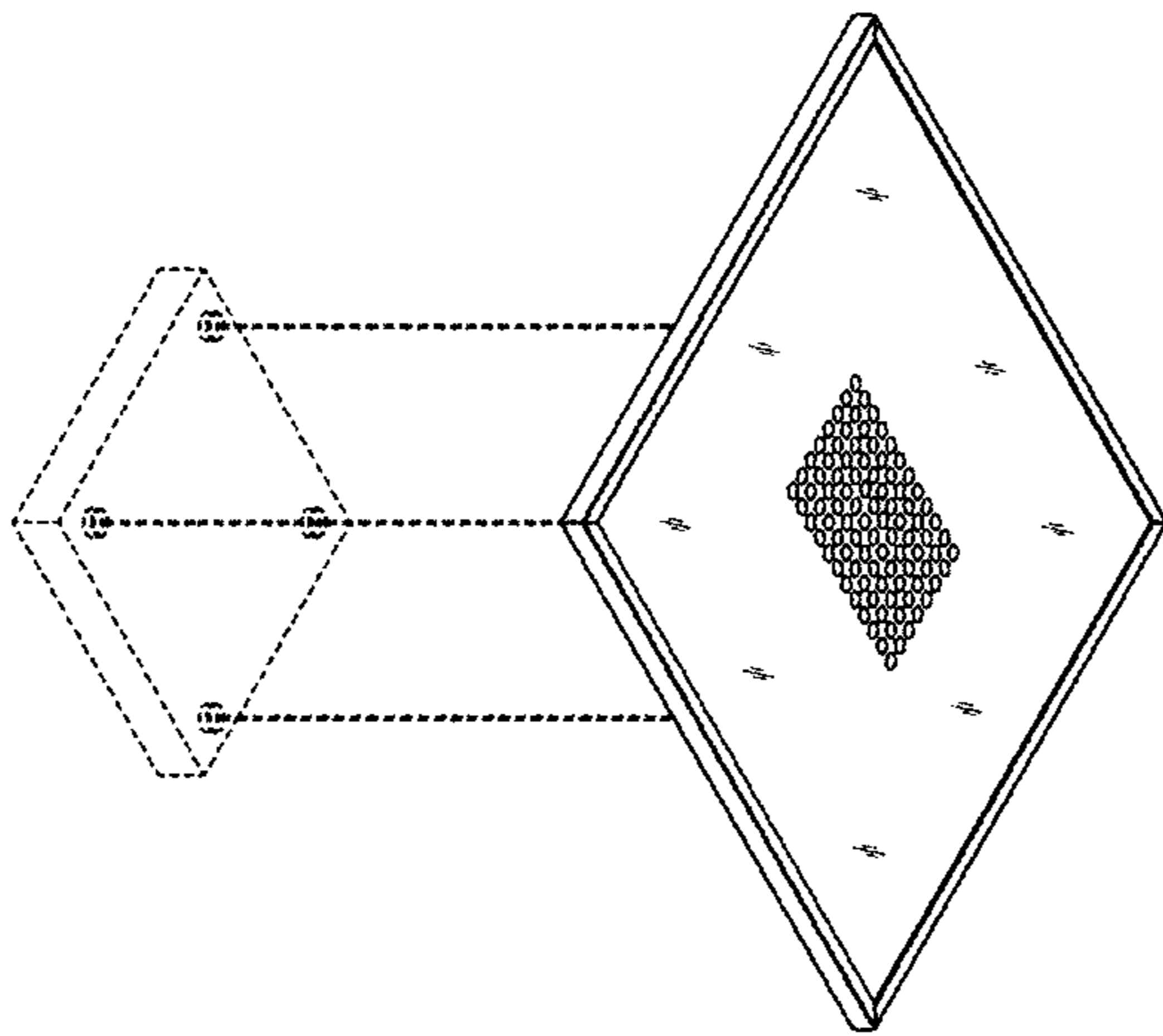

FIG. 7

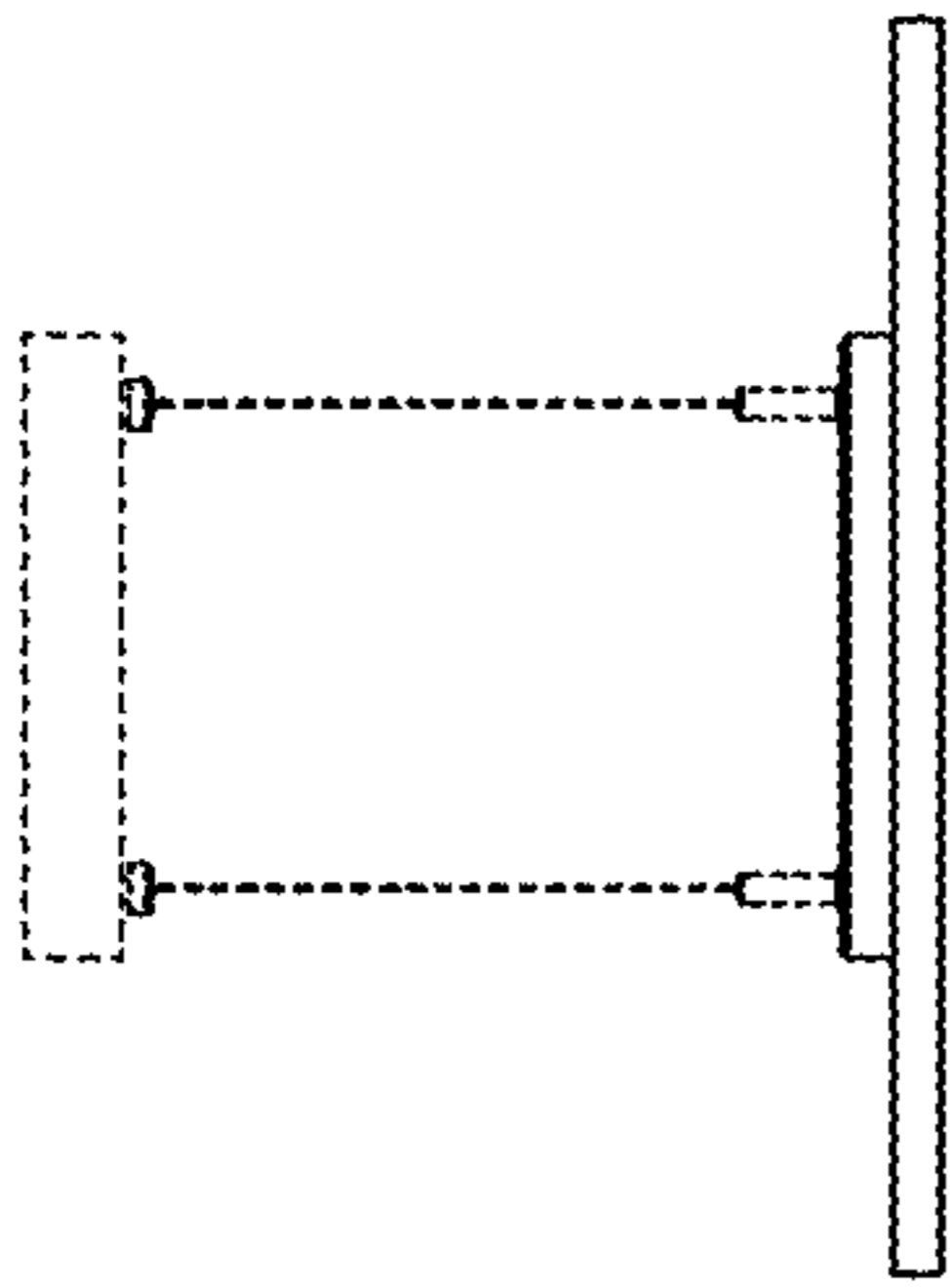

FIG. 8

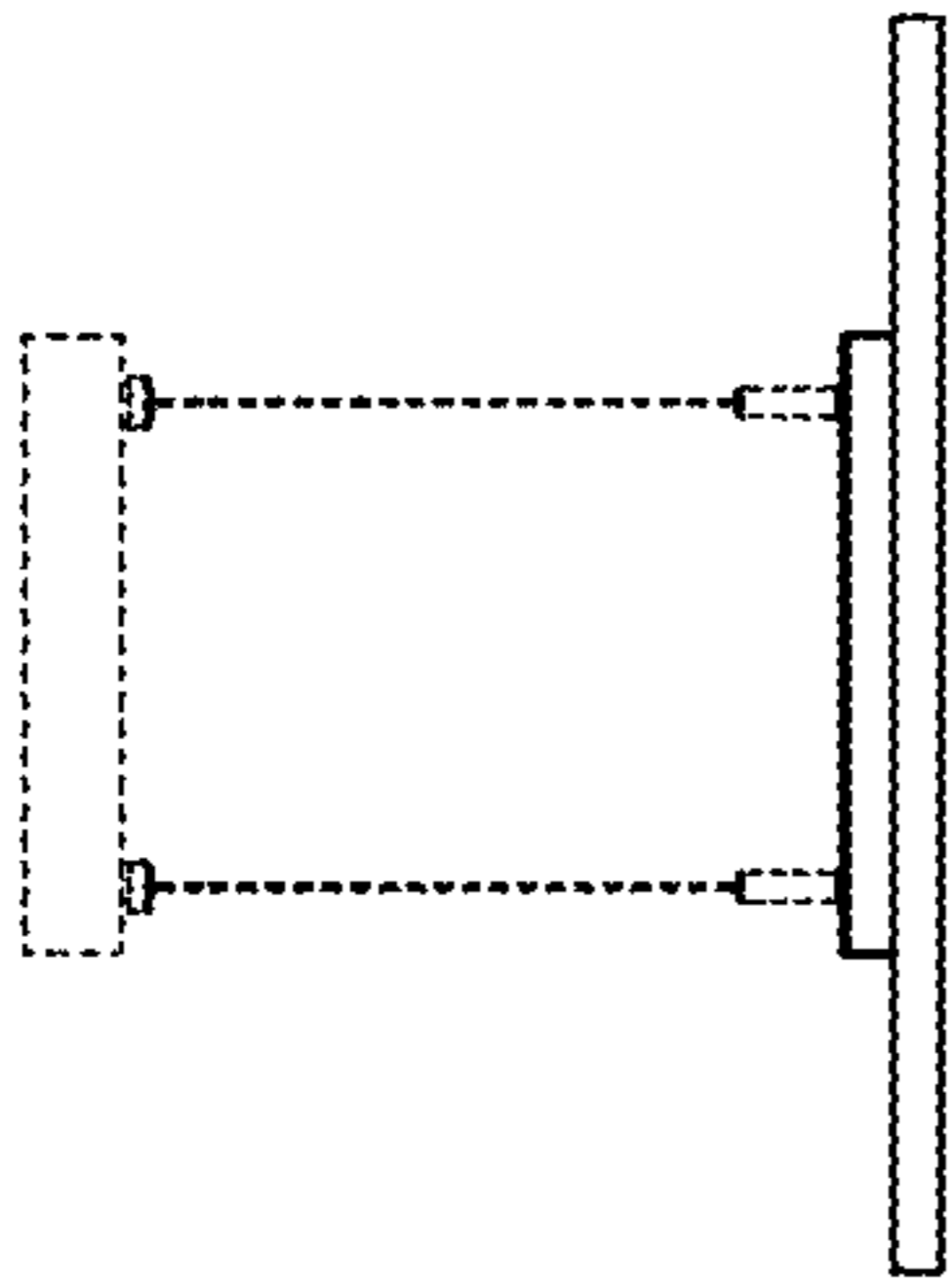

FIG. 9

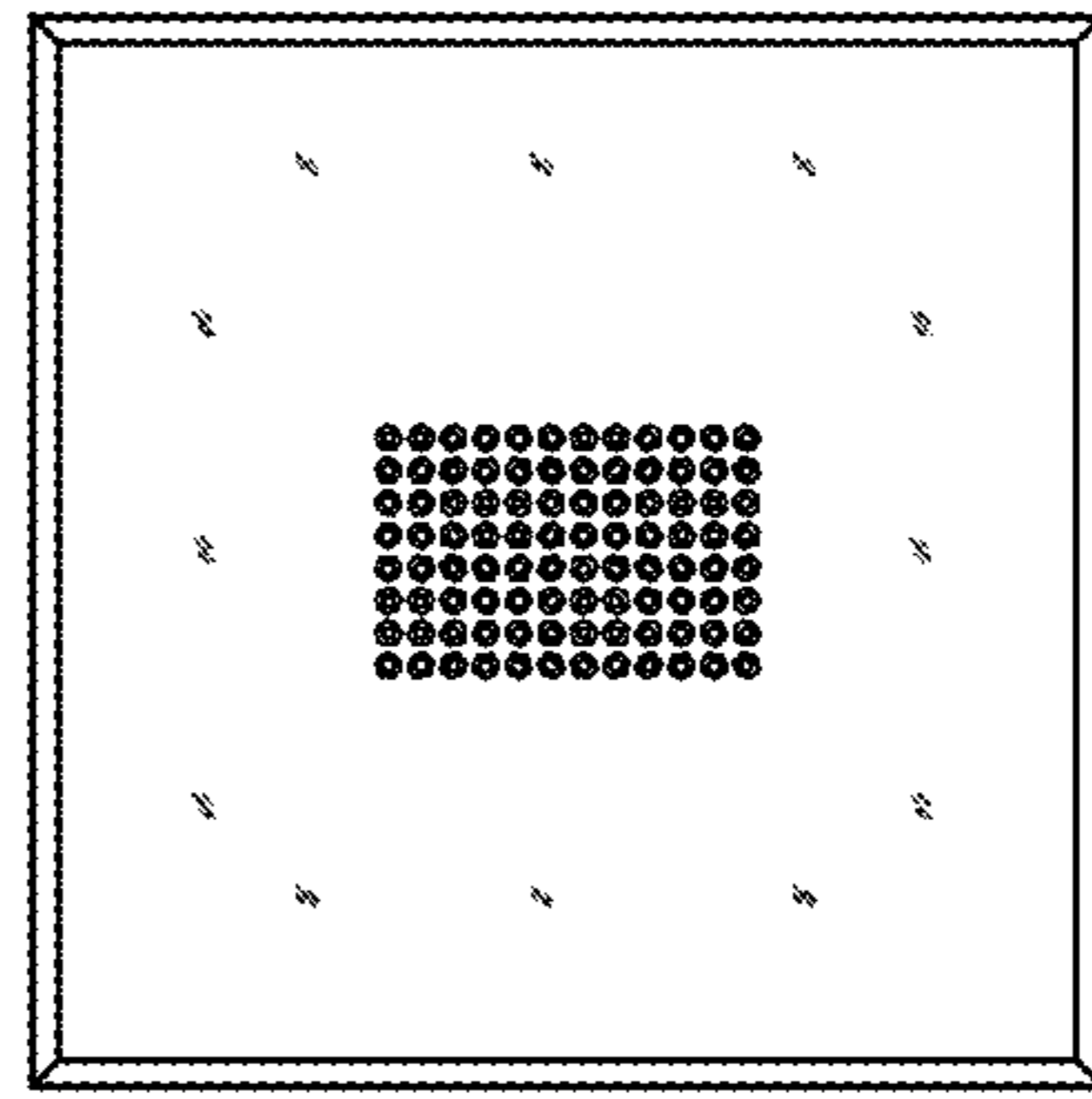

FIG. 10

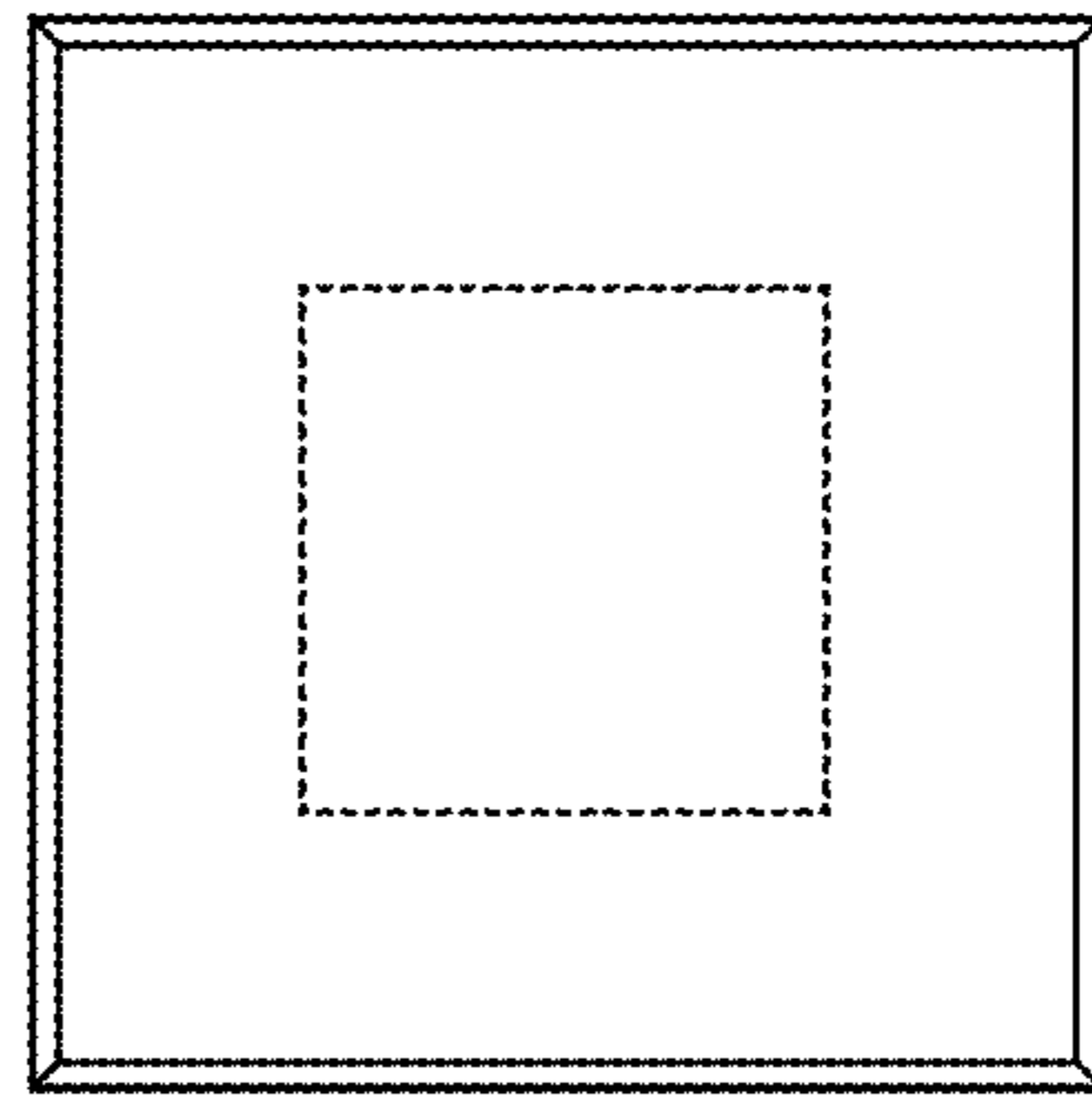

FIG. 11

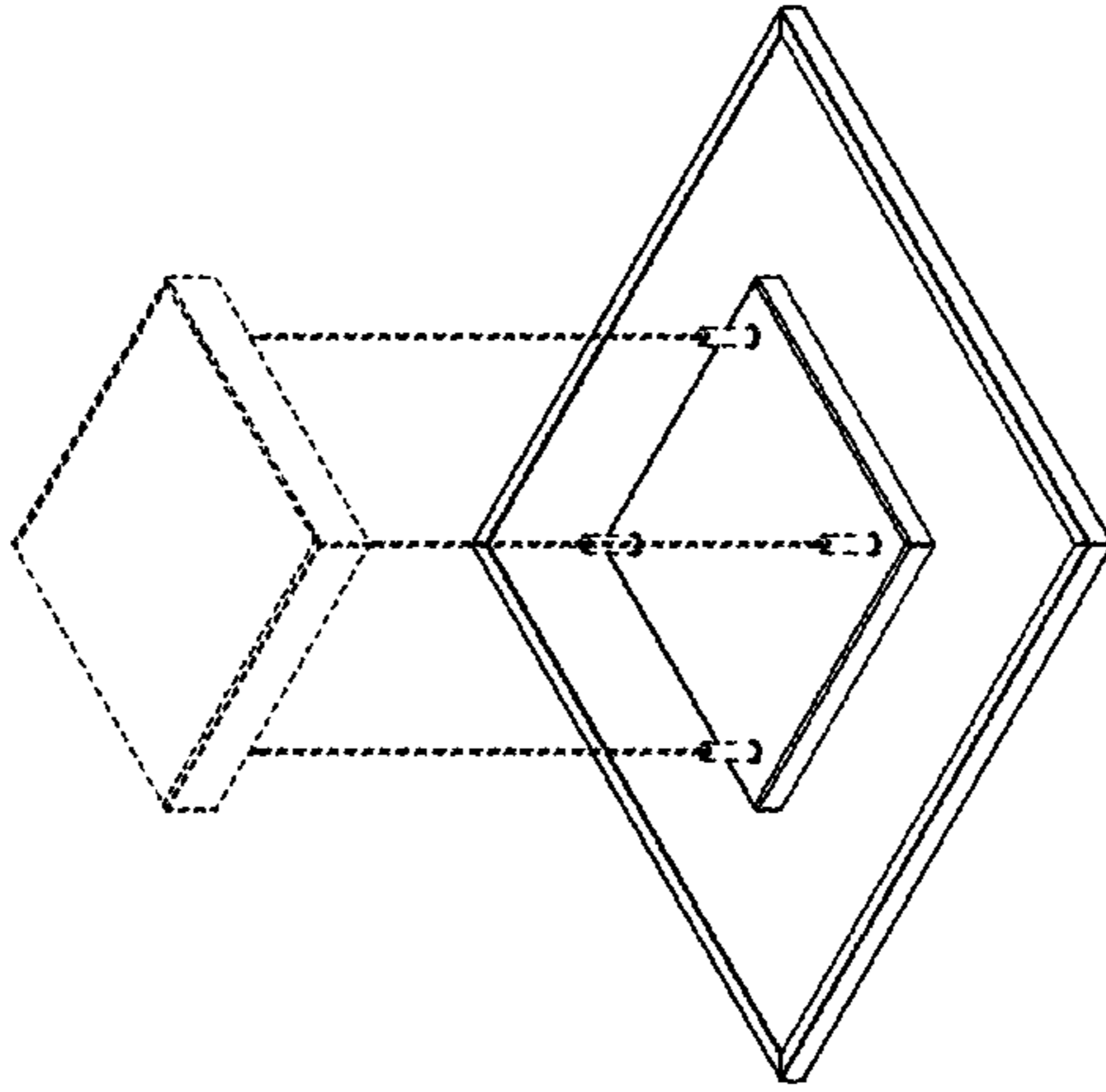

FIG. 12

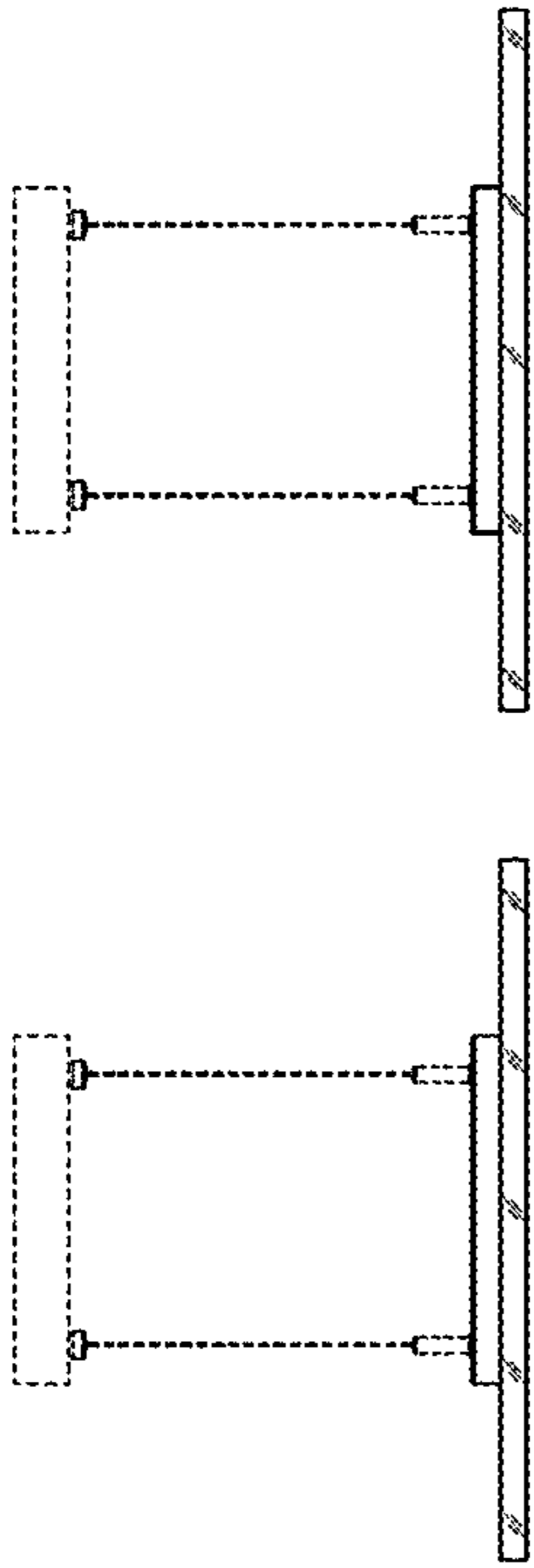

FIG. 14

FIG. 15

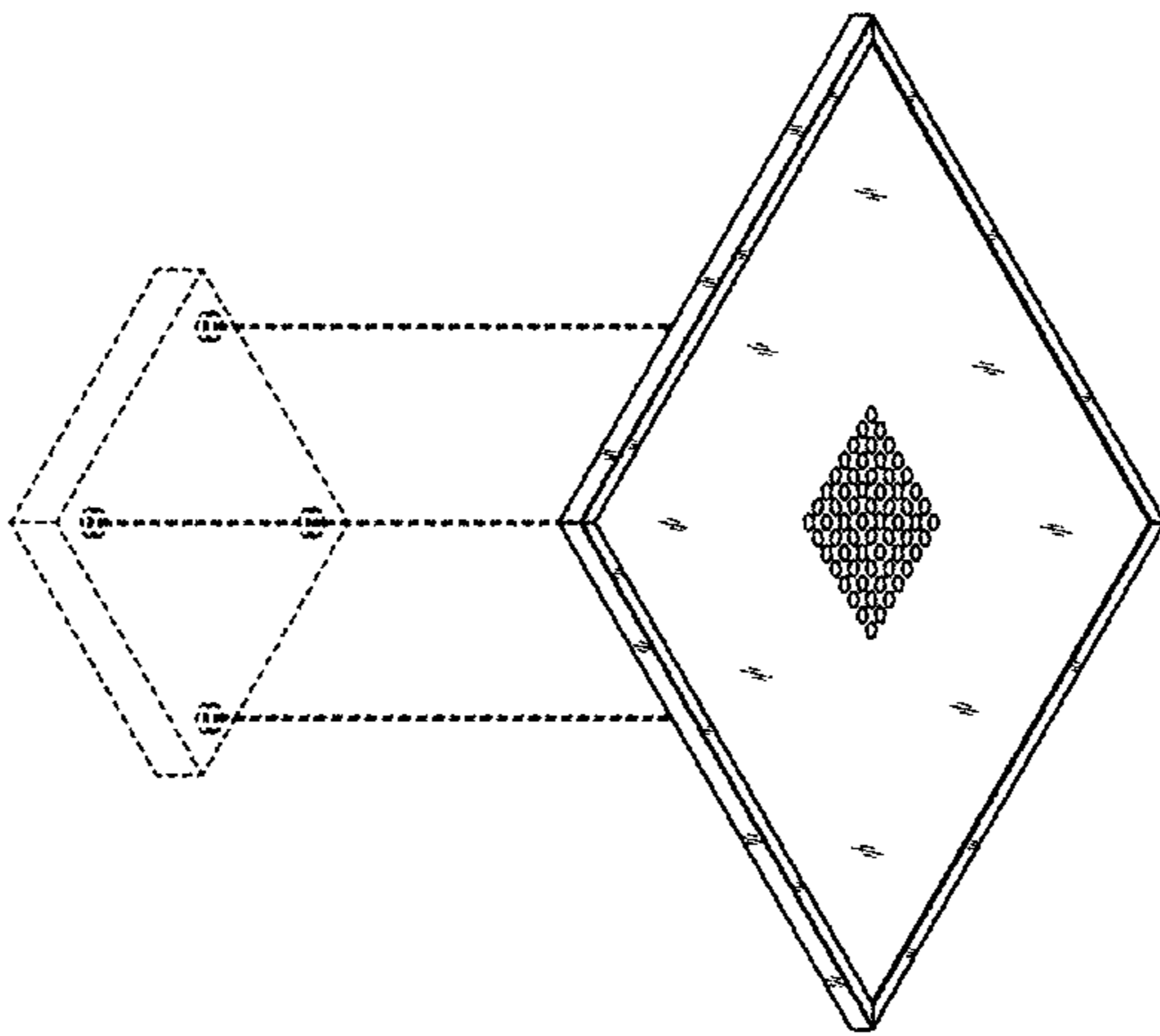

FIG. 13

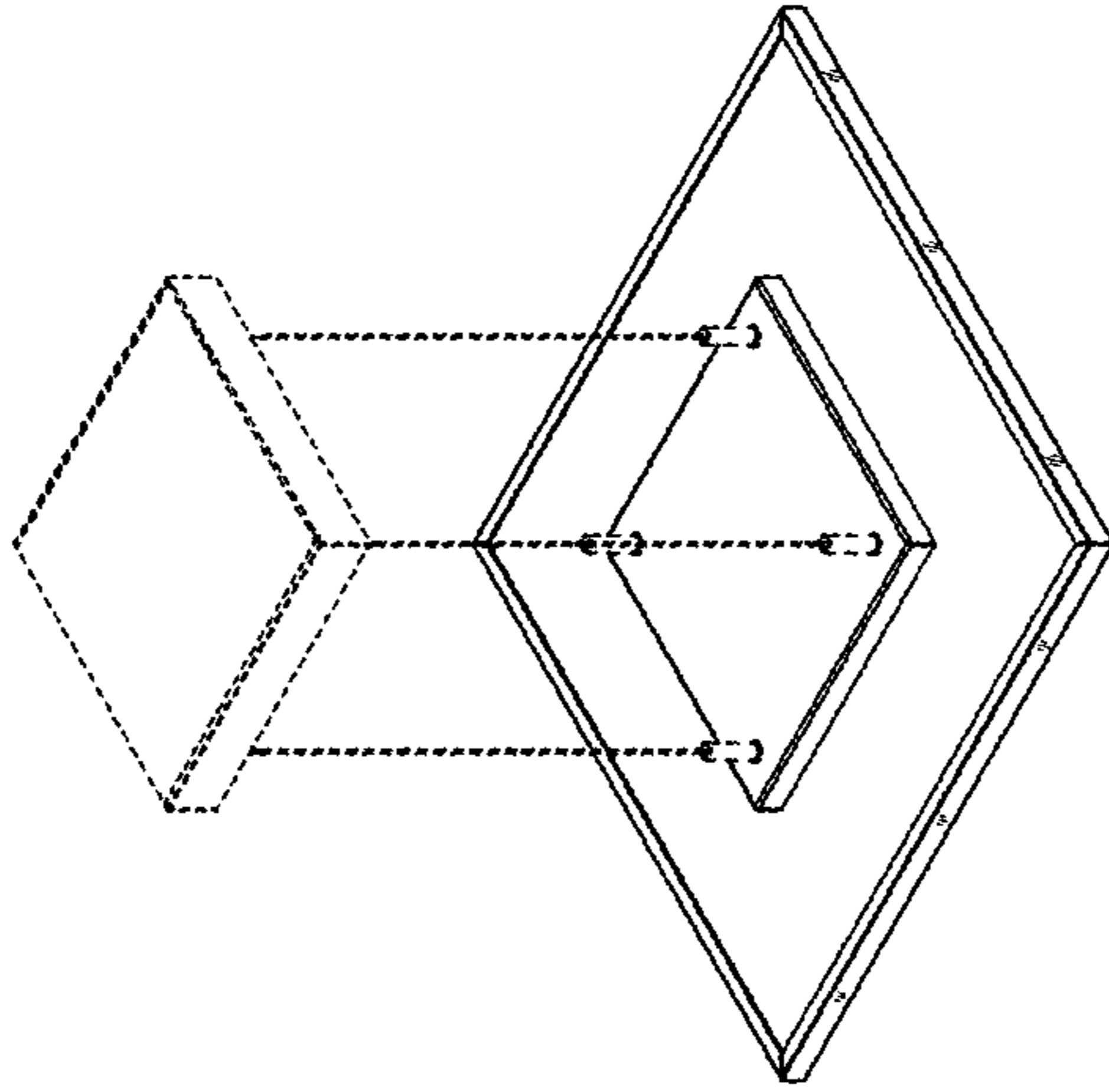

FIG. 18

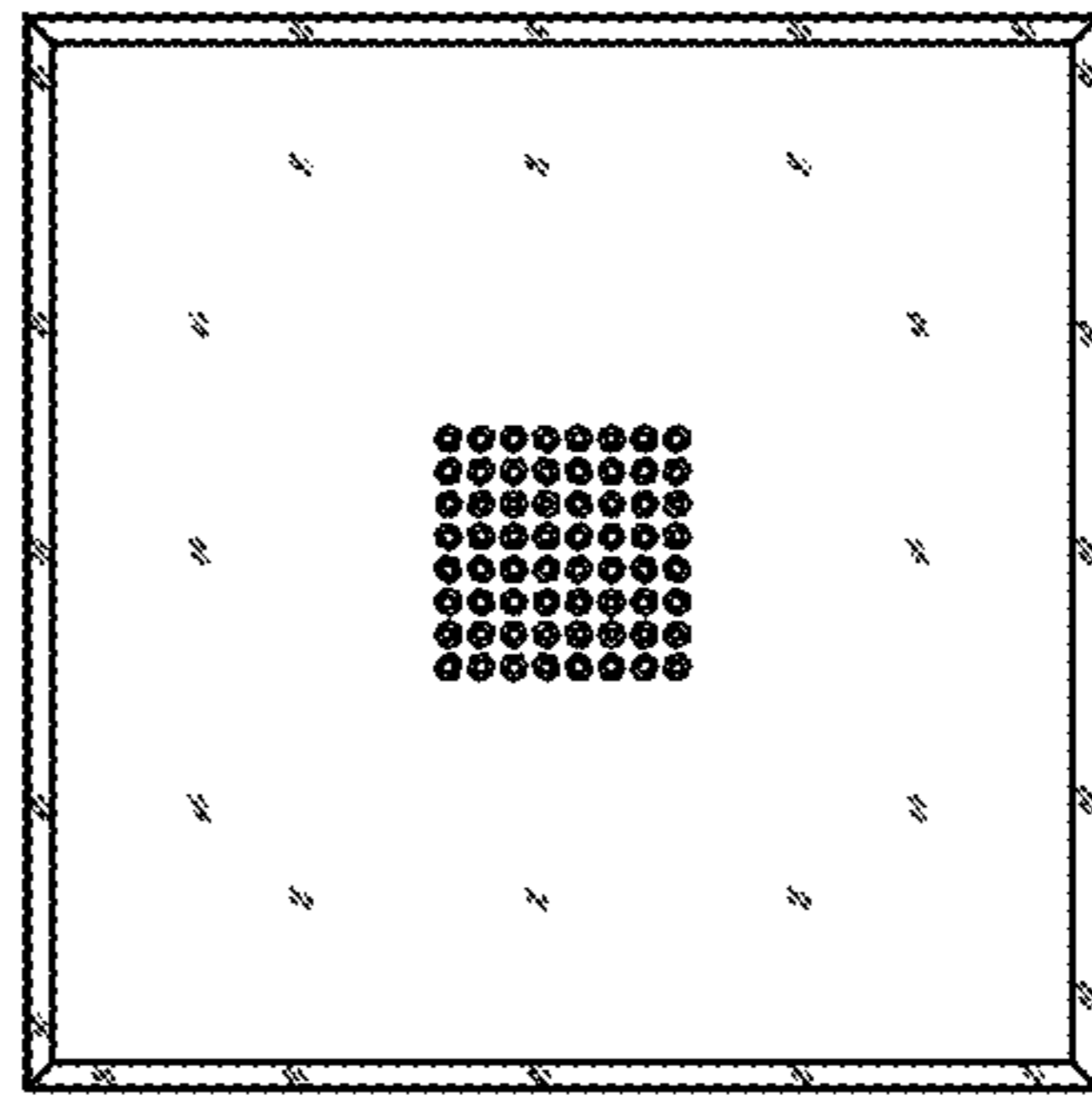

FIG. 16

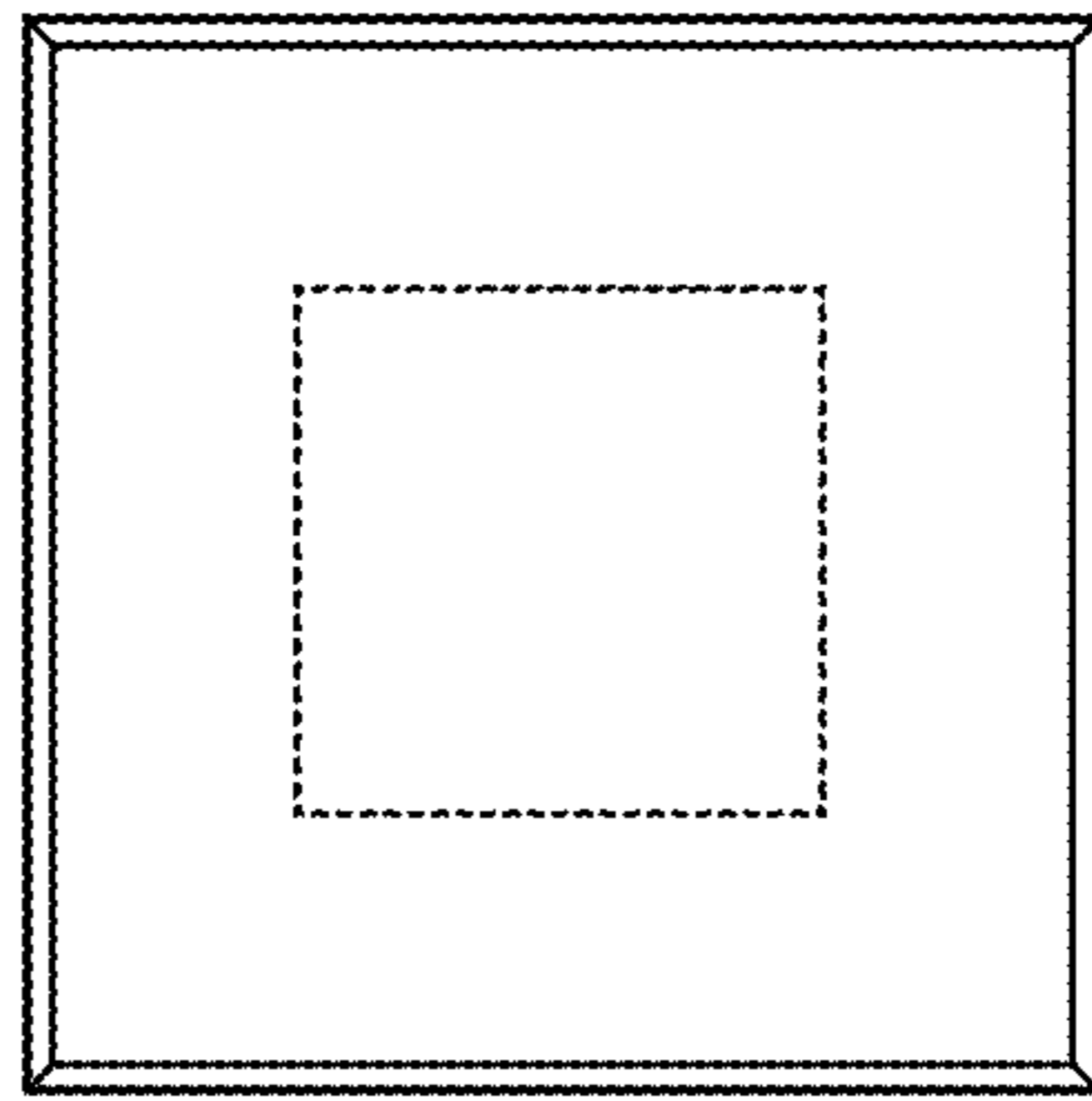

FIG. 17

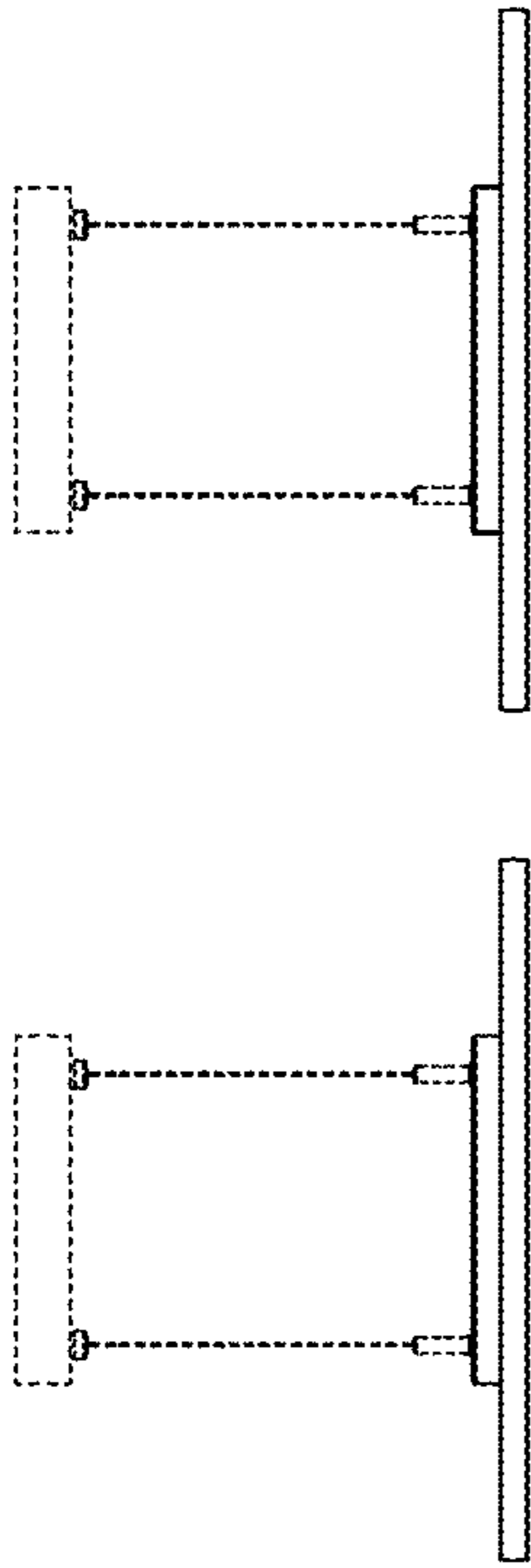

FIG. 21

FIG. 20

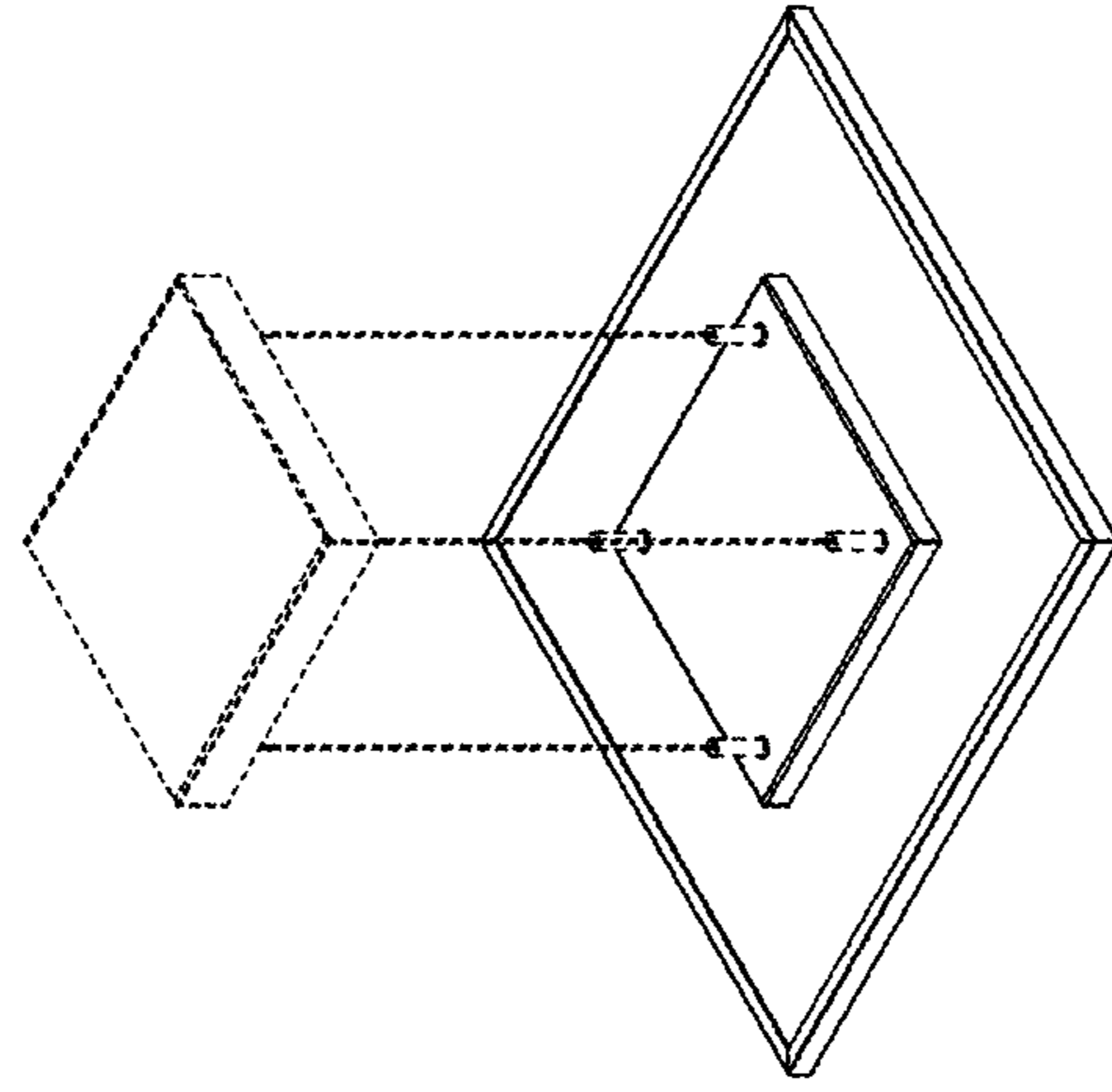

FIG. 24

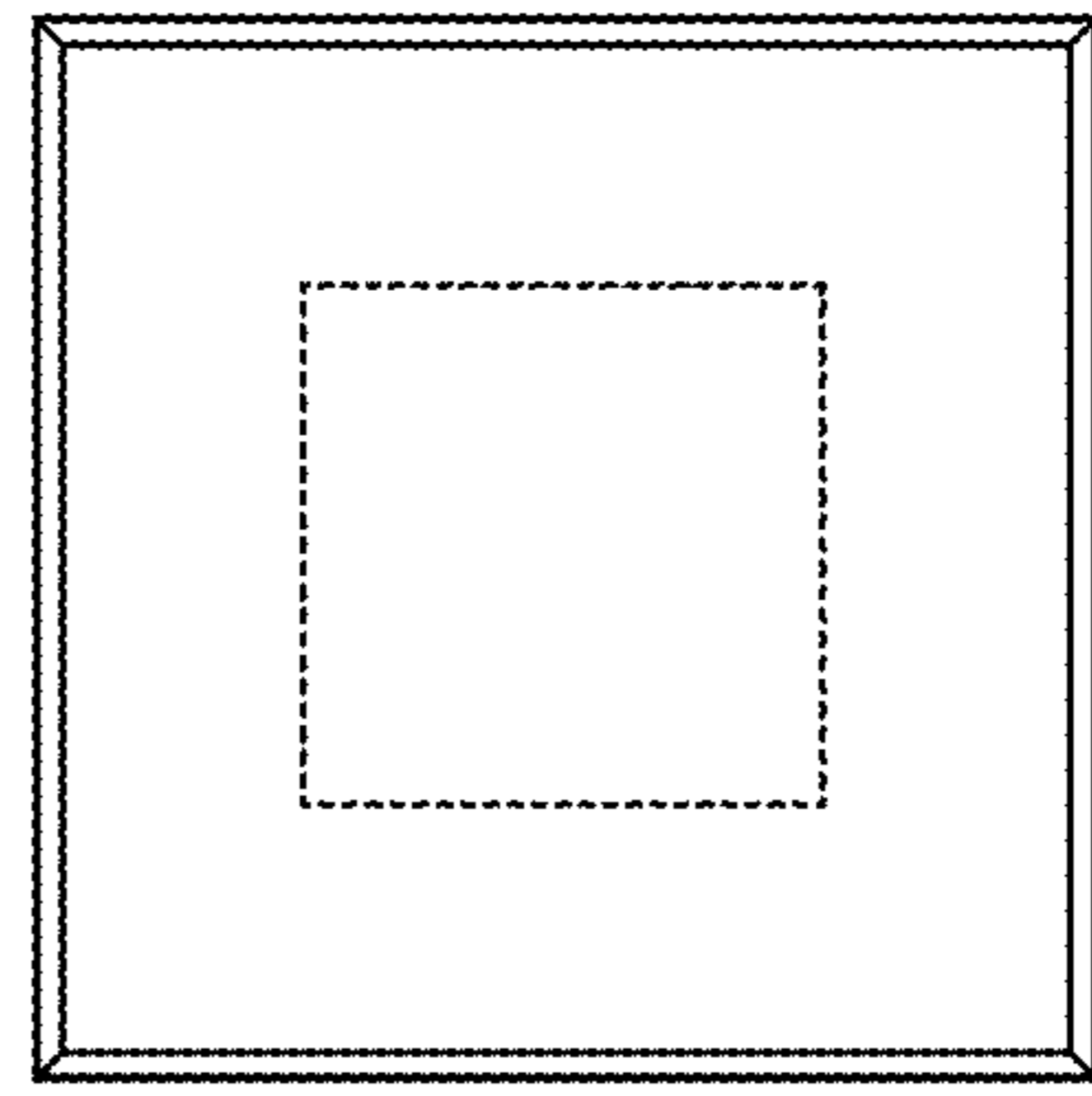

FIG. 23

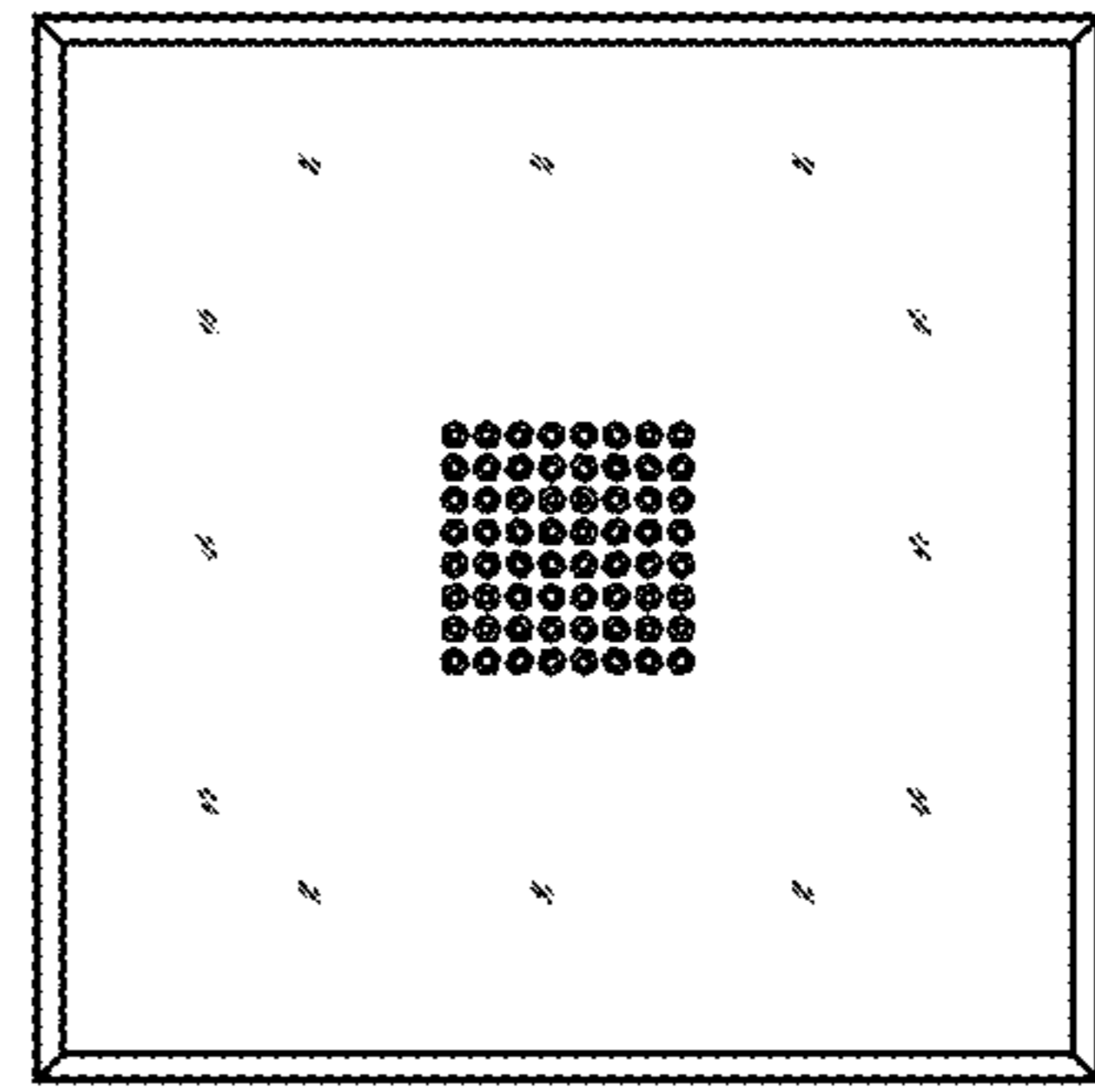

FIG. 22

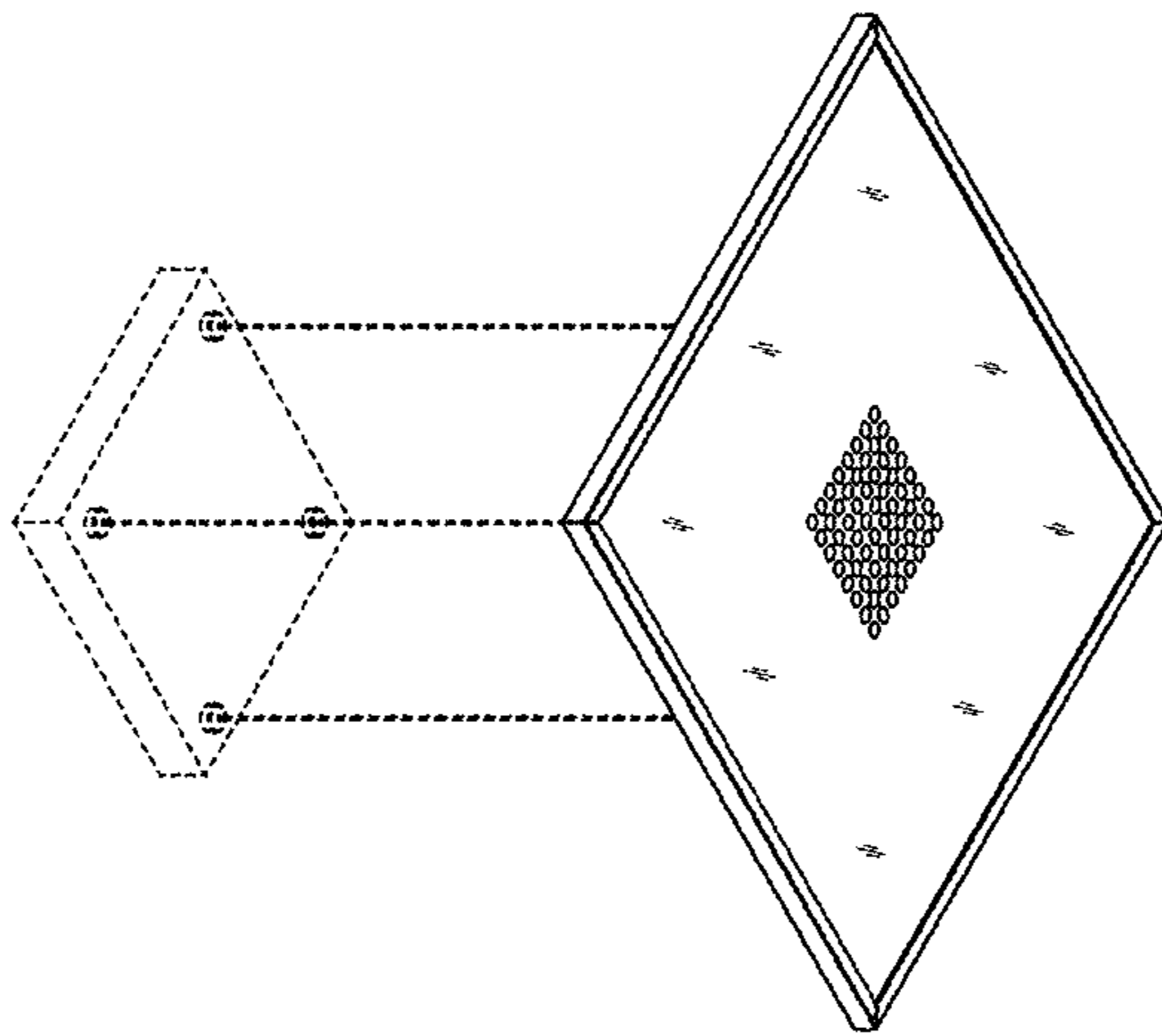

FIG. 19