



US00D892210S

(12) **United States Design Patent** (10) **Patent No.:** **US D892,210 S**
Takeuchi et al. (45) **Date of Patent:** **** Aug. 4, 2020**

(54) **PRINTER**
(71) Applicant: **CANON KABUSHIKI KAISHA,**
Tokyo (JP)
(72) Inventors: **Airi Takeuchi,** Kanagawa-ken (JP);
Akihisa Shiozaki, Kanagawa-ken (JP)
(73) Assignee: **Canon Kabushiki Kaisha,** Tokyo (JP)
(**) Term: **15 Years**

D778,983 S * 2/2017 Kim D18/53
D786,965 S * 5/2017 Huang D18/55
D803,308 S * 11/2017 Takahashi D18/36
D806,789 S * 1/2018 Hirota D18/50
D807,428 S * 1/2018 Brown D18/55
D815,197 S * 4/2018 Kim D18/50
D815,199 S * 4/2018 Kim D18/53
D819,124 S * 5/2018 Brown D18/55
D837,292 S * 1/2019 Li D18/50
D865,052 S * 10/2019 Oda D18/50
D868,151 S * 11/2019 Inada D18/55
D868,884 S * 12/2019 Inada D18/55

(21) Appl. No.: **29/725,621**
(22) Filed: **Feb. 26, 2020**

FOREIGN PATENT DOCUMENTS

JP D1589393 S 2/2018
JP D1590245 S 2/2018
JP D1590246 S 2/2018

Related U.S. Application Data

(62) Division of application No. 35/506,363, filed on Aug. 24, 2018 (U.S. filing date under 35 U.S.C. 384), and having an international filing date of Aug. 24, 2018.

* cited by examiner

Primary Examiner — Robert M. Spear
(74) *Attorney, Agent, or Firm* — Venable LLP

(30) **Foreign Application Priority Data**

Mar. 5, 2018 (JP) 2018-004511

(51) **LOC (12) Cl.** **18-02**
(52) **U.S. Cl.**
USPC **D18/55**

(57) **CLAIM**

The ornamental design for a printer, as shown and described.

(58) **Field of Classification Search**
USPC D18/50, 53, 54, 55, 56; D14/422
CPC G06K 15/12; G06K 15/14; B41J 11/00;
G03G 15/00; G03G 15/0142; H04N
1/00129; H04N 1/00204; H04N 1/00278
See application file for complete search history.

DESCRIPTION

1. Printer
FIG. 1 : Front
FIG. 2 : Back
FIG. 3 : Top
FIG. 4 : Bottom
FIG. 5 : Left
FIG. 6 : Right; and,
FIG. 7 : Perspective.

(56) **References Cited**

U.S. PATENT DOCUMENTS

D430,596 S * 9/2000 Shiozaki D18/39
D777,833 S * 1/2017 Kim D18/53

1 Claim, 7 Drawing Sheets

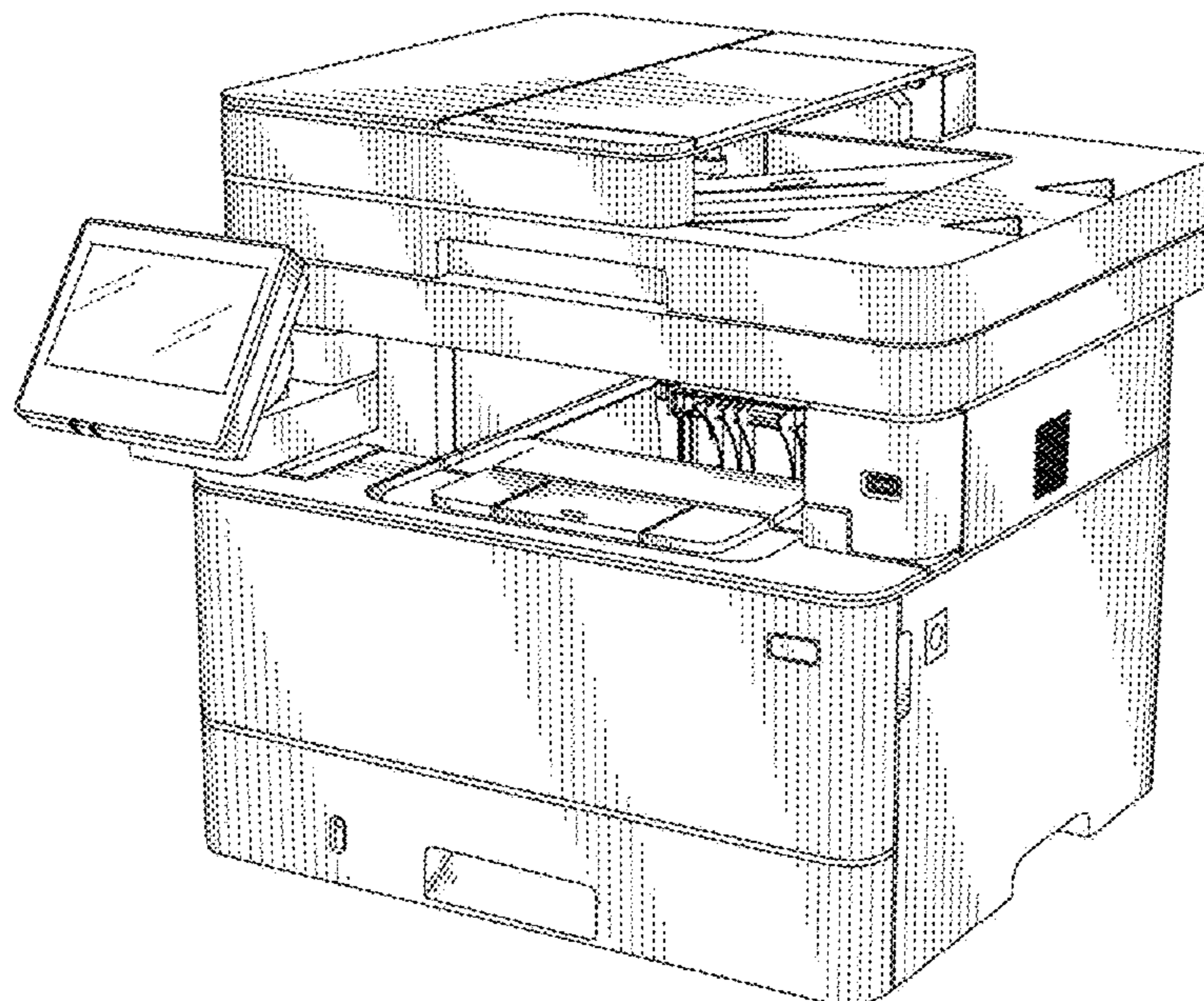

Fig. 1

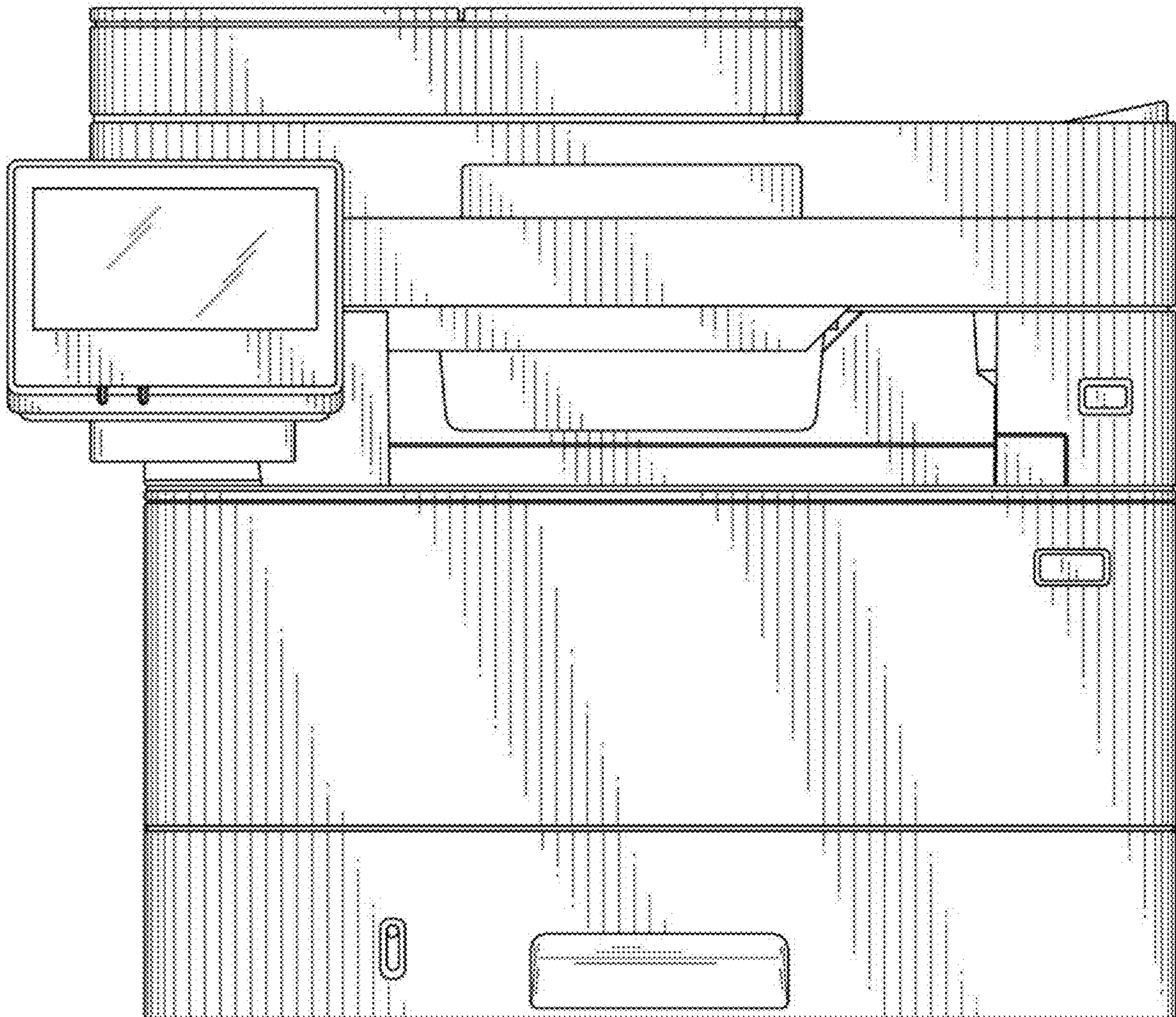

Fig. 2

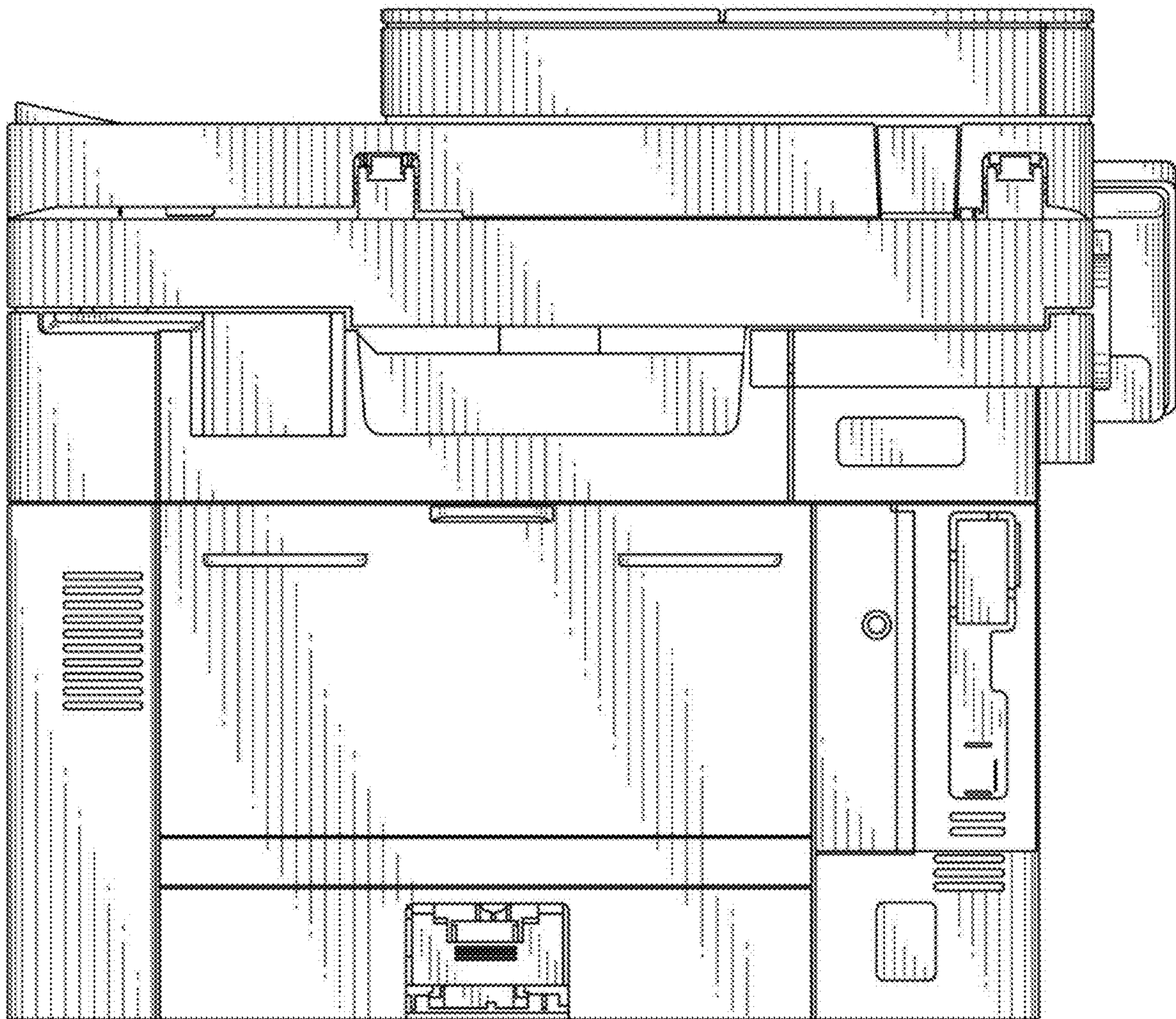

Fig. 3

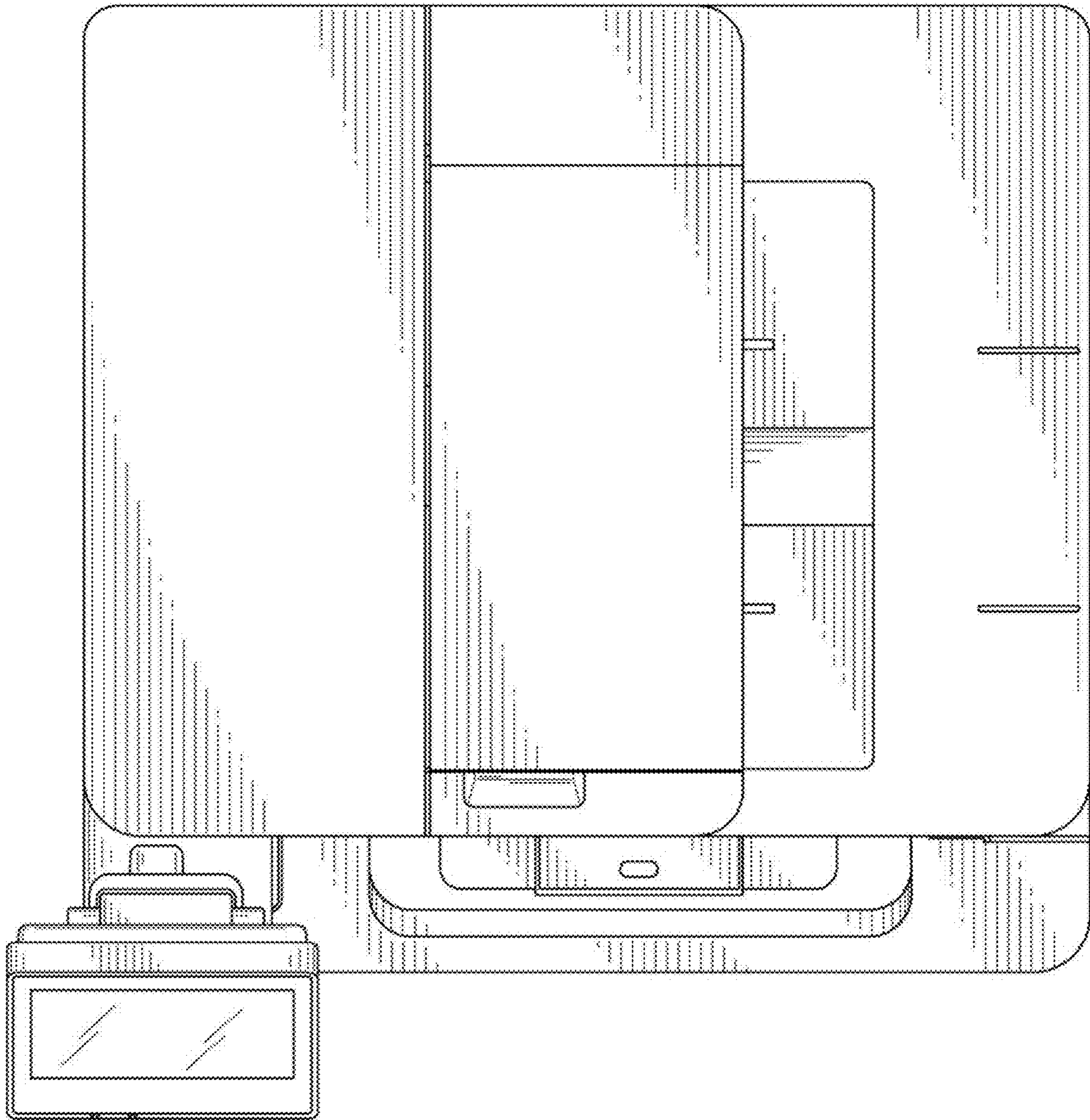

Fig. 4

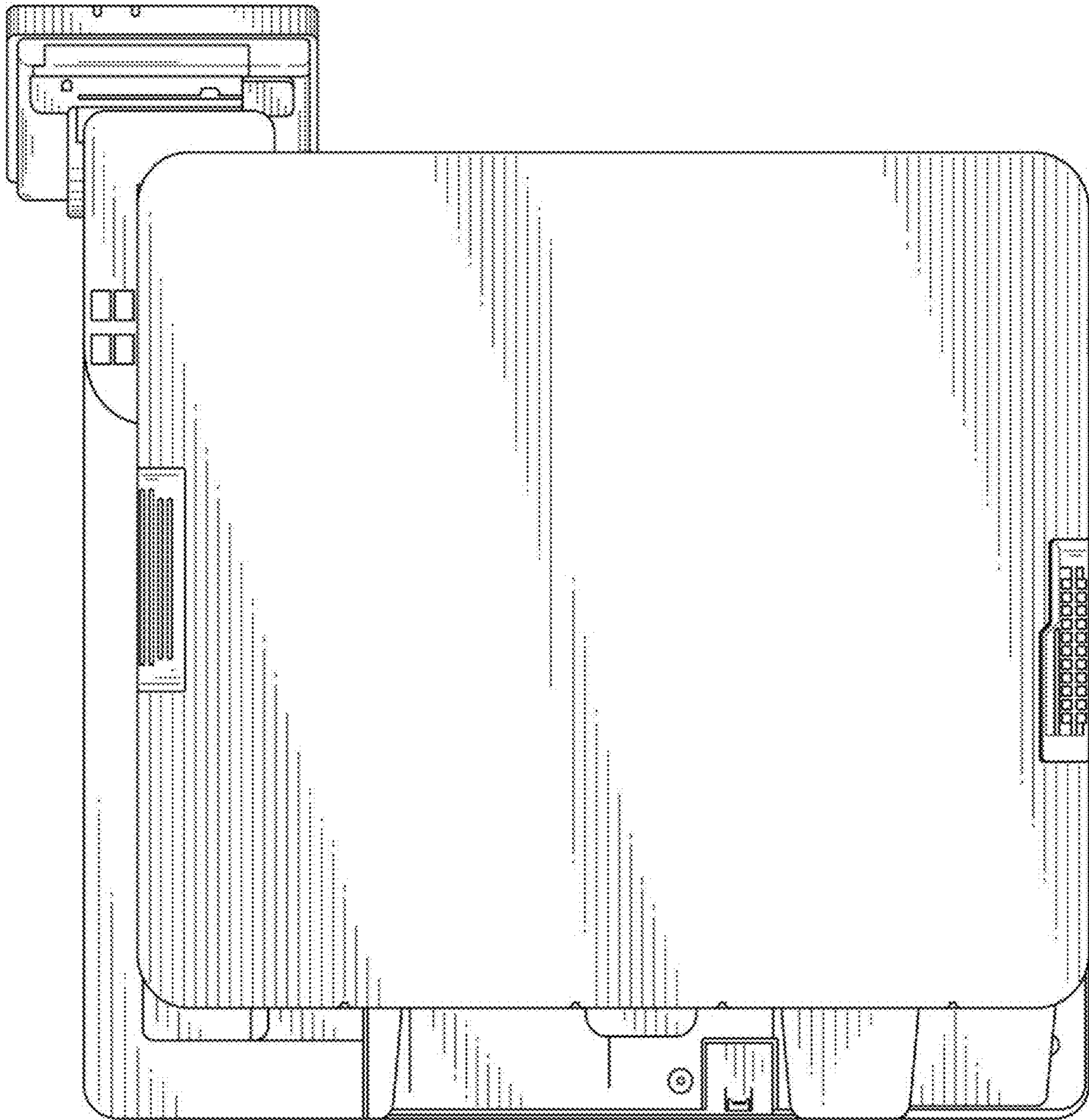

Fig. 5

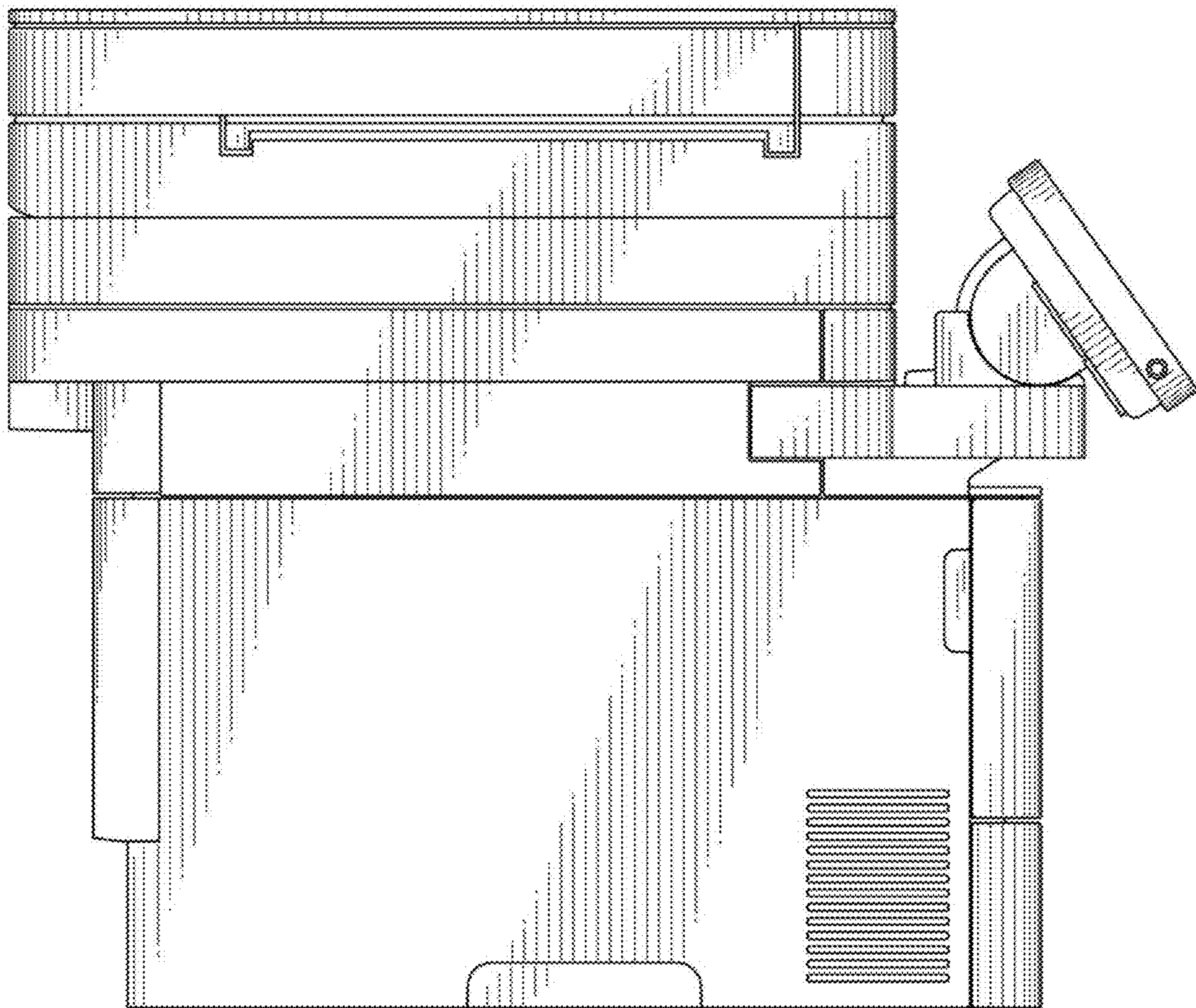

Fig. 6

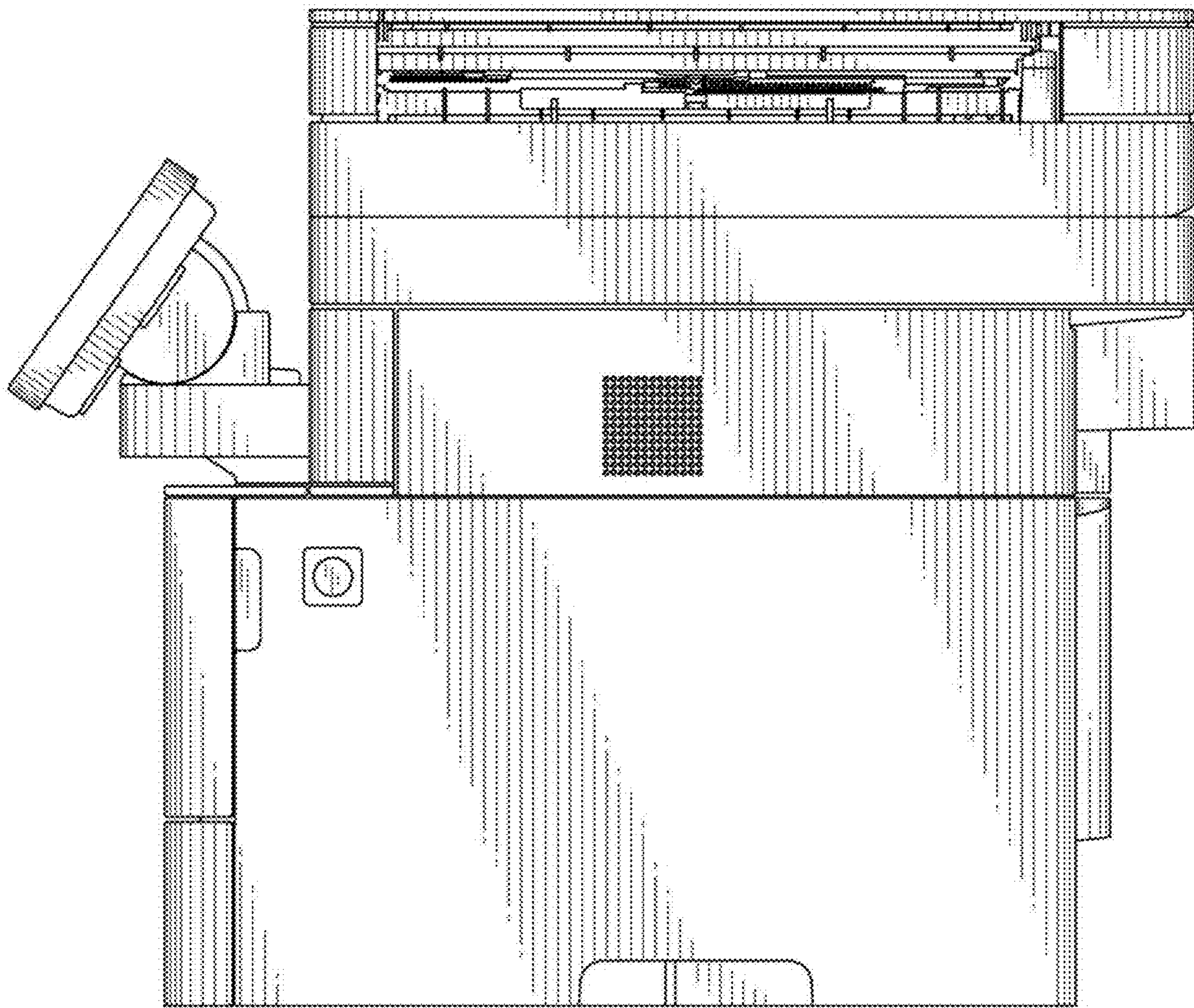

Fig. 7

