



US00D892128S

(12) **United States Design Patent** (10) **Patent No.:** **US D892,128 S**
Chen (45) **Date of Patent:** **** Aug. 4, 2020**

(54) **TABLET KEYBOARD CASE**
(71) Applicant: **HaiWen Chen**, Guangdong (CN)
(72) Inventor: **HaiWen Chen**, Guangdong (CN)
(73) Assignee: **SHENZHEN RONGHUA ELECTRIC APPLIANCE CO. LTD**, Shenzhen, Guangdong (CN)
(**) Term: **15 Years**
(21) Appl. No.: **29/694,298**
(22) Filed: **Jun. 10, 2019**
(51) **LOC (12) Cl.** **14-02**
(52) **U.S. Cl.**
USPC **D14/440; D14/316**
(58) **Field of Classification Search**
USPC D14/440, 447, 250, 316, 455; 206/45.23, 206/320, 45.2; 361/679.55; 294/25; 224/218
CPC G06F 1/1628; G06F 1/1626; G06F 1/1669; A47B 23/044; H04B 1/3888
See application file for complete search history.

D744,489 S * 12/2015 Sirichai D14/440
9,227,763 B2 * 1/2016 Gengler B65D 25/00
D748,619 S * 2/2016 Hsu D14/316
D753,648 S * 4/2016 Shyu D14/315
D764,472 S * 8/2016 Corcoran D14/440
9,451,822 B2 * 9/2016 Gu A47B 23/044
D768,638 S * 10/2016 Lee D14/440
D770,457 S * 11/2016 Massucco D14/440
D772,880 S * 11/2016 Corcoran D14/440
9,489,054 B1 * 11/2016 Sumsion G06F 3/0208
D779,494 S * 2/2017 Hallier D14/252
9,578,941 B2 * 2/2017 MacLachlan F16M 11/38
D789,342 S * 6/2017 Sirichai D14/250
D792,887 S * 7/2017 Zhang D14/440
9,717,314 B2 * 8/2017 Idehara A45C 11/00
D807,363 S * 1/2018 Hallier D14/440
D807,365 S * 1/2018 Liu D14/440
D807,892 S * 1/2018 Wang D14/440
D808,394 S * 1/2018 Lakraa D14/440
D808,395 S * 1/2018 Fenton D14/440
D811,411 S * 2/2018 Moore D14/440
D817,962 S * 5/2018 Shao D14/440
D822,675 S * 7/2018 Zhu D14/455

(Continued)

Primary Examiner — Cynthia R Underwood

(57) **CLAIM**

I claim the ornamental design for a tablet keyboard case, as shown and described.

DESCRIPTION

FIG. 1 is a front elevational view of a tablet keyboard case showing my new design;
FIG. 2 is a rear elevational view thereof;
FIG. 3 is a left side elevational view thereof;
FIG. 4 is a right side elevational view thereof;
FIG. 5 is a top plan view thereof;
FIG. 6 is a bottom plan view thereof;
FIG. 7 is a front, left, bottom perspective view thereof; and,
FIG. 8 is a rear, right, top perspective view thereof.

1 Claim, 8 Drawing Sheets

(56) **References Cited**
U.S. PATENT DOCUMENTS
D675,625 S * 2/2013 Hasbrook D14/440
D696,256 S * 12/2013 Piedra D14/440
D696,669 S * 12/2013 Akana D14/440
D700,611 S * 3/2014 Boldetti D14/440
8,766,921 B2 * 7/2014 Ballagas G09G 5/00
345/168
8,905,231 B2 * 12/2014 Couch, III A45C 11/00
206/320
D729,253 S * 5/2015 Nyholm D14/440
D733,152 S * 6/2015 Sirichai D14/440
9,095,194 B2 * 8/2015 Hassett A45C 11/00
D740,802 S * 10/2015 Hsu D14/316

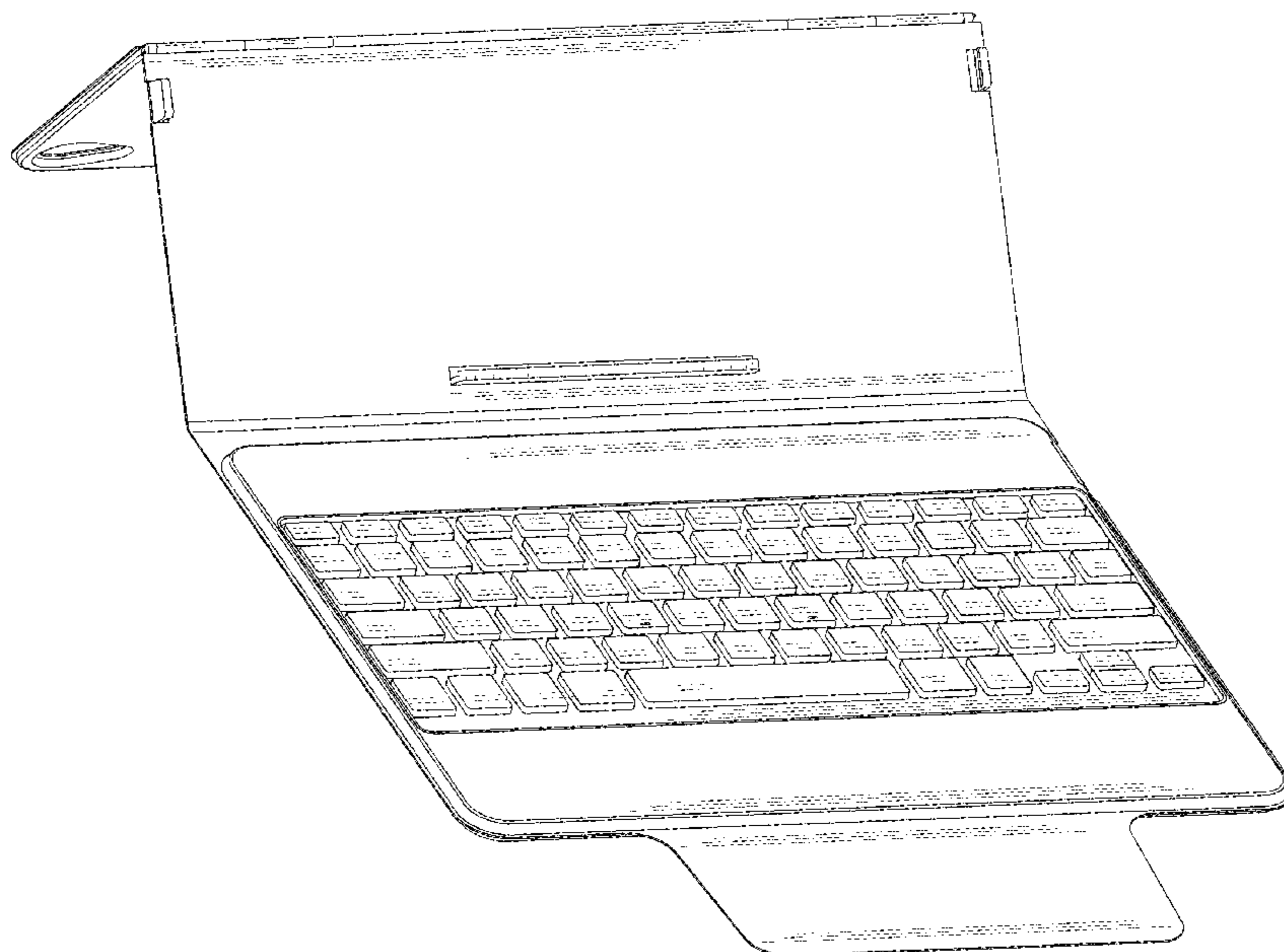

(56)

References Cited

U.S. PATENT DOCUMENTS

D832,852 S * 11/2018 Jinkinson D14/440
 D832,853 S * 11/2018 Jinkinson D14/440
 D832,854 S * 11/2018 Jinkinson D14/440
 D832,856 S * 11/2018 Jinkinson D14/440
 10,349,544 B2 * 7/2019 Katsuyama G06F 1/16
 D861,000 S * 9/2019 Zhao D14/440
 D863,935 S * 10/2019 Aoki G06F 1/1681
 D8/329
 D874,466 S * 2/2020 Lei D14/440
 2003/0193773 A1 * 10/2003 Choi G06F 1/162
 361/679.06
 2009/0194209 A1 * 8/2009 De Filippis A45C 11/00
 150/107
 2009/0201254 A1 * 8/2009 Rais G06F 1/1613
 345/168
 2010/0300909 A1 * 12/2010 Hung H04M 1/04
 206/320
 2011/0110670 A1 * 5/2011 Atkinson G06F 1/162
 398/135
 2011/0227463 A1 * 9/2011 Hou A45C 9/00
 312/223.1
 2012/0211377 A1 * 8/2012 Sajid G06F 1/1628
 206/216
 2012/0293938 A1 * 11/2012 Dai G06F 1/1622
 361/679.07

2013/0015088 A1 * 1/2013 Wu A45C 11/00
 206/320
 2013/0214661 A1 * 8/2013 McBroom G06F 1/1667
 312/325
 2013/0264459 A1 * 10/2013 McCosh G06F 1/1626
 248/688
 2014/0029189 A1 * 1/2014 Chang G06F 1/1662
 361/679.11
 2014/0083883 A1 * 3/2014 Elias G06F 1/1626
 206/320
 2014/0211393 A1 * 7/2014 Lee G06F 1/1626
 361/679.12
 2014/0218855 A1 * 8/2014 Fujino G06F 1/1681
 361/679.12
 2015/0263776 A1 * 9/2015 Shyu A45C 13/002
 455/575.8
 2015/0280768 A1 * 10/2015 Huang H04B 1/3888
 455/575.8
 2015/0293601 A1 * 10/2015 Gu G06F 3/0202
 345/168
 2015/0296060 A1 * 10/2015 Gu H04M 1/0235
 455/575.4
 2015/0296068 A1 * 10/2015 Chin G06F 1/1628
 455/575.8
 2016/0011628 A1 * 1/2016 Sato G06F 1/1656
 361/679.3
 2016/0187937 A1 * 6/2016 Ahee G06F 1/1681
 361/679.09

* cited by examiner



FIG. 1

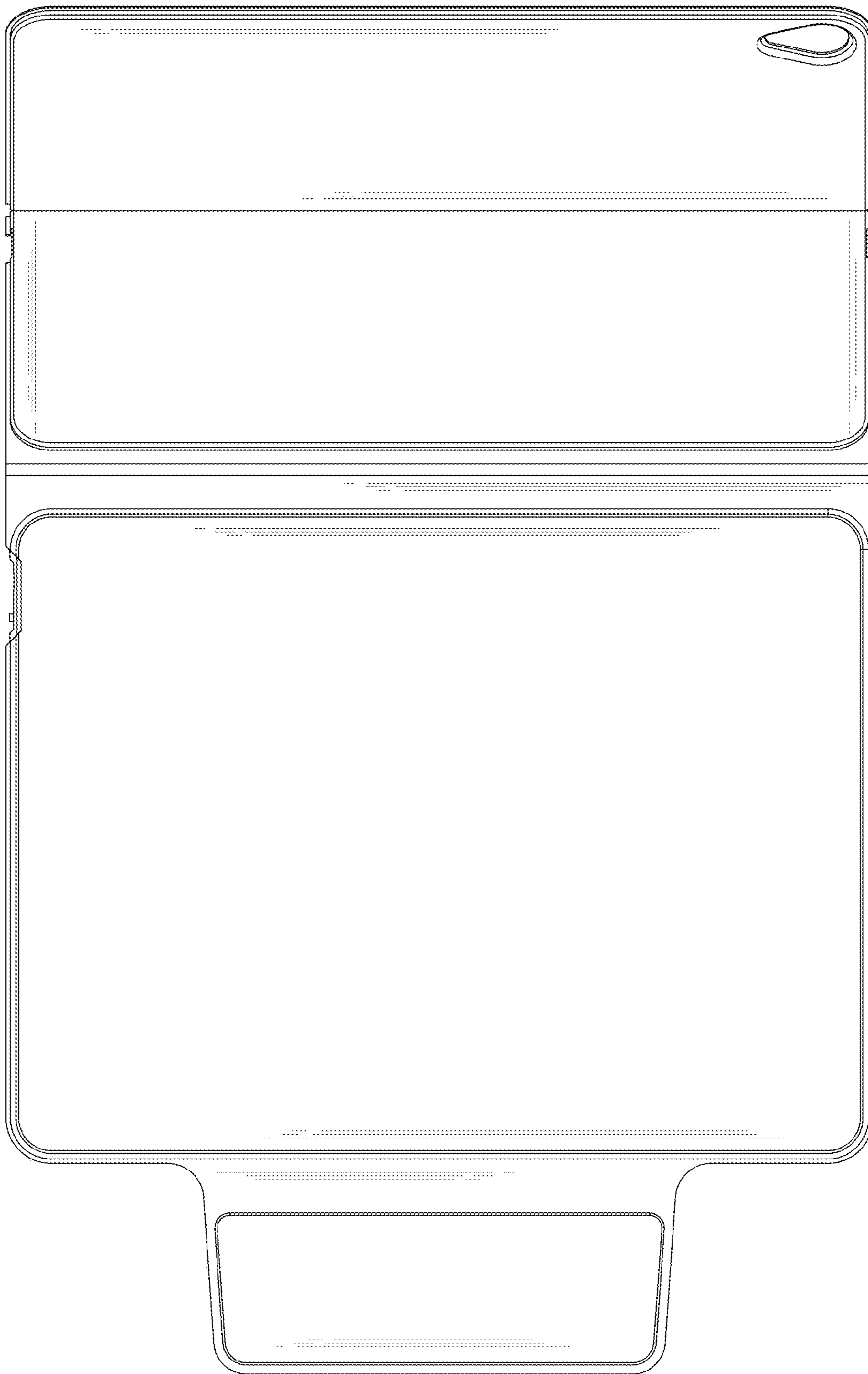

FIG. 2



FIG. 3

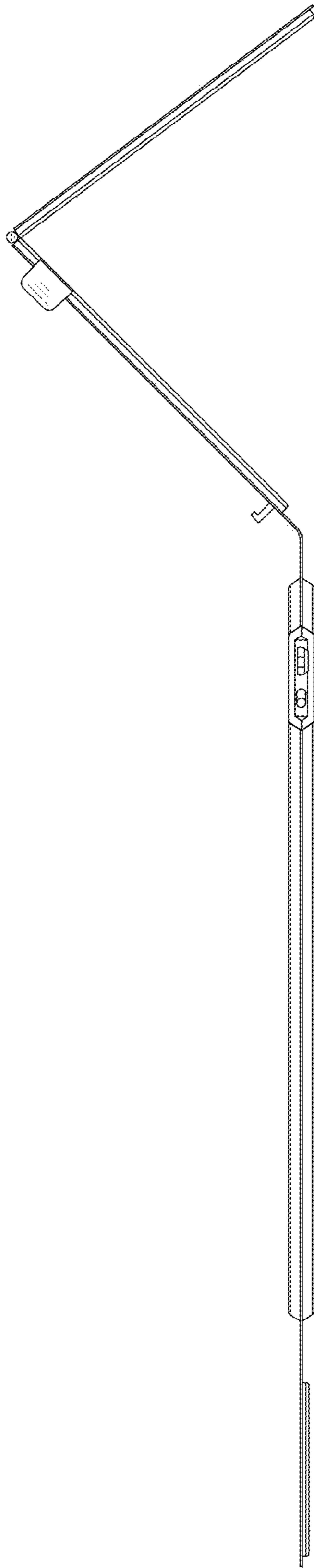

FIG. 4

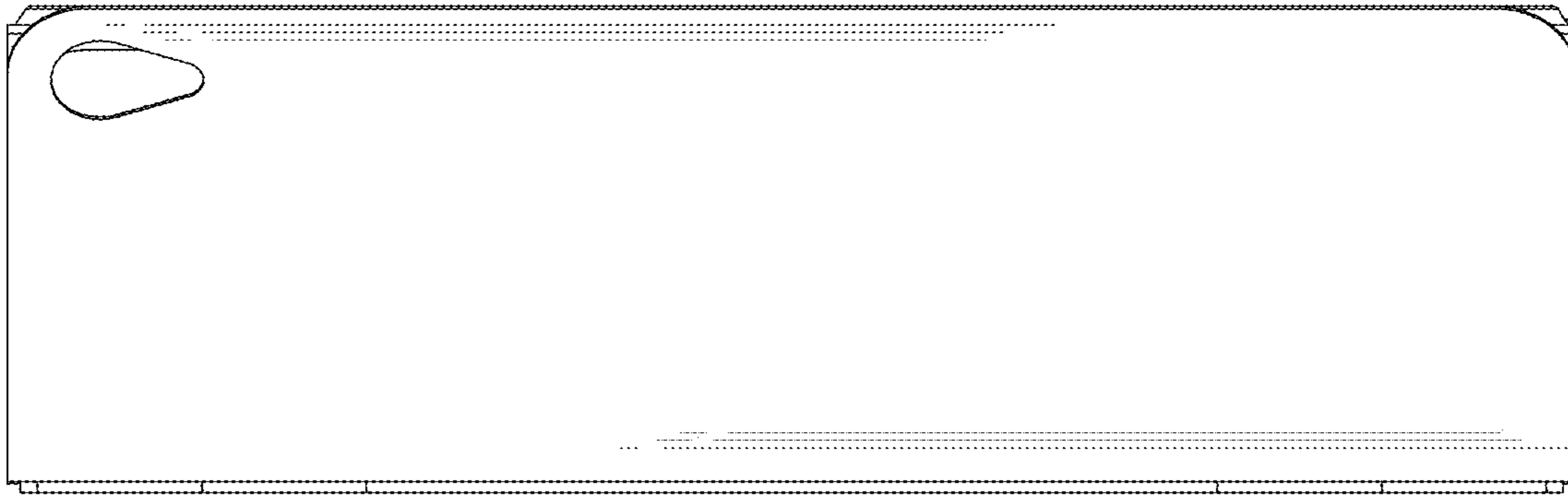

FIG. 5

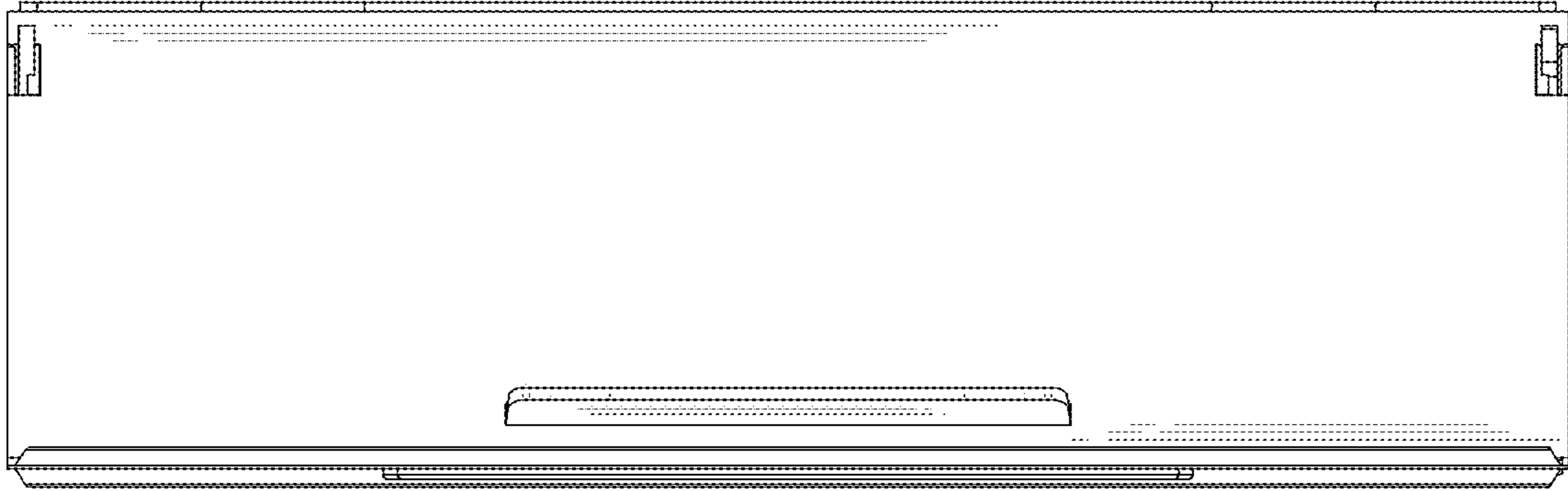

FIG. 6

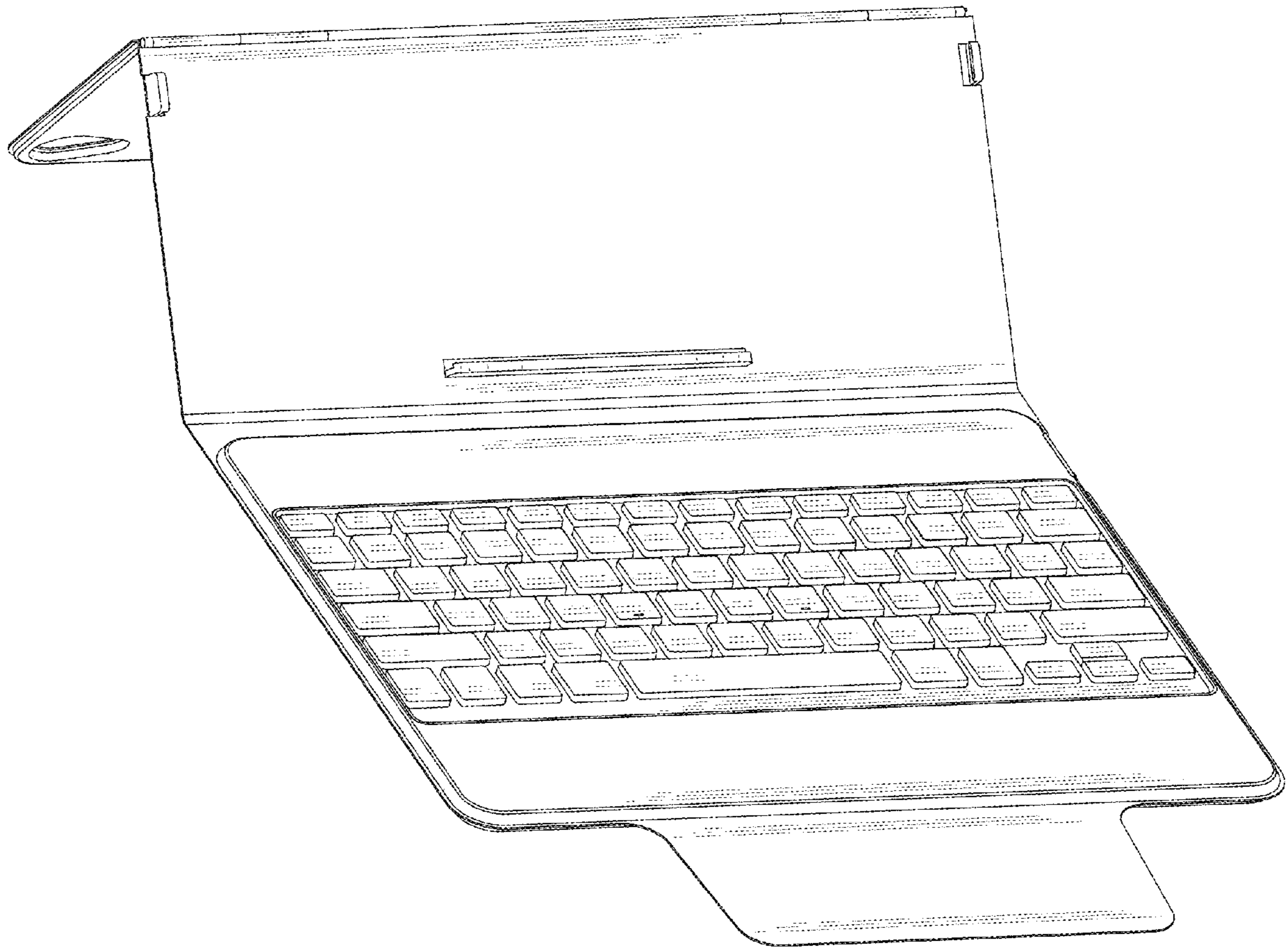

FIG. 7

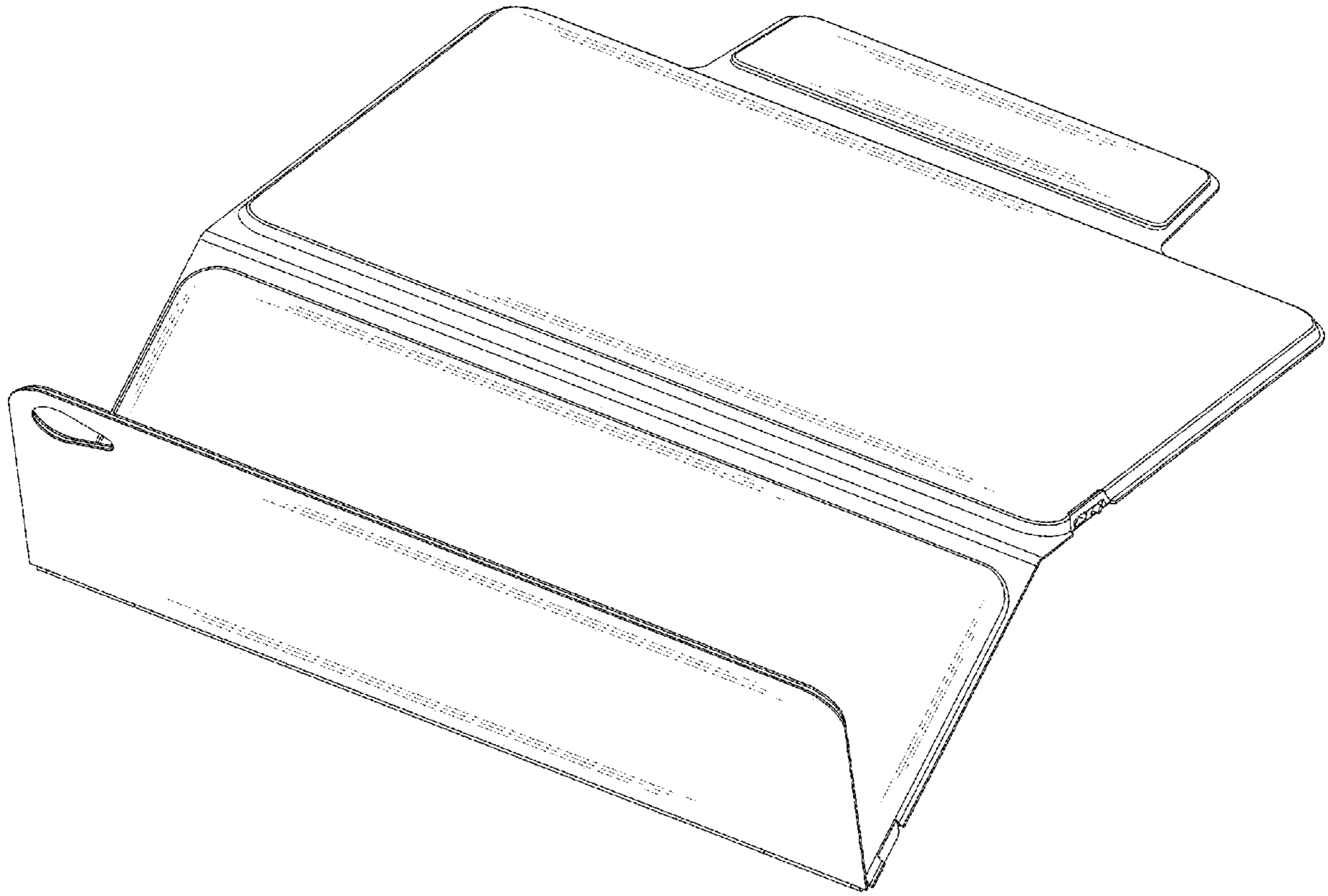

FIG. 8