

US00D892125S

(12) **United States Design Patent** (10) **Patent No.:** **US D892,125 S**
Ham (45) **Date of Patent:** **** Aug. 4, 2020**

(54) **COVER FOR ELECTRONIC DEVICE**

(71) Applicant: **Samsung Electronics Co., Ltd.**,
Suwon-si (KR)

(72) Inventor: **Sunwoong Ham**, Seoul (KR)

(73) Assignee: **Samsung Electronics Co., Ltd.**,
Suwon-si (KR)

(**) Term: **15 Years**

(21) Appl. No.: **29/677,552**

(22) Filed: **Jan. 22, 2019**

(30) **Foreign Application Priority Data**

Jul. 27, 2018 (KR) 30-2018-0034901

(51) **LOC (12) Cl.** **14-02**

(52) **U.S. Cl.**
USPC **D14/440**

(58) **Field of Classification Search**
USPC D14/440, 447, 250, 316; 206/45.23, 320,
206/45.2; 361/679.55; 294/25; 224/218
CPC G06F 1/1628; G06F 1/1626; G06F 1/1669;
A47B 23/044; H04B 1/3888
See application file for complete search history.

(56) **References Cited**

U.S. PATENT DOCUMENTS

D667,831 S *	9/2012	Stravitz	D14/447
D696,256 S *	12/2013	Piedra	D14/440
D696,669 S *	12/2013	Akana	D14/440
D700,611 S *	3/2014	Boldetti	D14/440
D719,169 S *	12/2014	McBroom	D14/440
8,905,231 B2 *	12/2014	Couch, III	A45C 11/00 206/320
8,960,421 B1 *	2/2015	Diebel	G06F 1/1679 206/320
D723,568 S *	3/2015	Kim	D14/440

D724,090 S *	3/2015	Kim	D14/440
D727,916 S *	4/2015	Melmon	D14/440
D727,919 S *	4/2015	Melmon	D14/440
D729,253 S *	5/2015	Nyholm	D14/440
D733,152 S *	6/2015	Sirichai	D14/440
D734,340 S *	7/2015	Kim	D14/440
9,095,194 B2 *	8/2015	Hassett	A45C 11/00
D744,489 S *	12/2015	Sirichai	D14/440
D744,492 S *	12/2015	Lin	G06F 1/1632 D14/440
D753,648 S *	4/2016	Shyu	D14/315
9,307,062 B2 *	4/2016	Kim	H04M 1/04
D764,472 S *	8/2016	Corcoran	D14/440
D772,880 S *	11/2016	Corcoran	D14/440
9,489,054 B1 *	11/2016	Sumsion	G06F 3/0208
D773,470 S *	12/2016	Akana	D14/440
D779,485 S *	2/2017	Akana	D14/345

(Continued)

Primary Examiner — Cynthia R Underwood

(74) *Attorney, Agent, or Firm* — NSIP Law

(57) **CLAIM**

I claim the ornamental design for a cover for electronic device, as shown and described.

DESCRIPTION

FIG. 1 is a front perspective view of a cover for electronic device showing my new design;
FIG. 2 is a front view thereof;
FIG. 3 is a rear view thereof;
FIG. 4 is a left-side view thereof;
FIG. 5 is a right-side view thereof;
FIG. 6 is a top view thereof;
FIG. 7 is a bottom view thereof;
FIG. 8 is a rear perspective view thereof; and,
FIG. 9 is a front perspective view thereof shown in an example environment of use.
The broken lines in the figures depict portions of the cover for electronic device that form no part of the claimed design.

1 Claim, 7 Drawing Sheets

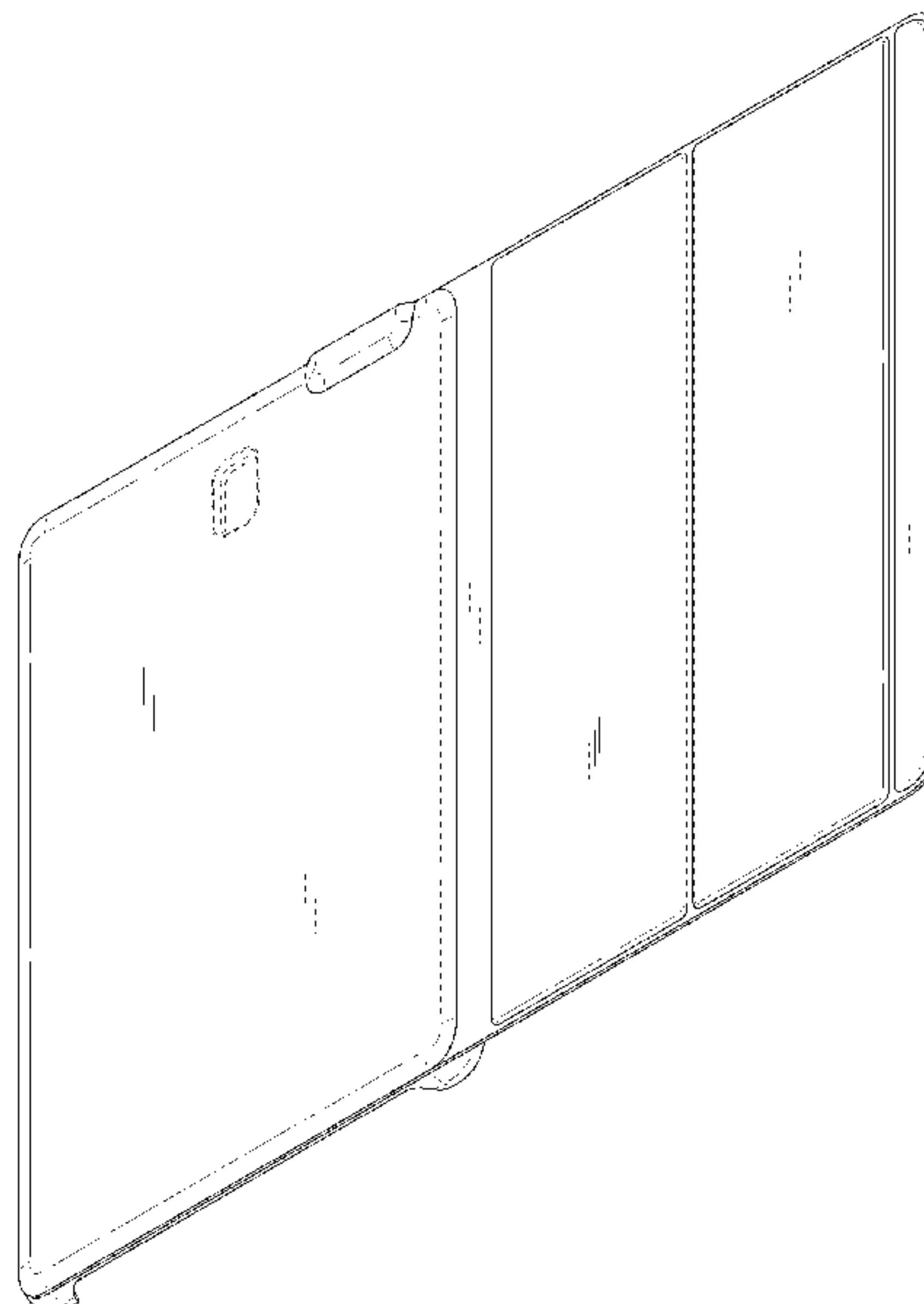

(56)

References Cited

U.S. PATENT DOCUMENTS

9,578,941 B2 * 2/2017 MacLachlan F16M 11/38
 D789,342 S * 6/2017 Sirichai D14/250
 D792,887 S * 7/2017 Zhang D14/440
 9,717,314 B2 * 8/2017 Idehara A45C 11/00
 D807,363 S * 1/2018 Hallier D14/440
 D807,365 S * 1/2018 Liu D14/440
 D807,892 S * 1/2018 Wang D14/440
 D808,394 S * 1/2018 Lakraa D14/440
 D808,395 S * 1/2018 Fenton D14/440
 D811,390 S * 2/2018 Kim D14/345
 D811,411 S * 2/2018 Moore D14/440
 D819,038 S * 5/2018 Diebel D14/440
 D820,839 S * 6/2018 Akana D14/345
 D822,675 S * 7/2018 Zhu D14/455
 D832,270 S * 10/2018 Cheng D14/440
 D864,972 S * 10/2019 Chen D14/440
 D868,072 S * 11/2019 Lei D14/440
 D871,415 S * 12/2019 Lin D14/440
 D874,466 S * 2/2020 Lei D14/440
 2007/0057140 A1 * 3/2007 Liou F16M 11/10
 248/456
 2008/0029412 A1 * 2/2008 Ho A47B 21/0314
 206/320
 2008/0167095 A1 * 7/2008 Kim H04M 1/0216
 455/575.3
 2009/0159763 A1 * 6/2009 Kim F16M 13/00
 248/174
 2009/0178938 A1 * 7/2009 Palmer A45C 5/03
 206/45.23
 2009/0194209 A1 * 8/2009 De Filippis A45C 11/00
 150/107
 2009/0201254 A1 * 8/2009 Rais G06F 1/1613
 345/168

2010/0294909 A1 * 11/2010 Hauser A47B 23/043
 248/456
 2010/0300909 A1 * 12/2010 Hung H04M 1/04
 206/320
 2011/0227463 A1 * 9/2011 Hou A45C 9/00
 312/223.1
 2011/0266194 A1 * 11/2011 Bau A45C 11/00
 206/736
 2011/0290687 A1 * 12/2011 Han A45C 3/02
 206/320
 2011/0297566 A1 * 12/2011 Gallagher F16M 11/105
 206/320
 2012/0140396 A1 * 6/2012 Zelif G06F 1/1628
 361/679.09
 2013/0140194 A1 * 6/2013 Han G06F 1/1656
 206/45.23
 2013/0233762 A1 * 9/2013 Balaji B65D 25/00
 206/736
 2013/0264459 A1 * 10/2013 McCosh G06F 1/1626
 248/688
 2014/0291175 A1 * 10/2014 Chung G06F 1/1656
 206/45.23
 2015/0263776 A1 * 9/2015 Shyu A45C 13/002
 455/575.8
 2015/0280768 A1 * 10/2015 Huang H04B 1/3888
 455/575.8
 2015/0296060 A1 * 10/2015 Gu H04M 1/0235
 455/575.4
 2015/0296068 A1 * 10/2015 Chin G06F 1/1628
 455/575.8
 2016/0011628 A1 * 1/2016 Sato G06F 1/1656
 361/679.3
 2016/0187937 A1 * 6/2016 Ahee G06F 1/1681
 361/679.09

* cited by examiner

FIG. 1

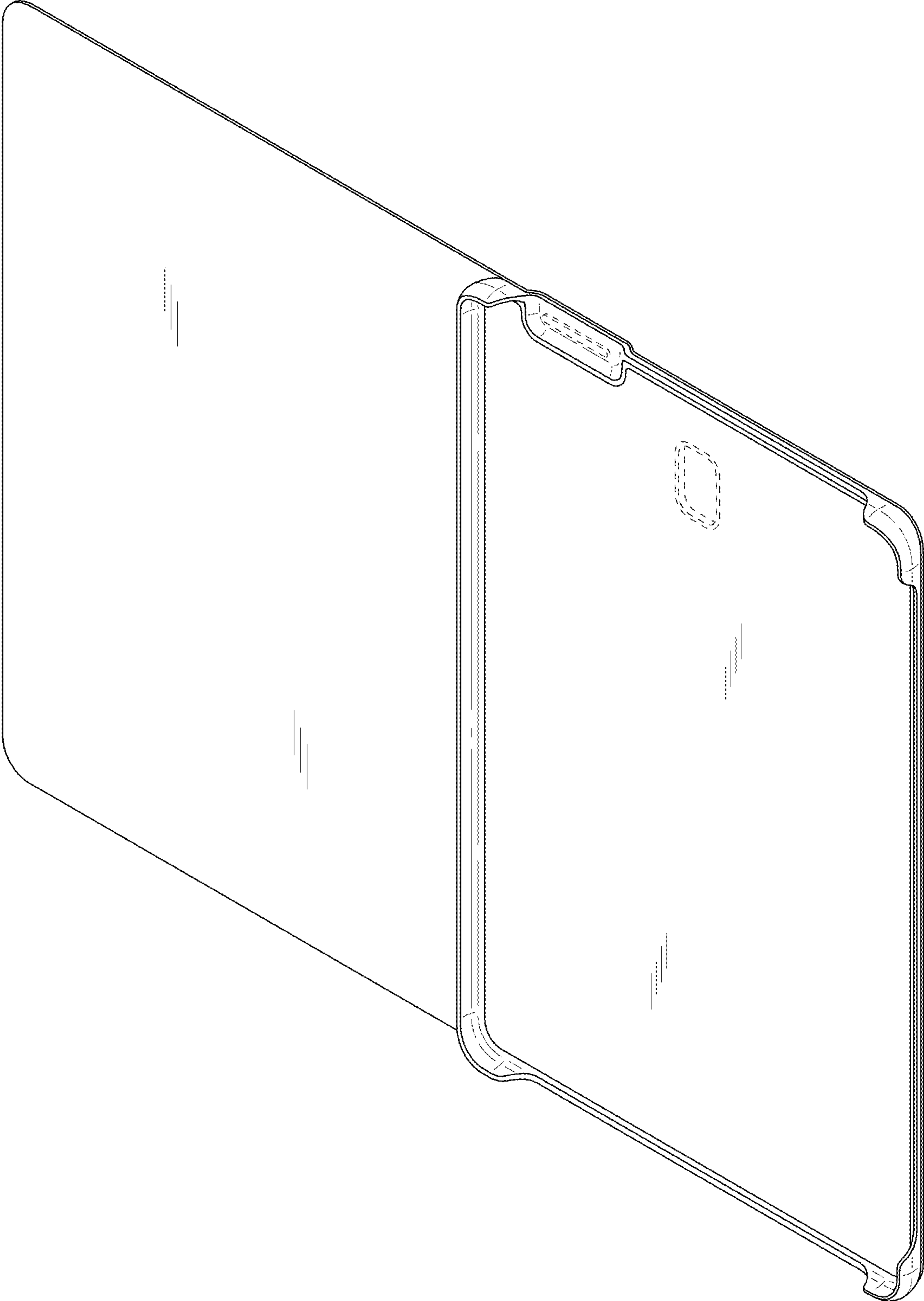

FIG.2

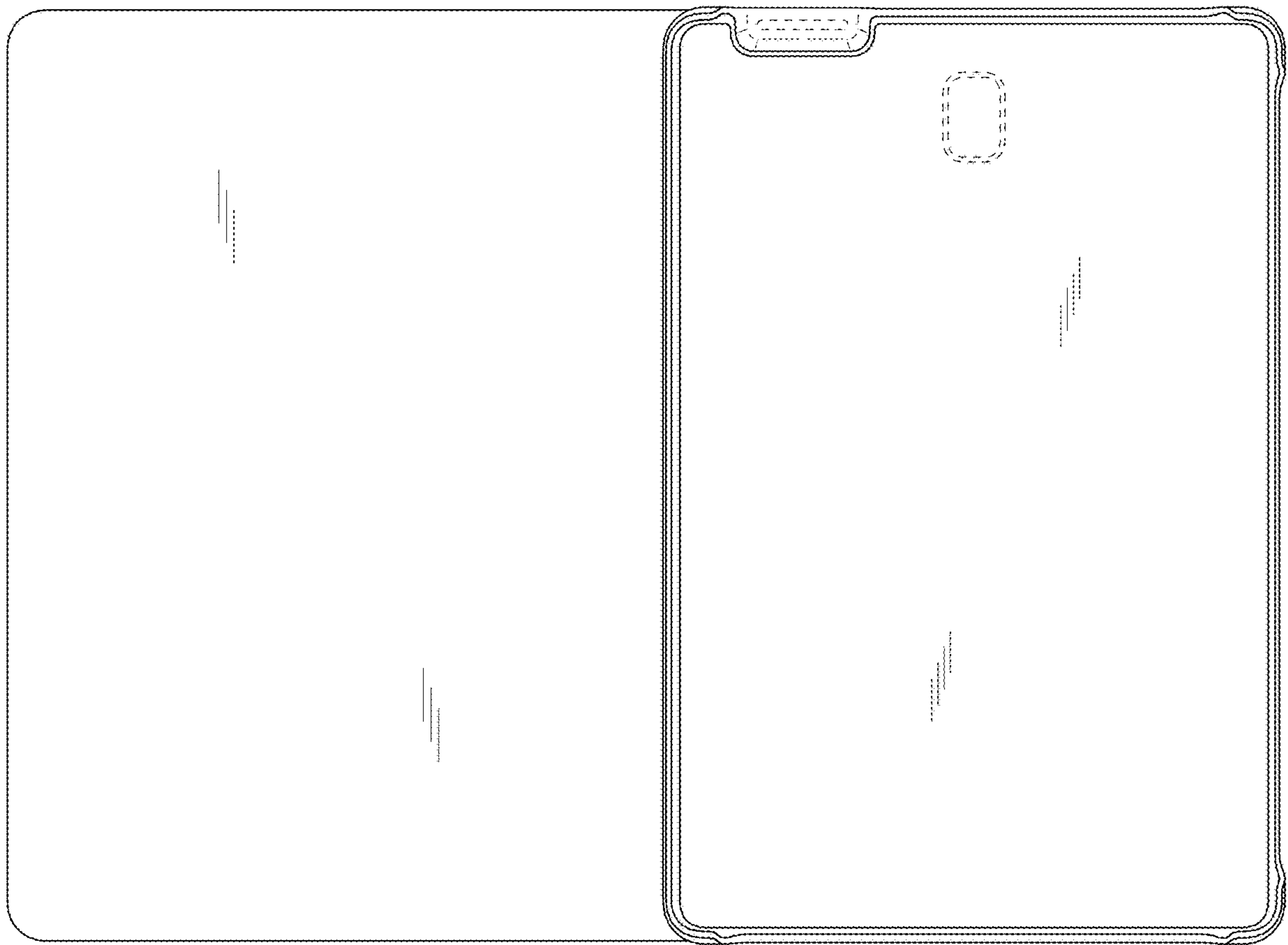

FIG.3

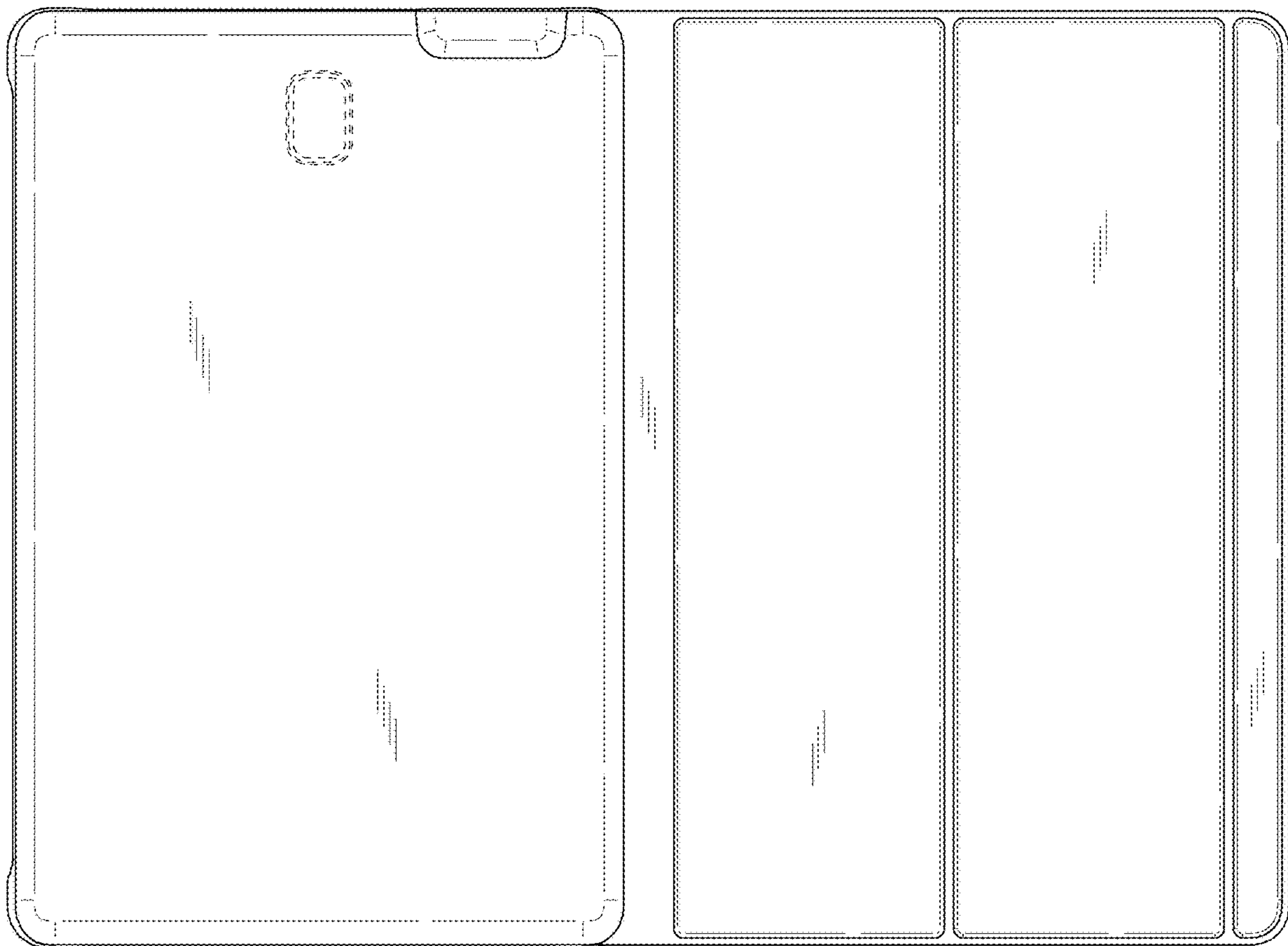

FIG.4



FIG.5

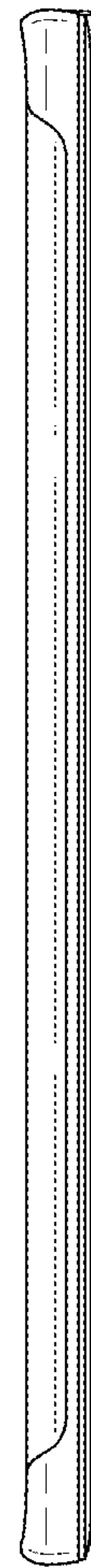

FIG.6

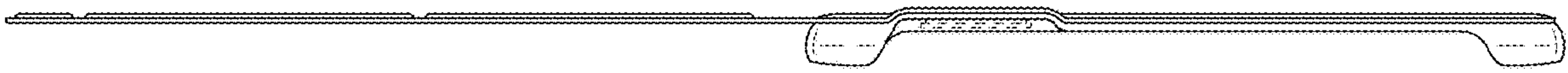

FIG.7



FIG.8

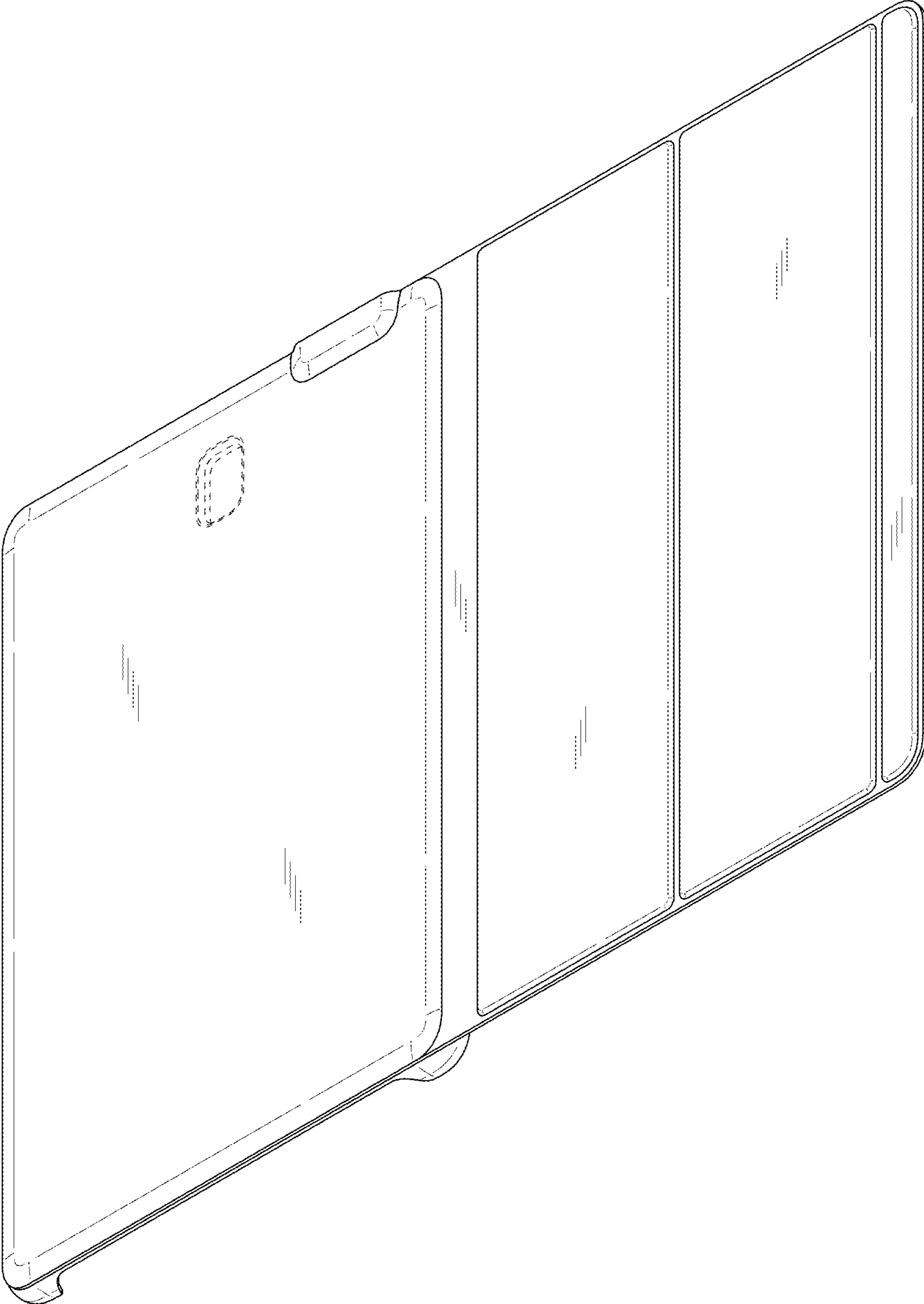

FIG.9

