



US00D892101S

(12) **United States Design Patent** (10) **Patent No.:** **US D892,101 S**  
**Kim** (45) **Date of Patent:** **\*\* \*Aug. 4, 2020**

- (54) **PHONE CASE**
- (71) Applicant: **Spigen, Inc.**, Irvine, CA (US)
- (72) Inventor: **Woojin Kim**, Fullerton, CA (US)
- (73) Assignee: **SPIGEN, INC.**, Irvine, CA (US)
- (\* ) Notice: This patent is subject to a terminal disclaimer.
- (\*\*) Term: **15 Years**
- (21) Appl. No.: **29/625,856**
- (22) Filed: **Nov. 13, 2017**
- (51) **LOC (12) Cl.** ..... **14-03**
- (52) **U.S. Cl.**  
USPC ..... **D14/250**
- (58) **Field of Classification Search**  
USPC ..... D3/201, 218, 226, 227, 247, 249, 250,  
D3/269, 303; D13/103, 107, 108, 119;  
D14/137, 138 R, 138 AA, 138 C, 138 G,  
D14/172, 192, 203.3–203.7, 217, 238.1,  
D14/247, 248, 250–253, 434, 440, 447,  
D14/496  
CPC ..... H04B 1/3888; H04M 1/0283; H04M  
1/0202; A45C 1/06; A45C 2011/002;  
A45C 11/00; A45F 2005/028; A45F  
2200/0525  
See application file for complete search history.

- D704,685 S \* 5/2014 Yeh ..... D14/248
  - D709,869 S \* 7/2014 Witter ..... D14/250
  - D729,219 S \* 5/2015 Yung ..... D14/250
- (Continued)

**OTHER PUBLICATIONS**

“Spigen Rugged Armor iPhone 6S Case with Resilient Shock Absorption and Carbon Fiber Design for iPhone 6S/iPhone 6—Black”, <https://www.amazon.com/dp/B010MVJM5K>, earliest review date of 20150903, downloaded on Jul. 17, 2018.  
(Continued)

*Primary Examiner* — Susan E Krakower  
*Assistant Examiner* — L. A. Grabenstetter  
(74) *Attorney, Agent, or Firm* — Heedong Chae; Lucem, PC

(57) **CLAIM**

The ornamental design for a phone case, as shown and described.

**DESCRIPTION**

FIG. 1 is a top perspective view showing the top, front, and right sides as well as the inner left interior surface of a phone case;  
FIG. 2 is a bottom perspective view showing the bottom, front, and left sides as well as the inner right interior surface of the phone case;  
FIG. 3 is a further bottom perspective view showing the bottom, front, and right sides as well as the inner left interior surface of the phone case;  
FIG. 4 is a further bottom perspective view showing the bottom, left, and rear sides of the phone case;  
FIG. 5 is a front elevation view of the phone case;  
FIG. 6 is a rear elevation view of the phone case;  
FIG. 7 is a left side elevation view of the phone case;  
FIG. 8 is a right side elevation view of the phone case;  
FIG. 9 is a top plan view of the Phone Case; and,  
FIG. 10 is a bottom plan view of the phone case.  
The broken lines in the drawings represent portions of the phone case that form no part of the claimed design.

**1 Claim, 10 Drawing Sheets**

(56) **References Cited**

**U.S. PATENT DOCUMENTS**

- D96,015 S \* 6/1935 Bruine ..... D5/56
- D609,230 S 2/2010 Ferrari et al.
- D645,015 S 9/2011 Lee et al.
- D645,834 S 9/2011 Lee et al.
- D673,545 S 1/2013 Magness et al.
- D698,343 S 1/2014 Chang et al.
- D703,656 S \* 4/2014 Witter ..... D14/250
- D704,684 S 5/2014 Yeh et al.

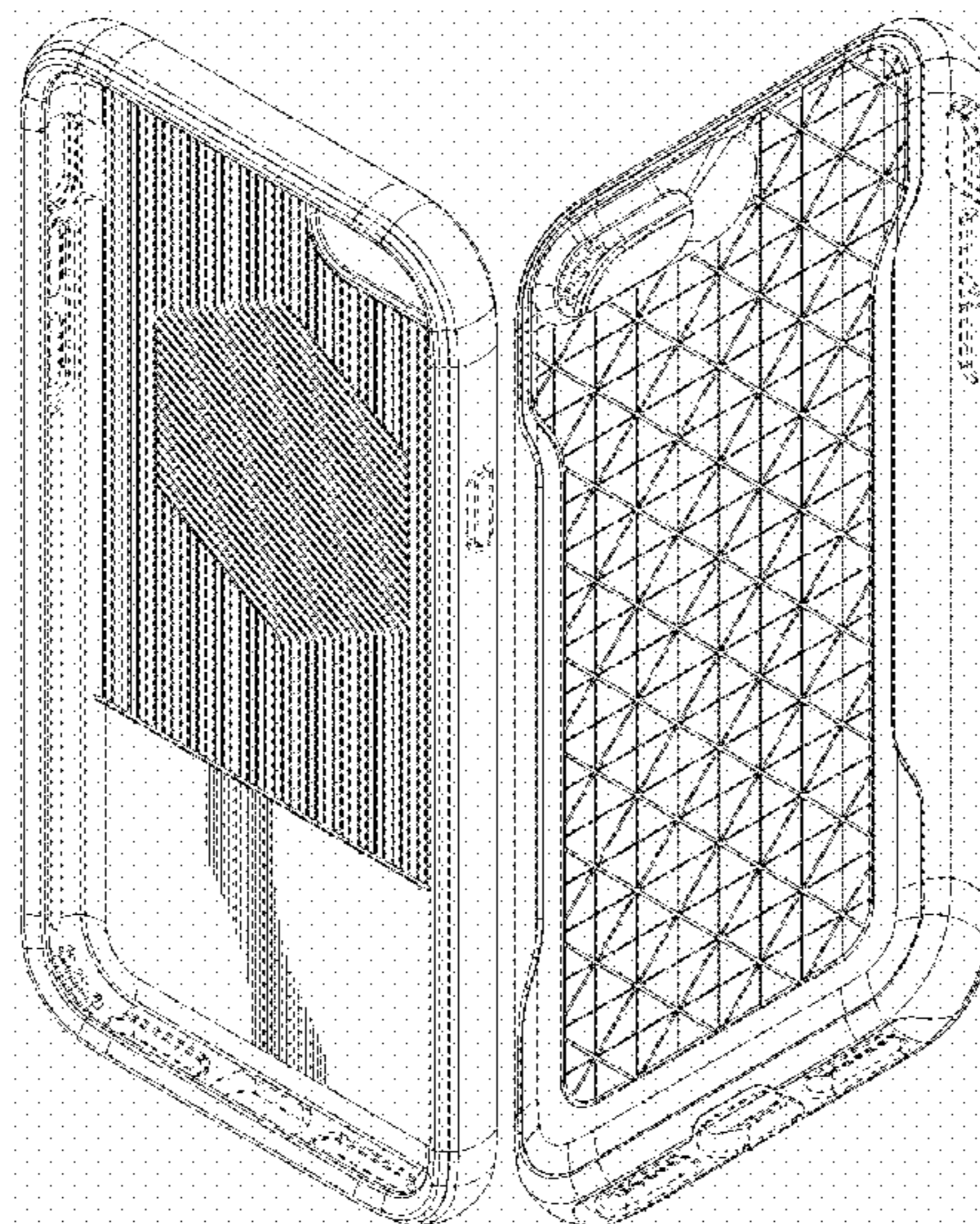

(56)

References Cited

U.S. PATENT DOCUMENTS

D734,747	S	7/2015	Seo et al.	
D737,259	S	8/2015	Choi	
D742,869	S *	11/2015	Odhwani .....	D14/250
D755,167	S *	5/2016	Chen .....	D14/248
D766,227	S	9/2016	Wu	
D767,554	S	9/2016	Bertrand et al.	
D771,027	S *	11/2016	Prstojevich .....	D14/250
D772,856	S	11/2016	Taylor et al.	
D772,857	S	11/2016	Poon	
D772,858	S	11/2016	Hu	
D776,098	S	1/2017	Poon	
D782,460	S *	3/2017	Bertrand .....	D14/250
D786,853	S	5/2017	Friedland et al.	
D790,526	S	6/2017	Babichenko	
D791,773	S *	7/2017	Moore .....	D14/440
D792,875	S *	7/2017	Kim .....	D14/250
D792,877	S *	7/2017	Kim .....	D14/250
D792,878	S *	7/2017	Kim .....	D14/250
D798,288	S	9/2017	Babichenko	
D798,854	S	10/2017	Babichenko	
D799,462	S	10/2017	Wright	
D808,373	S	1/2018	Brown et al.	
D832,269	S	10/2018	Cheng	
D838,710	S	1/2019	Wang	
D841,011	S	2/2019	Mecchella et al.	
D843,363	S	3/2019	Yan	
2015/0168789	A1 *	6/2015	Kwon .....	G02F 1/134336 349/33

OTHER PUBLICATIONS

“Spigen Rugged Armor iPhone 6S Plus Case with Resilient Shock Absorption and Carbon Fiber Design for iPhone 6S Plus 2015—Black”, <https://www.amazon.com/dp/B010MVR76Q>, earliest review date of Sep. 7, 2015, downloaded on Jul. 17, 2018.

“Spigen Tough Armor TECH iPhone 6S Case with Extreme Shock and Drop Protection for Apple iPhone 6 / 6S—Gunmetal”, <https://www.amazon.com/dp/B013TKNSIS>, earliest review date of Oct. 3, 2015, downloaded on Jan. 15, 2019.

“Caseology Parallax for Samsung Galaxy S7 Case (2016)—Pink”, <https://www.amazon.com/dp/B01BUDURF1/>, Earliest review date of Mar. 9, 2016, Downloaded on Jan. 13, 2020.

Galaxy Views, “Galaxy S7 Caseology Parallax Case Edge Unboxing Review”, <https://www.youtube.com/watch?v=8-a0VNo2kBg>, Published on Apr. 2, 2016, Downloaded on Jan. 13, 2020.

“Spigen Rugged Armor iPhone SE Case with Resilient Shock Absorption and Carbon Fiber Design for iPhone SE 2016—Black”, <https://www.amazon.com/dp/B01BEDNUDK>, earliest review date of Apr. 10, 2016, downloaded on Jan. 15, 2019.

“Caseology Parallax for Apple iPhone 6S Case (2015) / for iPhone 6 Case (2014)—Mint Green”, <https://www.amazon.com/dp/B01IIQ29PG/>, Earliest review date of Jul. 26, 2016, Downloaded on Nov. 15, 2019.

Clocks, “Received my Spigen Neo Hybrid and Caseology Parallax series”, <https://forums.androidcentral.com/samsung-galaxy-note-7-cases-accessories/710480-received-my-spigen-neo-hybrid-caseology-parallax-series.html>, Published date of Aug. 12, 2016, Downloaded on Jan. 13, 2020.

“Spigen Rugged Armor iPhone 8 Plus/iPhone 7 Plus Case with Resilient Shock Absorption and Carbon Fiber Design for Apple iPhone 8 Plus (2017)/iPhone 7 Plus (2016)—Black”, <https://www.amazon.com/dp/B01GIWGAAC>, earliest review date of Sep. 2, 2016, downloaded on Jul. 17, 2018.

“Caseology Parallax for Apple iPhone 8 Case (2017) / for iPhone 7 Case (2016)—Award Winning Design—Aqua Green”, <https://www.amazon.com/dp/B075DZ6VLG/>, Earliest review date of Sep. 11, 2016, Downloaded on Nov. 15, 2019.

“Spigen Rugged Armor iPhone 8 Case/iPhone 7 Case with Resilient Shock Absorption and Carbon Fiber Design for Apple iPhone 8 (2017)/iPhone 7 (2016)—Black”, <https://www.amazon.com/dp/B01GIVX7TA>, earliest review date of Sep. 11, 2016, downloaded on Jul. 17, 2018.

“Caseology Parallax for iPhone 8 Case (2017) / iPhone 7 Case (2016)—Award Winning Design—Mint Green”, <https://www.amazon.com/Xawy-Caseology-Parallax-Compatible-iPhone/dp/B01JSZNF9U>, earliest review date of Sep. 17, 2016, Downloaded on Nov. 15, 2019.

\* cited by examiner

FIG. 1

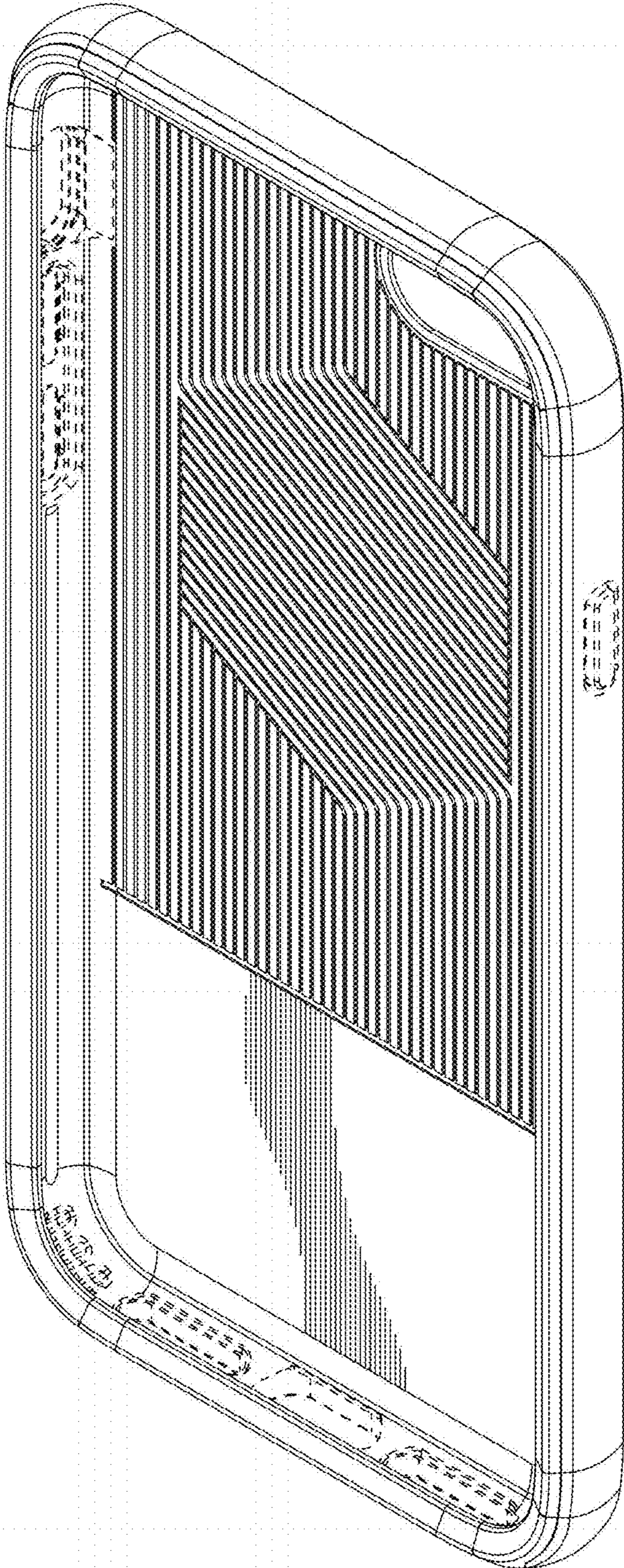

FIG. 2

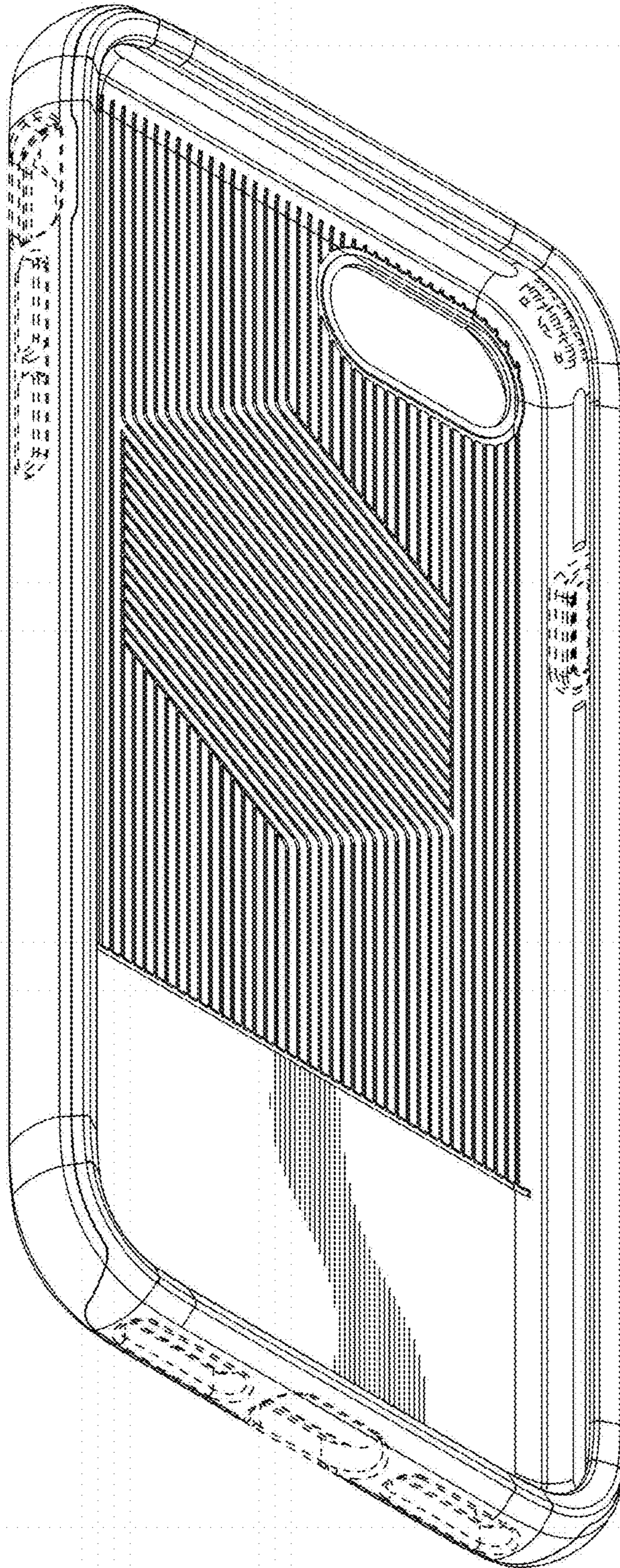

FIG. 3

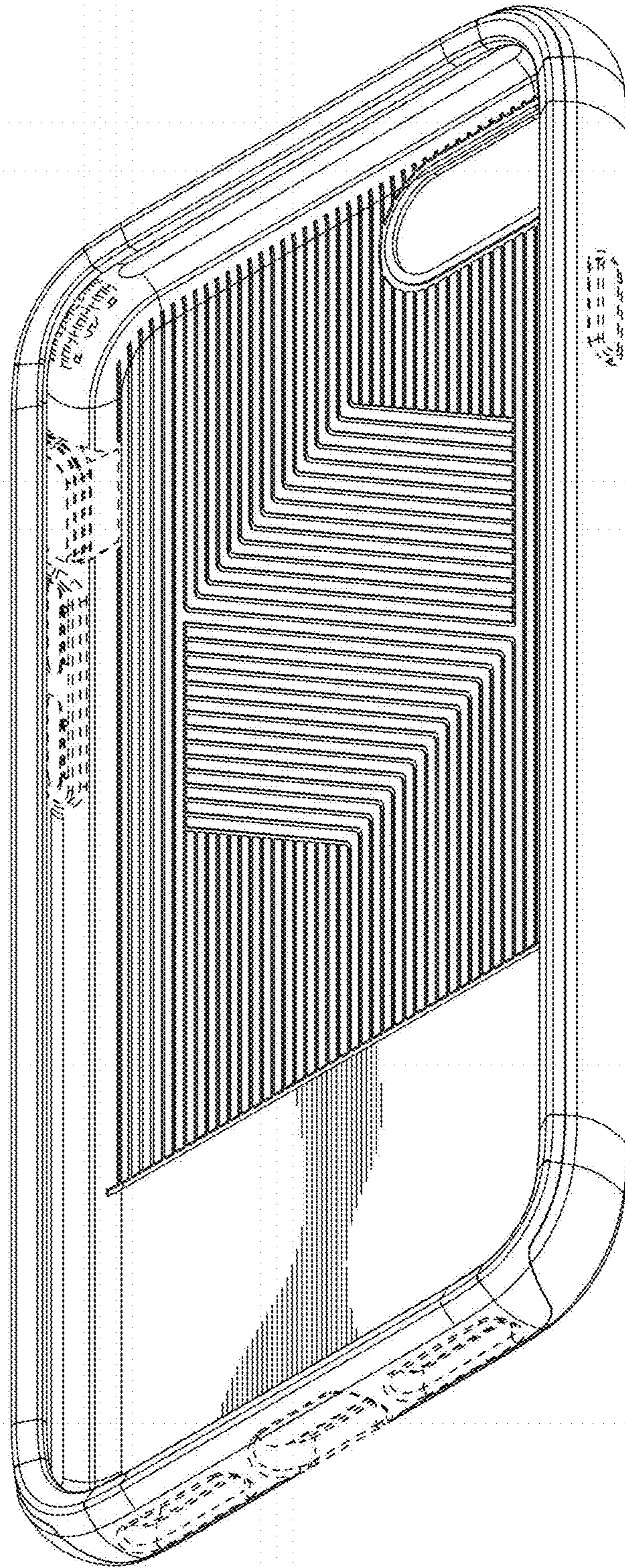

FIG. 4

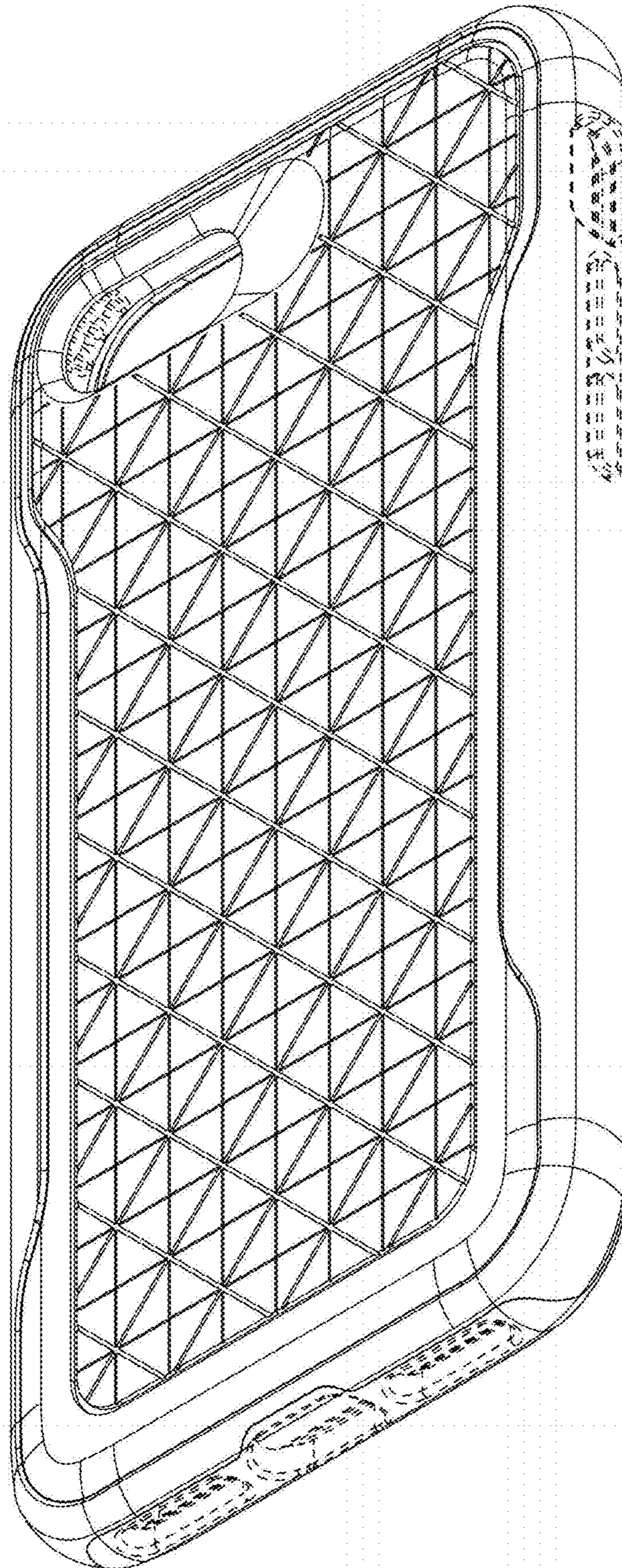

FIG. 5

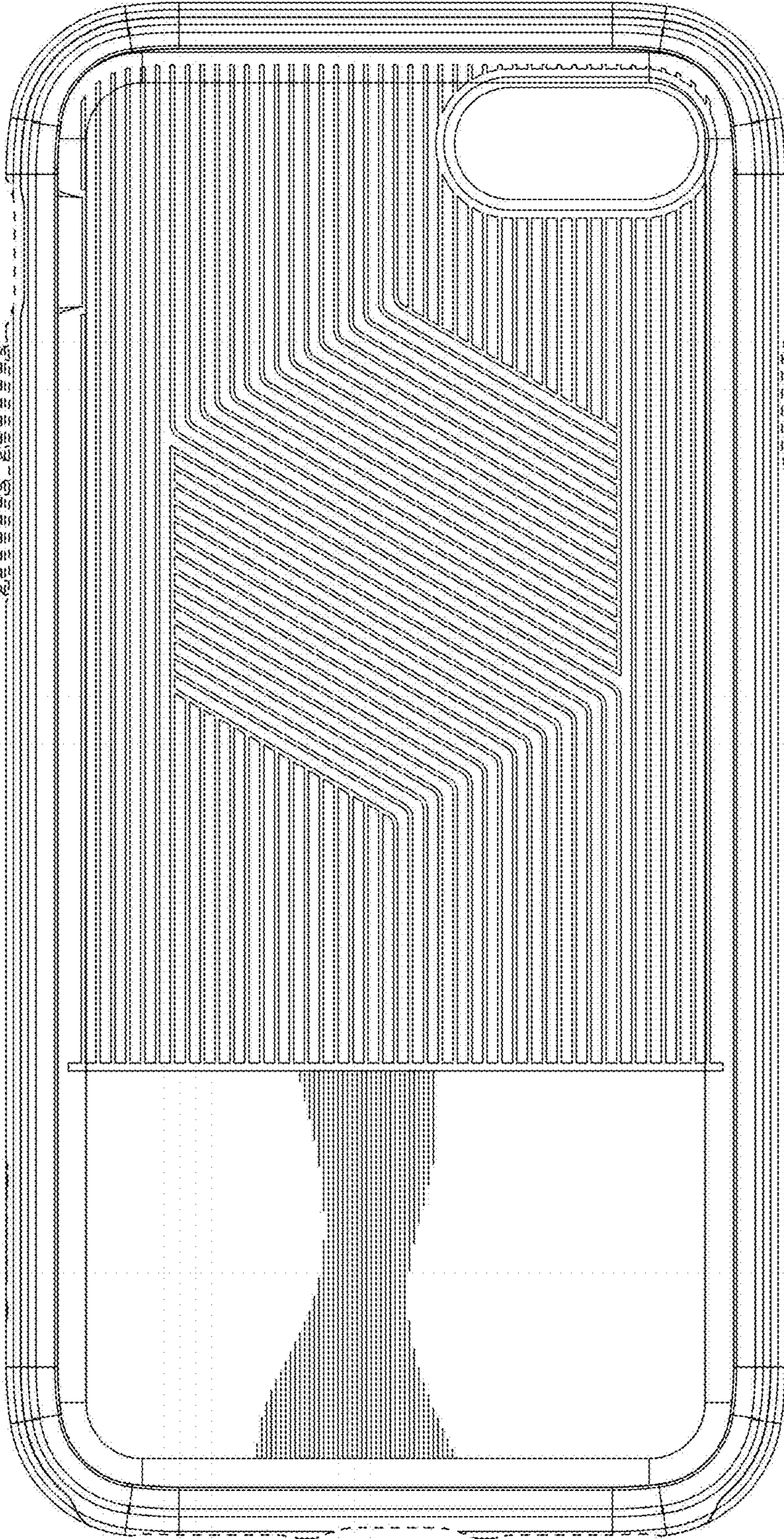

FIG. 6

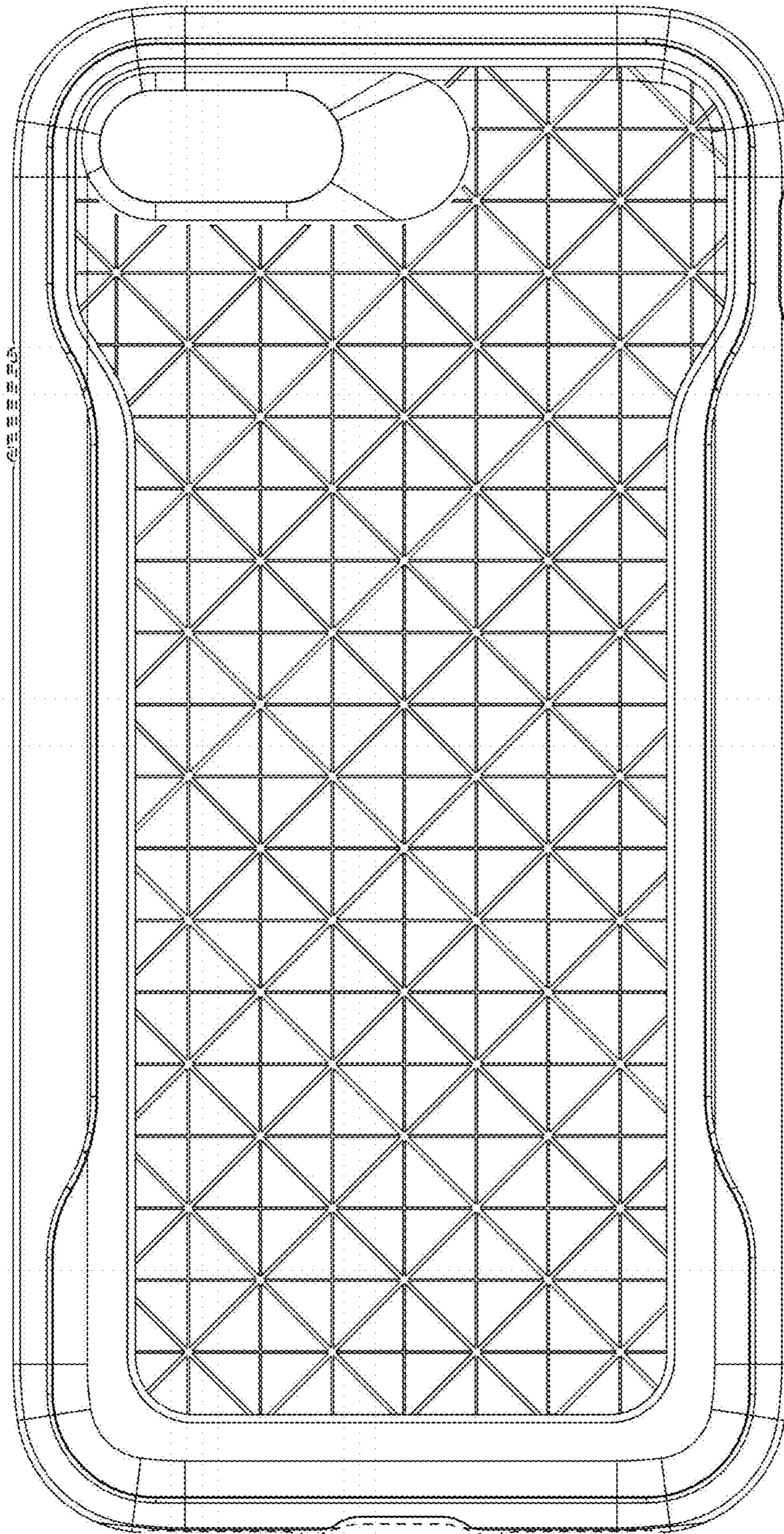



FIG. 7

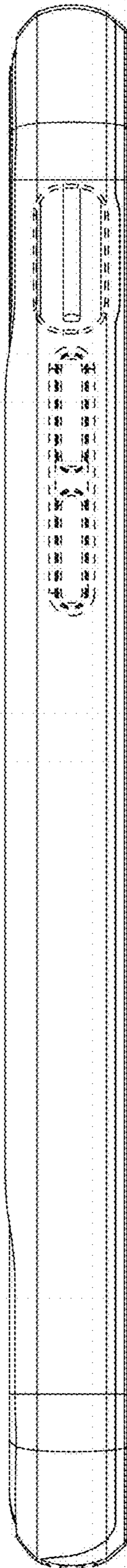

FIG. 8

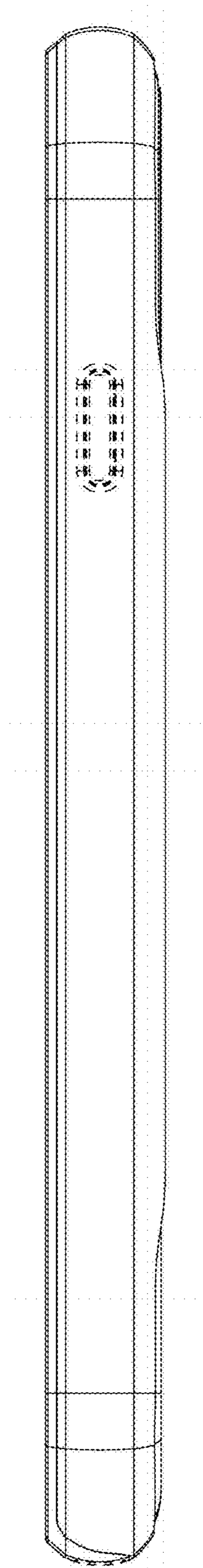

FIG. 9

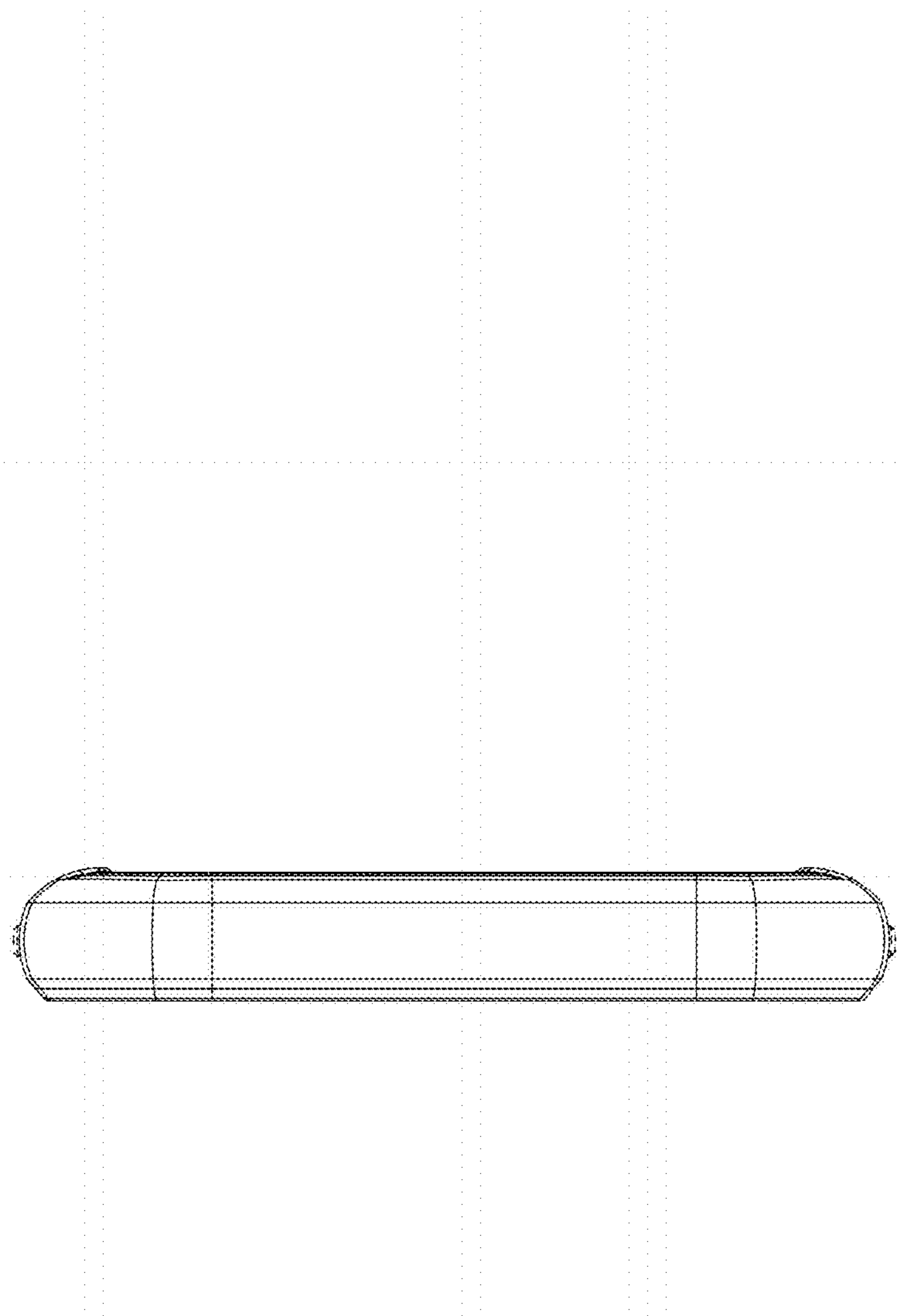

FIG. 10

