



US00D892054S

(12) **United States Design Patent**  
**Langhammer et al.**

(10) **Patent No.:** **US D892,054 S**  
(45) **Date of Patent:** **\*\* Aug. 4, 2020**

(54) **POWER ADAPTER**

**DESCRIPTION**

(71) Applicant: **Amazon Technologies, Inc.**, Seattle, WA (US)  
(72) Inventors: **Heinz-Dominik Langhammer**, San Francisco, CA (US); **Robert Brian Curtis**, San Francisco, CA (US)  
(73) Assignee: **Amazon Technologies, Inc.**, Seattle, WA (US)  
(\*\*) Term: **15 Years**  
(21) Appl. No.: **29/531,964**  
(22) Filed: **Jun. 30, 2015**  
(51) **LOC (12) Cl.** ..... **13-03**  
(52) **U.S. Cl.**  
USPC ..... **D13/137.1**  
(58) **Field of Classification Search**  
USPC ..... D13/137.1–137.4, 138.1–138.2, D13/139.1–139.8, 110, 133, 108, 152; D14/435; 439/131; 340/635; 320/111  
CPC ..... H01R 13/6581; H01R 13/44; H01R 13/6666; H01R 13/2442; H01R 31/0654  
See application file for complete search history.

(56) **References Cited**

**U.S. PATENT DOCUMENTS**

5,761,021 A \* 6/1998 Yu ..... H01R 13/6666 340/635  
D581,870 S \* 12/2008 Zhou ..... D13/137.2  
D582,346 S \* 12/2008 Zhou ..... D13/137.2

(Continued)

*Primary Examiner* — Rhea Shields

(74) *Attorney, Agent, or Firm* — Lee & Hayes, P.C.

(57) **CLAIM**

The ornamental design for a power adapter, as shown and described.

FIG. 1 is a back perspective view of a first embodiment of the power adapter;  
FIG. 2 is a front perspective view thereof;  
FIG. 3 is a top view thereof;  
FIG. 4 is bottom view thereof;  
FIG. 5 is a left-side view thereof;  
FIG. 6 is a right-side view thereof;  
FIG. 7 is a back view thereof; and  
FIG. 8 is a front view thereof.  
FIG. 9 is a back perspective view of a second embodiment of the power adapter;  
FIG. 10 is a front perspective view thereof;  
FIG. 11 is a top view thereof;  
FIG. 12 is bottom view thereof;  
FIG. 13 is a left-side view thereof;  
FIG. 14 is a right-side view thereof;  
FIG. 15 is a back view thereof; and  
FIG. 16 is a front view thereof.  
FIG. 17 is a back perspective view of a third embodiment of the power adapter;  
FIG. 18 is a front perspective view thereof;  
FIG. 19 is a top view thereof;  
FIG. 20 is bottom view thereof;  
FIG. 21 is a left-side view thereof;  
FIG. 22 is a right-side view thereof;  
FIG. 23 is a back view thereof; and  
FIG. 24 is a front view thereof.  
FIG. 25 is a back perspective view of a fourth embodiment of the power adapter;  
FIG. 26 is a front perspective view thereof;  
FIG. 27 is a top view thereof;  
FIG. 28 is bottom view thereof;  
FIG. 29 is a left-side view thereof;  
FIG. 30 is a right-side view thereof;  
FIG. 31 is a back view thereof; and,  
FIG. 32 is a front view thereof.  
The broken lines depict portions of the power adapter which form no part of the claimed design.

**1 Claim, 28 Drawing Sheets**

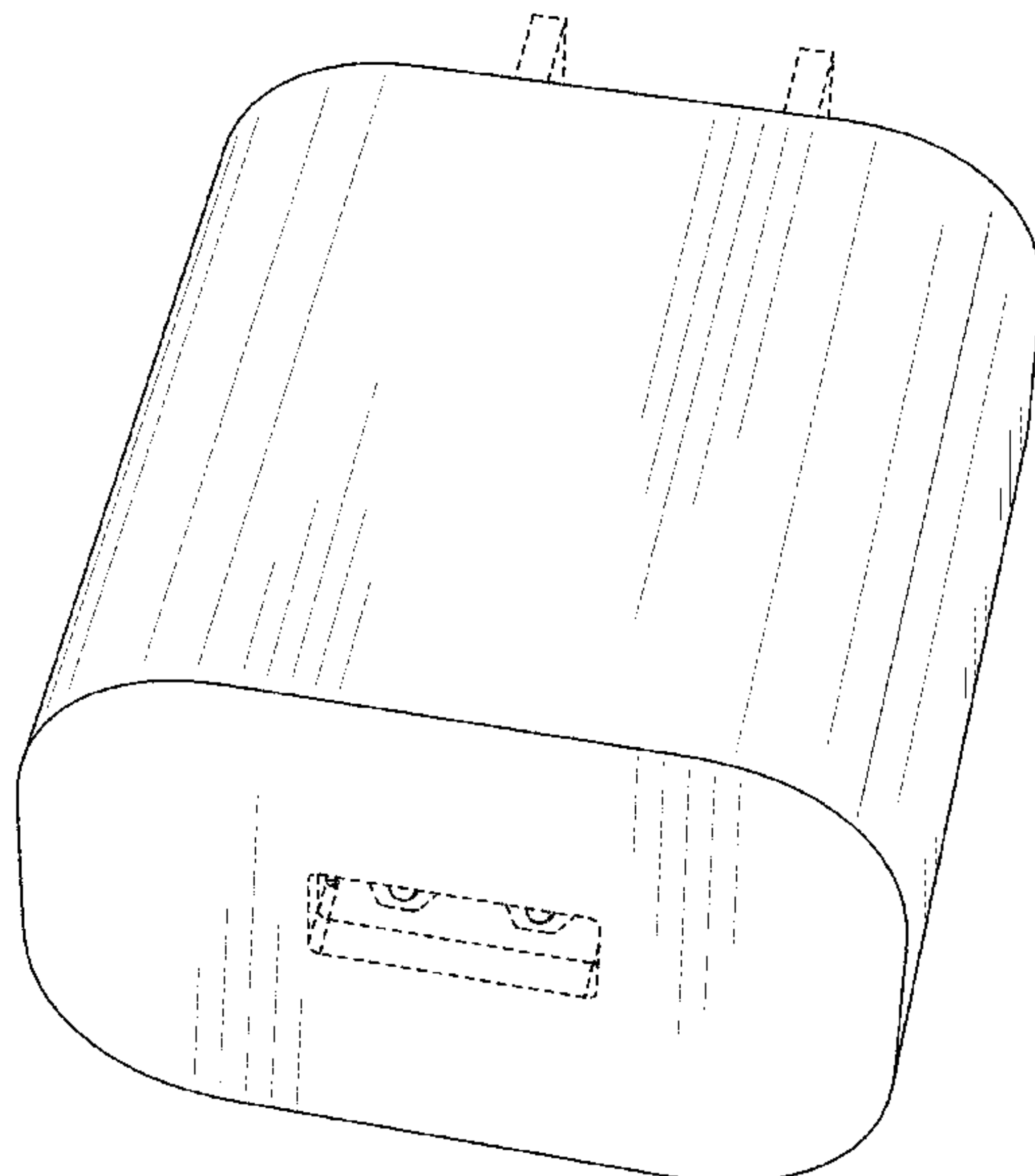

(56)

References Cited

U.S. PATENT DOCUMENTS

D601,500 S \* 10/2009 Green ..... D13/110  
 D610,992 S \* 3/2010 Fahrendorff ..... D13/138.1  
 D610,993 S \* 3/2010 Fahrendorff ..... D13/138.1  
 D610,994 S \* 3/2010 Fahrendorff ..... D13/138.1  
 D611,415 S \* 3/2010 Andre ..... D13/108  
 D617,275 S \* 6/2010 Fahrendorff ..... D13/138.1  
 D620,889 S \* 8/2010 Smith ..... D13/108  
 D623,136 S \* 9/2010 Andre ..... D13/108  
 D627,729 S \* 11/2010 Smith ..... D13/108  
 D635,919 S \* 4/2011 Ahola ..... D13/138.1  
 D635,920 S \* 4/2011 Smith ..... D13/138.1  
 D640,631 S \* 6/2011 Smith ..... D13/138.1  
 D643,807 S \* 8/2011 Jiang ..... D13/103  
 8,057,265 B2 \* 11/2011 Youssefi-Shams .... H01R 13/44  
 439/655  
 D653,213 S \* 1/2012 Andre ..... D13/138.1  
 8,113,855 B2 \* 2/2012 Green ..... H01R 13/44  
 439/131  
 D657,310 S \* 4/2012 Fahrendorff ..... D13/110  
 D663,267 S \* 7/2012 Kim ..... D13/110  
 D664,093 S \* 7/2012 Andre ..... D13/138.1  
 D665,348 S \* 8/2012 Ledbetter ..... D13/110  
 D669,434 S \* 10/2012 Kim ..... D13/110  
 D671,489 S \* 11/2012 Zaslavsky ..... D13/110  
 D675,158 S \* 1/2013 Smith ..... D13/110  
 D675,159 S \* 1/2013 Smith ..... D13/110  
 D676,810 S \* 2/2013 Smith ..... D13/110  
 D680,070 S \* 4/2013 Zaslavsky ..... D13/110

D680,492 S \* 4/2013 Smith ..... D13/110  
 D681,551 S \* 5/2013 Zaslavsky ..... D13/110  
 D683,314 S \* 5/2013 Andre ..... D13/108  
 D686,988 S \* 7/2013 Fawkes ..... D13/110  
 D689,819 S \* 9/2013 Olsson ..... D13/110  
 D693,299 S \* 11/2013 Zaslavsky ..... D13/110  
 D693,767 S \* 11/2013 Zaslavsky ..... D13/110  
 D695,693 S \* 12/2013 Lee ..... D13/152  
 D701,835 S \* 4/2014 Byrne ..... D13/138.2  
 D711,823 S \* 8/2014 Akana ..... D13/110  
 D716,231 S \* 10/2014 Byrne ..... D13/138.2  
 D716,735 S \* 11/2014 Byrne ..... D13/138.2  
 D727,846 S \* 4/2015 Wen ..... D13/110  
 D740,227 S \* 10/2015 Symons ..... D13/137.4  
 D740,751 S \* 10/2015 Akana ..... D13/110  
 D749,046 S \* 2/2016 Curry ..... H01R 13/6581  
 D13/133  
 D750,563 S \* 3/2016 Hedderich ..... D13/137.1  
 D751,039 S \* 3/2016 Ptok ..... D13/138.1  
 D763,190 S \* 8/2016 Akana ..... D13/110  
 D764,410 S \* 8/2016 Alesi ..... D13/110  
 D765,028 S \* 8/2016 Alesi ..... D13/110  
 D772,160 S \* 11/2016 Roberts ..... D13/110  
 D778,835 S \* 2/2017 Akana ..... D13/110  
 D787,443 S \* 5/2017 Chiang ..... D13/110  
 D790,464 S \* 6/2017 He ..... D13/110  
 D792,409 S \* 7/2017 Shim ..... D14/435  
 2007/0229025 A1 \* 10/2007 Tsai ..... H01R 13/2442  
 320/111  
 2009/0289596 A1 \* 11/2009 McGinley ..... H01R 31/065  
 320/111

\* cited by examiner

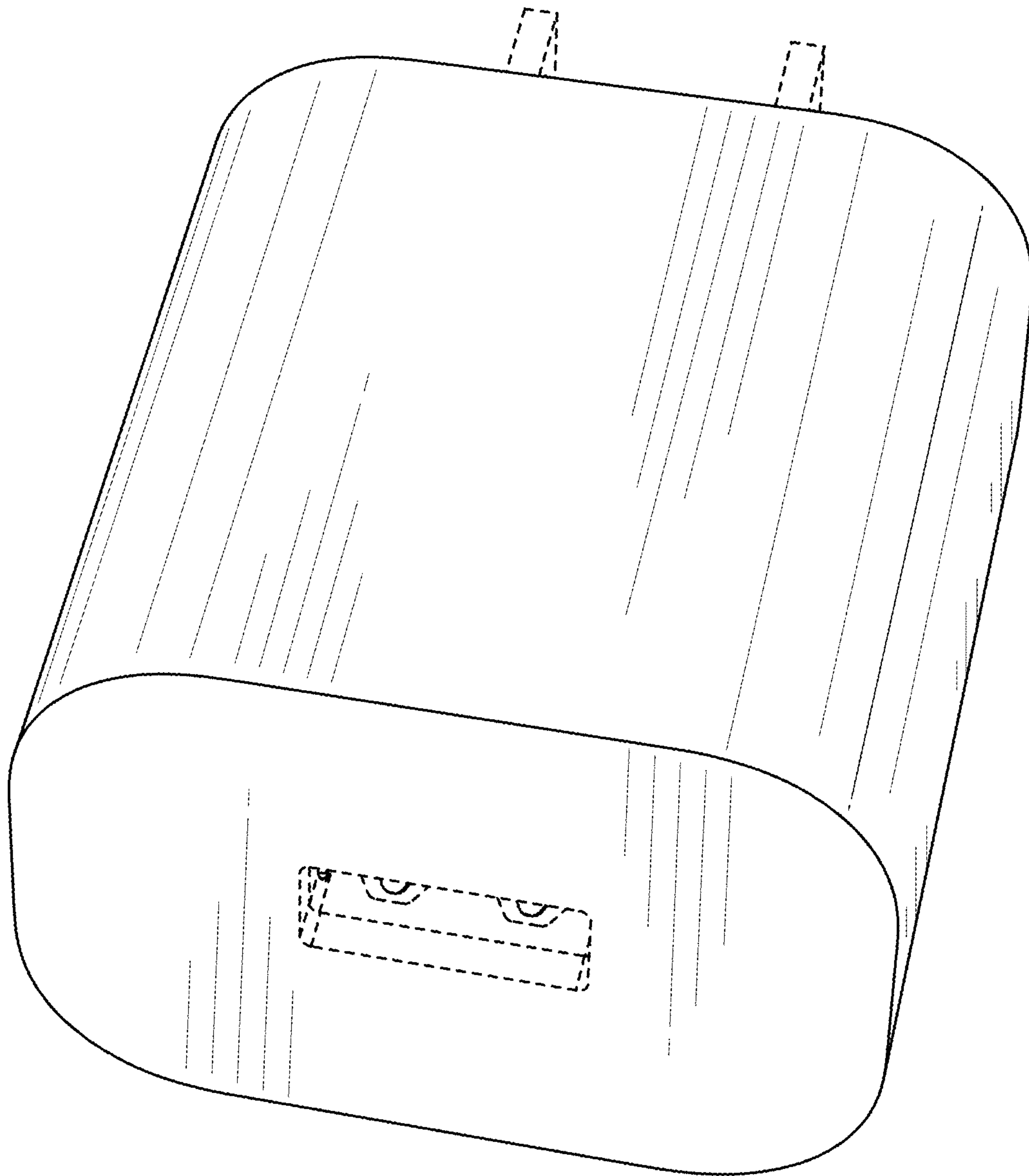

FIG. 1

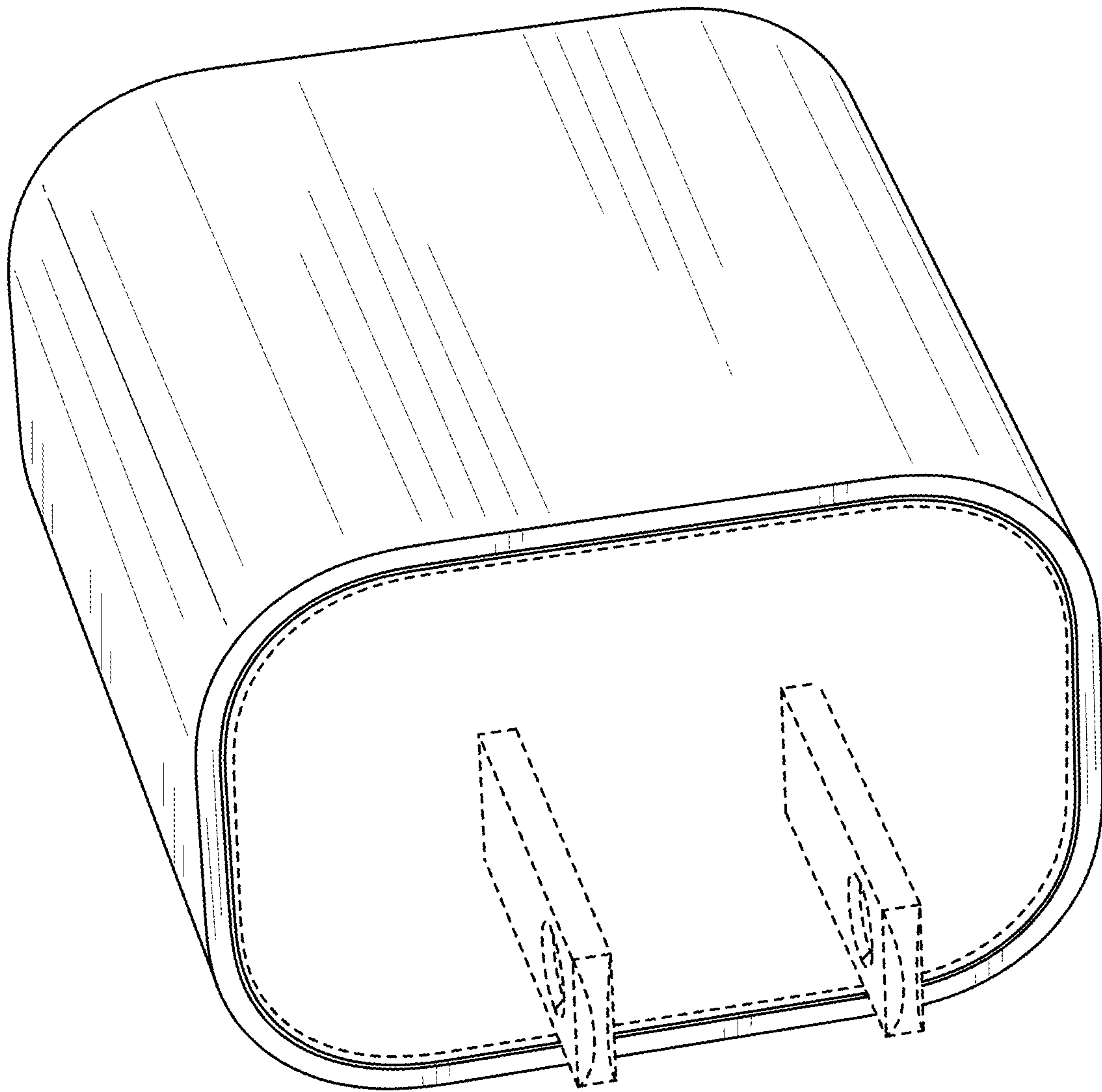

FIG. 2



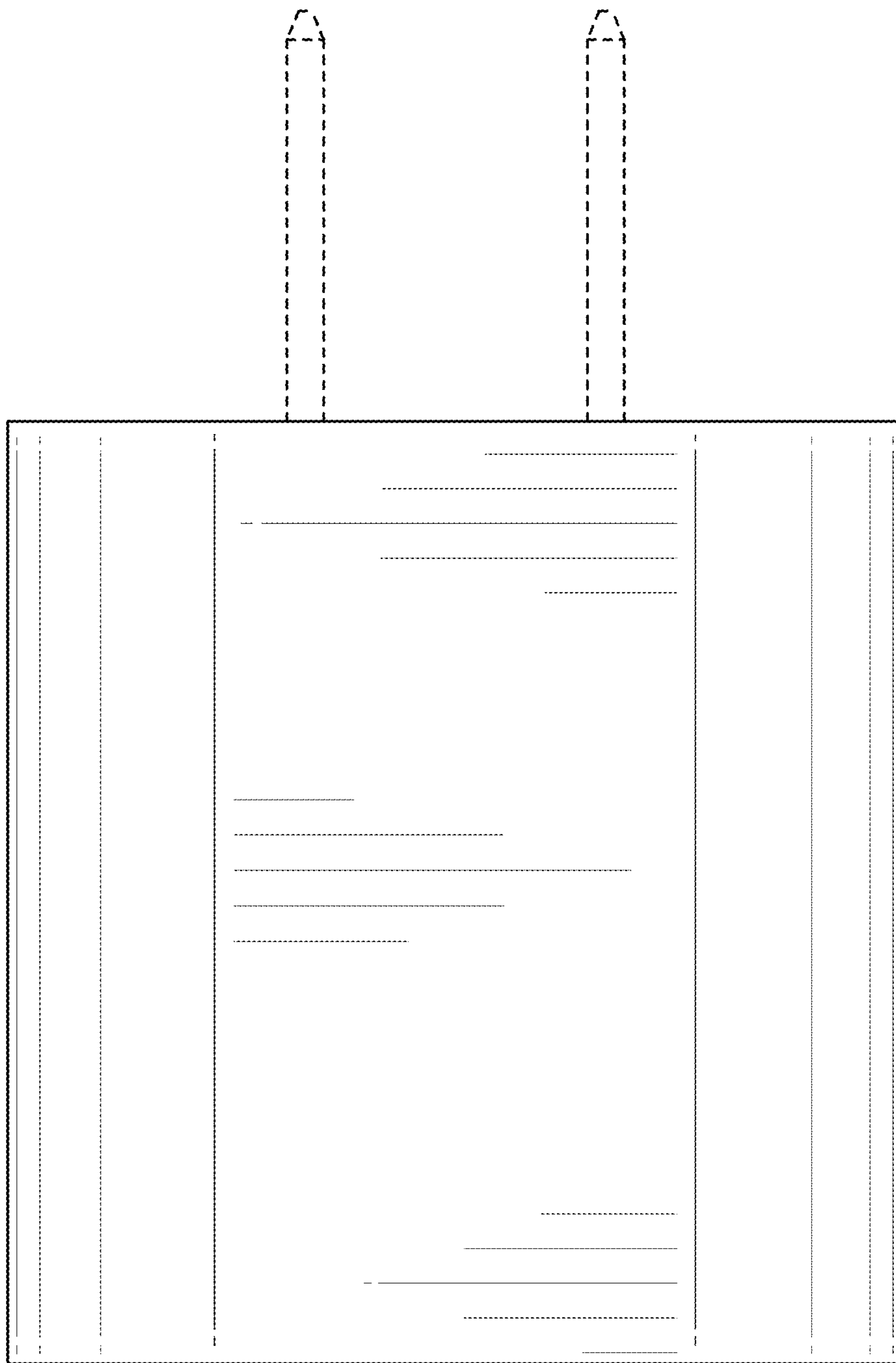

FIG. 3

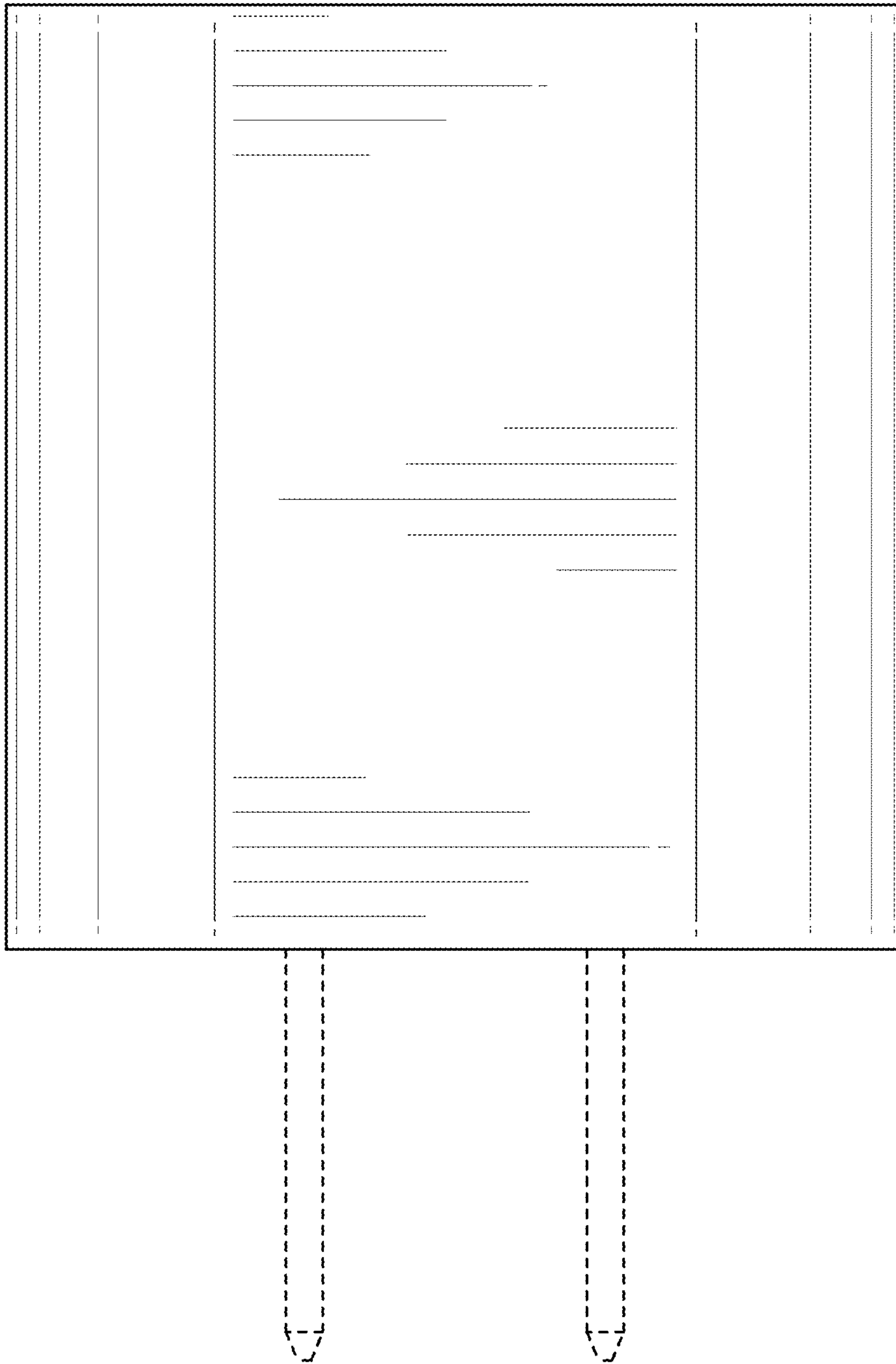

FIG. 4

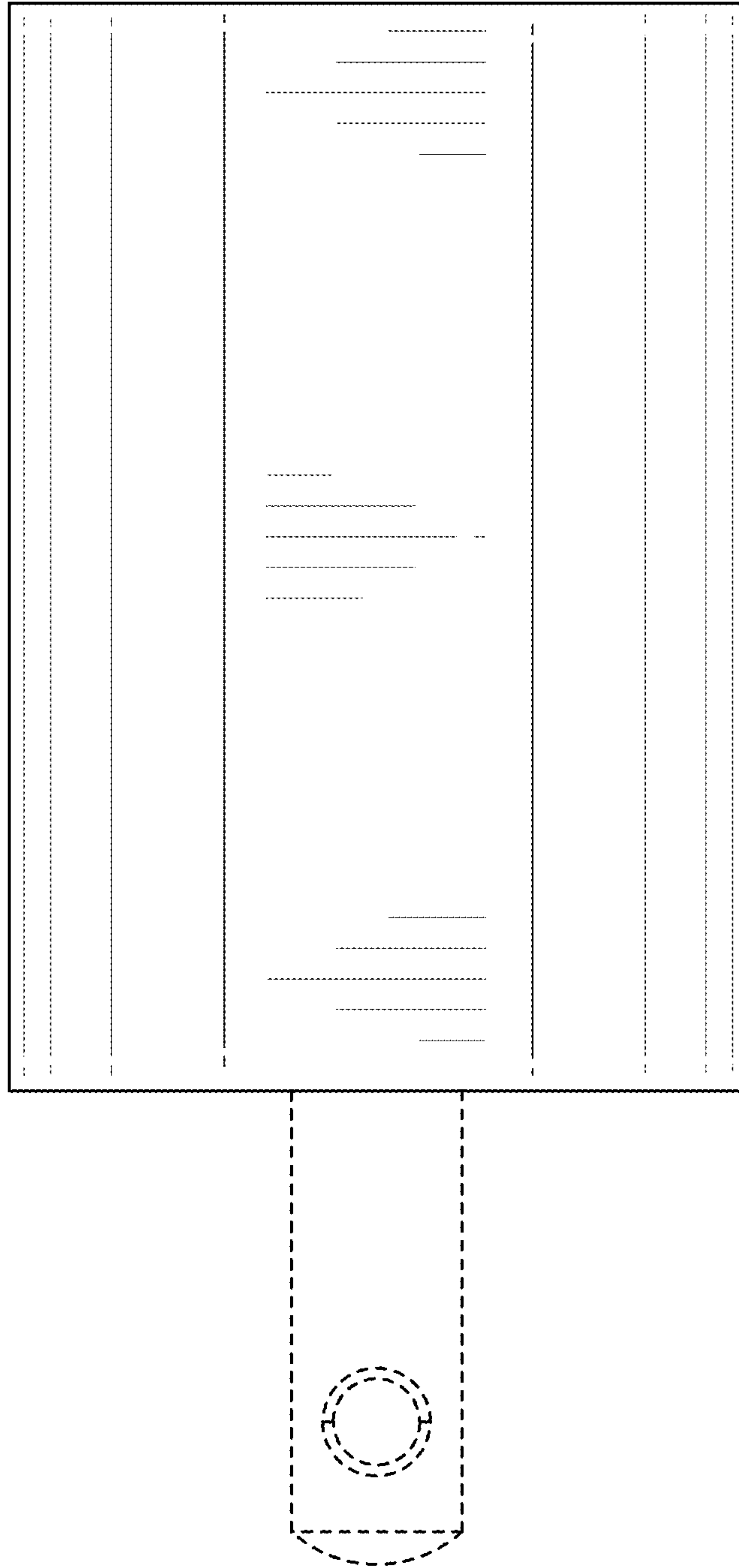

FIG. 5

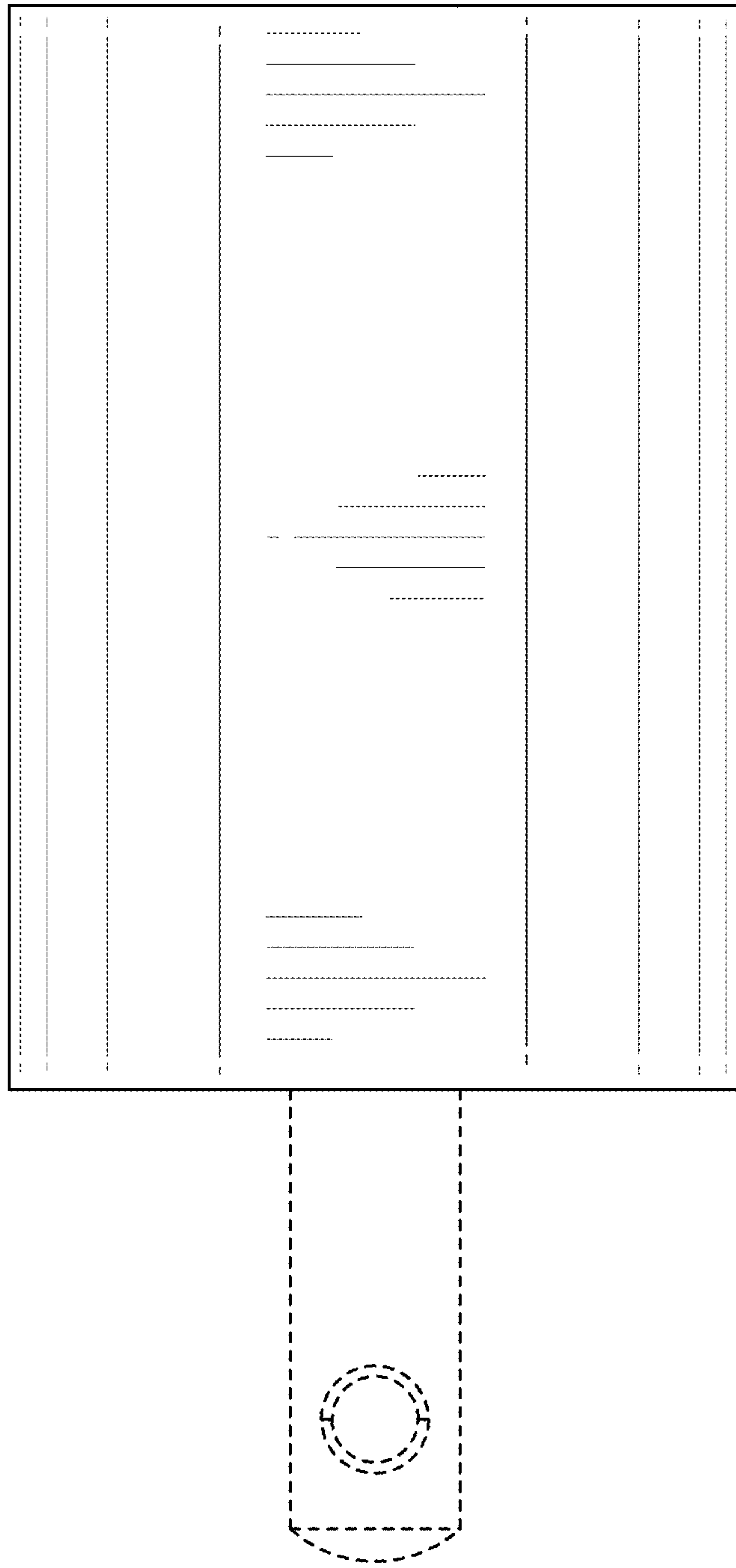

FIG. 6



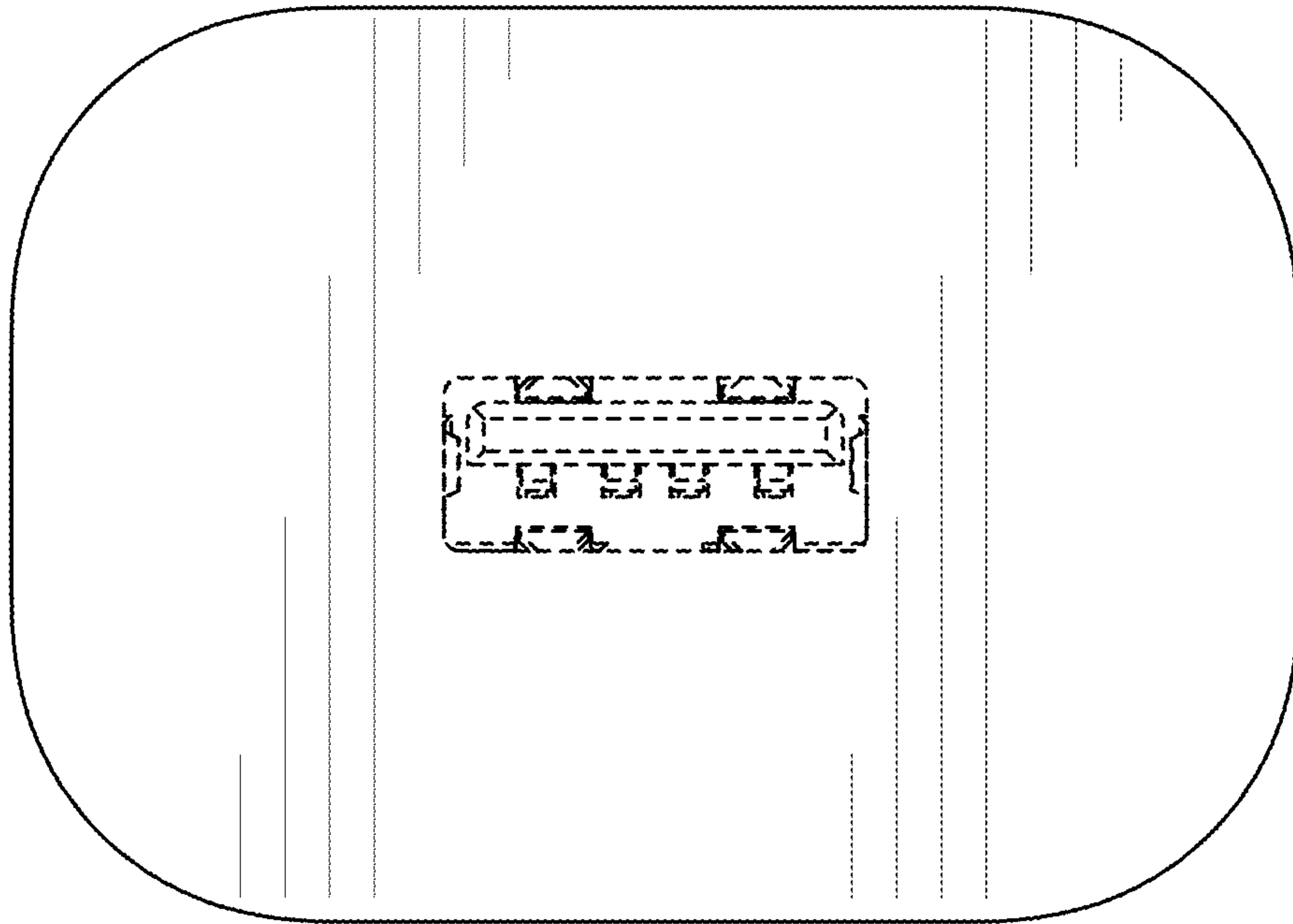

FIG. 7

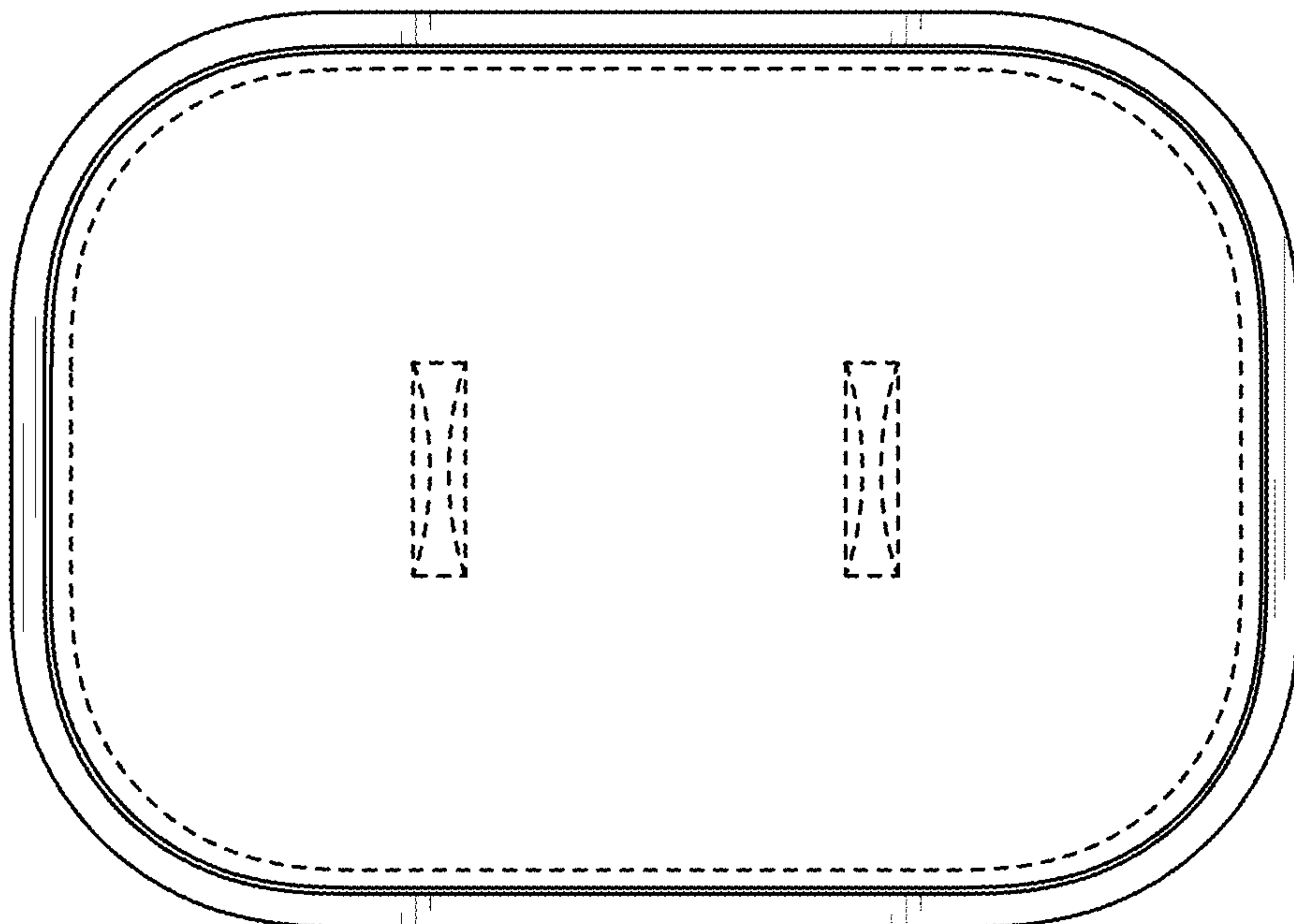

FIG. 8

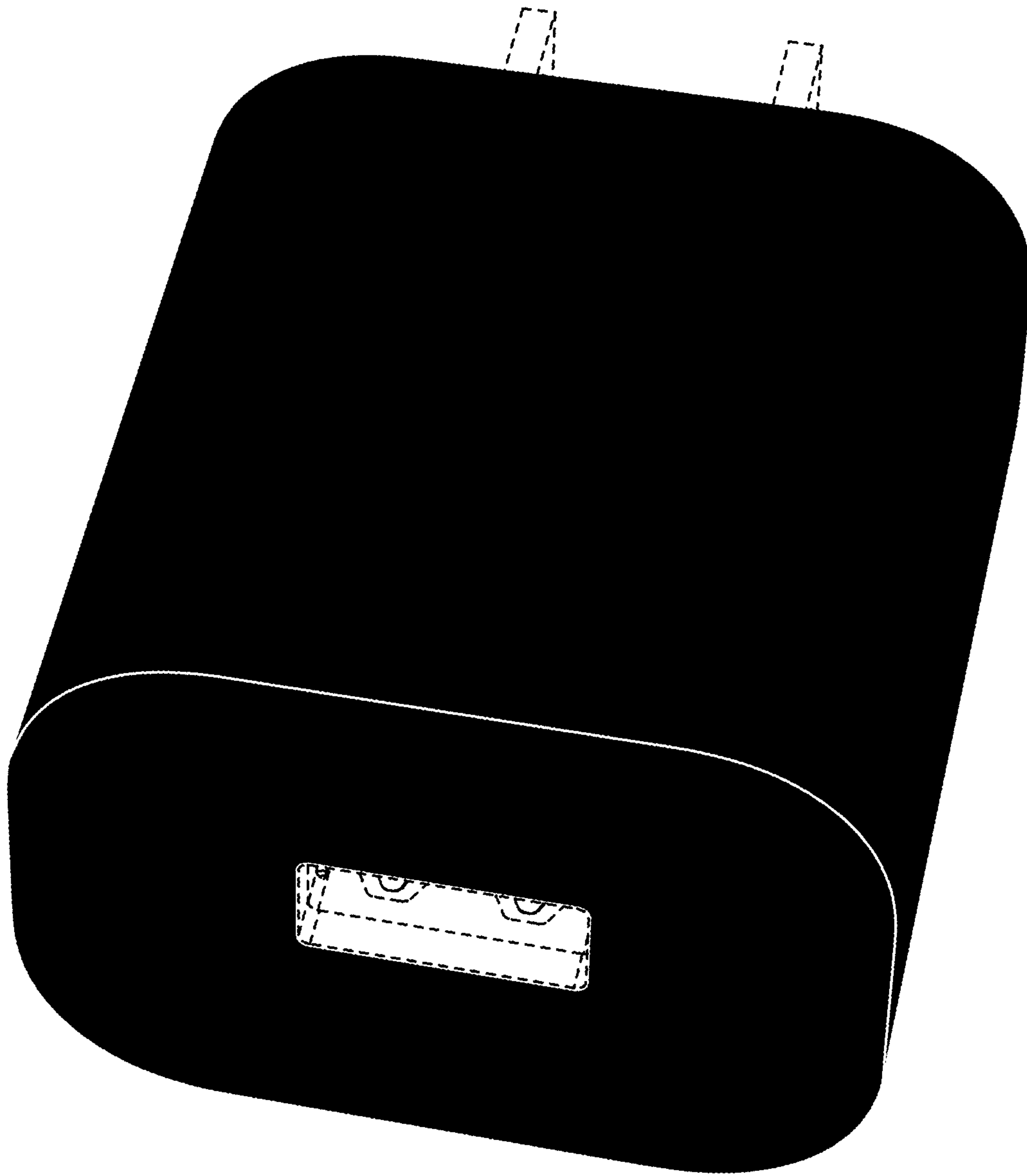

FIG. 9

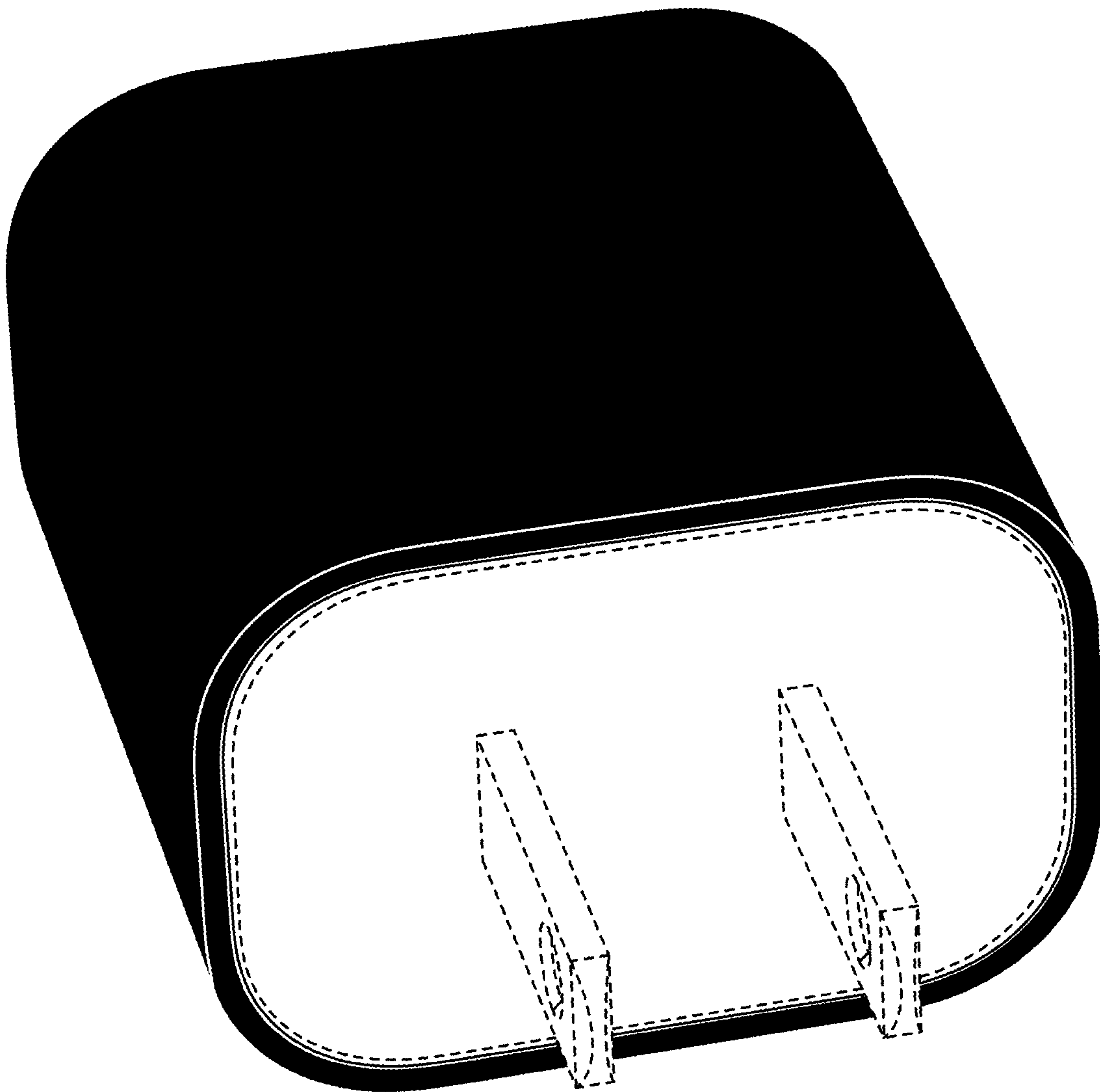

FIG. 10

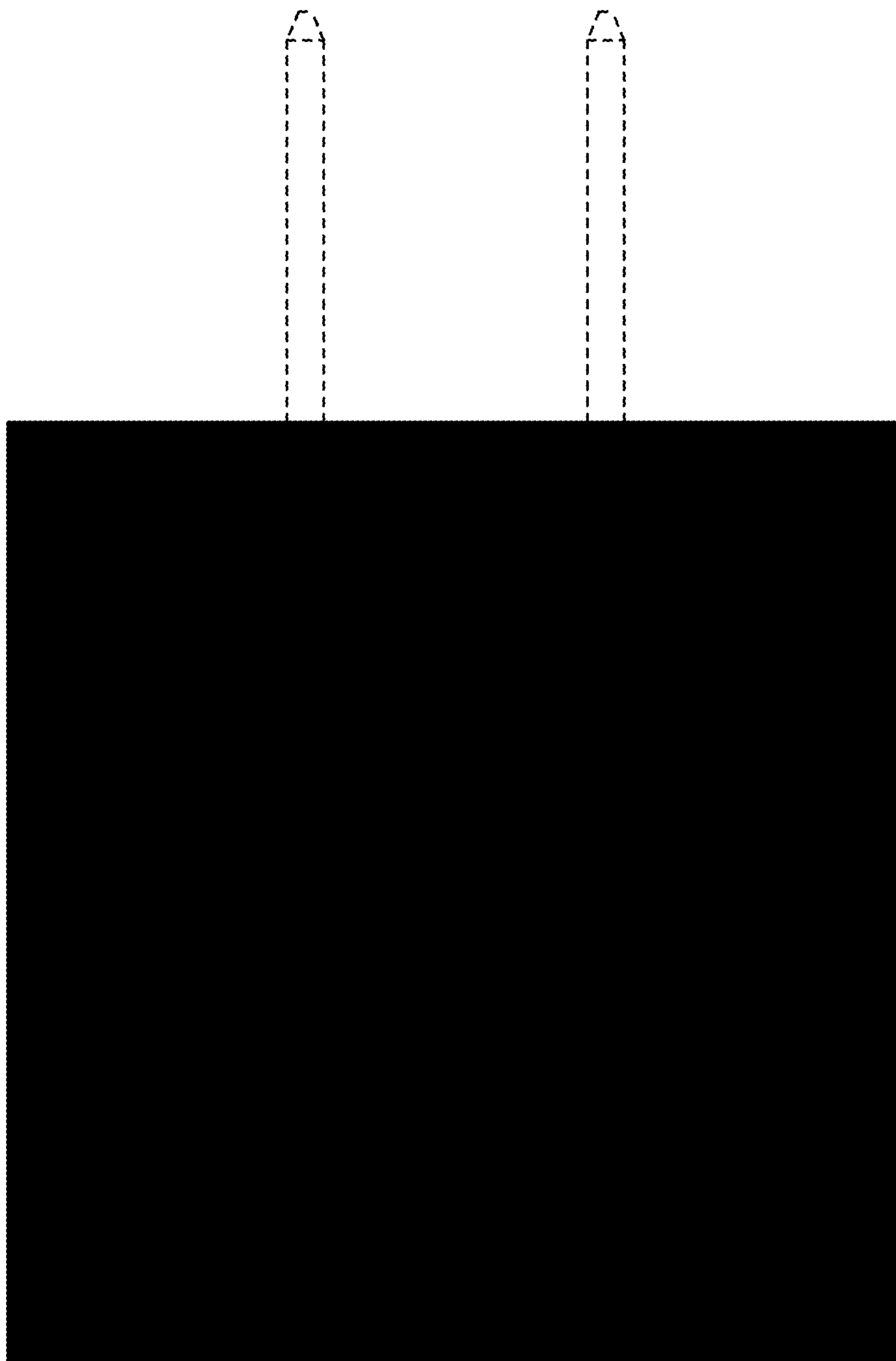

FIG. 11

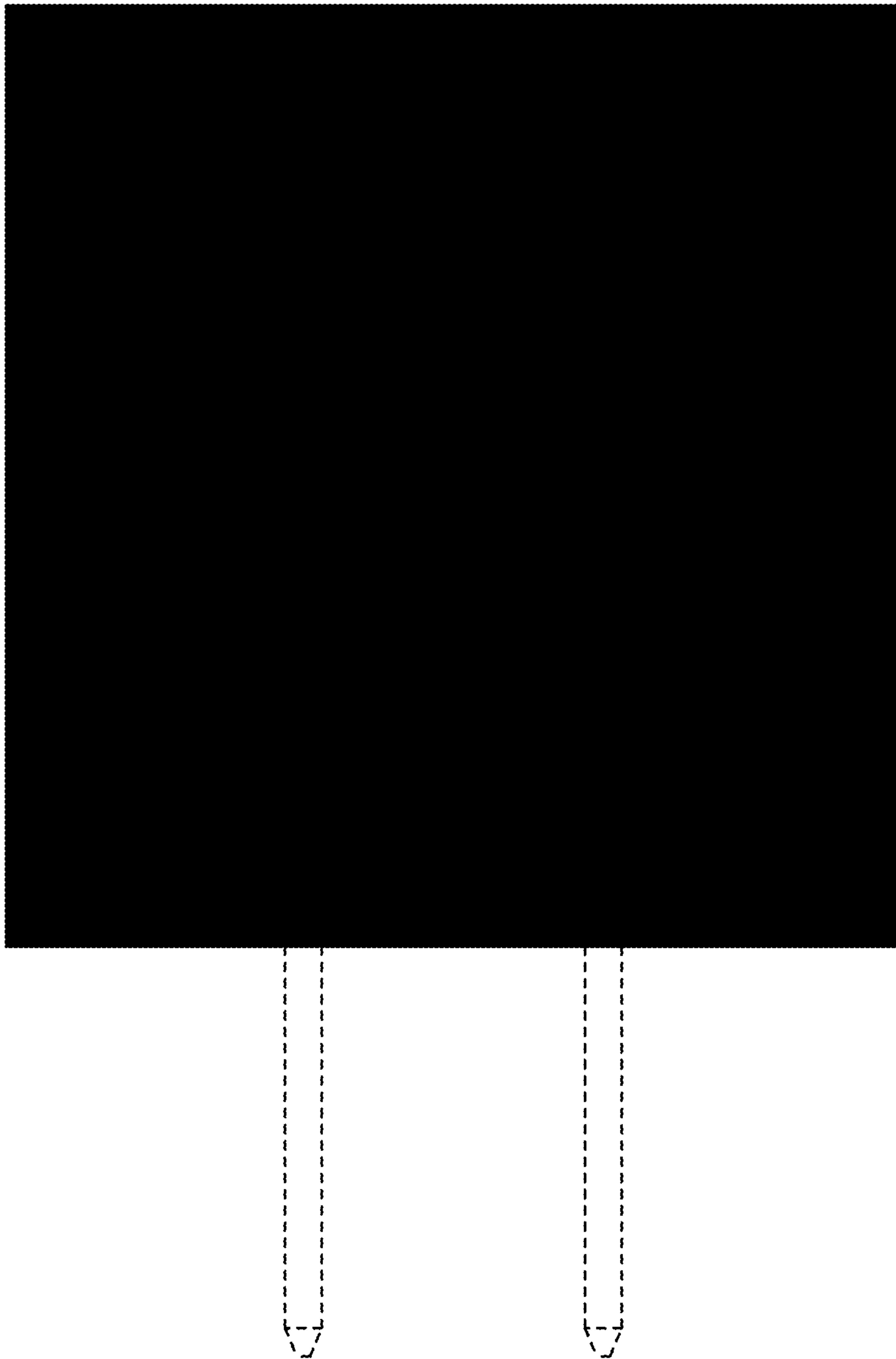

FIG. 12

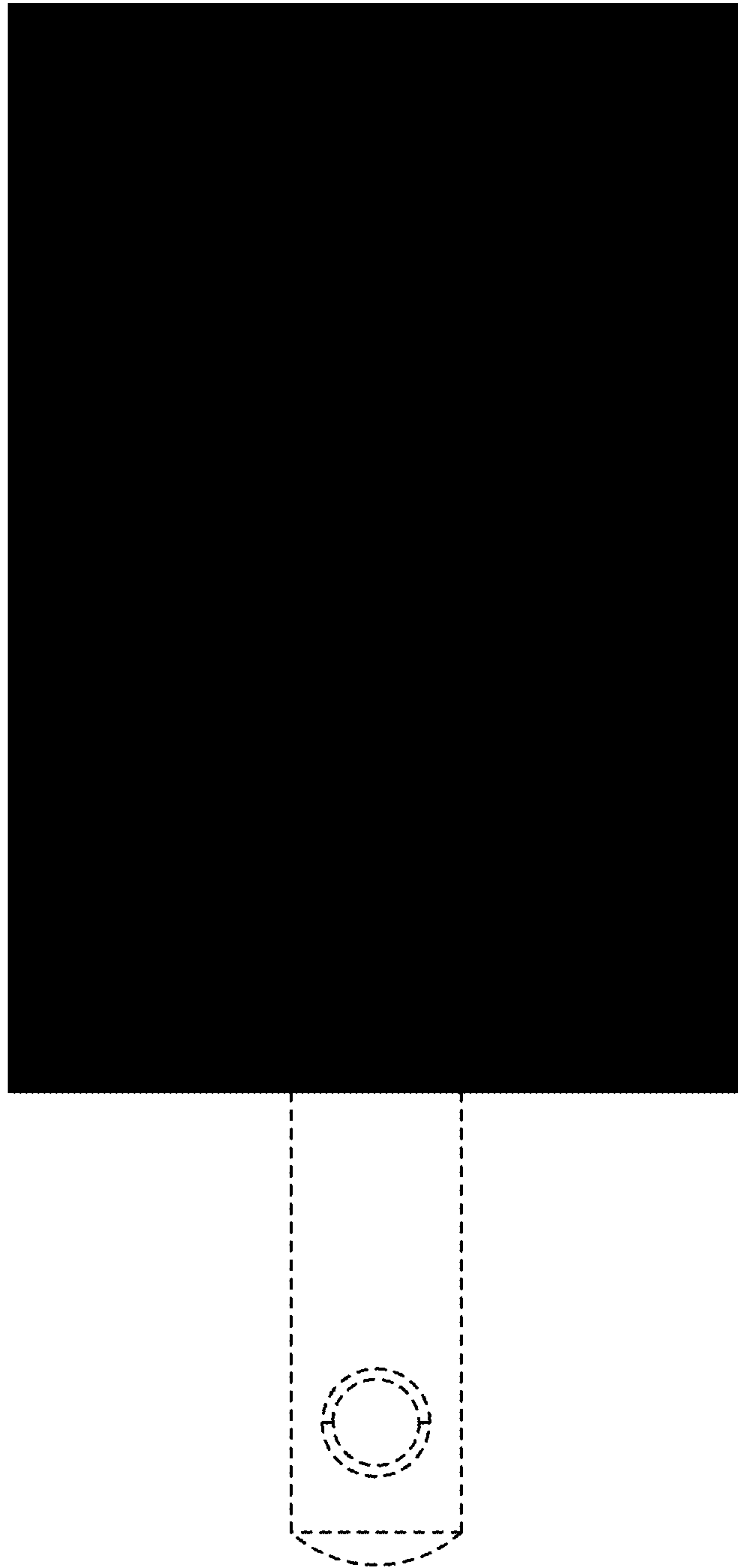

FIG. 13



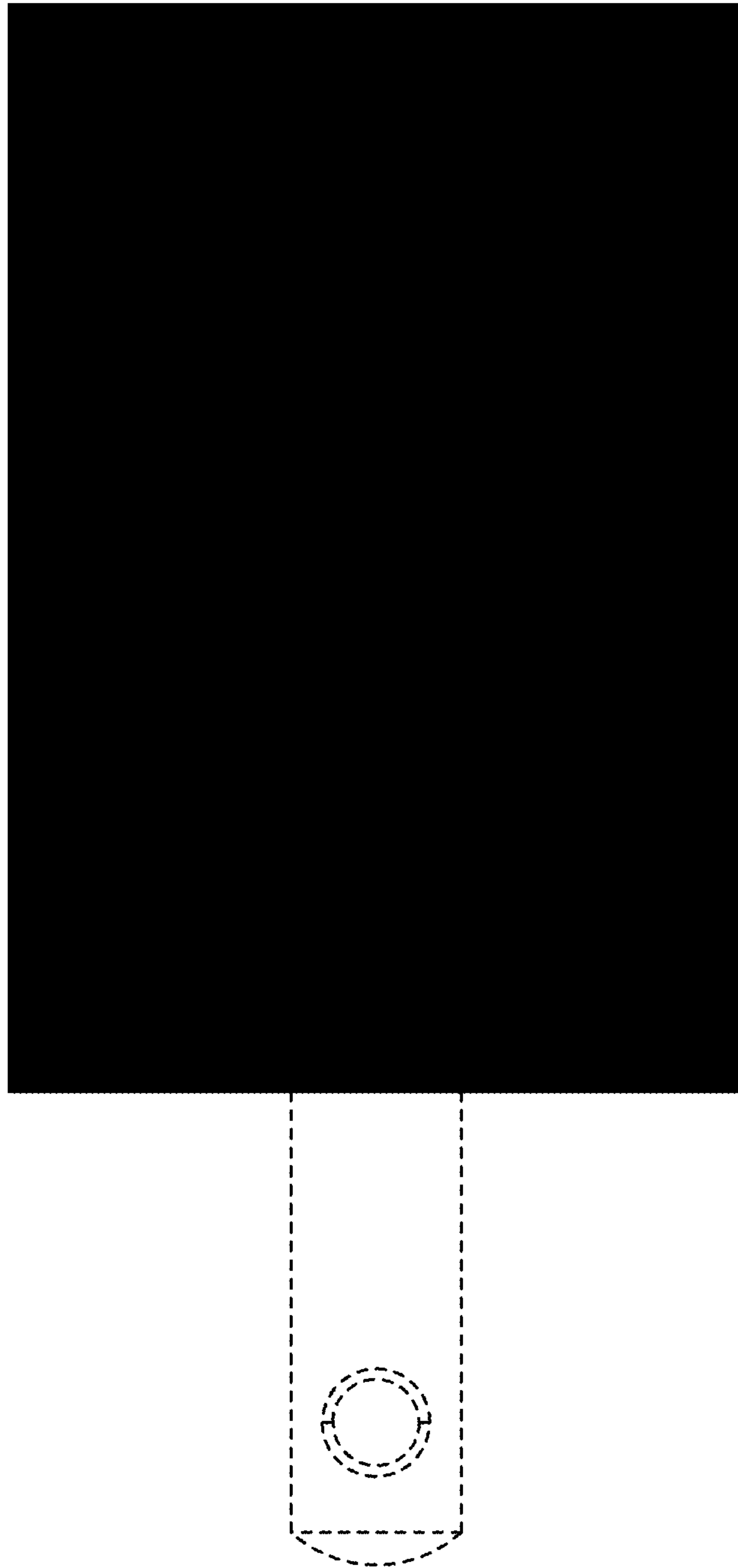

FIG. 14

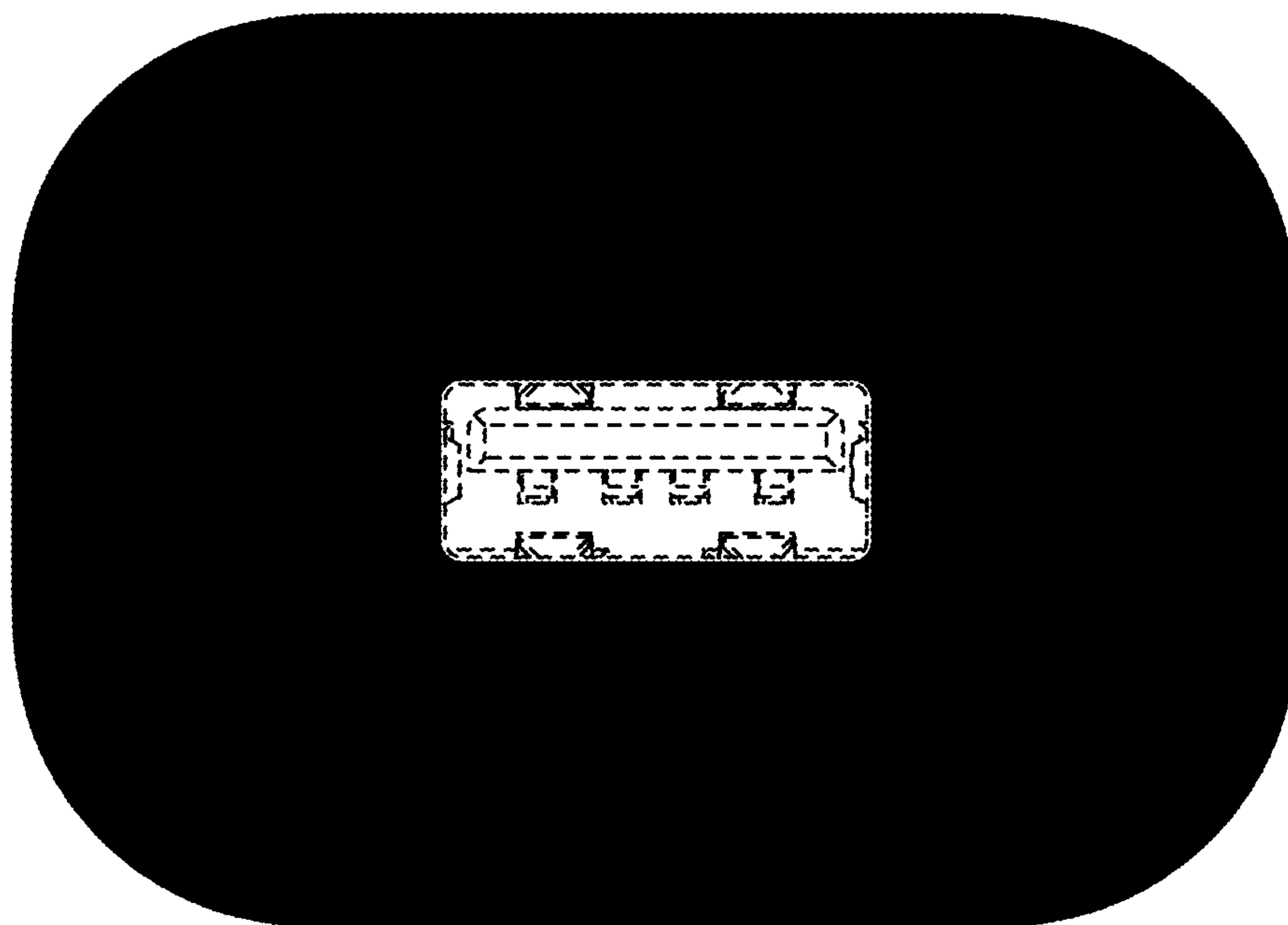

FIG. 15

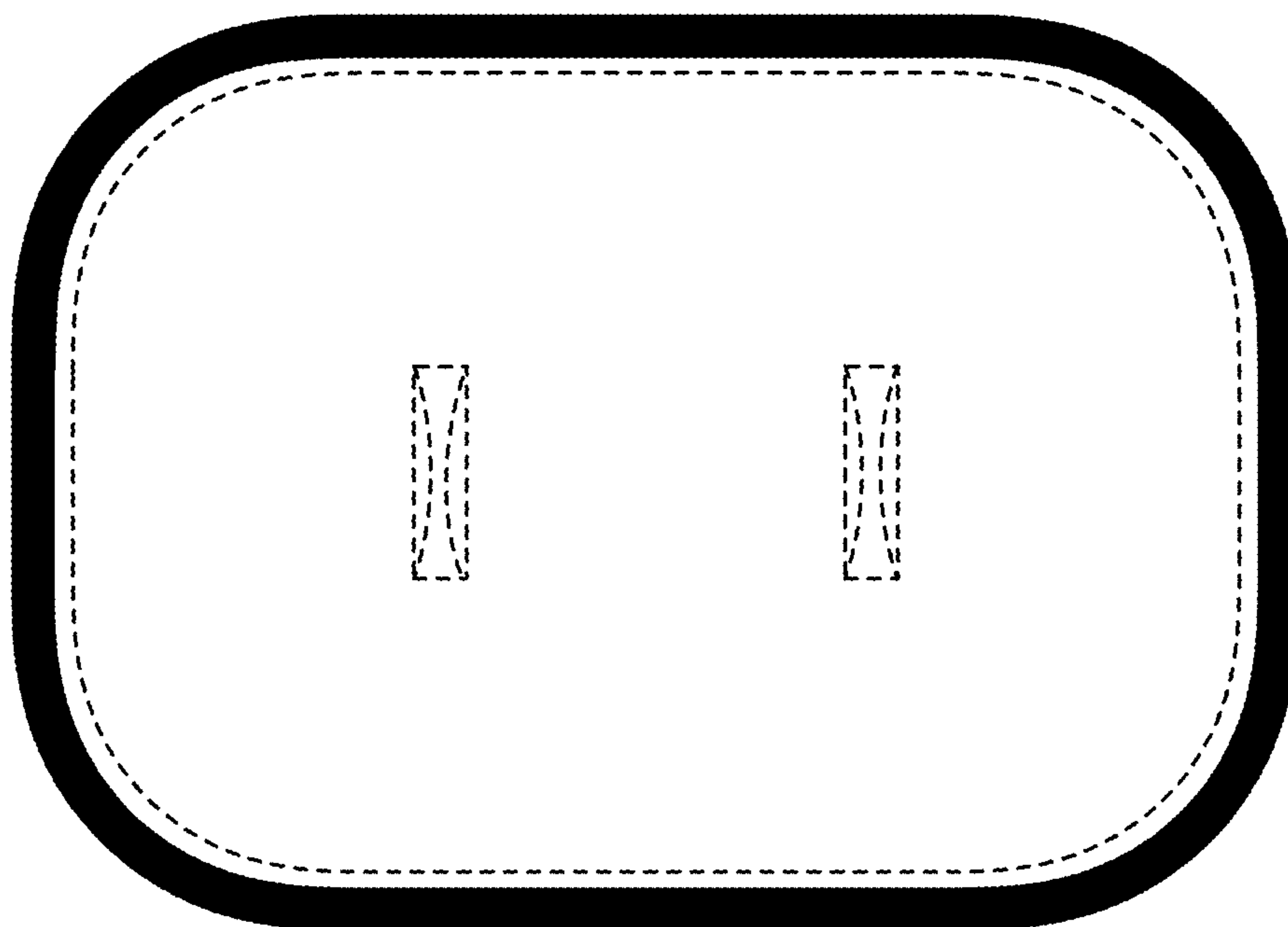

FIG. 16

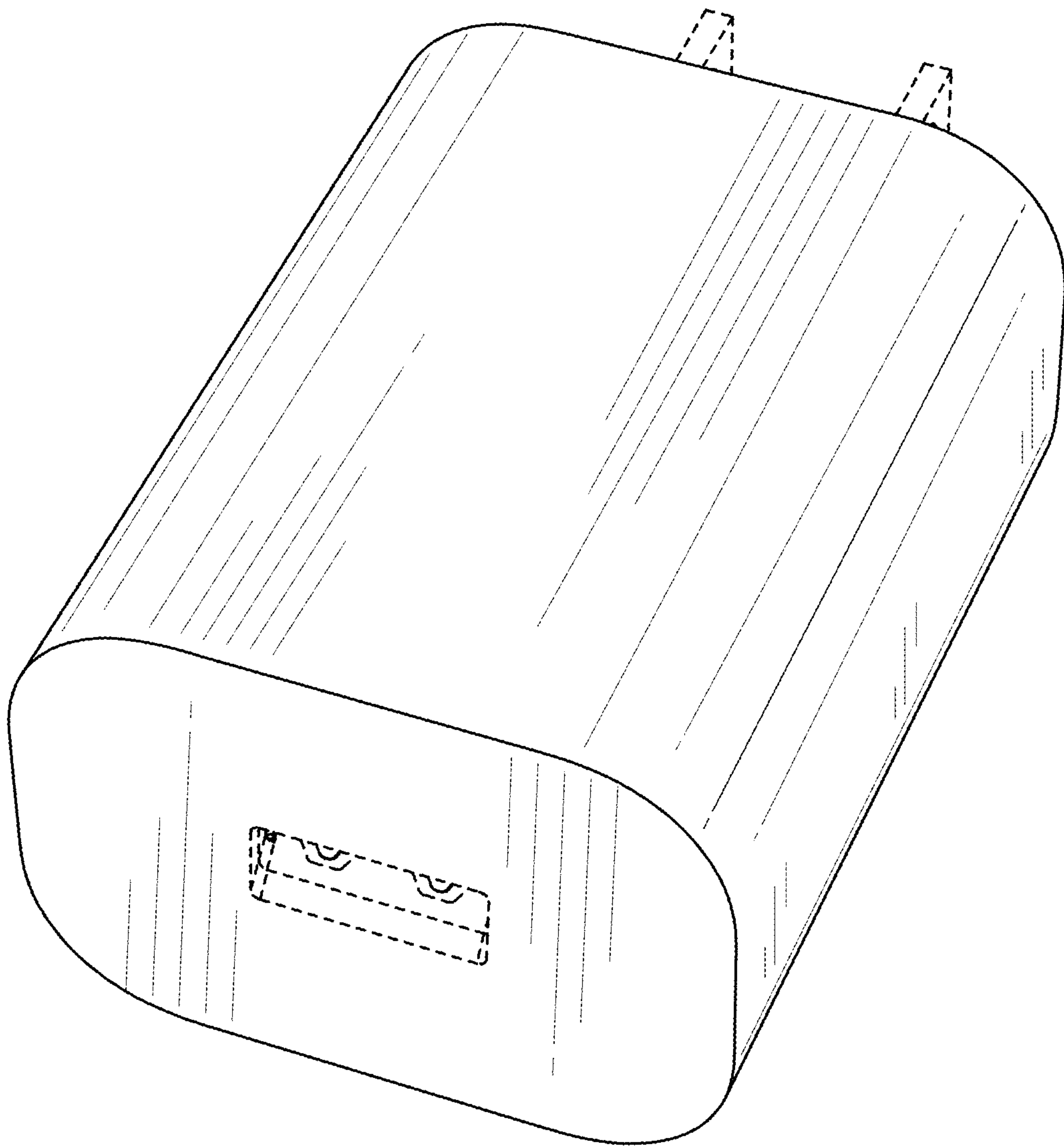

FIG. 17

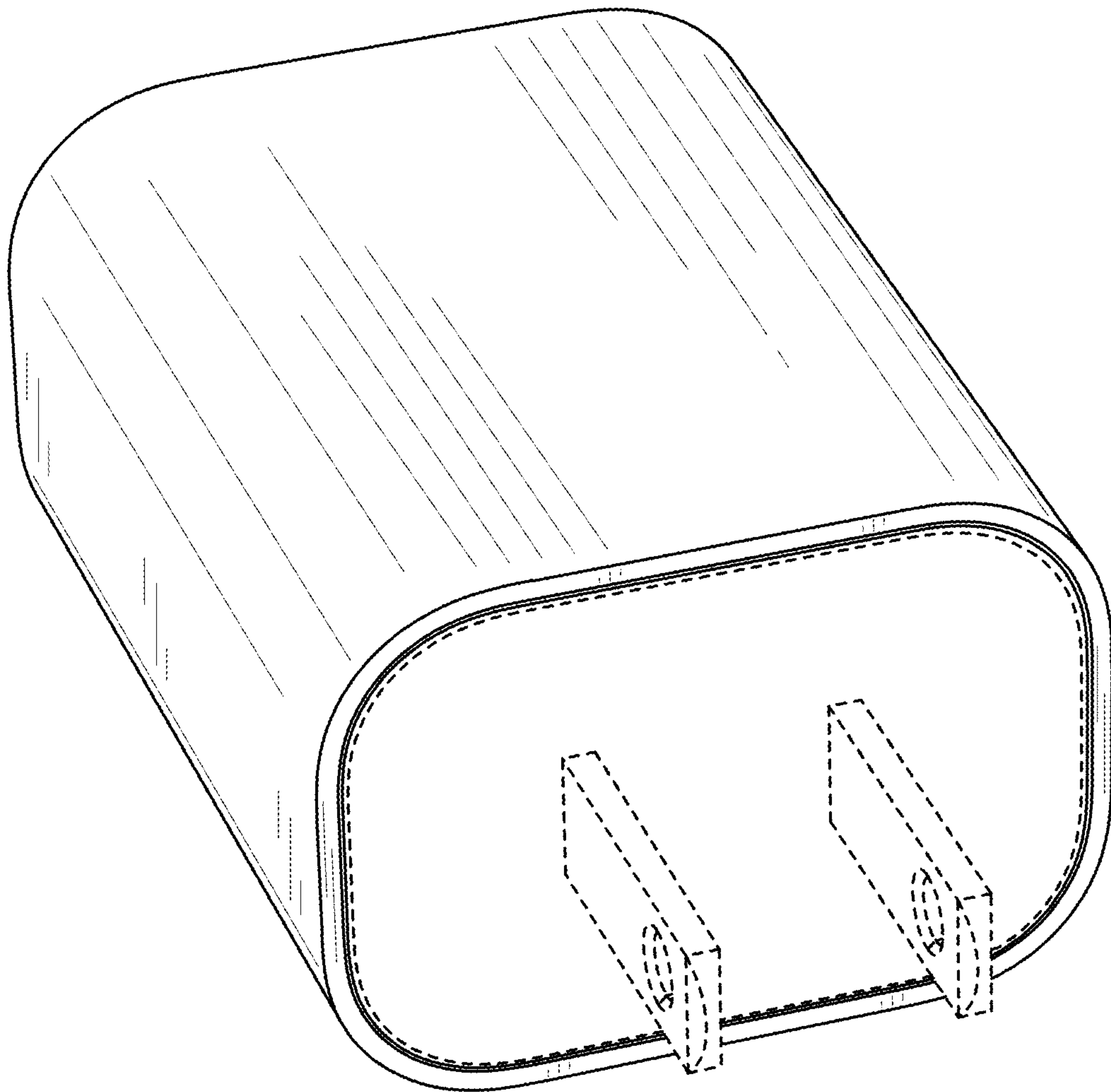

FIG. 18

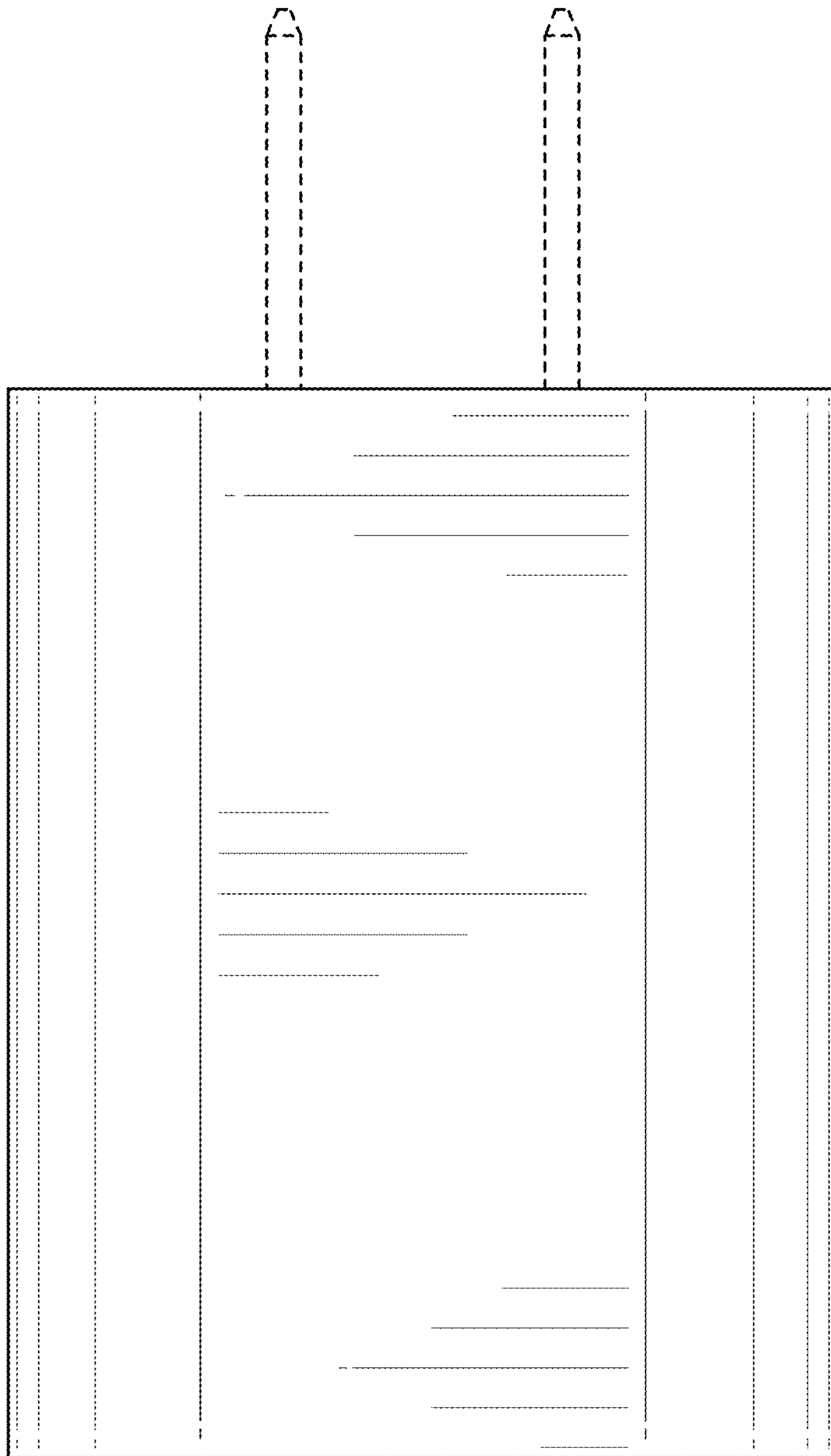

FIG. 19

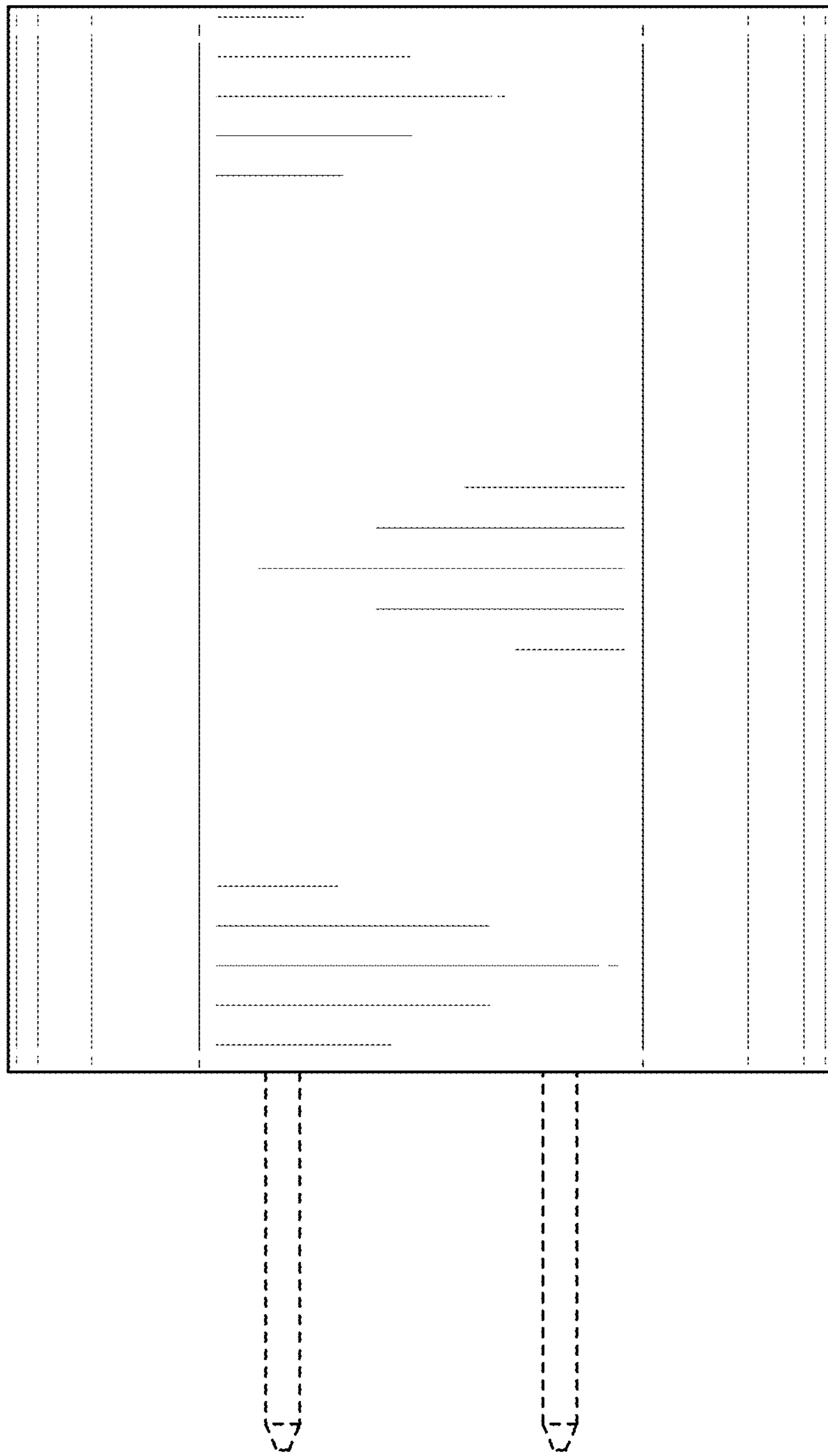

FIG. 20



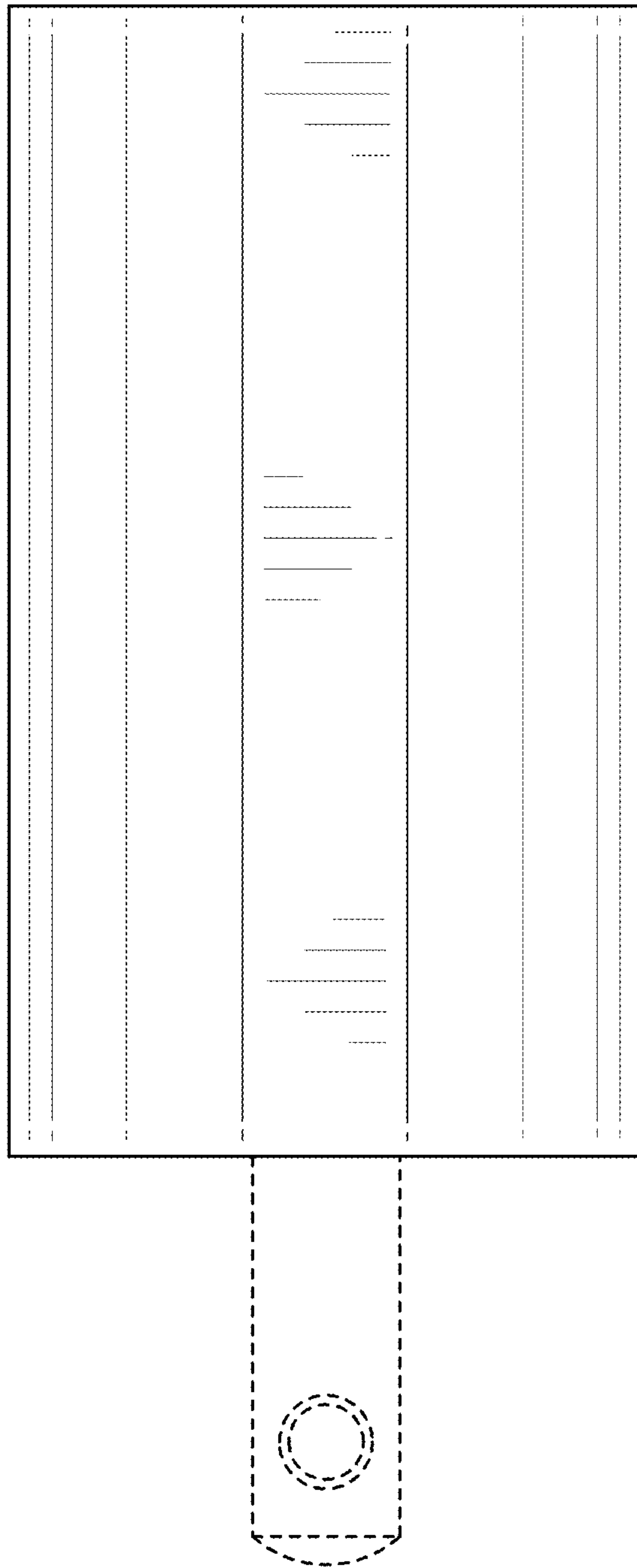

FIG. 21

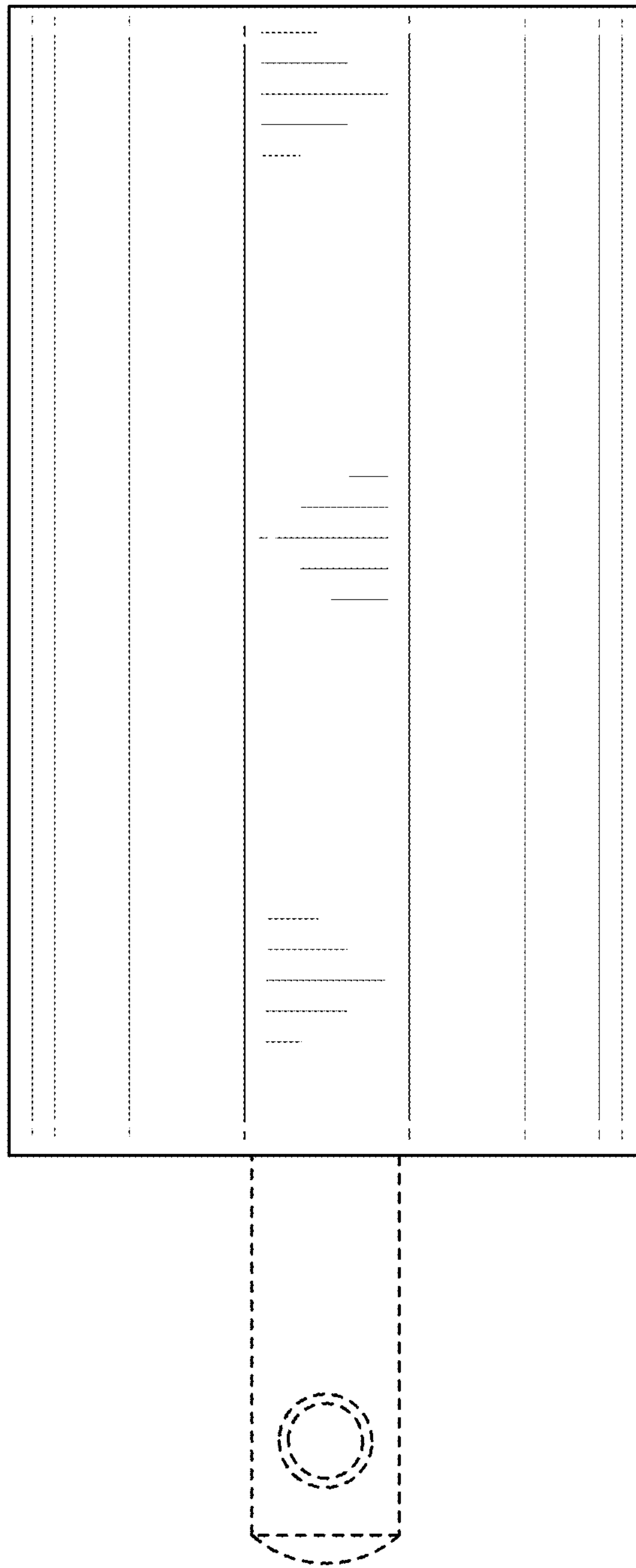

FIG. 22

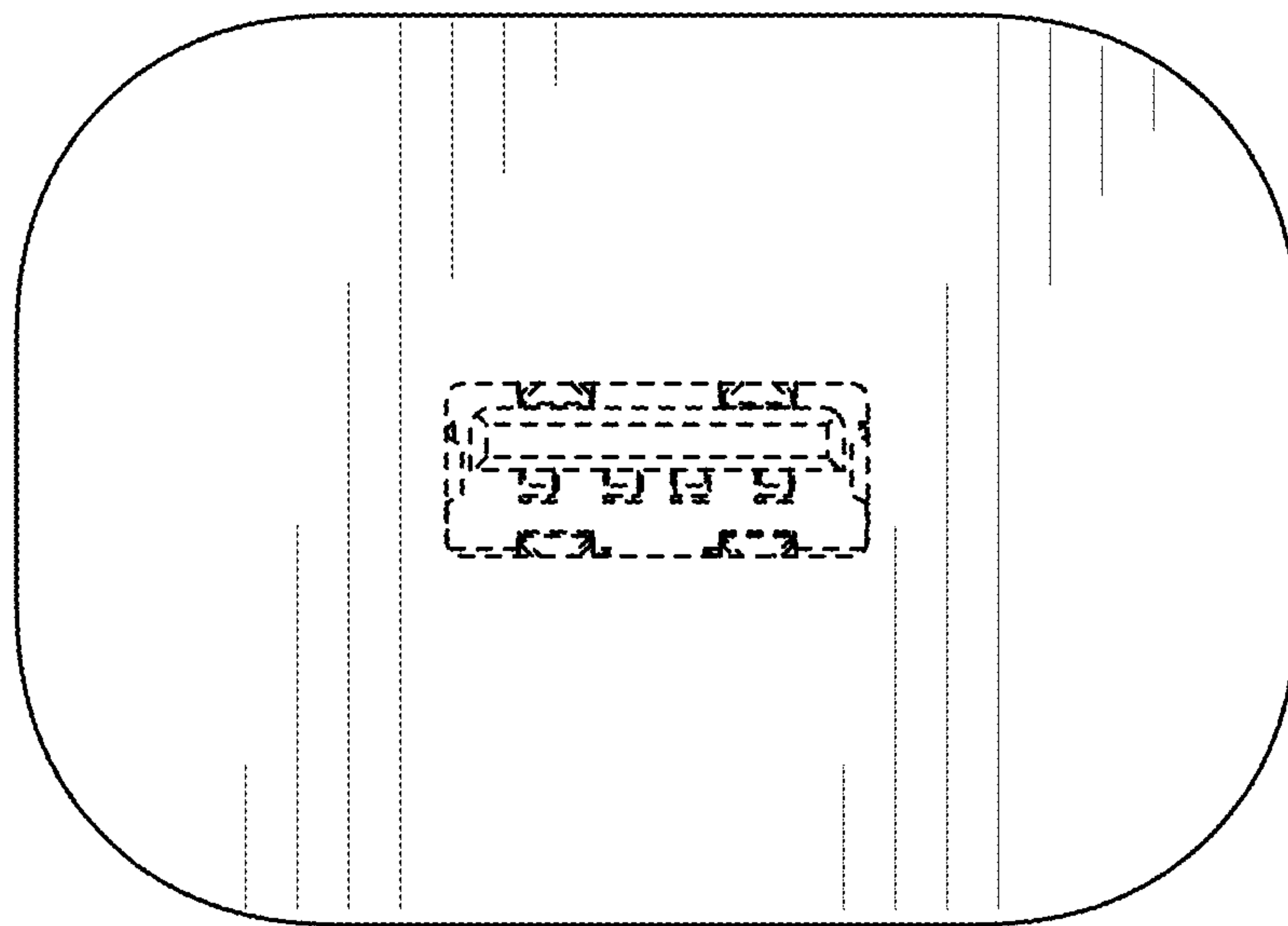

FIG. 23

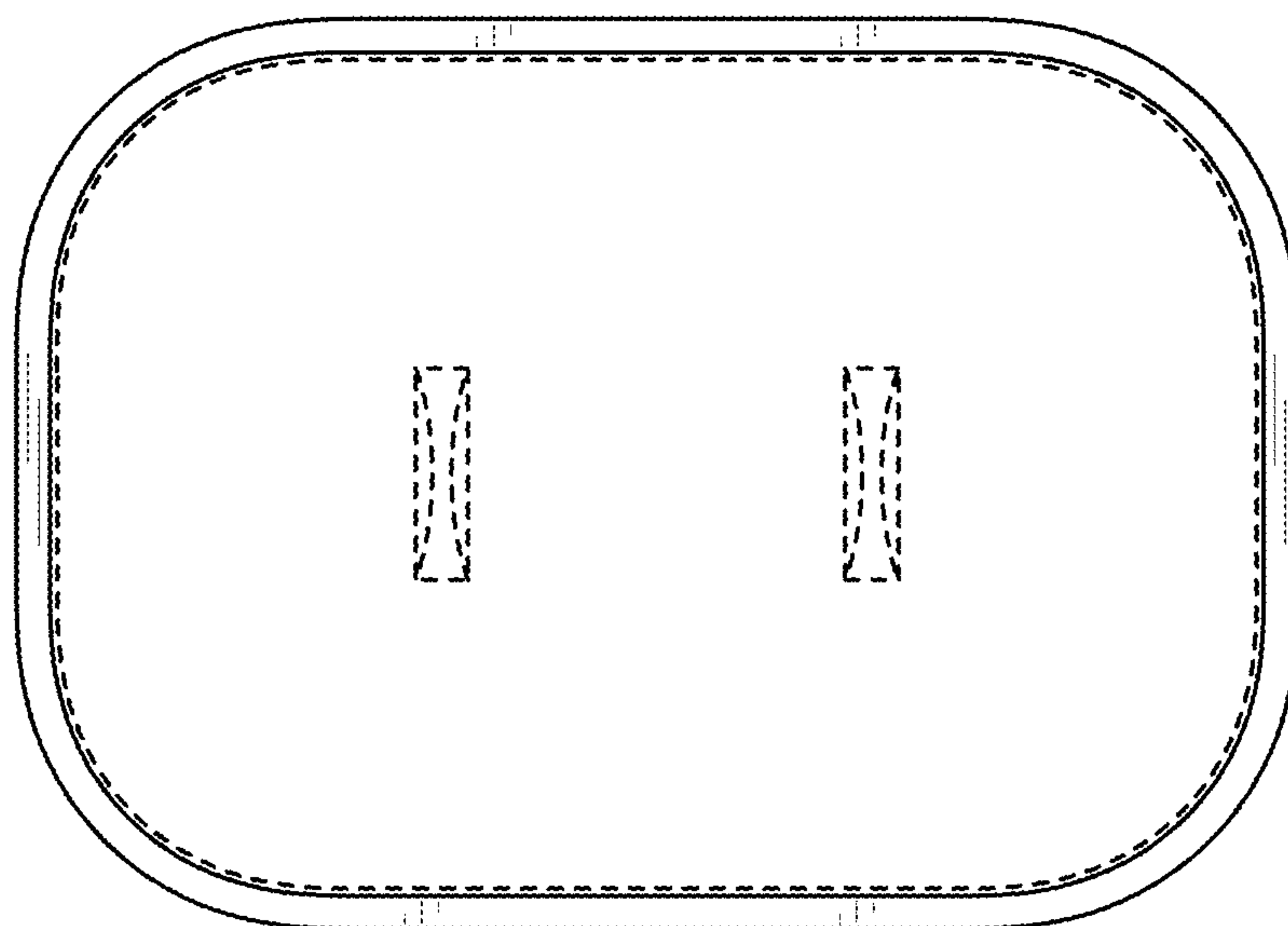

FIG. 24

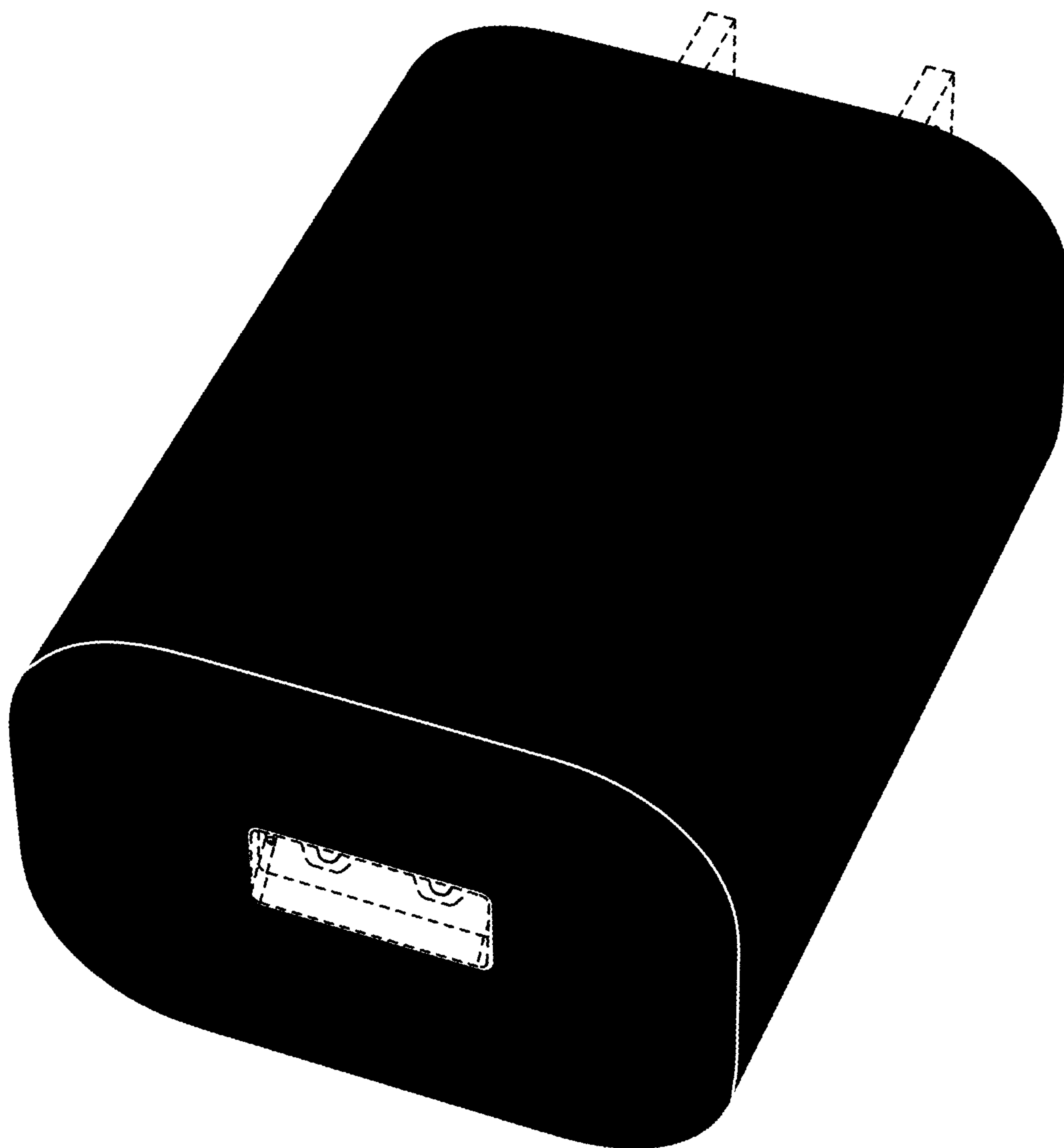

FIG. 25

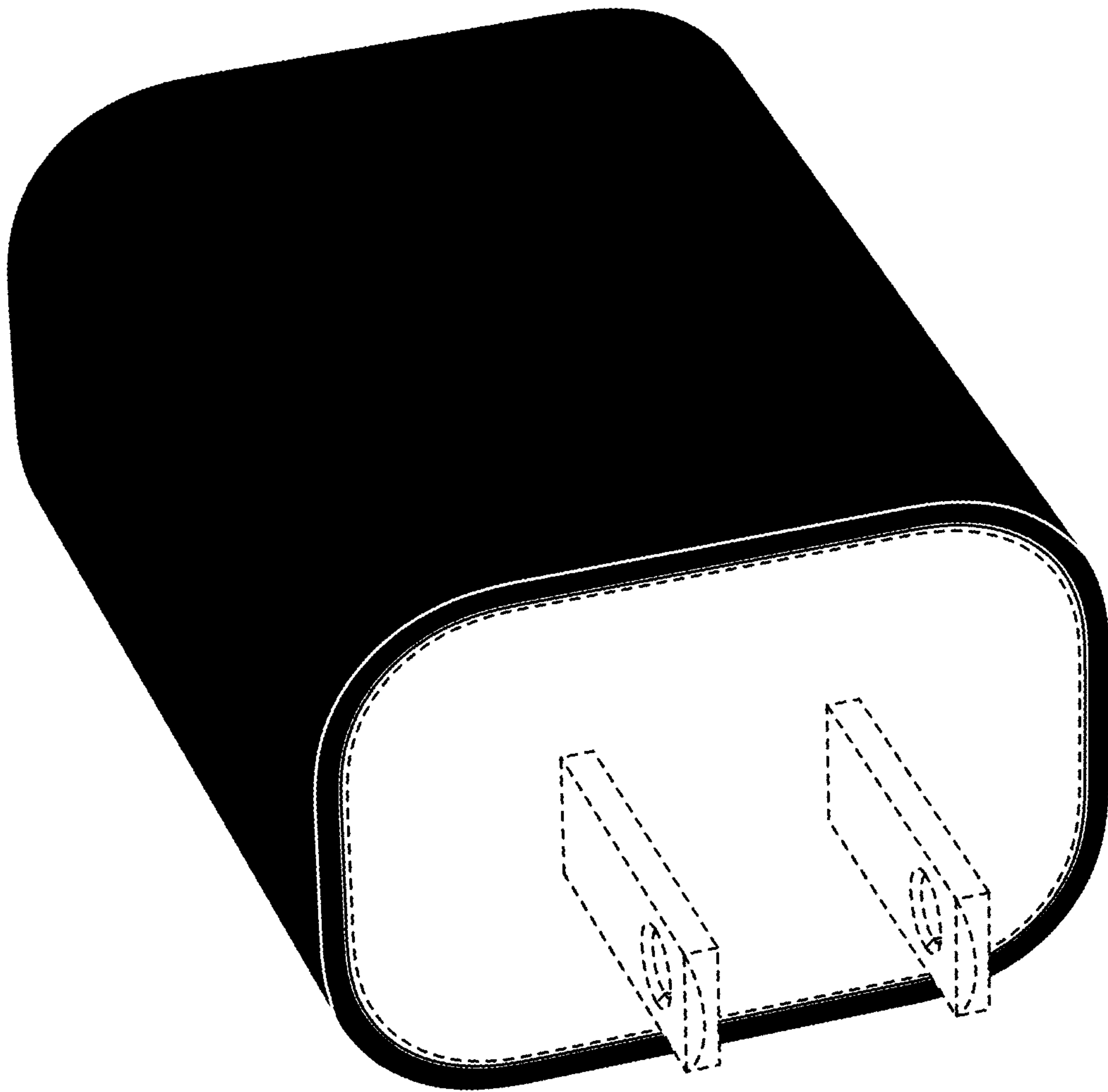

FIG. 26

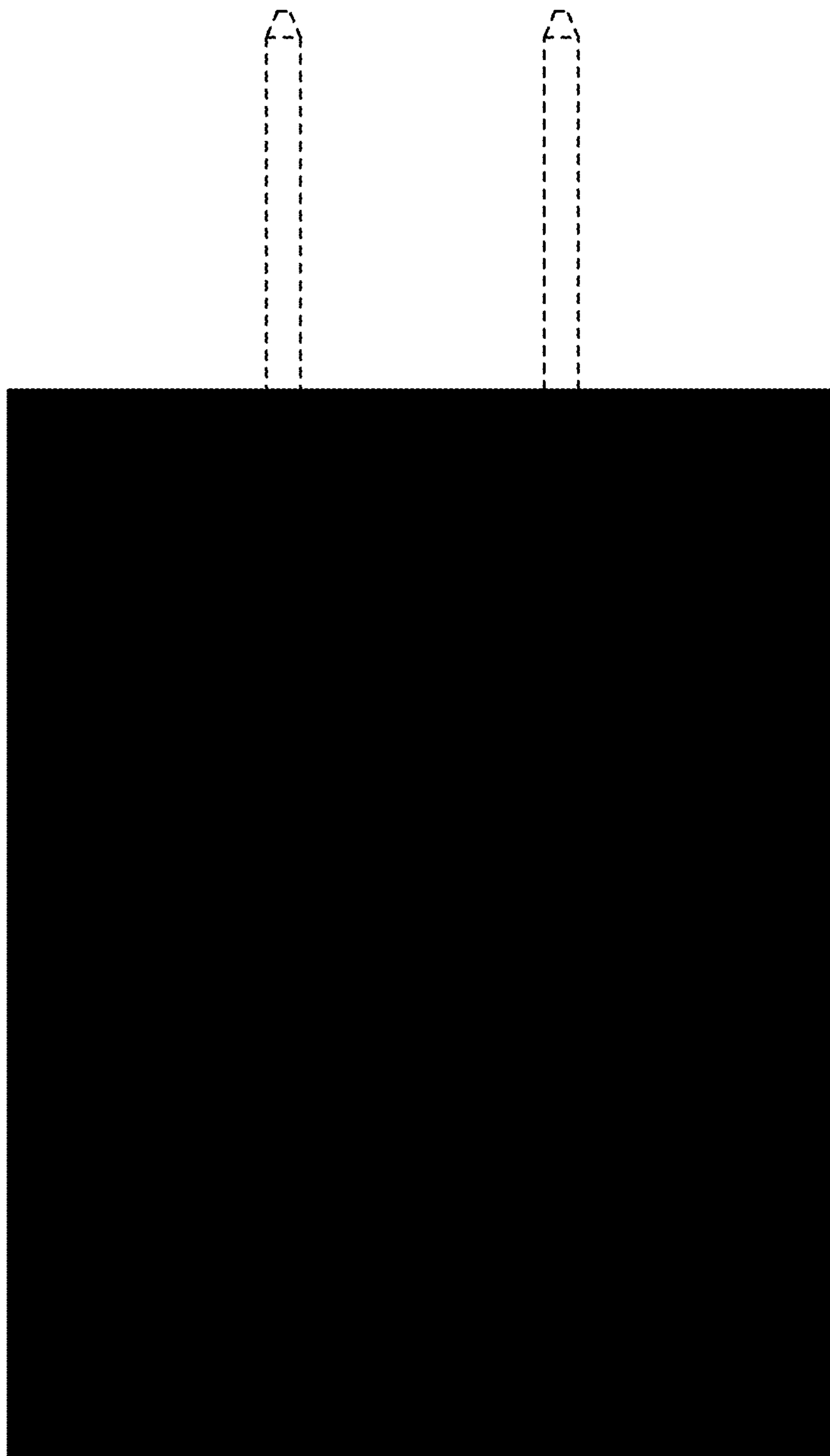

FIG. 27



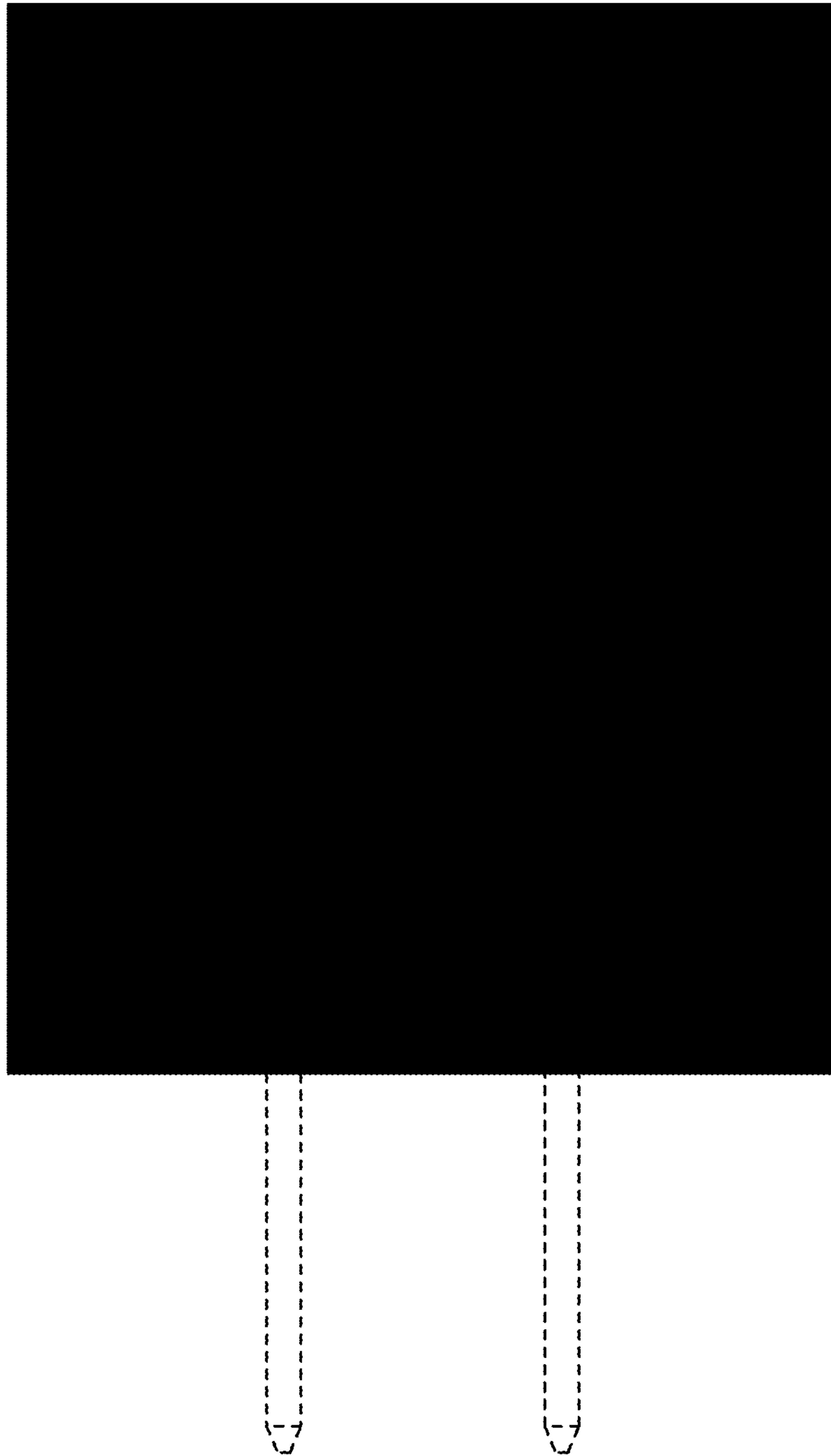

FIG. 28

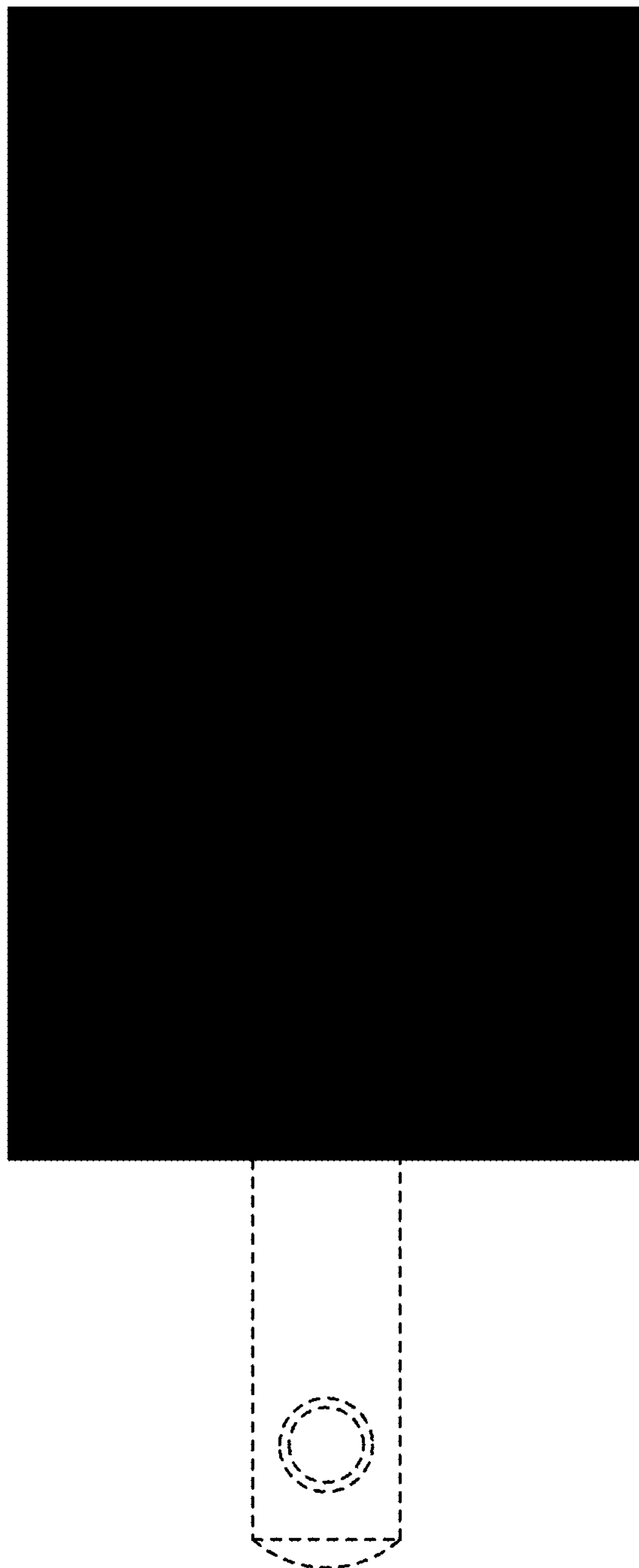

FIG. 29

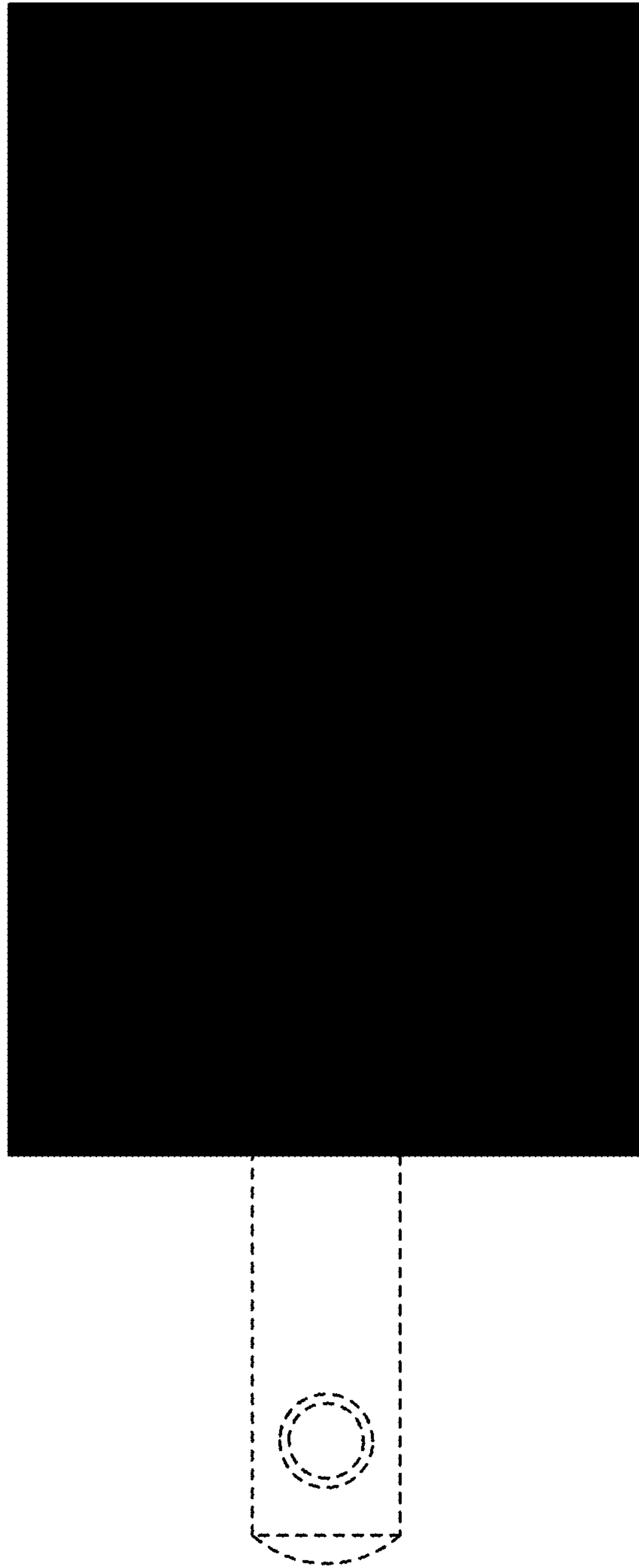

FIG. 30

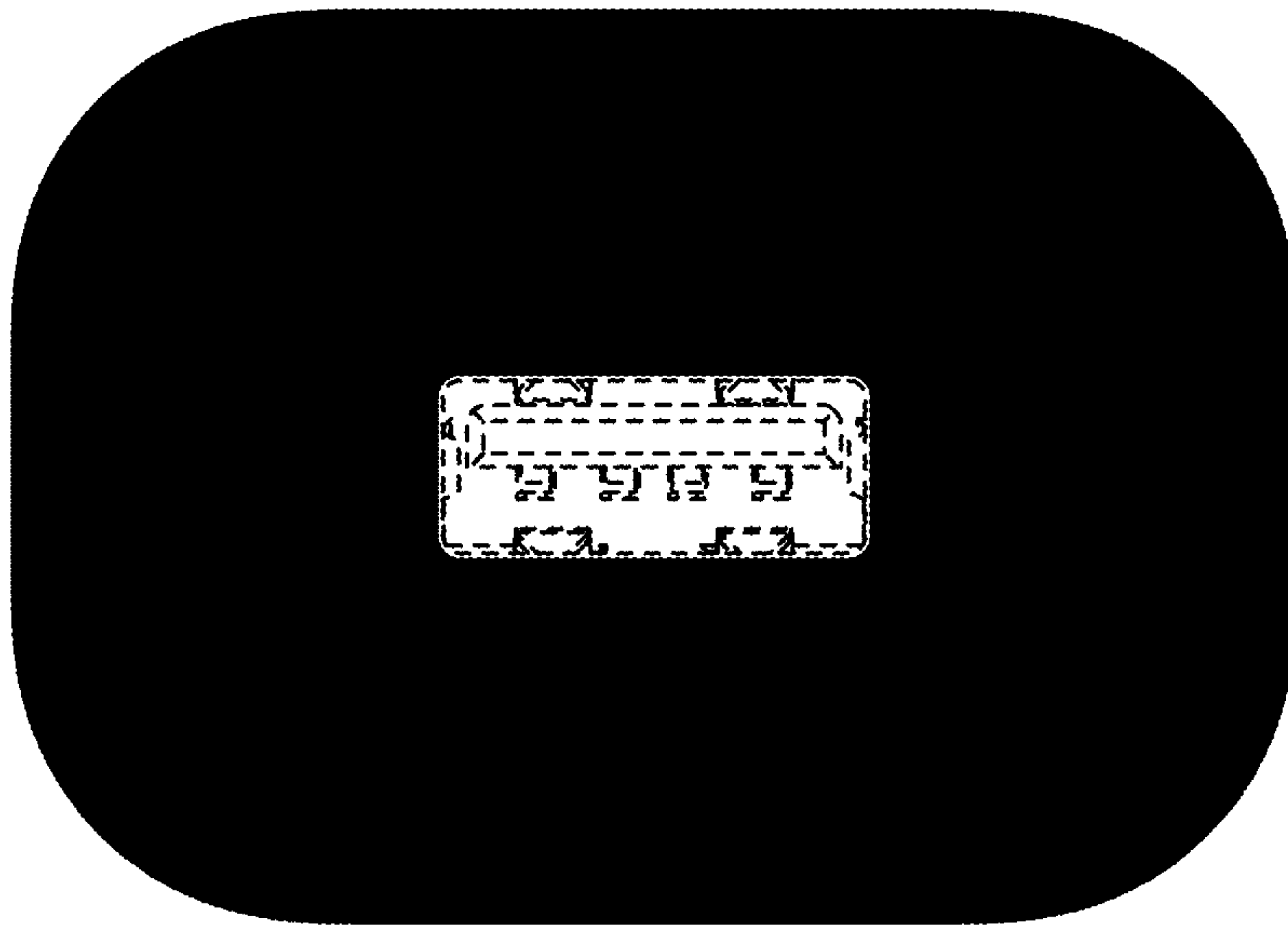

FIG. 31

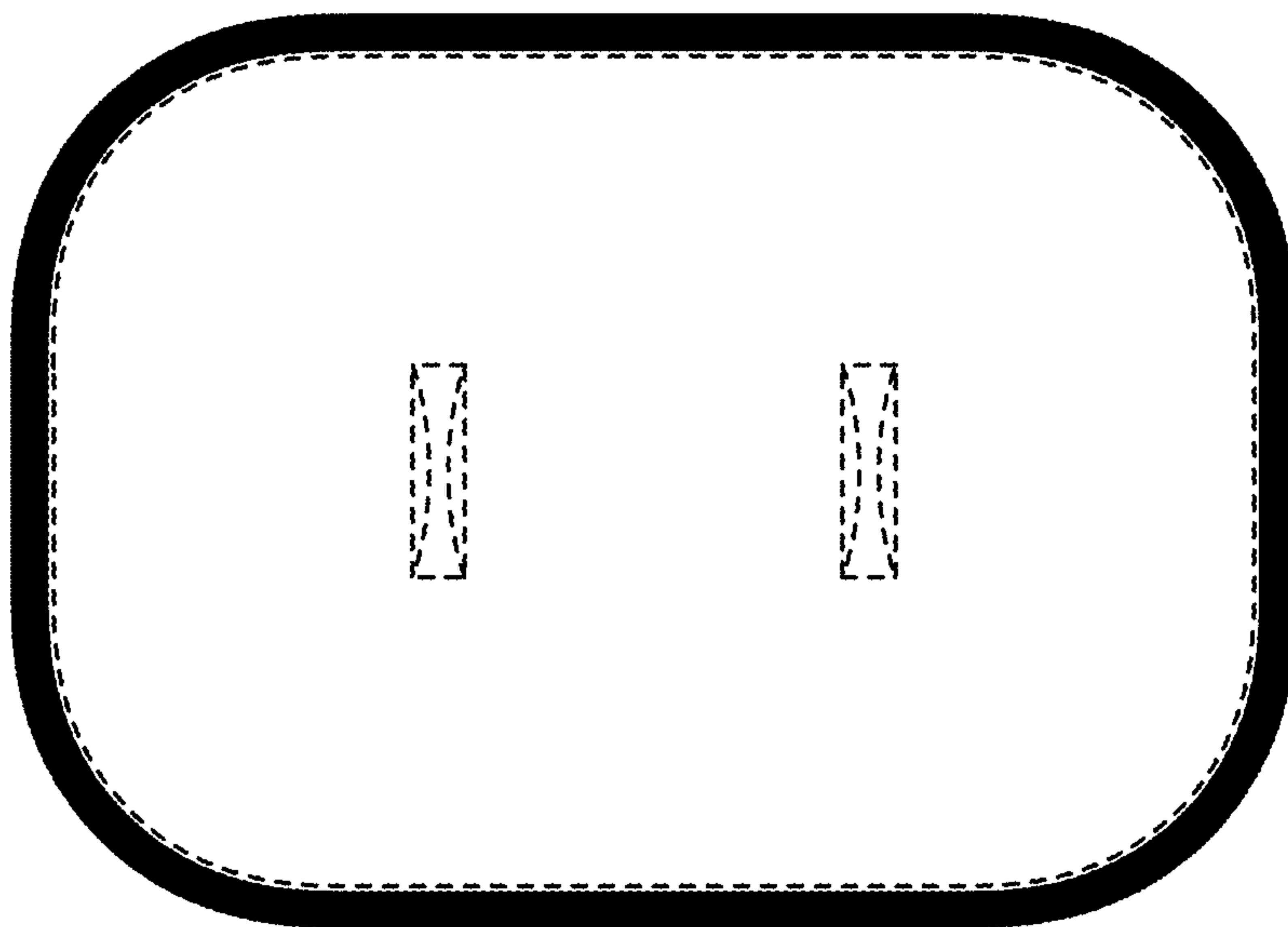

FIG. 32