



US00D892001S

(12) **United States Design Patent** (10) **Patent No.:** **US D892,001 S**
Shao (45) **Date of Patent:** **** Aug. 4, 2020**

(54) **AUTOMOBILE FRONT GRILLE**
(71) Applicant: **MOTI 5, INC.**, Flushing, NY (US)
(72) Inventor: **Liang Shao**, Flushing, NY (US)
(73) Assignee: **Moti 5, Inc.**, Flushing, NY (US)

8,651,554 B1 * 2/2014 Patelczyk B62D 25/12
296/136.08
D713,303 S * 9/2014 Nishio D12/163
D713,308 S * 9/2014 Galante D12/196
D730,786 S 6/2015 Duff et al.
D733,619 S * 7/2015 Glover D12/163
(Continued)

(**) Term: **15 Years**

FOREIGN PATENT DOCUMENTS

(21) Appl. No.: **29/684,354**

CN 303158902 S 10/2014
CN 303367473 S 3/2015

(22) Filed: **Mar. 20, 2019**

(Continued)

(30) **Foreign Application Priority Data**

OTHER PUBLICATIONS

Dec. 19, 2018 (CN) 2018 3 0739402

AM Off-Road. "New Photo." Facebook, published Dec. 17, 2018 (Retrieved from the Internet Aug. 30, 2019). Internet URL: <https://www.facebook.com/AMOffRoad/photos/a.206083853318295/334179440508735/?type=3&theater> (Year: 2018).*

(51) **LOC (12) Cl.** **12-16**

(52) **U.S. Cl.**
USPC **D12/163**

(Continued)

(58) **Field of Classification Search**
USPC D12/86, 90-92, 163, 169, 171, 173, 181,
D12/184, 196, 216, 388
CPC B60R 19/52; B60K 11/08; B62D 25/08;
B62B 9/16

Primary Examiner — Jack Reickel
Assistant Examiner — Rachel A Voorhies
(74) *Attorney, Agent, or Firm* — Rimon PC

See application file for complete search history.

(56) **References Cited**

(57) **CLAIM**

The ornamental design for an automobile front grille, as shown.

U.S. PATENT DOCUMENTS

D324,018 S * 2/1992 Ueno D12/170
D507,214 S * 7/2005 Marchese D12/163
D519,066 S 4/2006 Ney et al.
D521,424 S 5/2006 Sackley
D534,106 S * 12/2006 Matei D12/169
D577,636 S * 9/2008 Saridakis D12/163
D588,964 S 3/2009 Matsuoka et al.
D613,648 S * 4/2010 Wong D12/163
D613,649 S * 4/2010 Wong D12/163
D624,468 S * 9/2010 Wong D12/163
D661,231 S * 6/2012 Galante D12/163
D683,668 S 6/2013 Thurber
D695,159 S * 12/2013 Hildebrand B62D 25/12
D12/163

DESCRIPTION

FIG. 1 is a perspective view of an automobile front grille showing the claimed design;
FIG. 2 is a front view thereof;
FIG. 3 is a back view thereof;
FIG. 4 is a side view thereof;
FIG. 5 is another side view thereof;
FIG. 6 is a top view thereof; and,
FIG. 7 is a bottom view thereof.

1 Claim, 5 Drawing Sheets

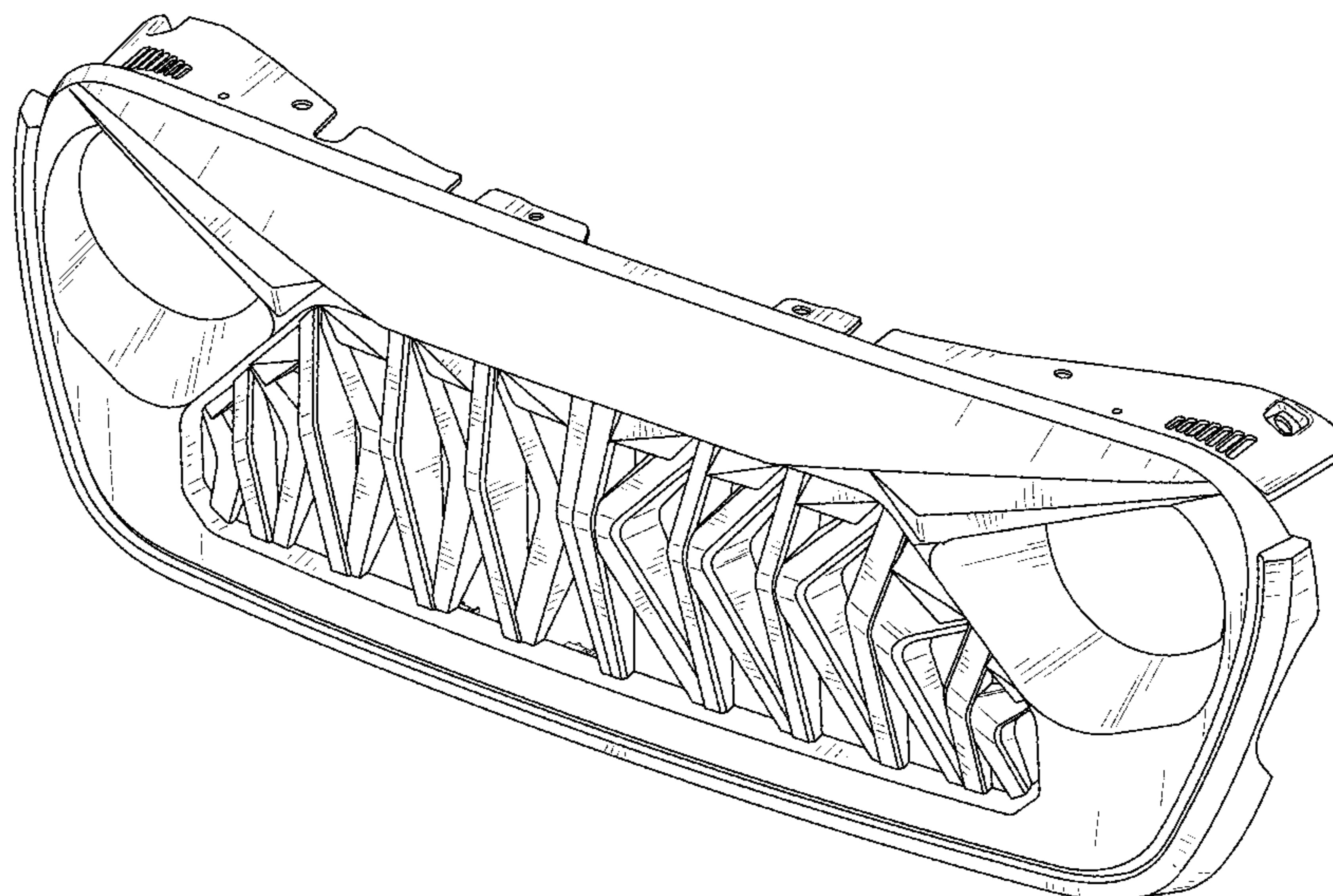

(56)

References Cited

U.S. PATENT DOCUMENTS

D736,123	S	*	8/2015	Hammoud	D12/163
D738,799	S	*	9/2015	Goepfel	D12/169
D746,731	S		1/2016	Quezada		
D749,995	S		2/2016	Azadi et al.		
D775,014	S	*	12/2016	Higgs	D12/170
D777,614	S		1/2017	Wheel		
D790,412	S		6/2017	Dunford et al.		
D794,517	S		8/2017	Woolley		
D800,226	S		10/2017	Zeng		
D815,571	S		4/2018	Zhang		
D819,510	S		6/2018	Zhang		
D826,107	S		8/2018	DiCanzio		
D829,144	S		9/2018	Zeng		
D836,030	S	*	12/2018	Razaghi	D12/92
D840,881	S	*	2/2019	Zhang	D12/163
D842,172	S		3/2019	Chi		
D851,550	S	*	6/2019	Mack	D12/163
D851,551	S	*	6/2019	Mack	D12/163
D851,552	S	*	6/2019	Mack	D12/163
D853,903	S	*	7/2019	Loeb	D12/163
D864,027	S	*	10/2019	Yong	D12/91
D864,028	S	*	10/2019	Yong	D12/91
D864,029	S	*	10/2019	Yong	D12/91
D864,030	S	*	10/2019	Yong	D12/91

FOREIGN PATENT DOCUMENTS

CN	303428541	S	7/2015
CN	303929977	S	2/2016
CN	303911914	S	5/2016
CN	303930216	S	5/2016
CN	303977934	S	7/2016
CN	304004775	S	7/2016
CN	304088133	S	7/2016
CN	304407233	S	6/2017
CN	304407234	S	6/2017
CN	304898373	S	11/2018
CN	305031704	S	2/2019
CN	305249734	S	7/2019
CN	305249735	S	7/2019
DM	67940-005		6/2006
EM	003344746-0001		8/2016
JP	D1477965		7/2013
KR	30-0480989		7/2007

OTHER PUBLICATIONS

AM Off-Road. "Transform your JL with Shark Grille." Facebook, published Dec. 16, 2018 (Retrieved from the Internet Aug. 30, 2019). Internet URL: <<https://www.facebook.com/AMOffRoad/posts/333797123880300>> (Year: 2018).*

Allinoneparts. "Front Shark Grille . . ." Amazon.com, published Mar. 25, 2017 (Retrieved from the Internet Aug. 28, 2019). Internet URL: <https://www.amazon.com/...&pd_rd_wg=jHTrL&pf_rd_p=43281256-7633-49c8-b909-7ffd7d8cb21e&pf_rd_r=QP7V4VY3C0WTH6SJETY0&pvc=1&refRID=QP7V4VY3C0WTH6SJETY0> (Year: 2017).*

Smartkadely, Angry Birds Grille Front Grille for Jeep Wrangler Rubicon Sahara JK Jul. 2017, Front Hood Bumper Mat, accessed

Jan. 1, 2019. <https://www.amazon.fr/Grille-Wrangler-Rubicon-07-2017-Capuche/dp/B075R997BG>.

CJ's Off Road, Rough Country Grille Angry Eyes Jeep Wrangler JK 2007-2018, accessed Jan. 1, 2019. <https://www.cjponyparts.com/rough-country-grille-angry-eyes-jeep-wrangler-jk-2007-2018/p/RC10524/>.

Xprite, Xprite Gladiator Vader Grille Grill with Mesh for 2007-2018 Jeep Rubicon Sahara Sport JK JKU, accessed Jan. 1, 2019. <https://www.amazon.com/Xprite-Wrangler-Gladiator-2007-2018-Rubicon/dp/B07CZ33NP9>.

Xprite, Xprite Gladiator Grille For Titan Offroad—(TJ/LJ 1997-2006), accessed Jan. 1, 2019. <https://www.ieeppeople.com/xprite-gladiator-grille-for-jeep-wrangler-tj-lj-1997-2006/>.

Auxmart Grille Ghost Grill Grid for Jeep Wrangler JK 2007-2017, accessed Jan. 1, 2019. https://www.amazon.com/AUXMART-Grille-Ghost-Wrangler-2007-2016/dp/B01CFKS72K?ref_=Oct_TopRatedC_15736001_4&pf_rd_p=48b47916-a8c6-5d31-888b-d09262140194&pf_rd_s=merchandise-search-6&pf_rd_t=101&pf_rd_i=15736001&pf_rd_m=ATVPDKIKX0DER&pf_rd_r=EXMBVB0PRHGZMR.

Deegan, Deegan 38 Grille w/ 10 in. LED Light Bar, accessed Jan. 1, 2019. <https://www.extremeterrain.com/deegan-38-grille-w-10-led-light-bar-0717-jk.html#>.

Cliffride, Holcomb Grille w/ 22 in. LED Light Bar (07-18 Jeep Wrangler JK), accessed Jan. 1, 2019. <https://www.extremeterrain.com/cliffride-holcomb-grille-22in-led-lightbar-0717.html>.

V-SEK, Gladiator Angry Skull Front Matte Black Grille Grid Grill for Jeep Wrangler Rubicon Sahara Sport JK JKU 2007-2017, accessed Jan. 1, 2019. <https://www.amazon.com/V-SEK-Gladiator-Wrangler-Rubicon-2007-2017/dp/B07FZYB3R1>.

Rugged Ridge, LED Mesh Grille Insert, Jun. 2016 Monthly Update, accessed Jan. 1, 2019. <http://www.ruggedridge.com/blog/tag/grille/>.

Barricade, Matte Black Grille Cover (07-18 Jeep Wrangler JK), accessed Jan. 1, 2019. <https://www.extremeterrain.com/barricade-grille-cover-jk-j100721.html>.

Xprite, New Generation G2 Matte Black Angry Bird Grille Grid Grill Overlay for 1997-2006 Jeep Wrangler TJ LJ, accessed Jan. 1, 2019. <https://www.amazon.com/Xprite-Grille-Wrangler-Rubicon-2007-2018/dp/B01ETX4QOY>.

Car Club, Matte Black Angry Bird Grille Cover Front Grill Guard Fits Jeep Wrangler TJ 97-06, accessed Jan. 1, 2019. <https://www.ebay.com/itm/183593106559>.

Iturning, 7PC Grille Inserts, Matte Black Grill Guards Mesh for Jeep Wrangler TJ 97-06, accessed Jan. 1, 2019. <https://www.ebay.com/itm/372465278528>.

Xprite, New Generation G2 Matte Black Angry Bird Grille Grill for 97-06 Jeep Wrangler TJ, accessed Jan. 1, 2019. <https://www.ebay.com/itm/292897553841>.

Walmart, Durable decorative grille vehicle modified parts, available at: <https://www.walmart.com/ip/Upgrade-Upgrade-Grilles-For-Jeep-Vehicle-Front-Grill-For-Jeep-Wrangler-2007-2017-Durable-Decorative-Grille-Vehicle-Modified-Parts/563021602>; accessed Aug. 23, 2019.

Hidled, Angry bird style front grill auto replaceable front grille for jeep wrangler, Item Code: HL-86, available at: http://www.hidled.com/angry-bird-style-front-grille-auto-replaceable-front-grille-for-jeep-wrangler_p0086.html; accessed Aug. 23, 2019.

Aliexpress, Car front grill grille mesh insert for jeep wrangler sports sahara freedom rubicon etc 2007-2017 automobile accessories black, available at <https://www.aliexpress.com/item/32951737198.html>; accessed Aug. 23, 2019.

* cited by examiner

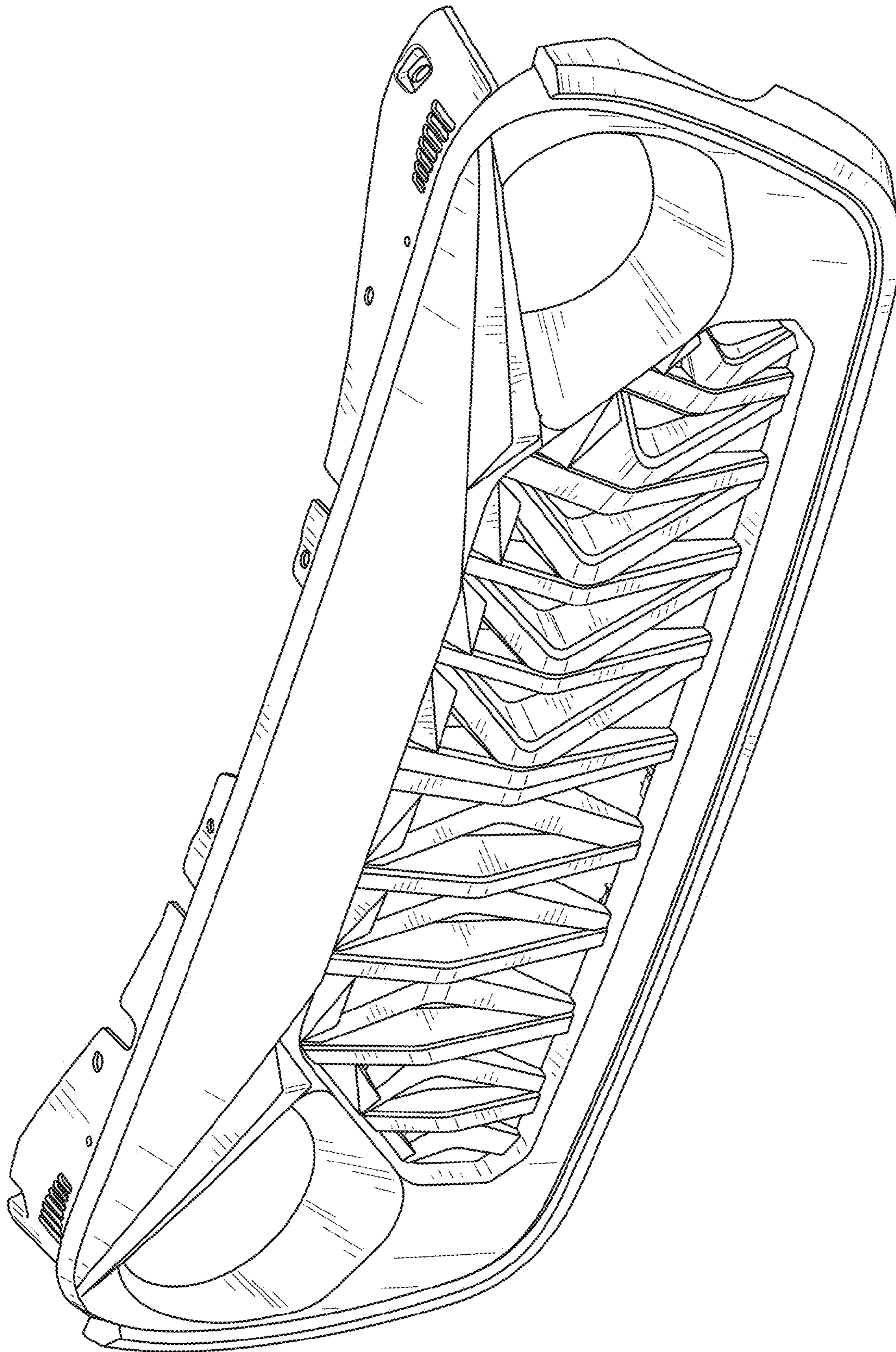

FIG. 1

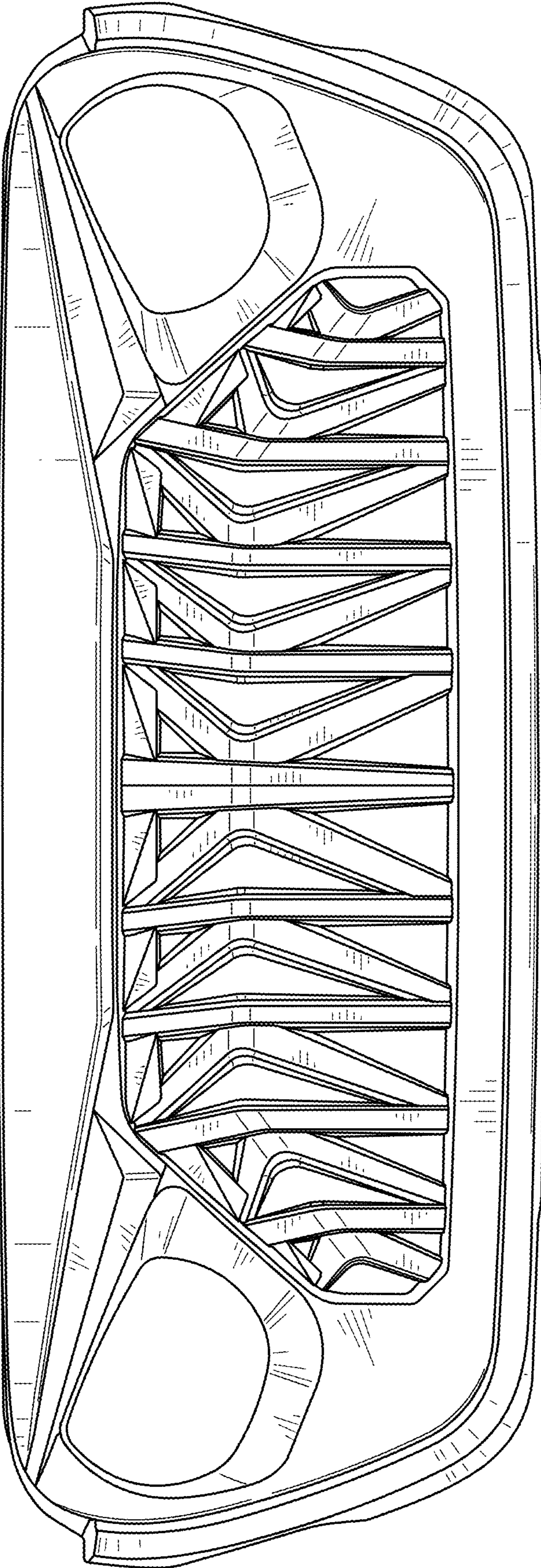

FIG. 2

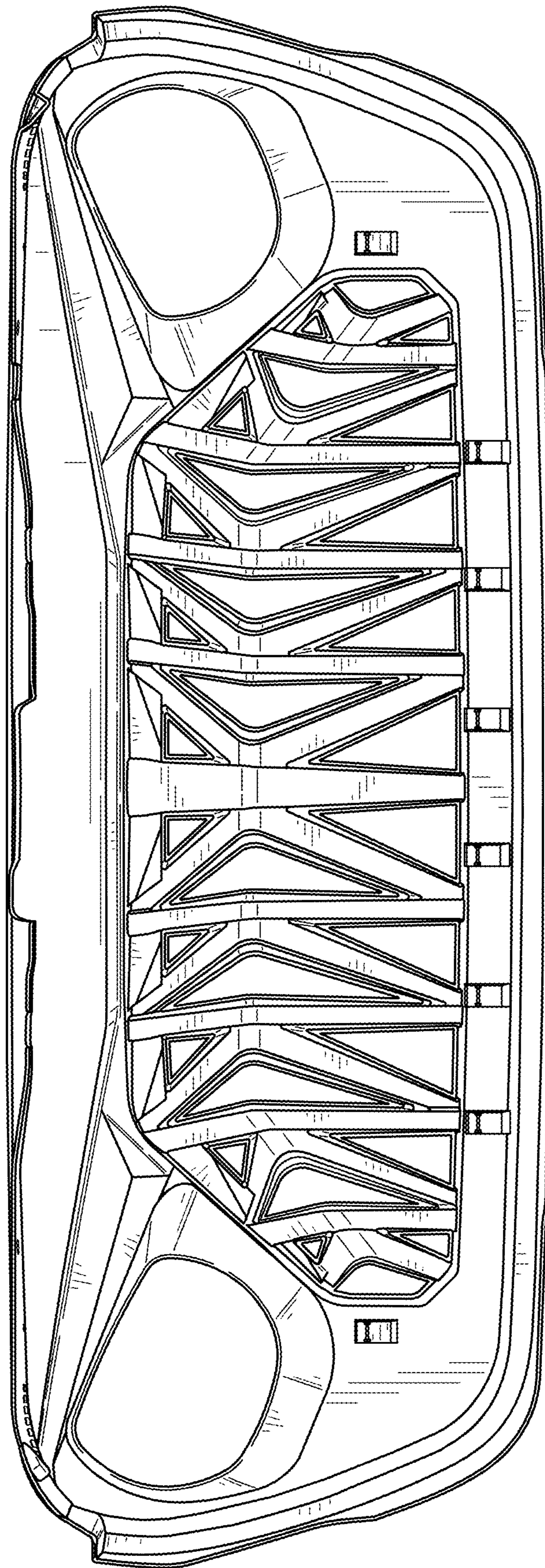

FIG. 3

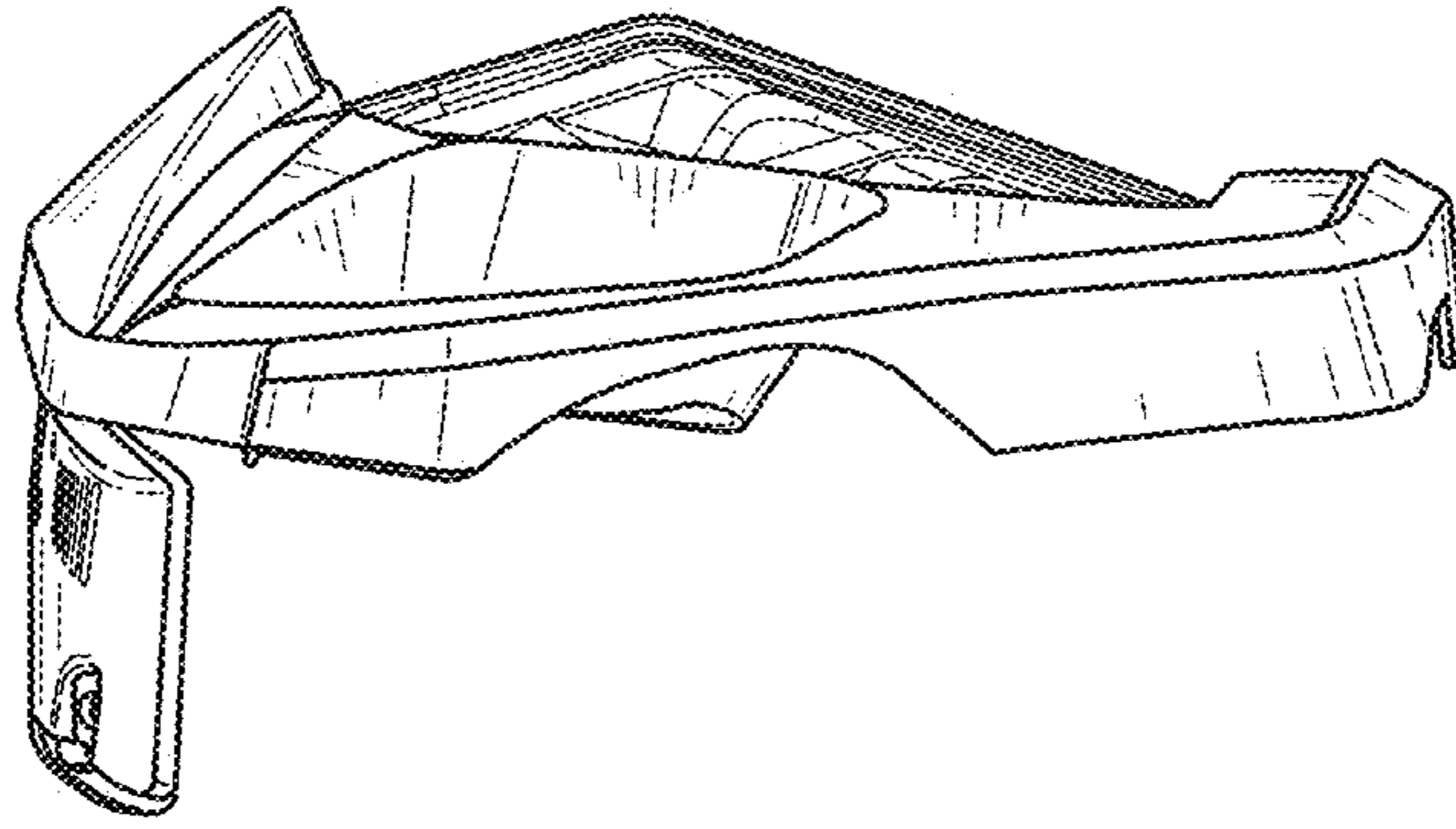

FIG. 5

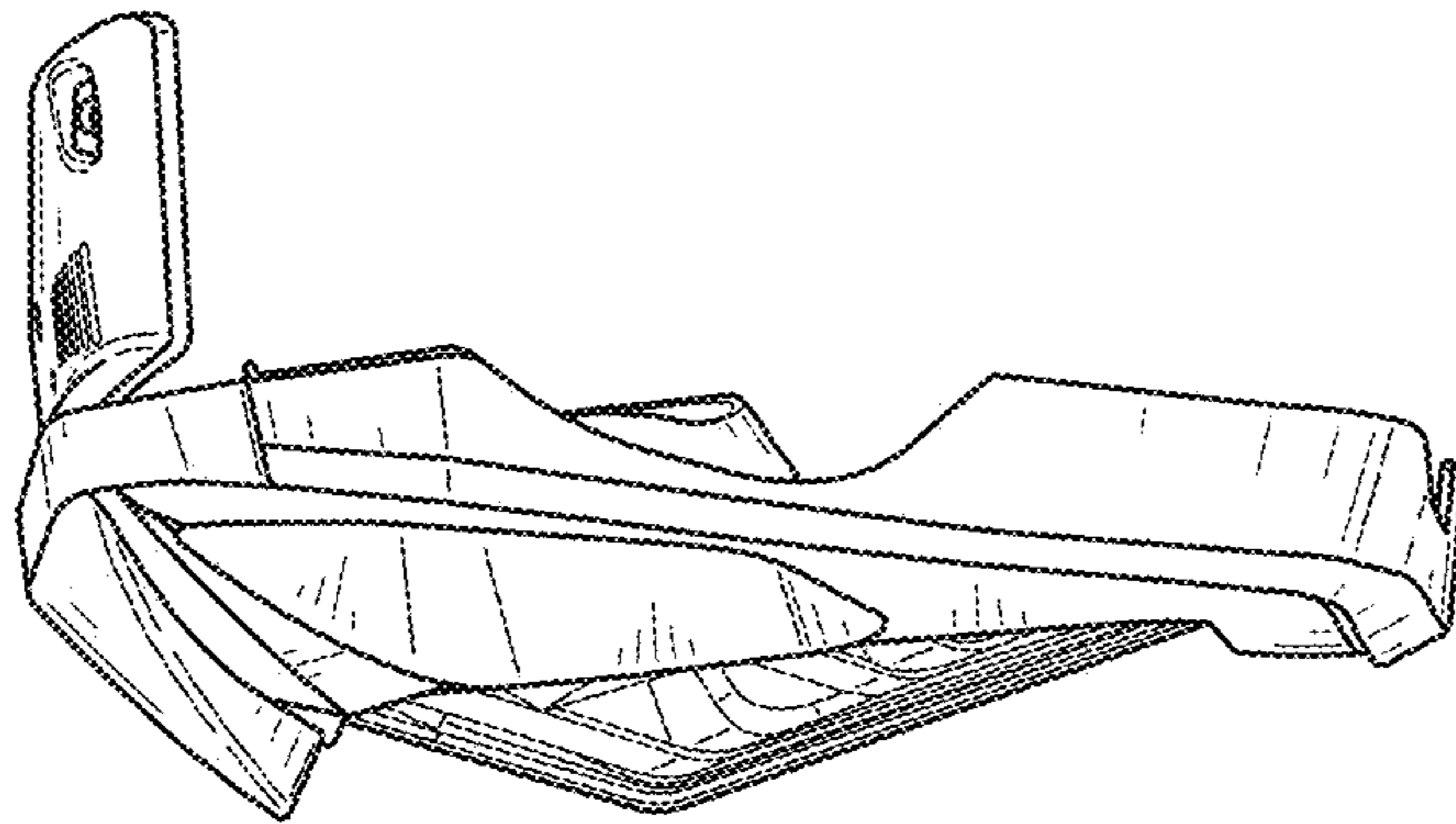

FIG. 4

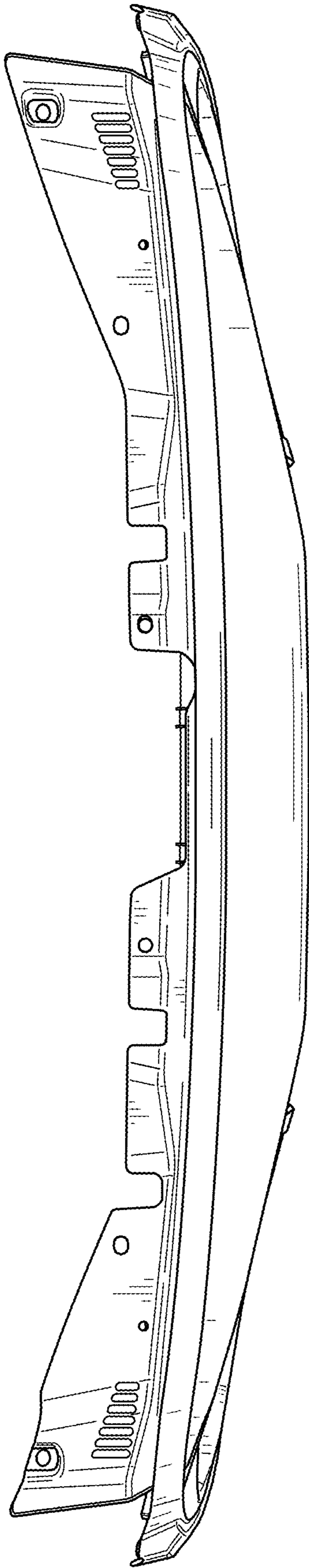

FIG. 6

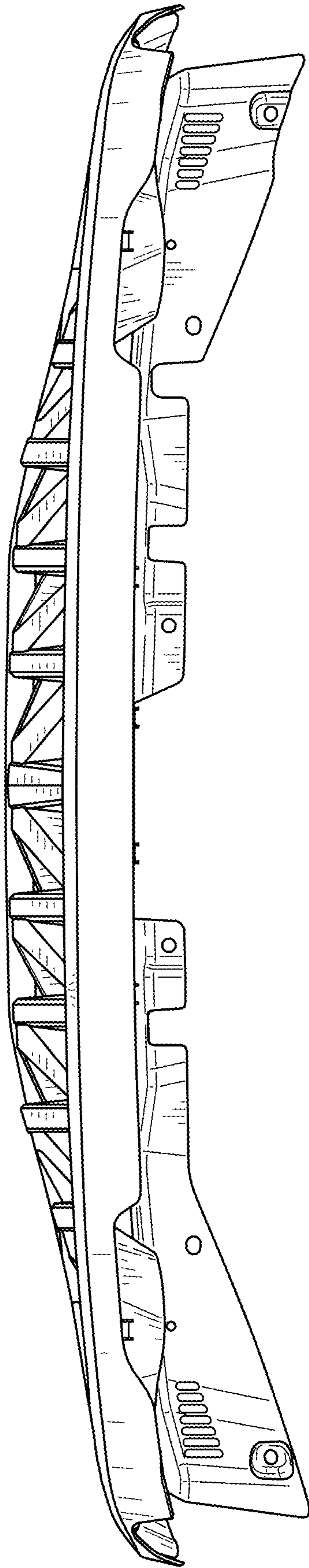

FIG. 7