



US00D891948S

(12) **United States Design Patent**
Chen

(10) **Patent No.:** **US D891,948 S**

(45) **Date of Patent:** **** Aug. 4, 2020**

(54) **MEDICAL INFRARED THERMOMETER**

D842,137 S * 3/2019 Wang D10/57
D843,243 S * 3/2019 Wang D10/57
D873,157 S * 1/2020 Gao D10/57

(71) Applicant: **Shenzhen Pacom Medical Instruments Co., Ltd.**, Shenzhen (CN)

* cited by examiner

(72) Inventor: **Xuewen Chen**, Shenzhen (CN)

Primary Examiner — Antoine Duval Davis

(**) Term: **15 Years**

(74) *Attorney, Agent, or Firm* — ZANIP

(21) Appl. No.: **29/678,575**

(22) Filed: **Jan. 30, 2019**

(57) **CLAIM**

(51) **LOC (12) Cl.** **10-04**

The ornamental design for a medical infrared thermometer, as shown and described.

(52) **U.S. Cl.**

USPC **D10/57**

(58) **Field of Classification Search**

USPC D10/57

CPC G01J 5/04; G01J 5/041; G01J 5/042; G01J 5/043; G01J 5/044; G01J 5/045; G01J 5/046; G01J 5/047; G01J 5/048; G01J 5/049; G01J 5/0265; G01K 1/02; G01K 1/022; G01K 1/024; G01K 1/08; G01K 1/083; G01K 1/086; G01K 3/00-3/14; G01K 2003/145; G01K 13/002; G01K 13/004; G01K 2219/00; G01K 5/04-5/225; G01K 5/22; G01K 221/00

See application file for complete search history.

DESCRIPTION

FIG. 1 is a first perspective view of a medical infrared thermometer showing my design;
FIG. 2 is a second perspective view thereof;
FIG. 3 is a front view thereof;
FIG. 4 is a back view thereof;
FIG. 5 is a left side view thereof;
FIG. 6 is a right side view thereof;
FIG. 7 is a top plan view thereof; and,
FIG. 8 is a bottom plan view thereof.

The dashed or broken lines shown in the drawings depict portions of the medical infrared thermometer in which the design is embodied that form no part of the claimed design.

(56) **References Cited**

U.S. PATENT DOCUMENTS

D693,247 S * 11/2013 Juhng D10/57
D805,927 S * 12/2017 Verbrugge D10/57

1 Claim, 8 Drawing Sheets

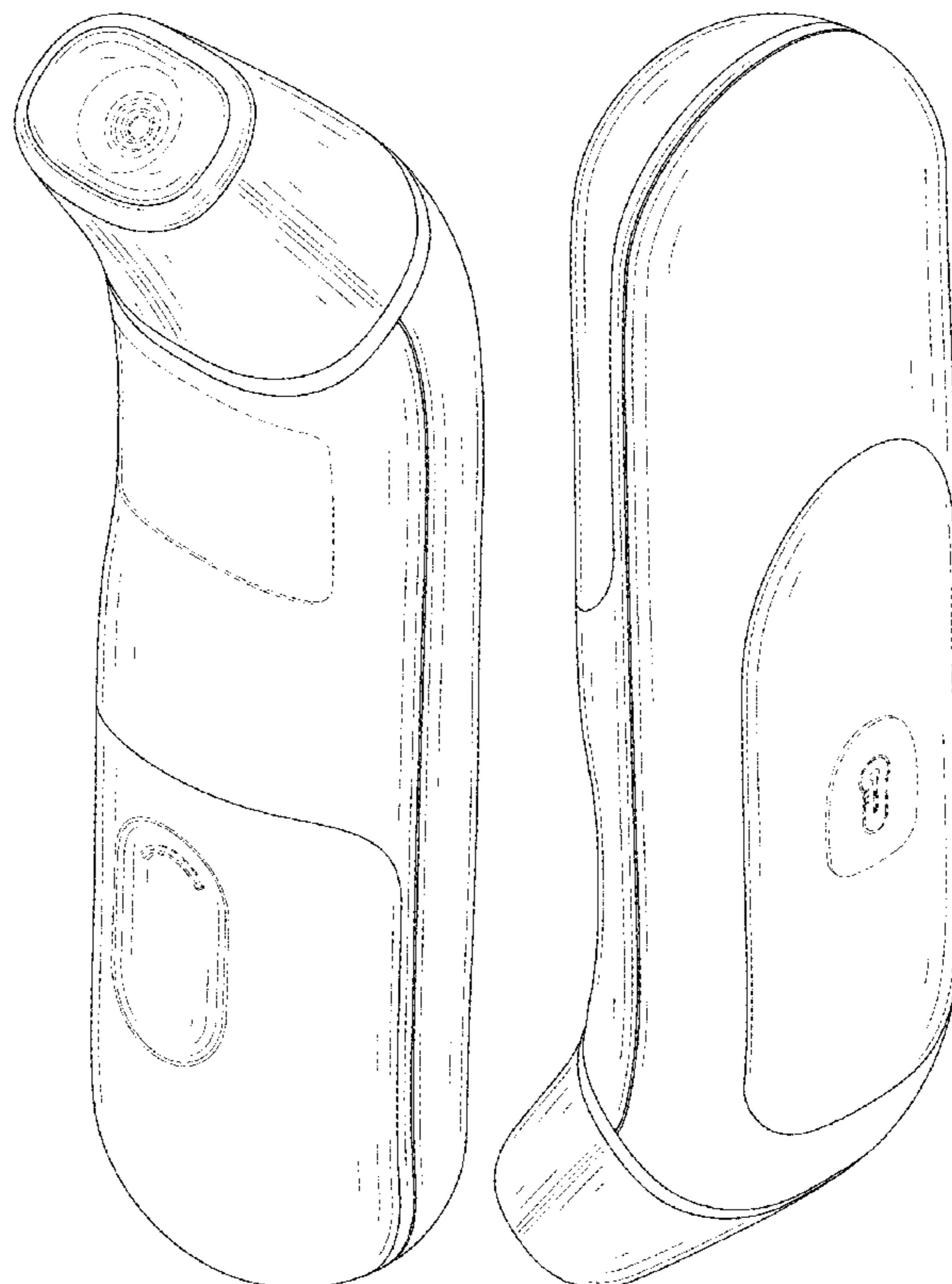

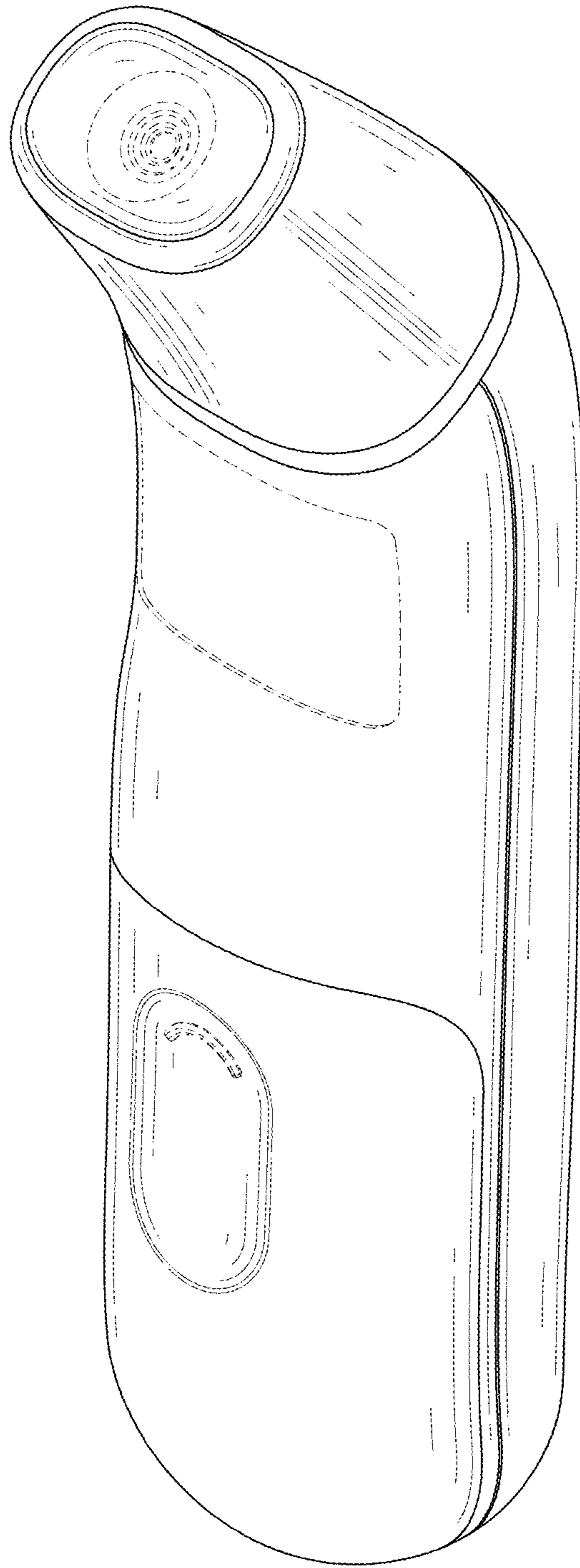

FIG. 1

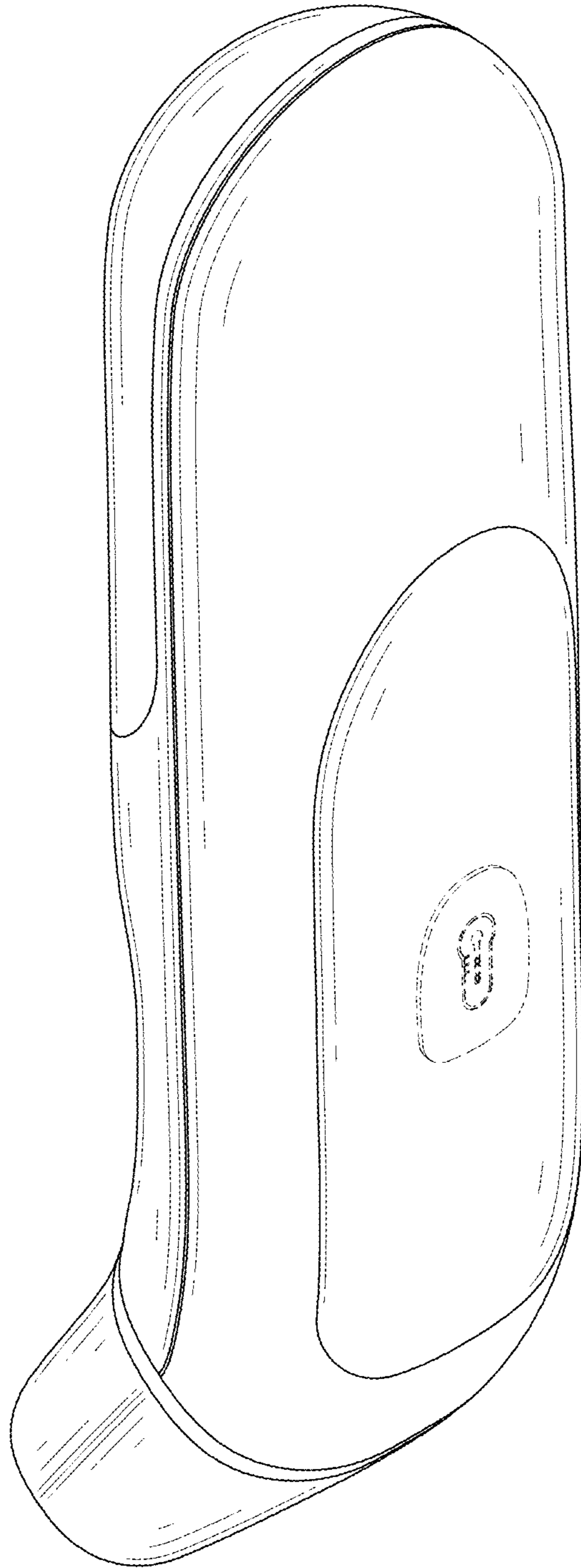

FIG. 2

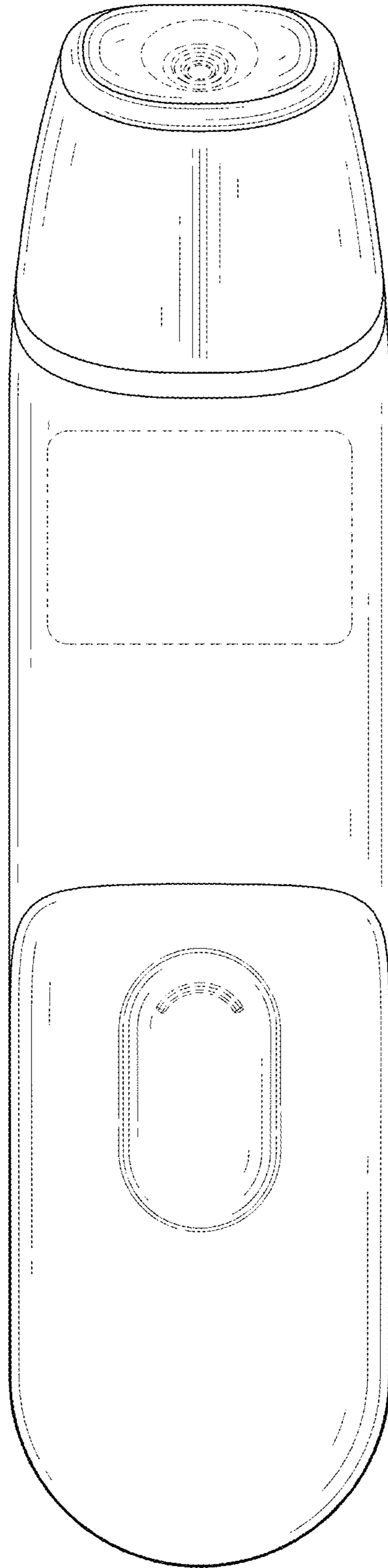

FIG. 3

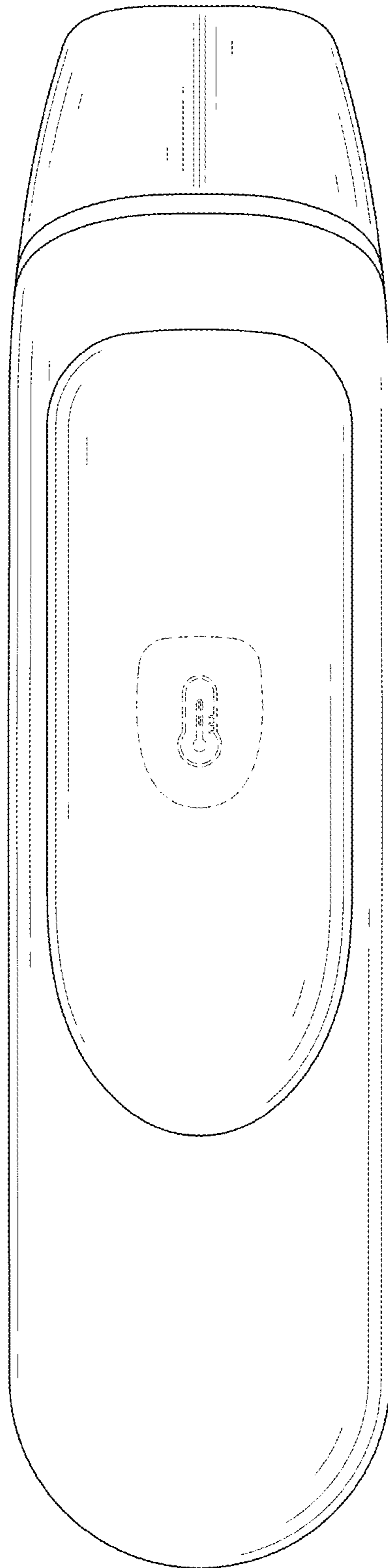

FIG. 4

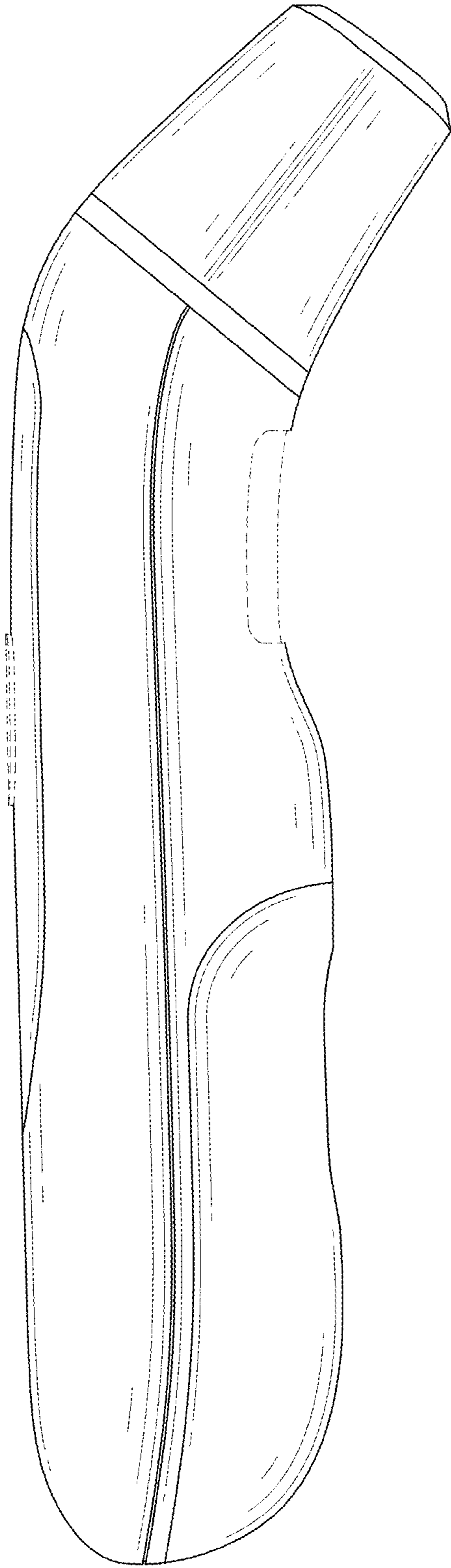

FIG. 5

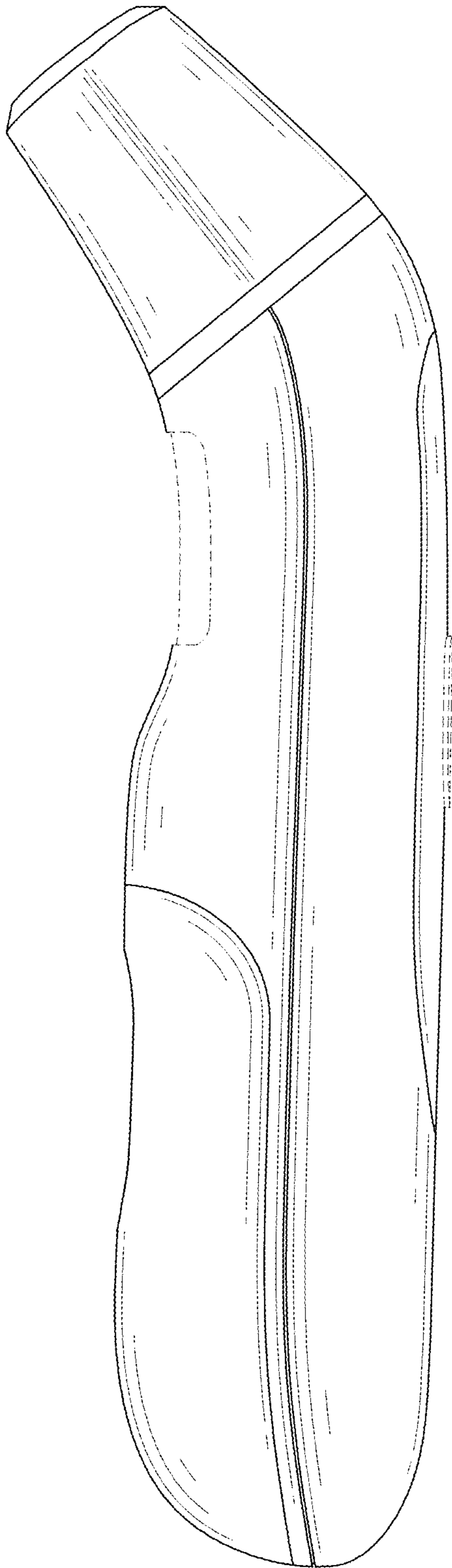

FIG. 6

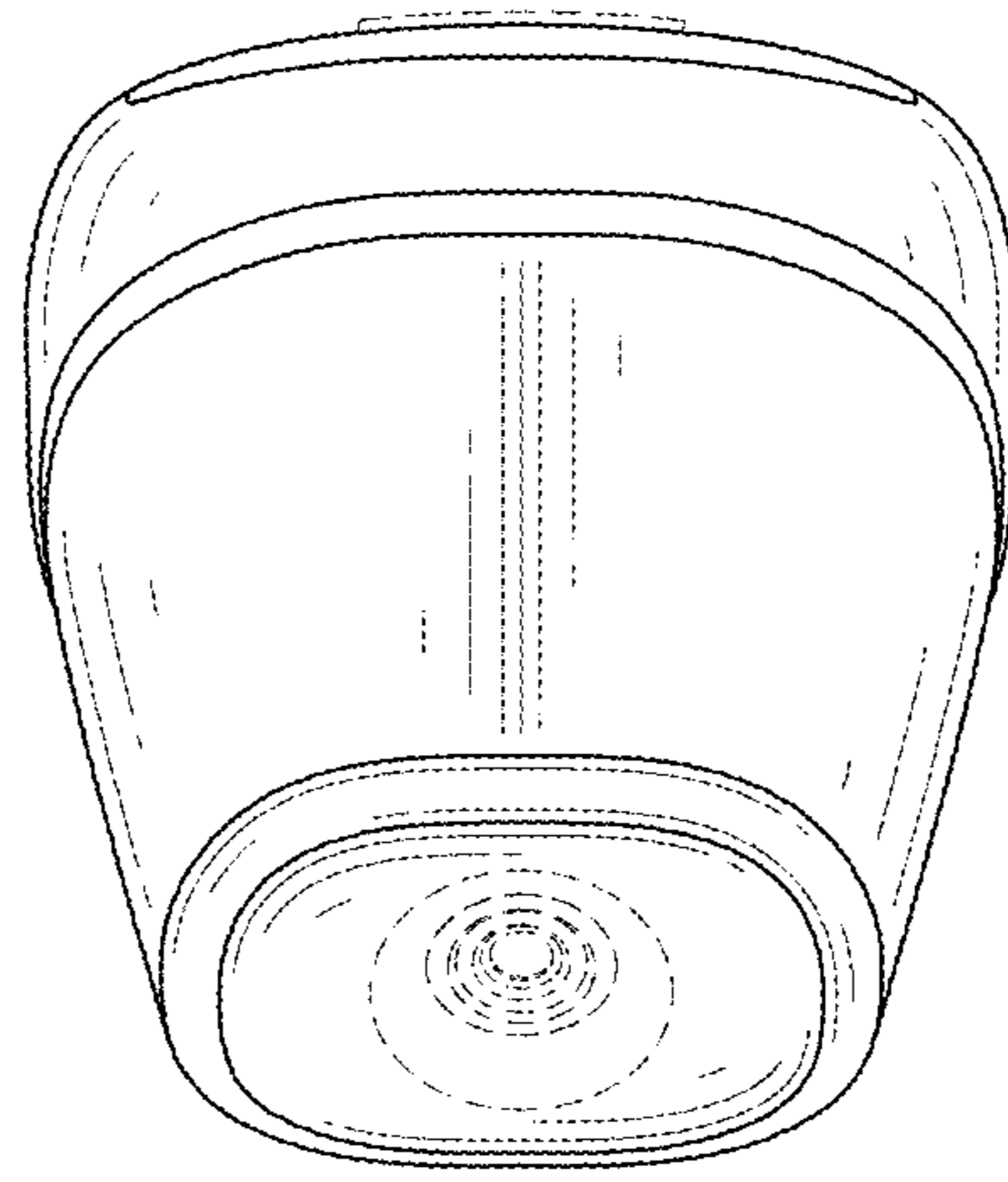

FIG. 7

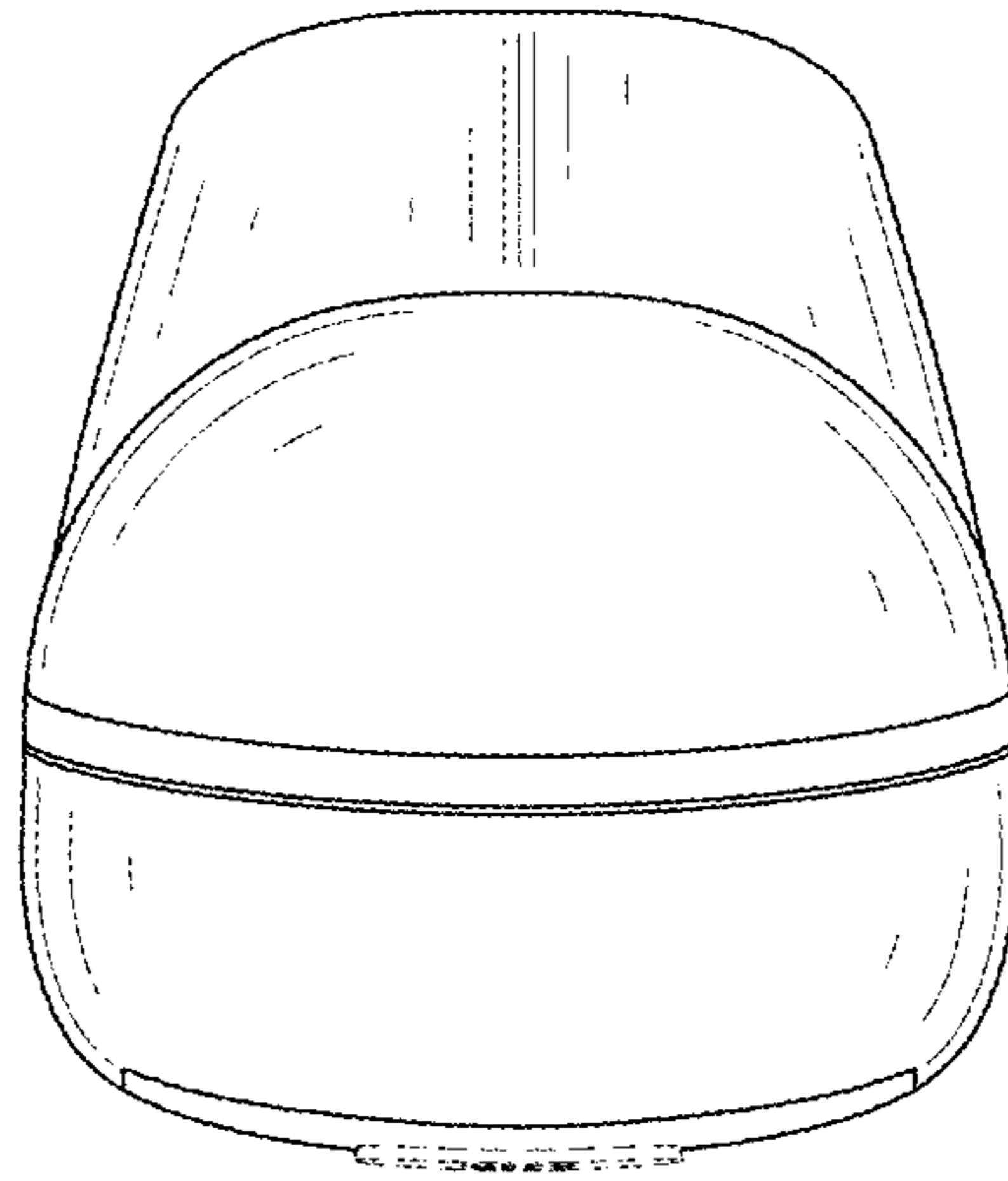

FIG. 8