



US00D891919S

(12) **United States Design Patent**
Sill et al.

(10) **Patent No.:** **US D891,919 S**
(45) **Date of Patent:** **** Aug. 4, 2020**

(54) **CARTON**

DESCRIPTION

(71) Applicant: **Inno-Pak, LLC**, Delaware, OH (US)
(72) Inventors: **Jonathan D. Sill**, Delaware, OH (US);
Steven A. Mayer, Indianapolis, IN (US)
(73) Assignee: **INNO-PAK, LLC**, Delaware, OH (US)
(**) Term: **15 Years**
(21) Appl. No.: **29/655,771**
(22) Filed: **Jul. 6, 2018**
(51) **LOC (12) Cl.** **09-03**
(52) **U.S. Cl.**
USPC **D9/432; D9/751; D9/418**
(58) **Field of Classification Search**
USPC D9/414-423, 424-429, 430-433, 434,
D9/456, 457, 711, 713, 721-722, 737,
(Continued)

(56) **References Cited**

U.S. PATENT DOCUMENTS

2,222,211 A * 11/1940 Arneson B65D 71/0051
206/170
D182,375 S 3/1958 Moore
(Continued)

OTHER PUBLICATIONS

Paperboard 4 Corner. [online] Published on Jan. 19, 2017. Retrieved Aug. 1, 2019 from URL: <https://www.amazon.com/Paperboard-Stadium-Theater-MT-Products/dp/B074MLNQQ2>.
(Continued)

Primary Examiner — Vy N Koenig
(74) *Attorney, Agent, or Firm* — Ward & Smith, PA;
Ryan K. Simmons

(57) **CLAIM**

The ornamental design for a carton, as shown and described.

FIG. 1 is a perspective view of a carton showing the new design;
FIG. 2 is a another perspective view thereof;
FIG. 3 is a front elevation view thereof;
FIG. 4 is a rear elevation view thereof;
FIG. 5 is a right side elevation view thereof;
FIG. 6 is a left side elevation view thereof;
FIG. 7 is a top plan view thereof;
FIG. 8 is bottom plan view thereof;
FIG. 9 is another perspective view of the carton of FIG. 1 shown in an open configuration;
FIG. 10 is a front elevation view thereof;
FIG. 11 is a rear elevation view thereof;
FIG. 12 is a right side elevation view thereof;
FIG. 13 is a left side elevation view thereof;
FIG. 14 is a top plan view thereof;
FIG. 15 is bottom plan view thereof;
FIG. 16 is another top plan view of the carton of FIG. 9 showing an alternate embodiment;
FIG. 17 is another bottom plan view of the carton of FIG. 9 showing an alternate embodiment;
FIG. 18 is another perspective view of the carton of FIG. 1 shown in an alternate configuration;
FIG. 19 is a rear perspective view thereof;
FIG. 20 is a front elevation view thereof;
FIG. 21 is a rear elevation view thereof;
FIG. 22 is a right side elevation view thereof;
FIG. 23 is a left side elevation view thereof;
FIG. 24 is a top plan view thereof;
FIG. 25 is bottom plan view thereof;
FIG. 26 is another perspective view of the carton of FIG. 18 showing an container housed therein;
FIG. 27 is another perspective view of the carton of FIG. 18 shown in an open configuration;
FIG. 28 is a front elevation view thereof;
FIG. 29 is a rear elevation view thereof;
FIG. 30 is a right side elevation view thereof;
FIG. 31 is a left side elevation view thereof;
FIG. 32 is a top plan view thereof;
FIG. 33 is bottom plan view thereof;
FIG. 34 is another top plan view of the carton of FIG. 27 showing an alternate embodiment;

(Continued)

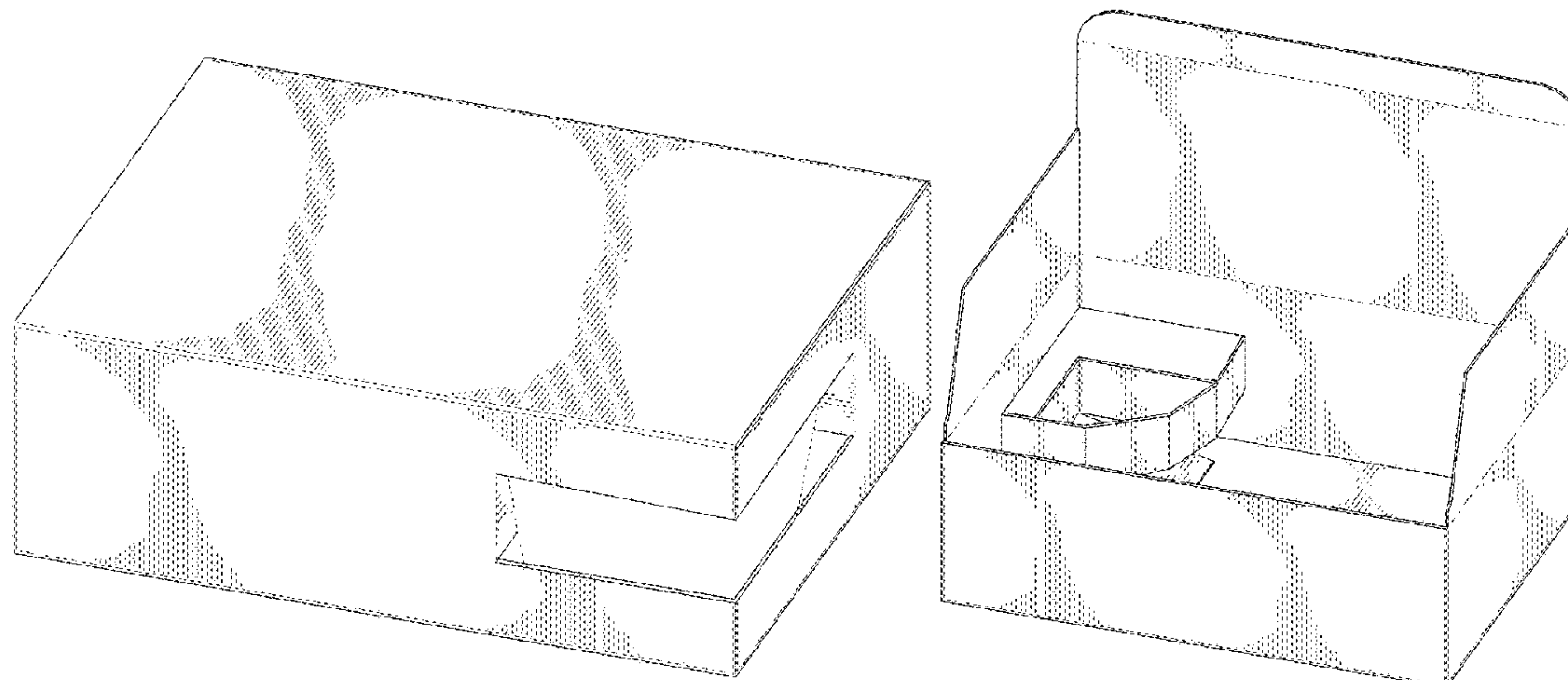

FIG. 35 is another bottom plan view of the carton of FIG. 27 showing an alternate embodiment; and, FIG. 36 is another perspective view of the carton of FIG. 27 showing a container housed therein. In the Figures, the dash-dash broken lines are for the purpose of illustrating environment and form no part of the claimed design, and the dot dot lines illustrate perforations and form part of the claimed design.

1 Claim, 30 Drawing Sheets

(58) Field of Classification Search

USPC D9/751-755; D3/272-274, 290, 304, D3/305, 315; D20/10, 22, 27, 40, 42
 CPC ... B65D 5/00; B65D 5/02; B65D 5/18; B65D 5/20

See application file for complete search history.

(56) References Cited

U.S. PATENT DOCUMENTS

D242,901 S	1/1977	Lohrbach	
D259,175 S	5/1981	Austin, Jr.	
4,601,390 A	7/1986	Rosenthal et al.	
D346,738 S *	5/1994	Kinigakis	D9/418
5,392,984 A	2/1995	Yocum	
6,036,085 A	3/2000	Tsao	

D446,448 S	8/2001	Jernigan et al.	
D466,406 S *	12/2002	Solland	D9/415
D466,804 S	12/2002	Solland	
D488,062 S	4/2004	Shannon	
D567,079 S	4/2008	Fant	
D576,482 S	9/2008	DeBusk	
D600,547 S *	9/2009	Cain	D9/418
D630,503 S *	1/2011	Abdalkhani	D9/418
D679,950 S *	4/2013	Cooper	D7/538
D702,546 S *	4/2014	McAdam	D9/418
D744,825 S *	12/2015	Johansen	D9/418
D789,783 S *	6/2017	DeBusk	D9/418
D795,687 S *	8/2017	Pollock	D9/418
D798,142 S	9/2017	Falcon et al.	
D835,982 S *	12/2018	Mayer	D9/418
D845,760 S	4/2019	Oliveira	
D846,982 S *	4/2019	Horne	D9/418
10,322,840 B2	6/2019	Angulo et al.	
D855,453 S *	8/2019	Meyer	D9/418
D863,950 S *	10/2019	Chilton	D9/418
D867,125 S *	11/2019	Sill	D9/418

OTHER PUBLICATIONS

Fresh Flavor Carry Out, 2018 Inno-Pak online catalogue, www.innopak.com, p. 5.
 Sink Paper and Packaging, "02051-300 4-Cup Drink Carrier Handled Field Cont. 200/case", Available at <https://ddi.sinkpaper.com/productdetail2.aspx?dataid=888-02051-300>, accessed on Jul. 23, 2019, 01 page.

* cited by examiner

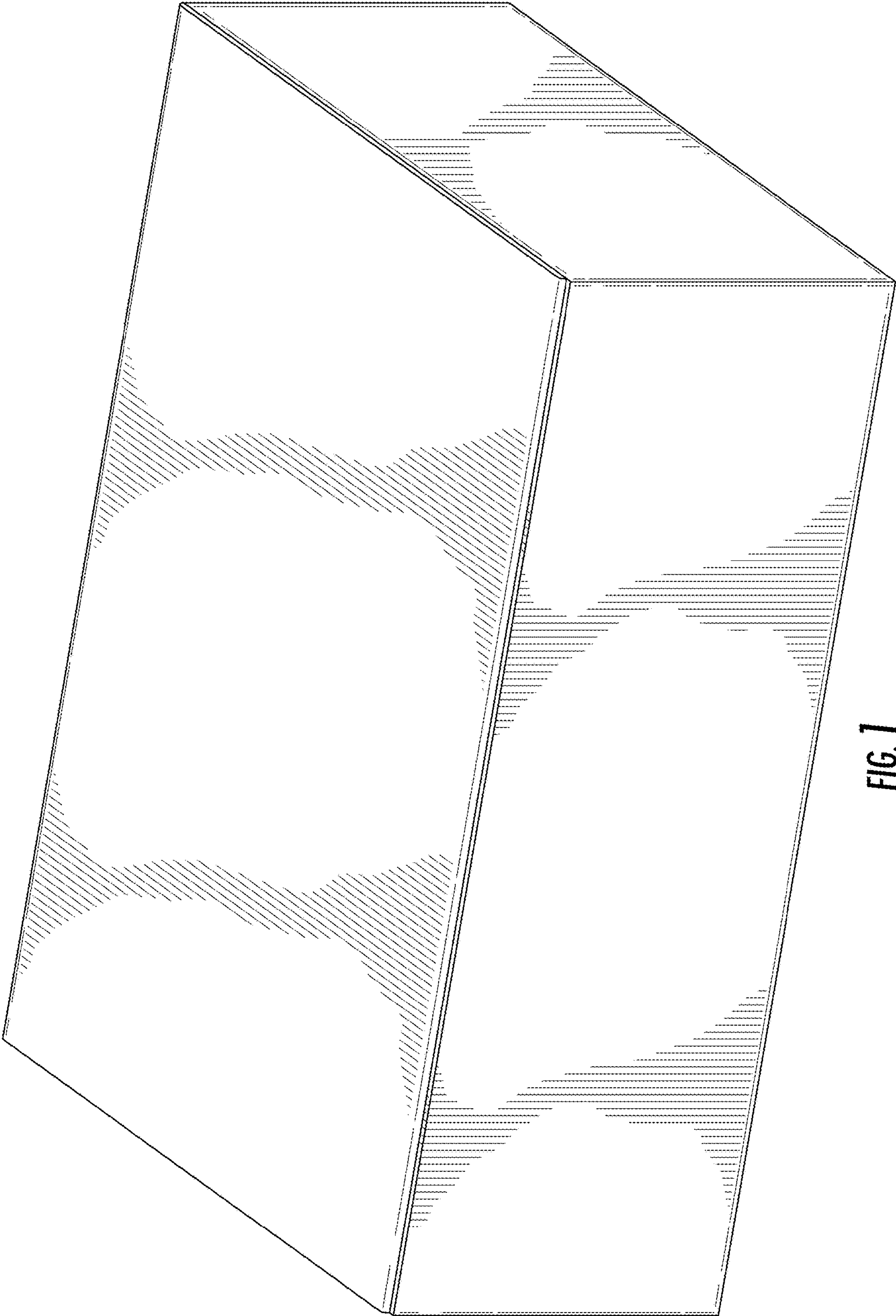

FIG. 1



FIG. 2

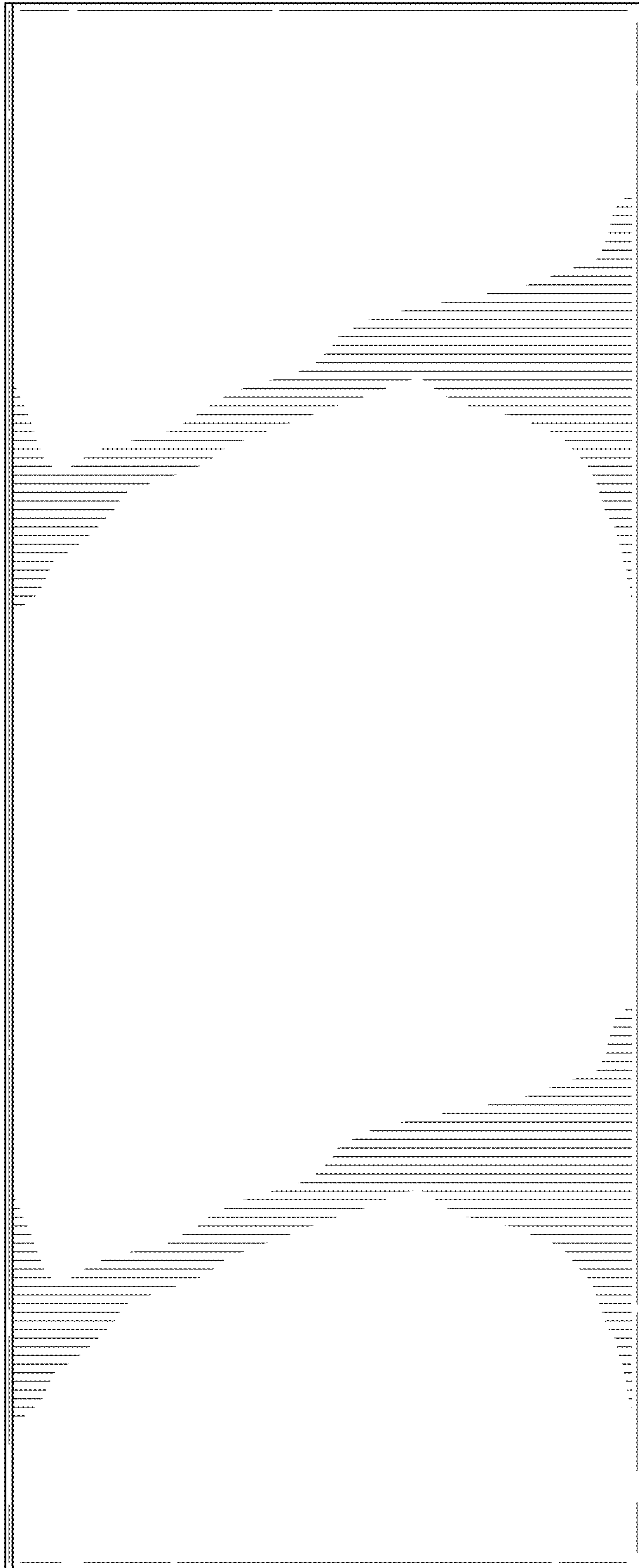

FIG. 3

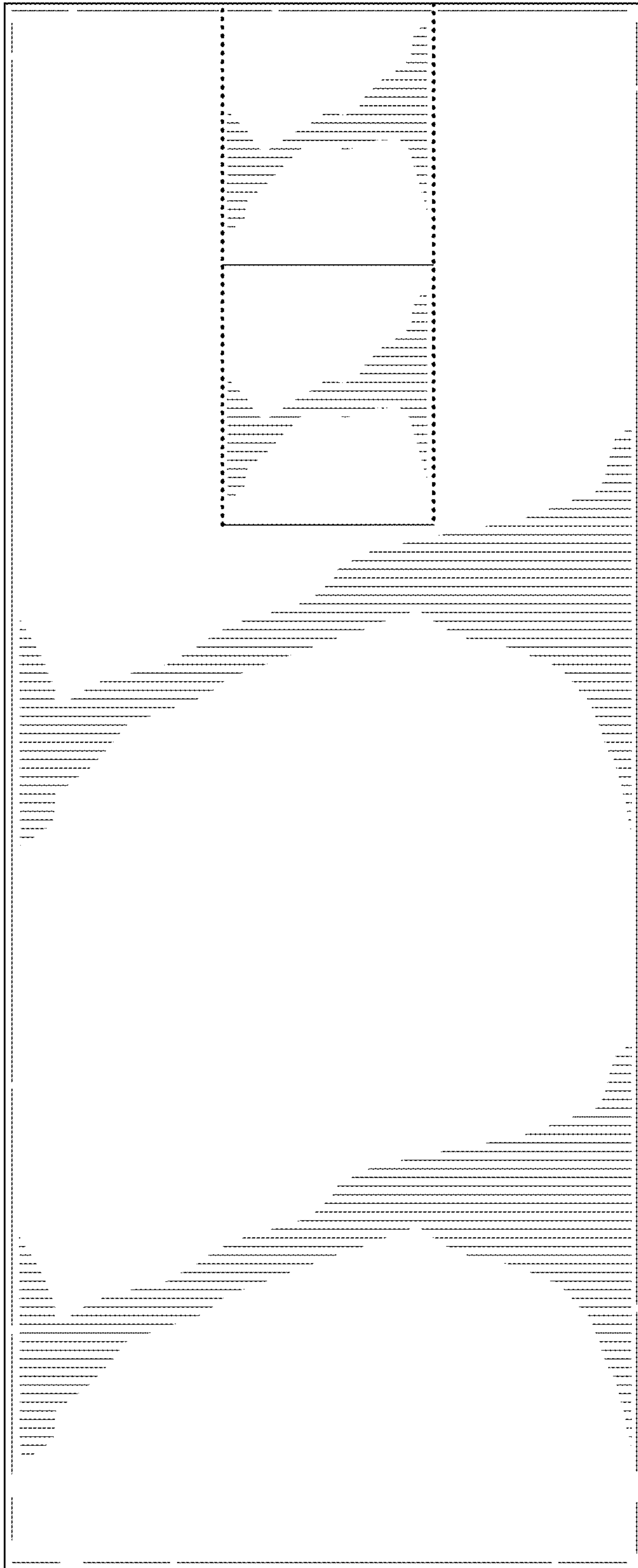

FIG. 4

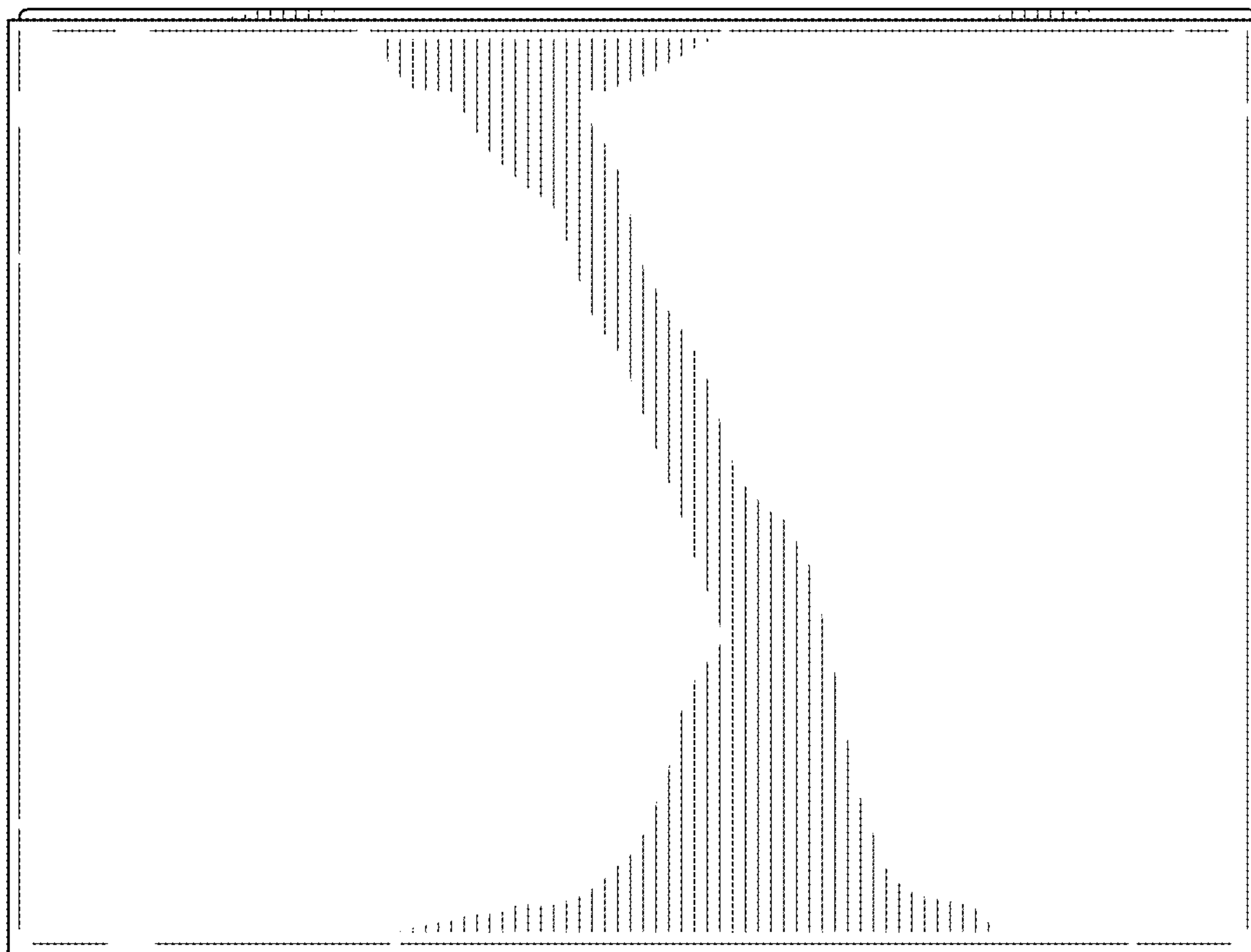

FIG. 5

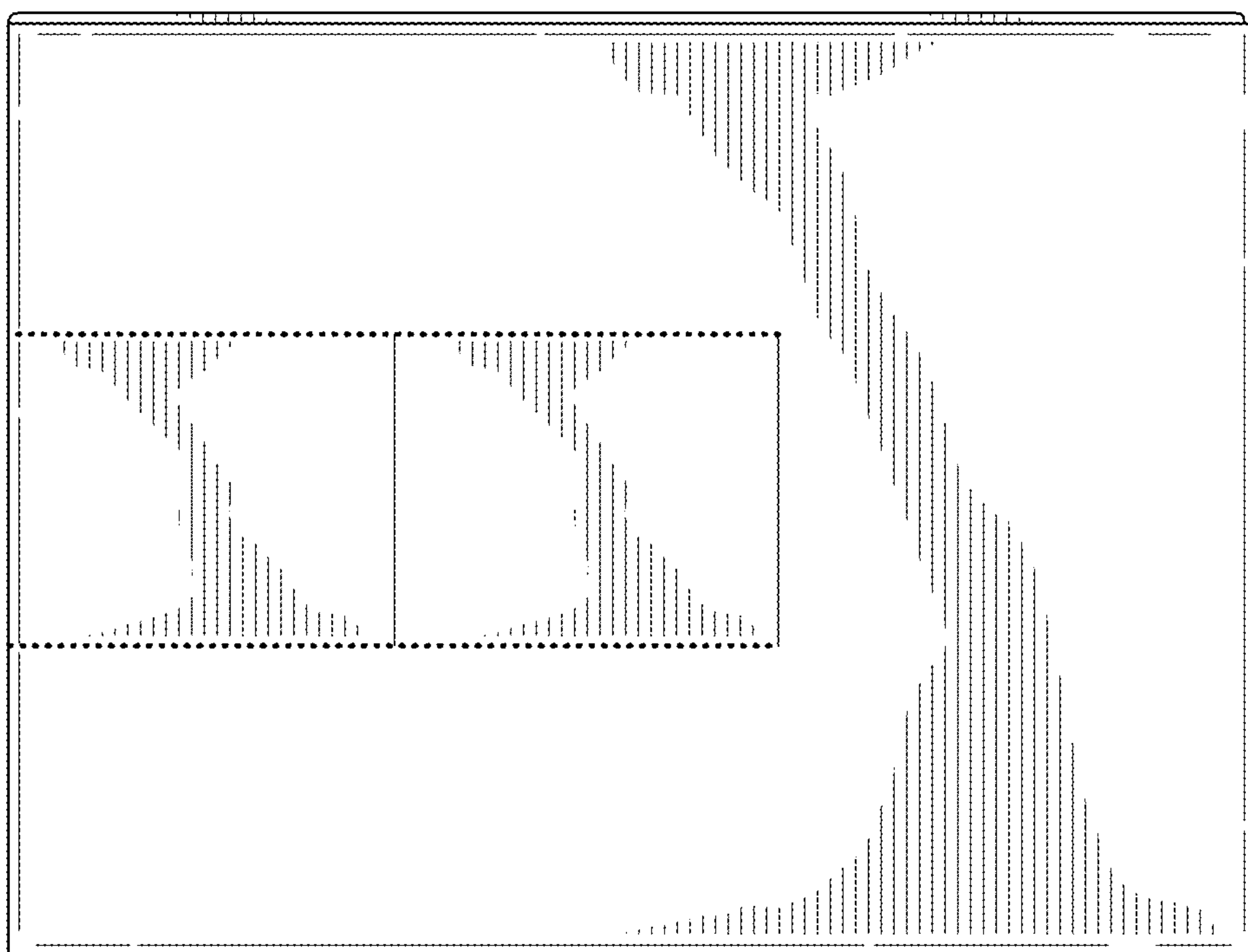

FIG. 6

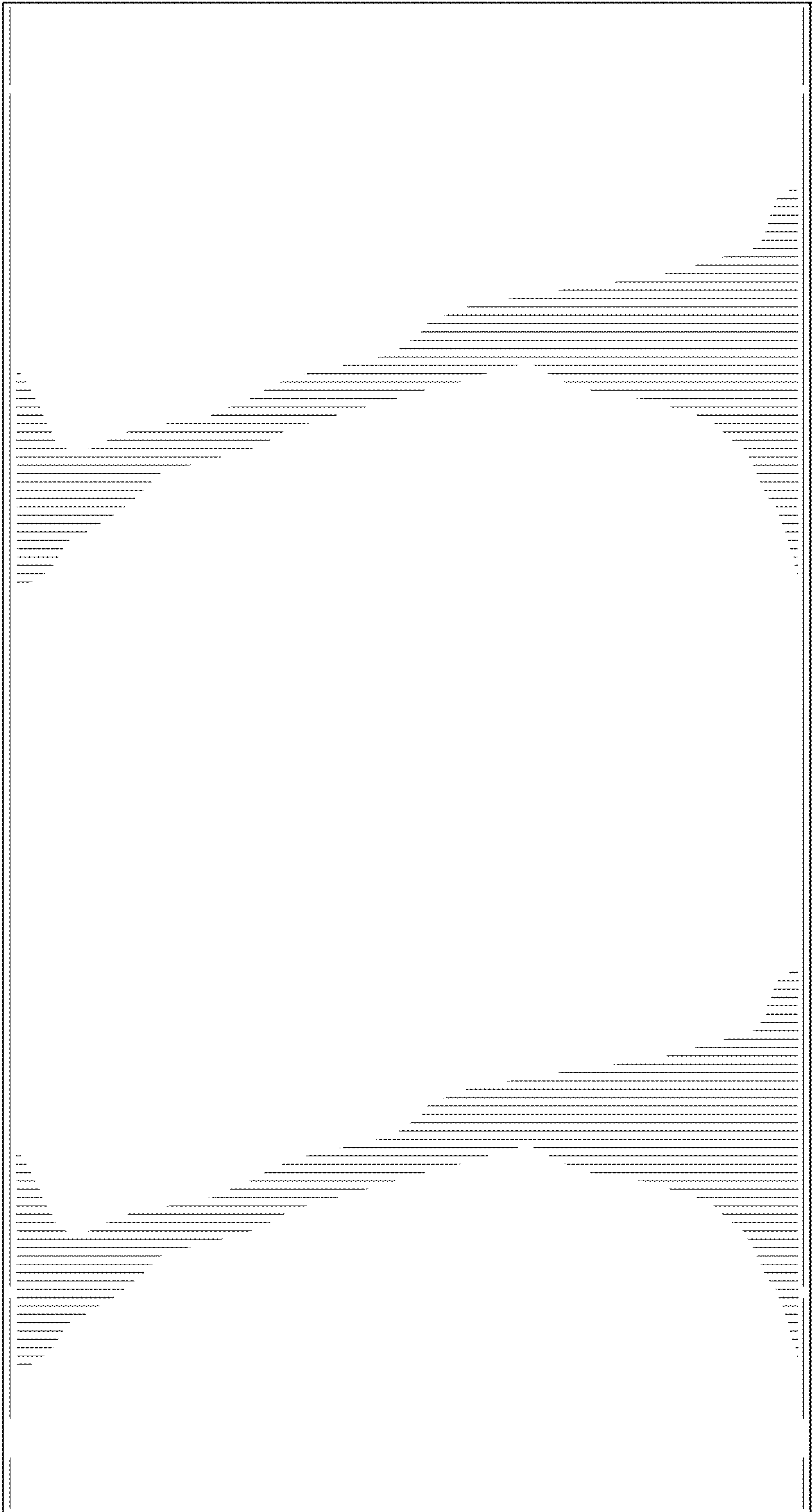

FIG. 7

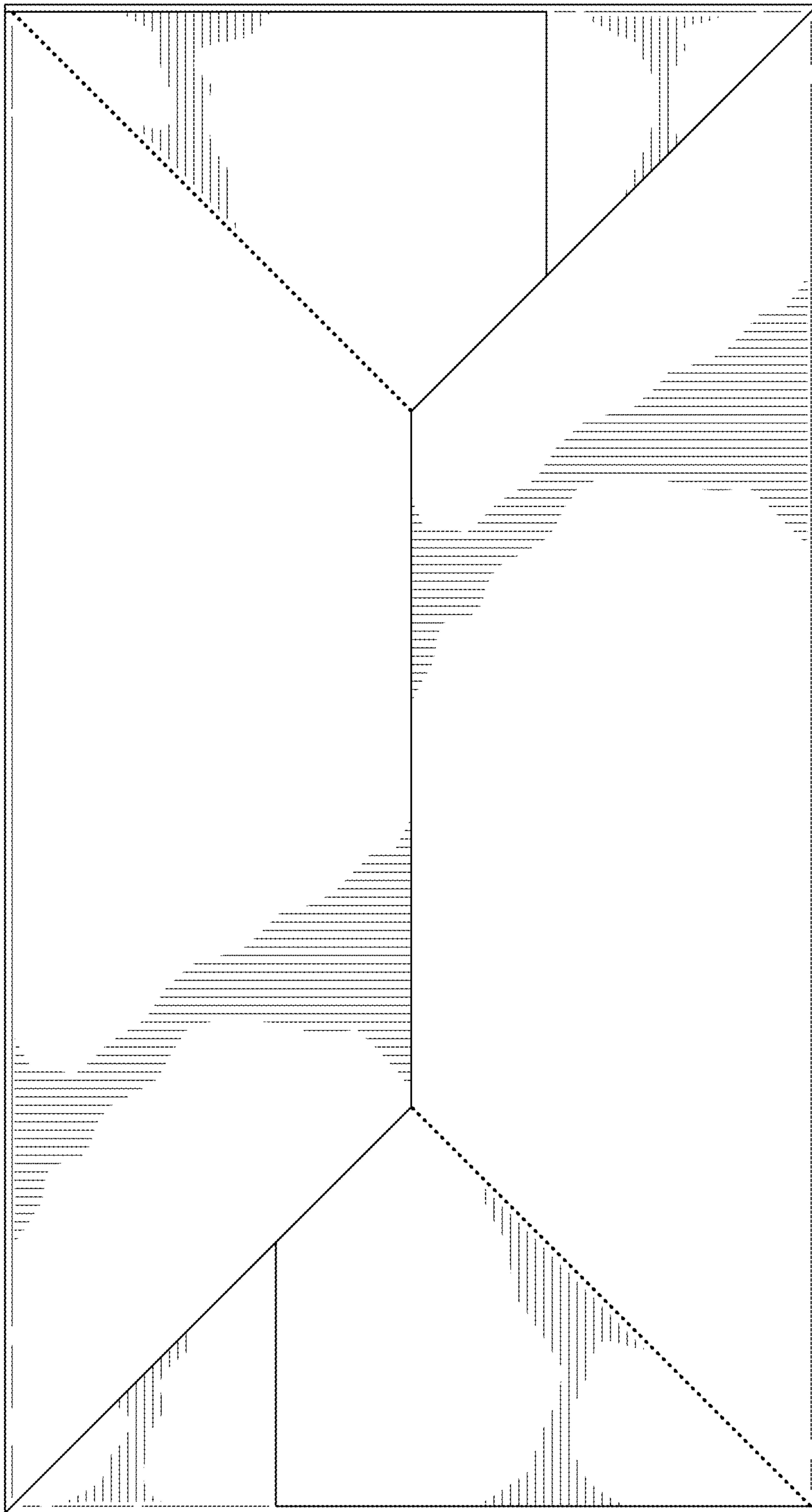

FIG. 8

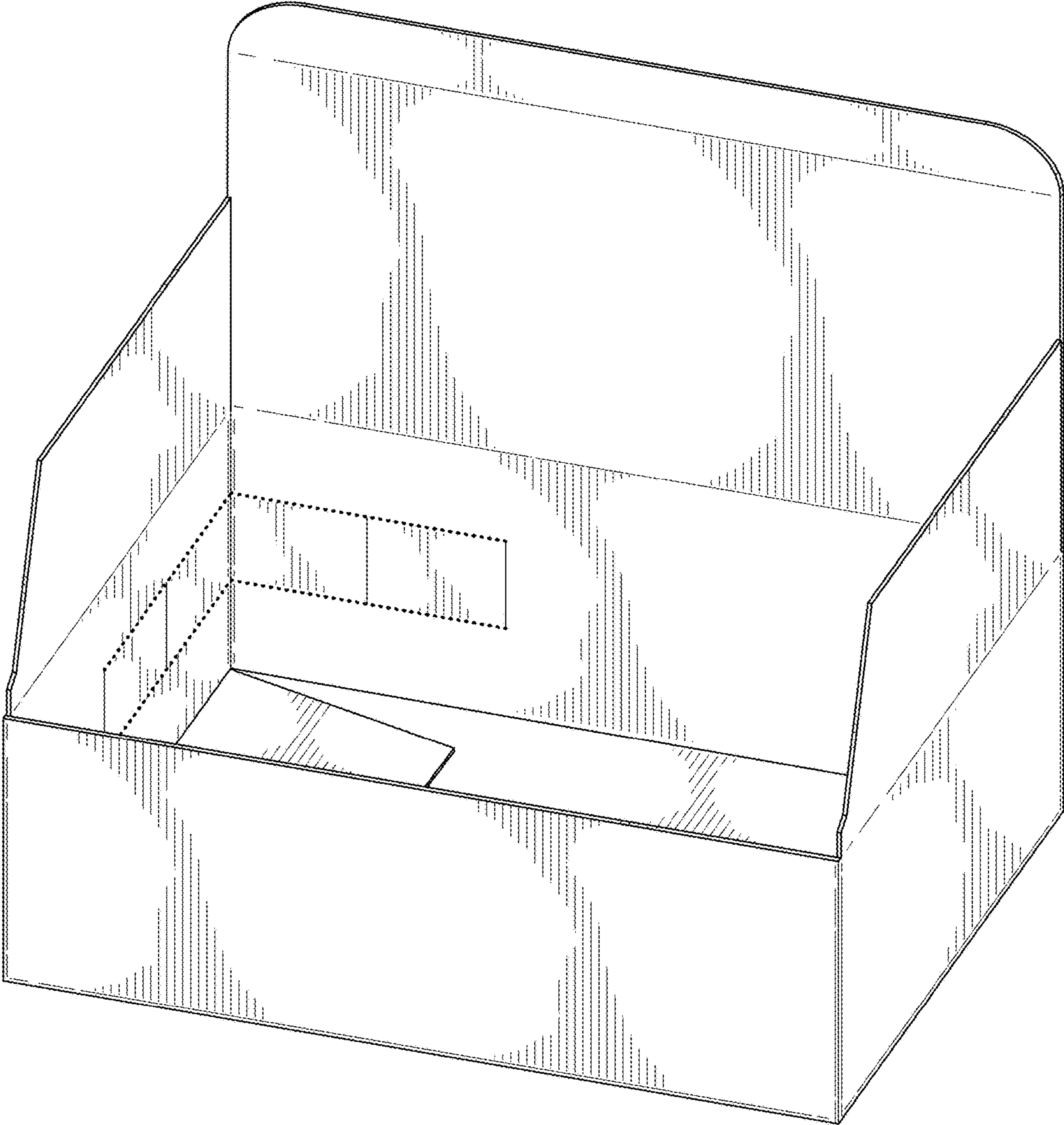

FIG. 9

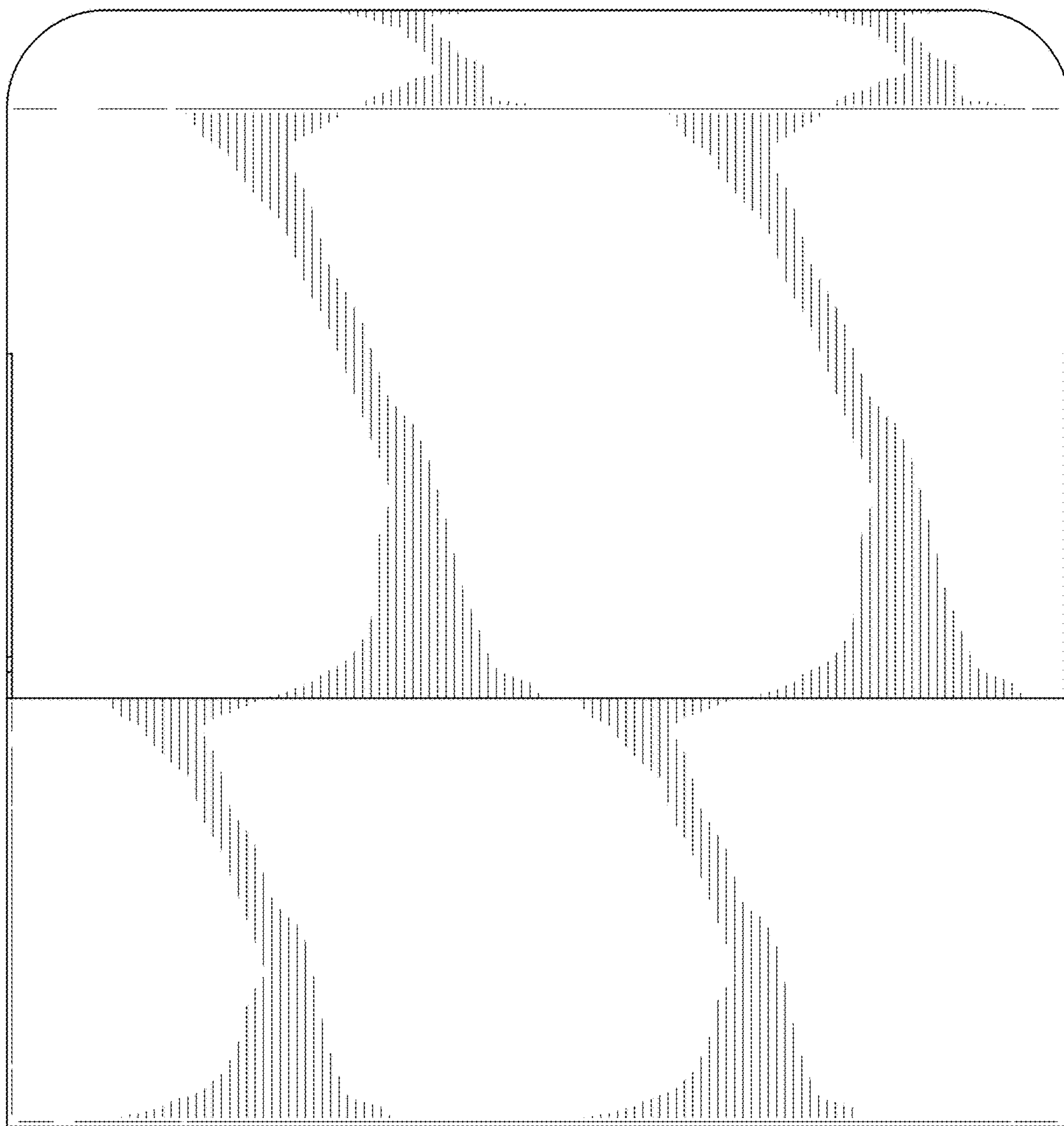

FIG. 10

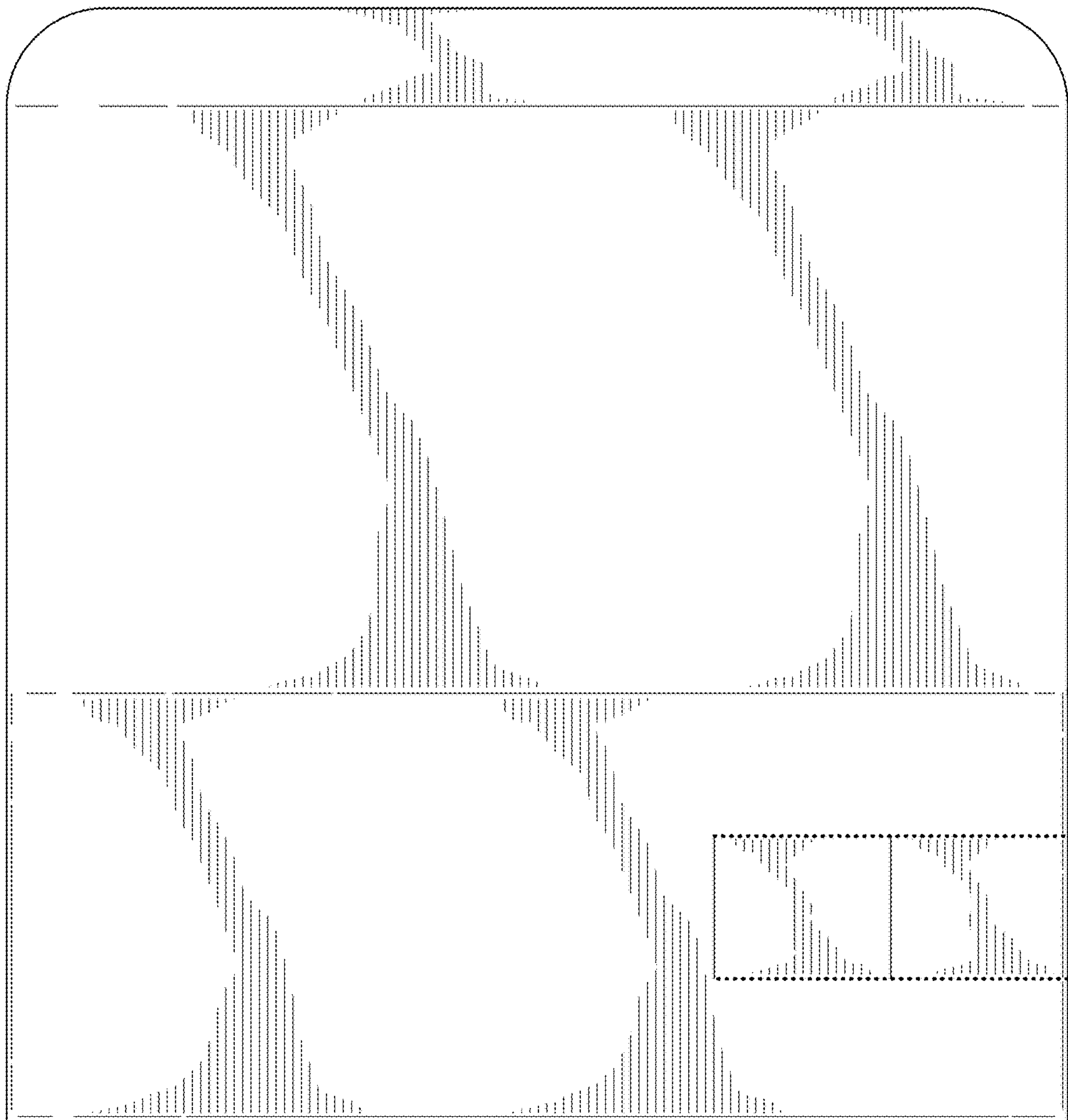

FIG. 11

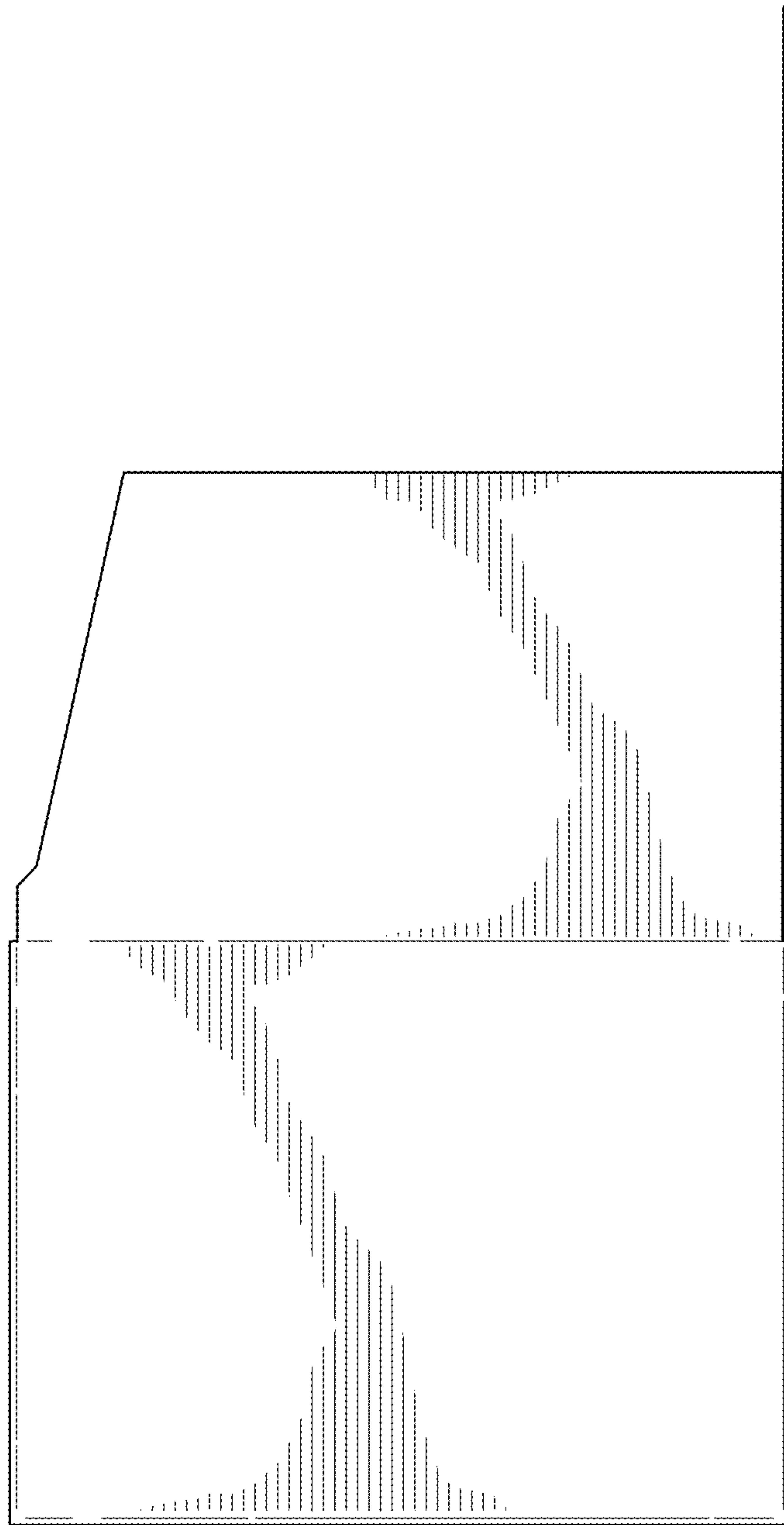

FIG. 12

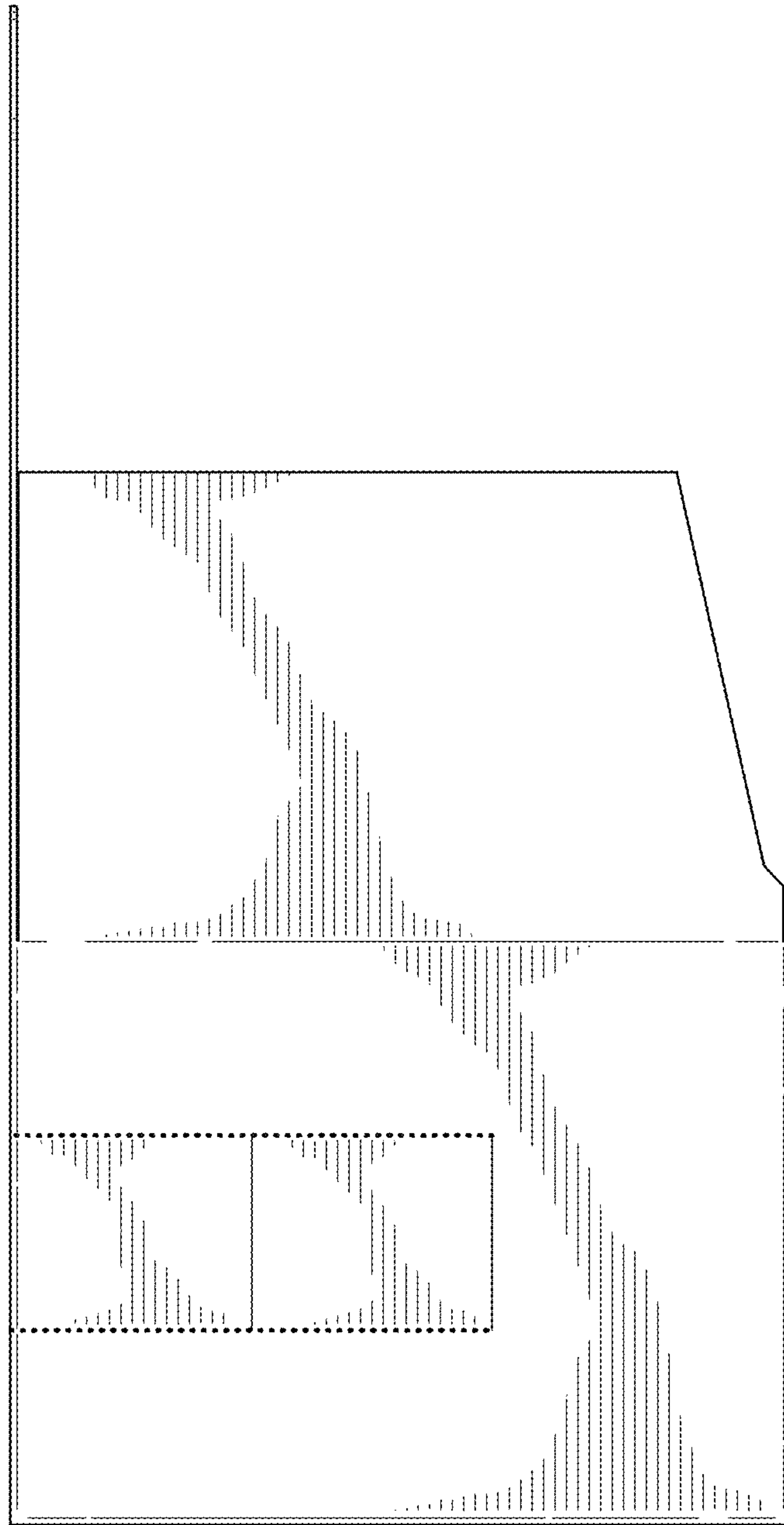

FIG. 13

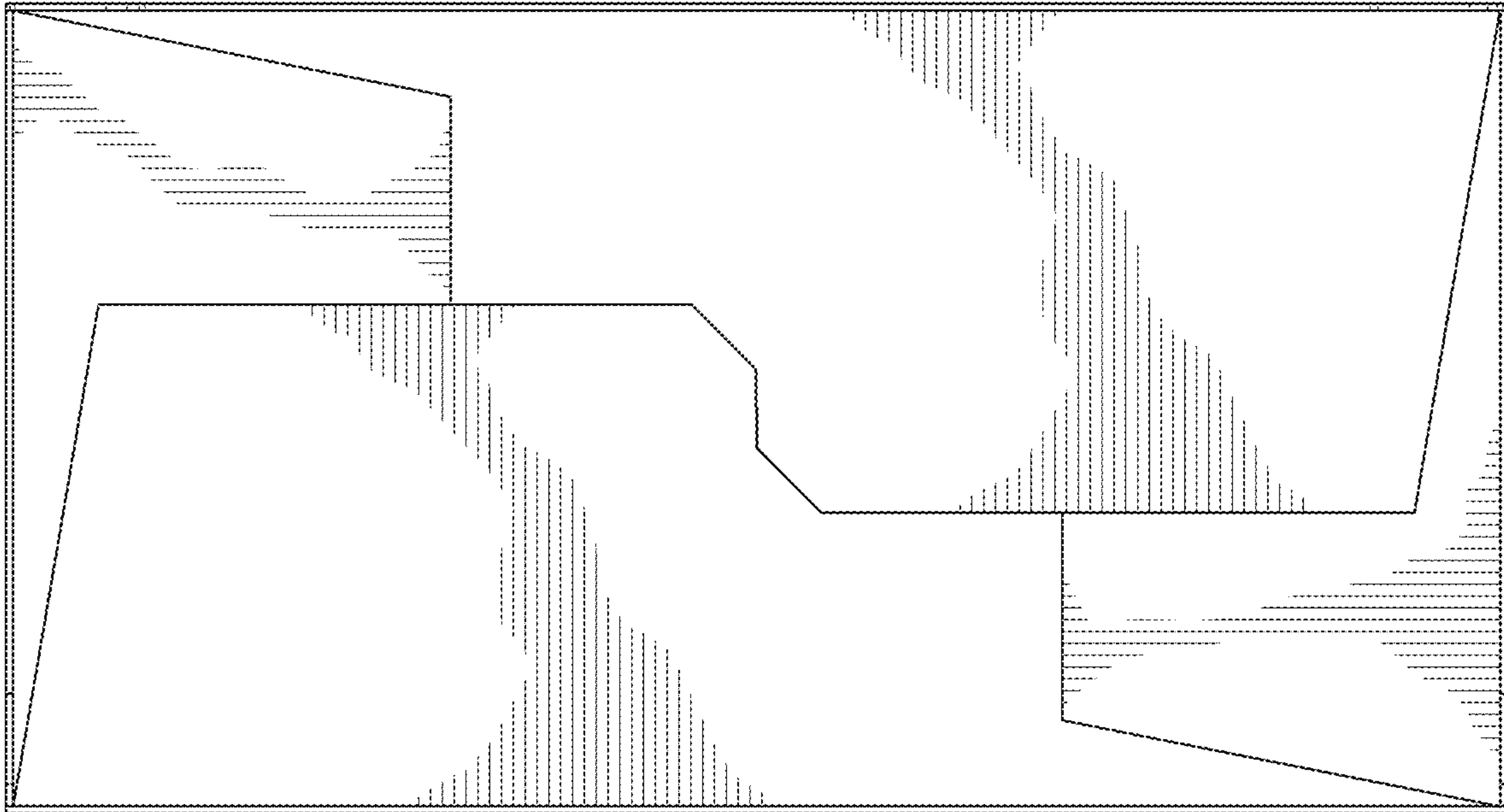

FIG. 14

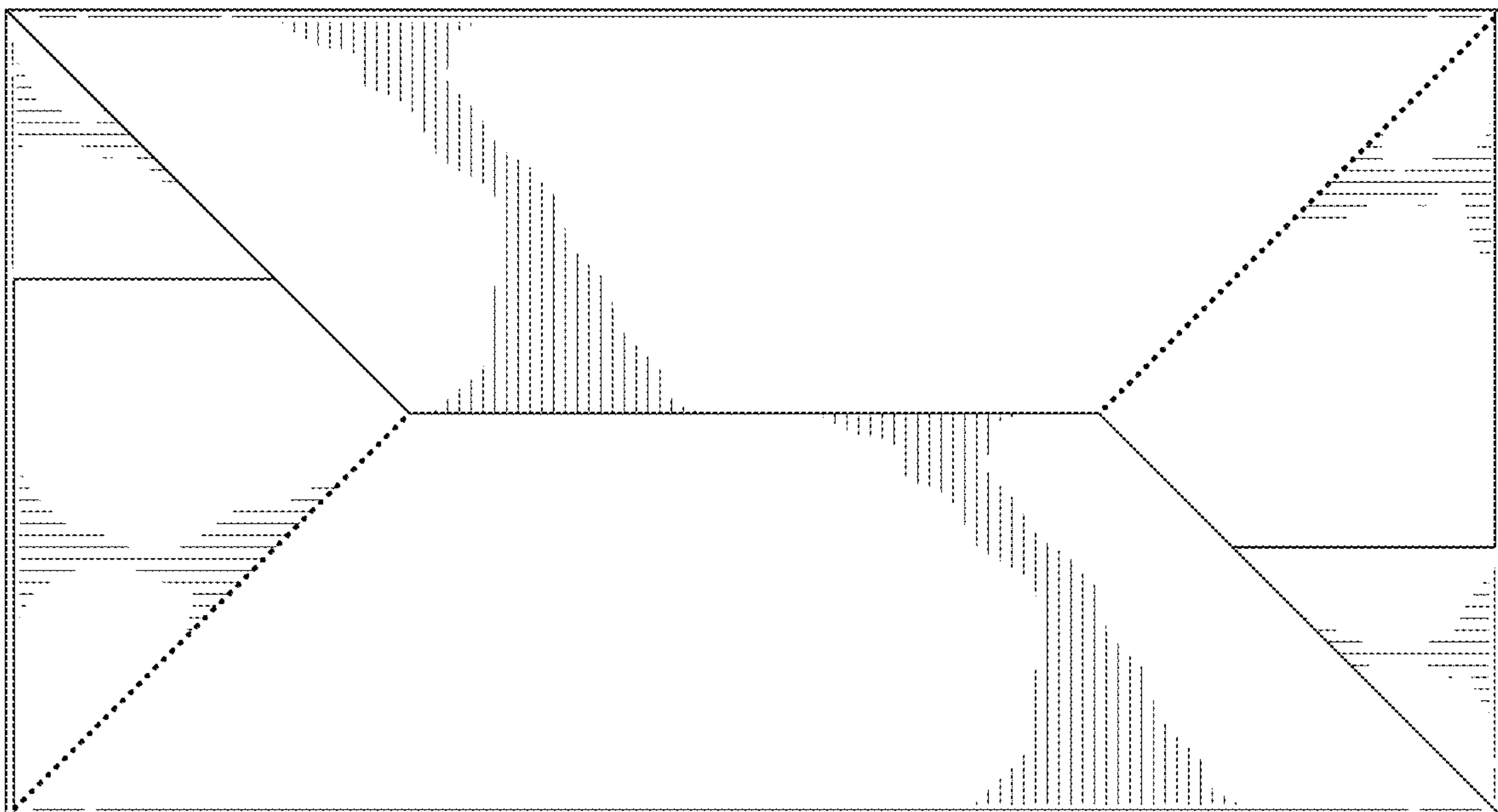

FIG. 15

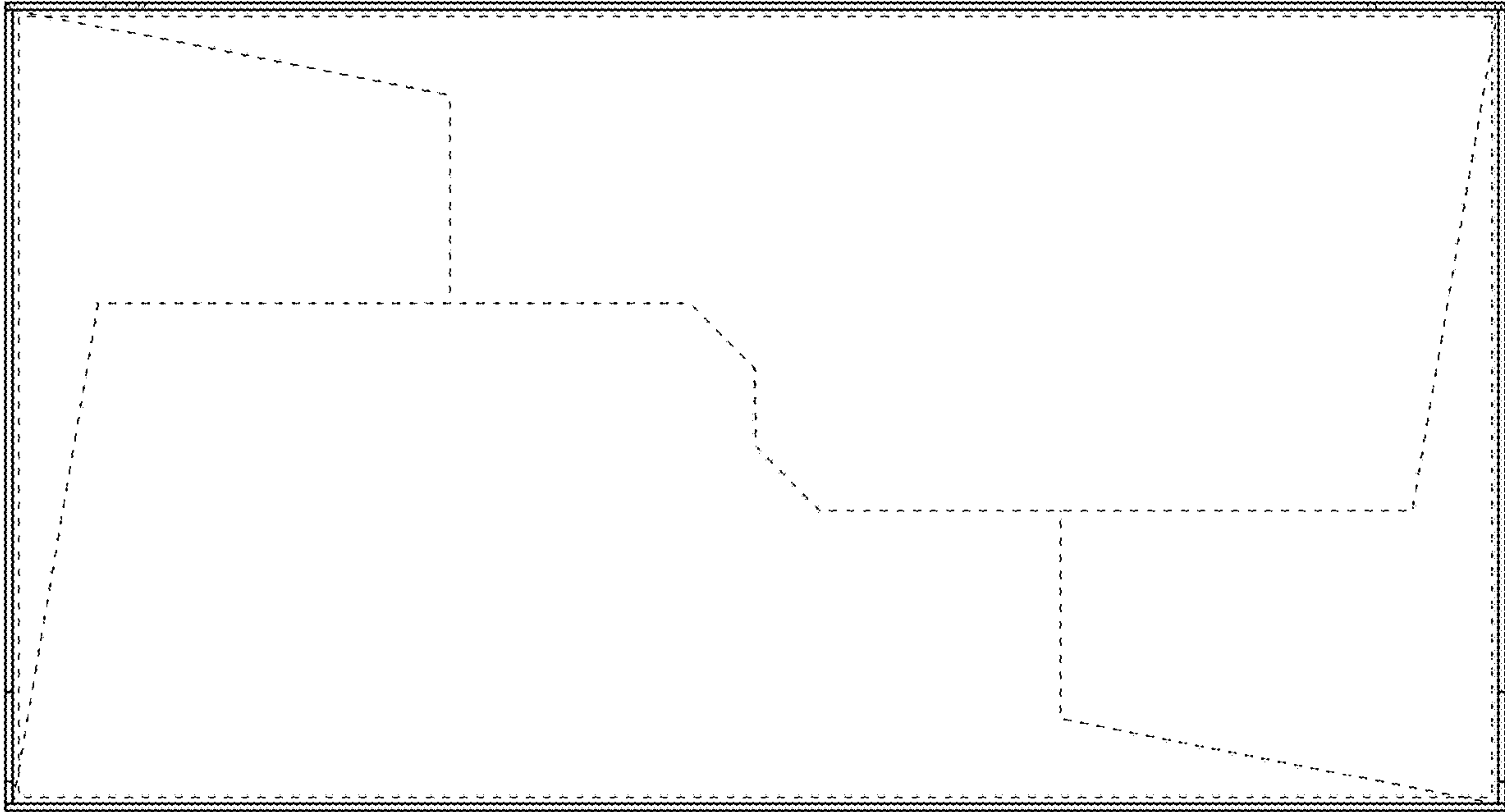

FIG. 16

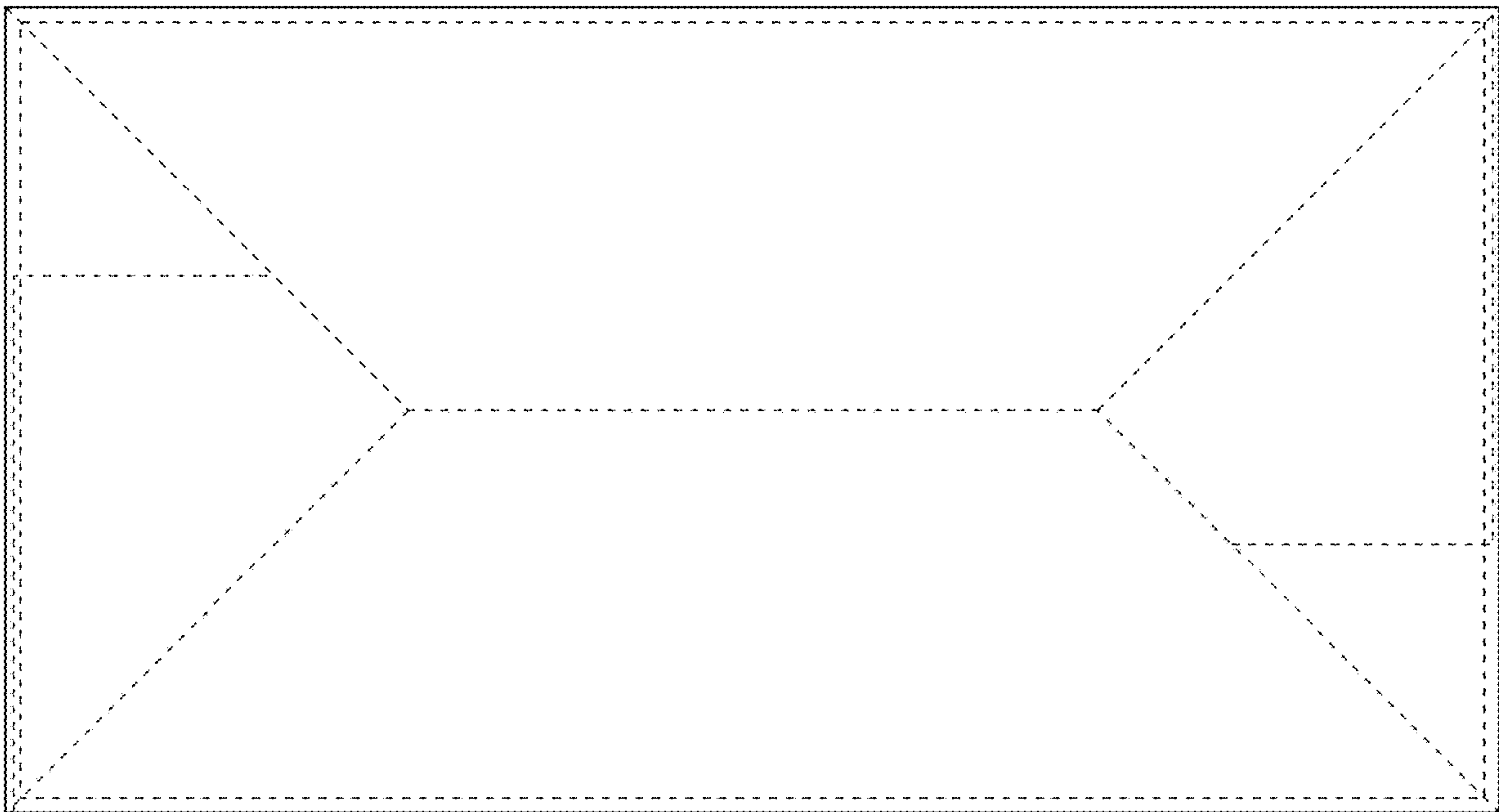

FIG. 17

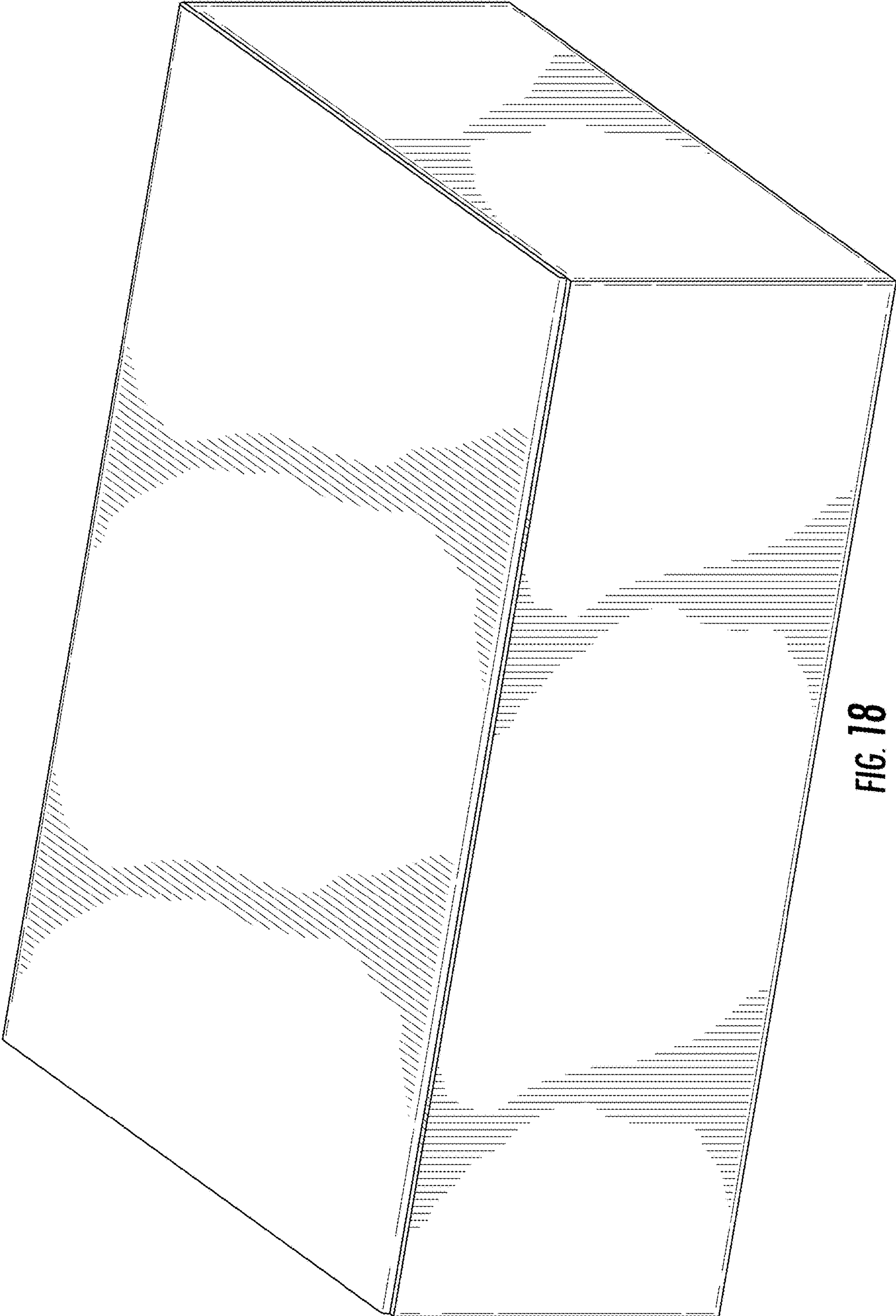

FIG. 18

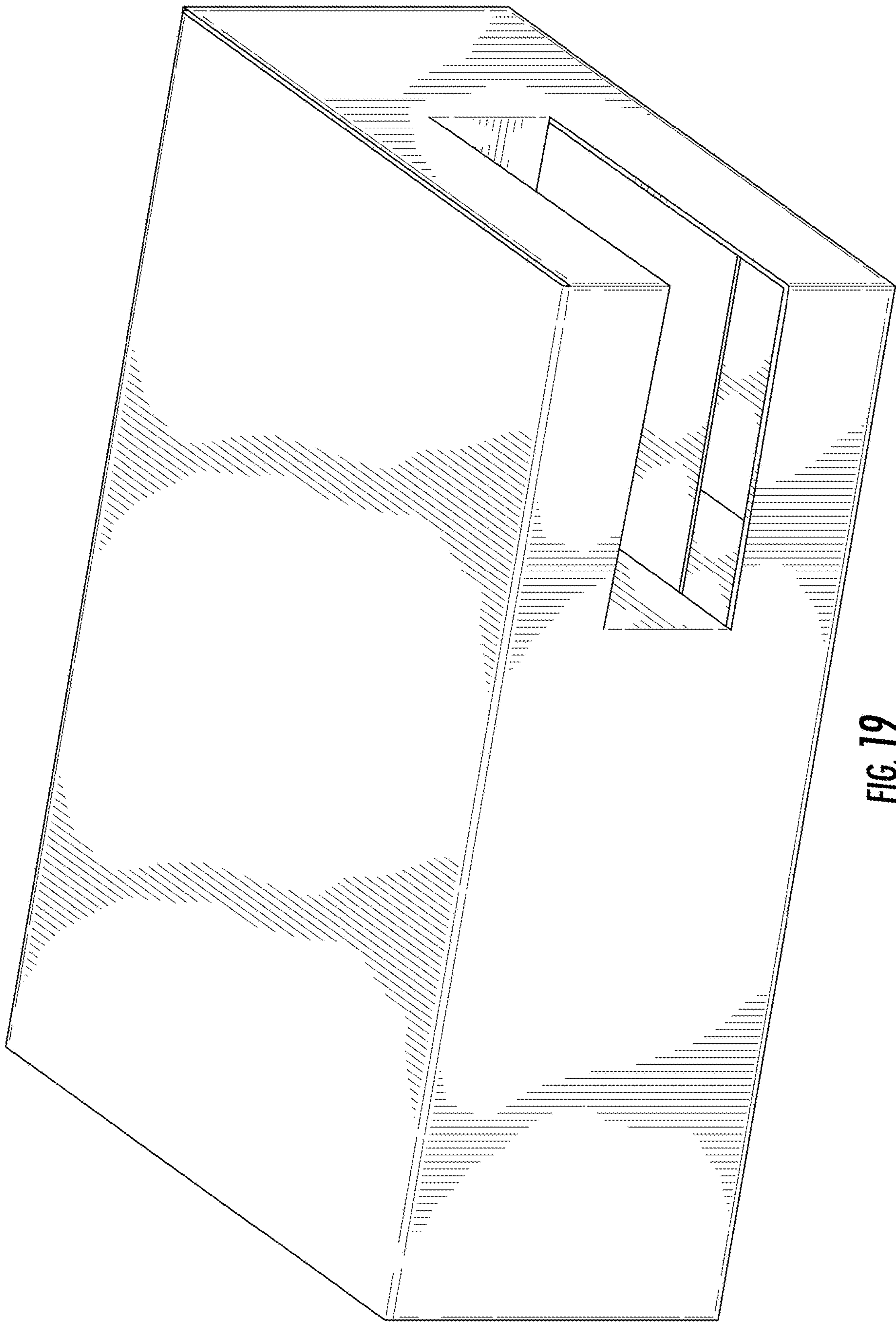

FIG. 19

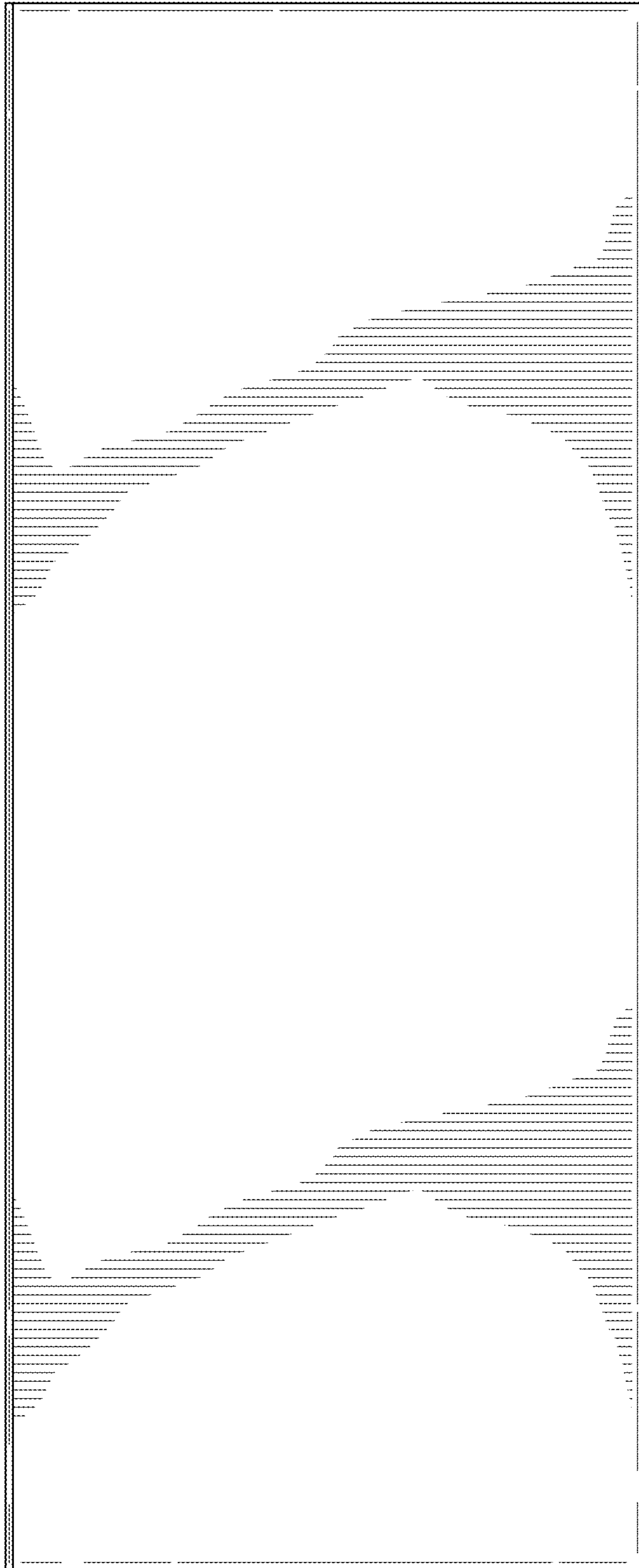

FIG. 20

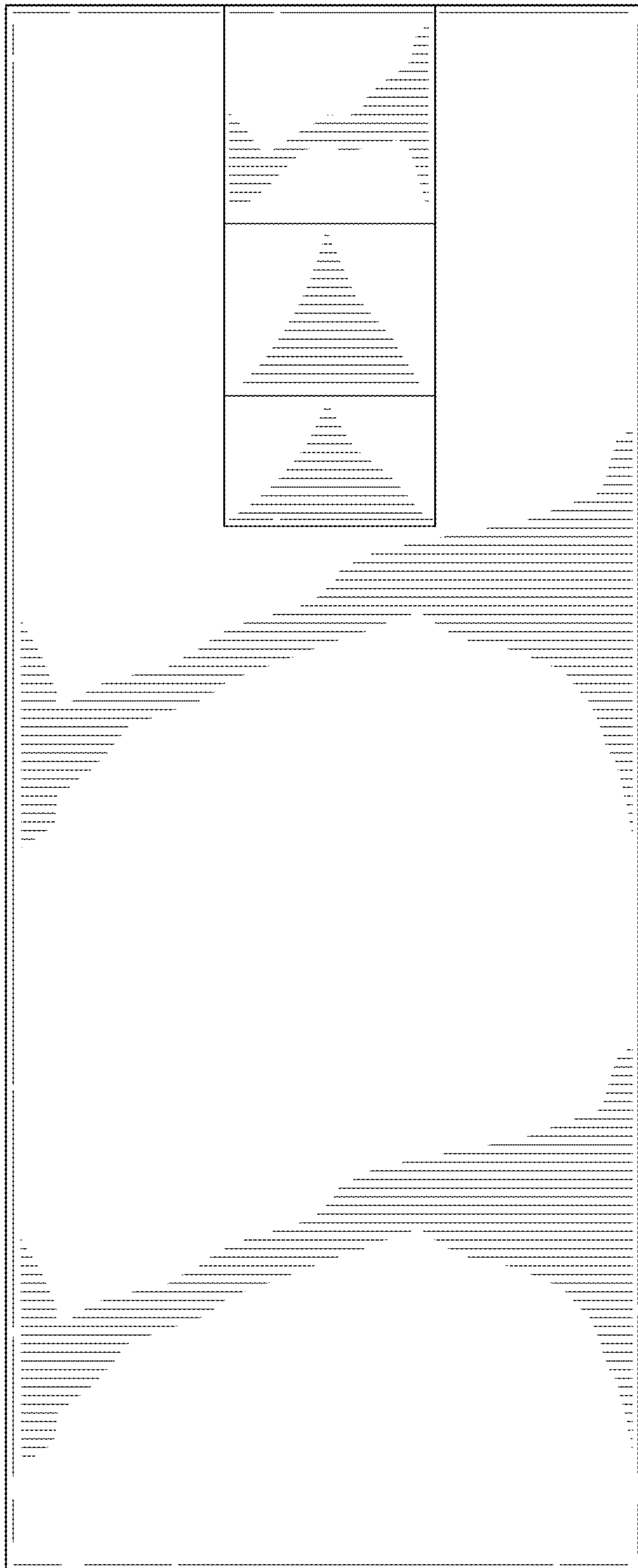

FIG. 21

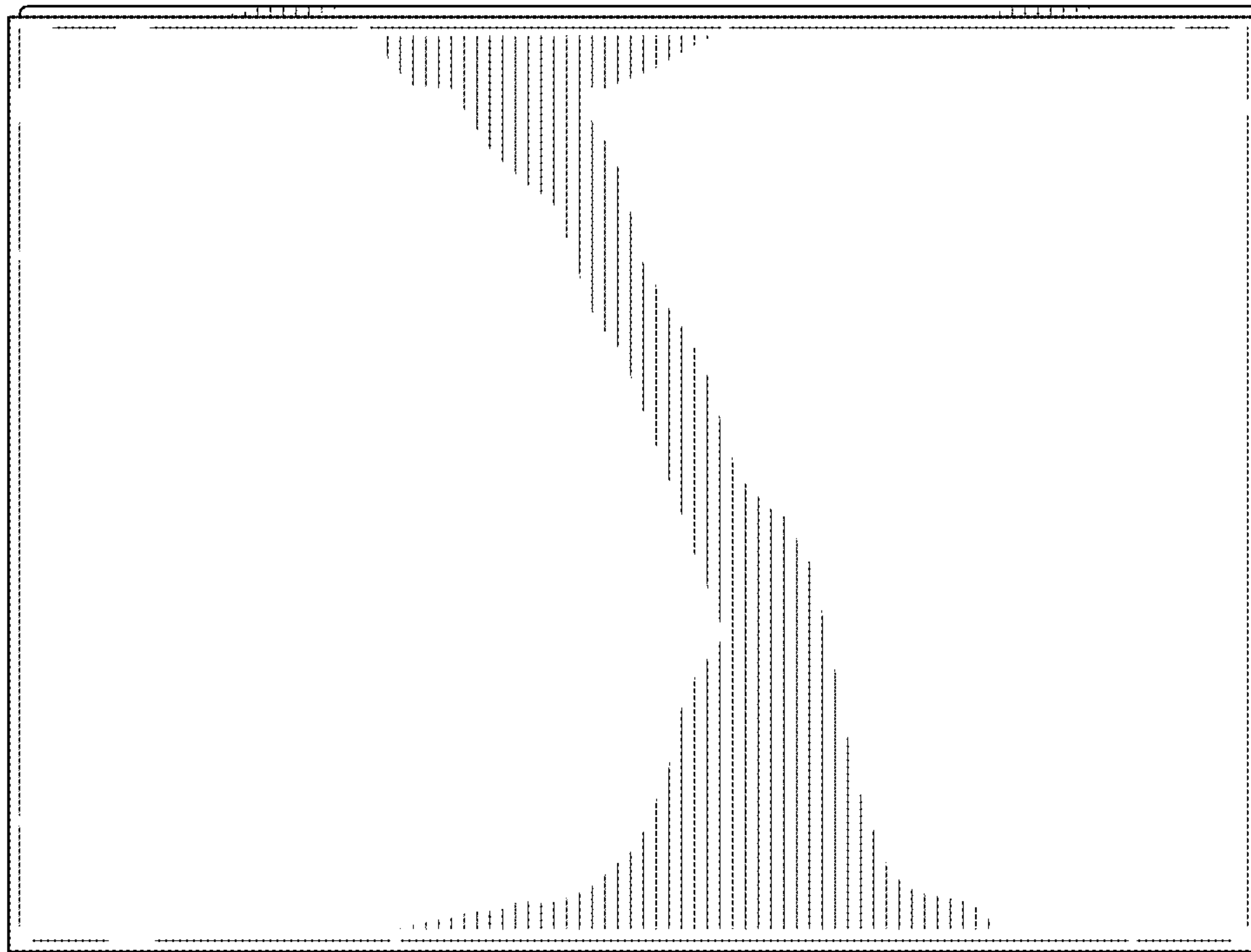

FIG. 22

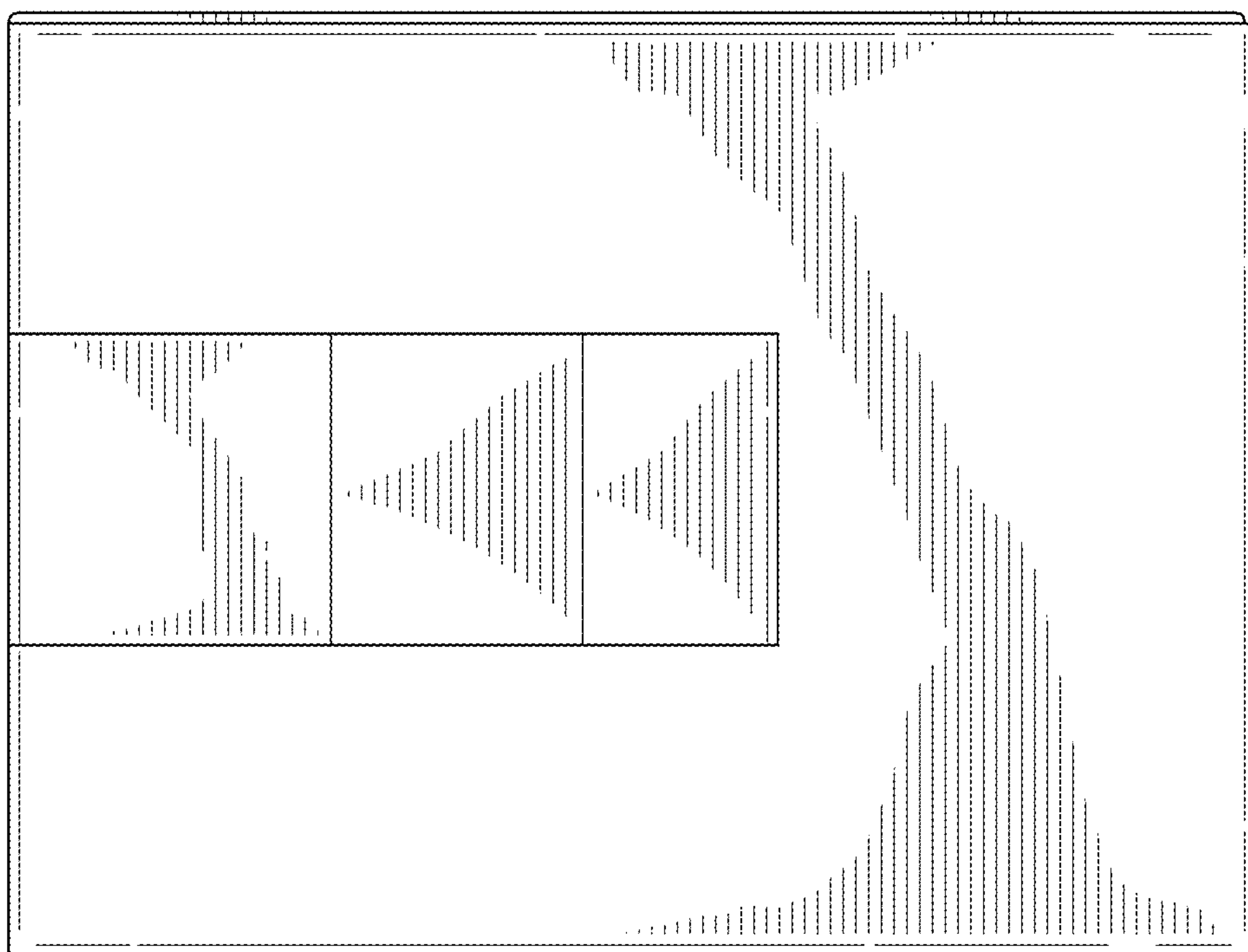

FIG. 23

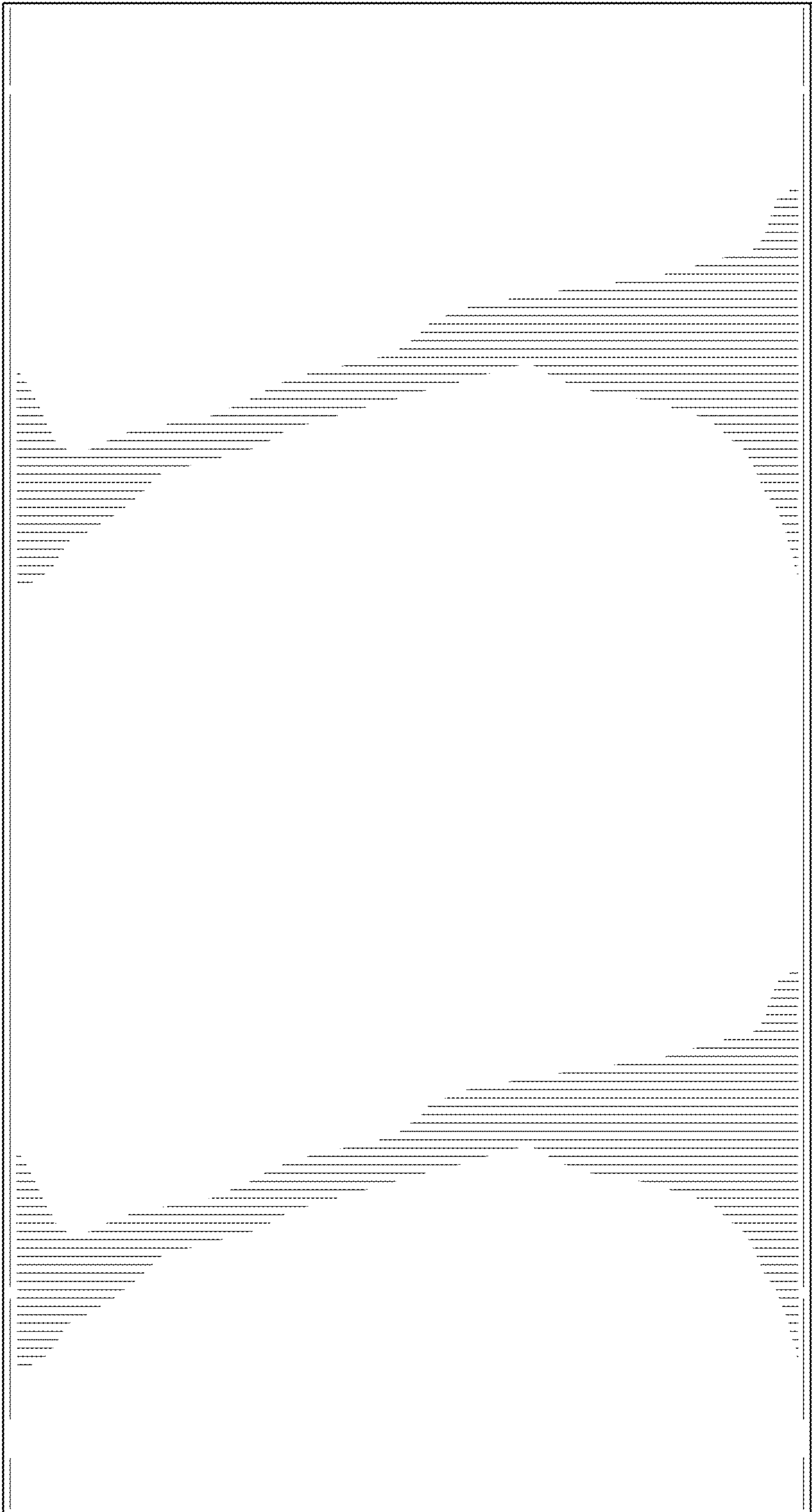

FIG. 24

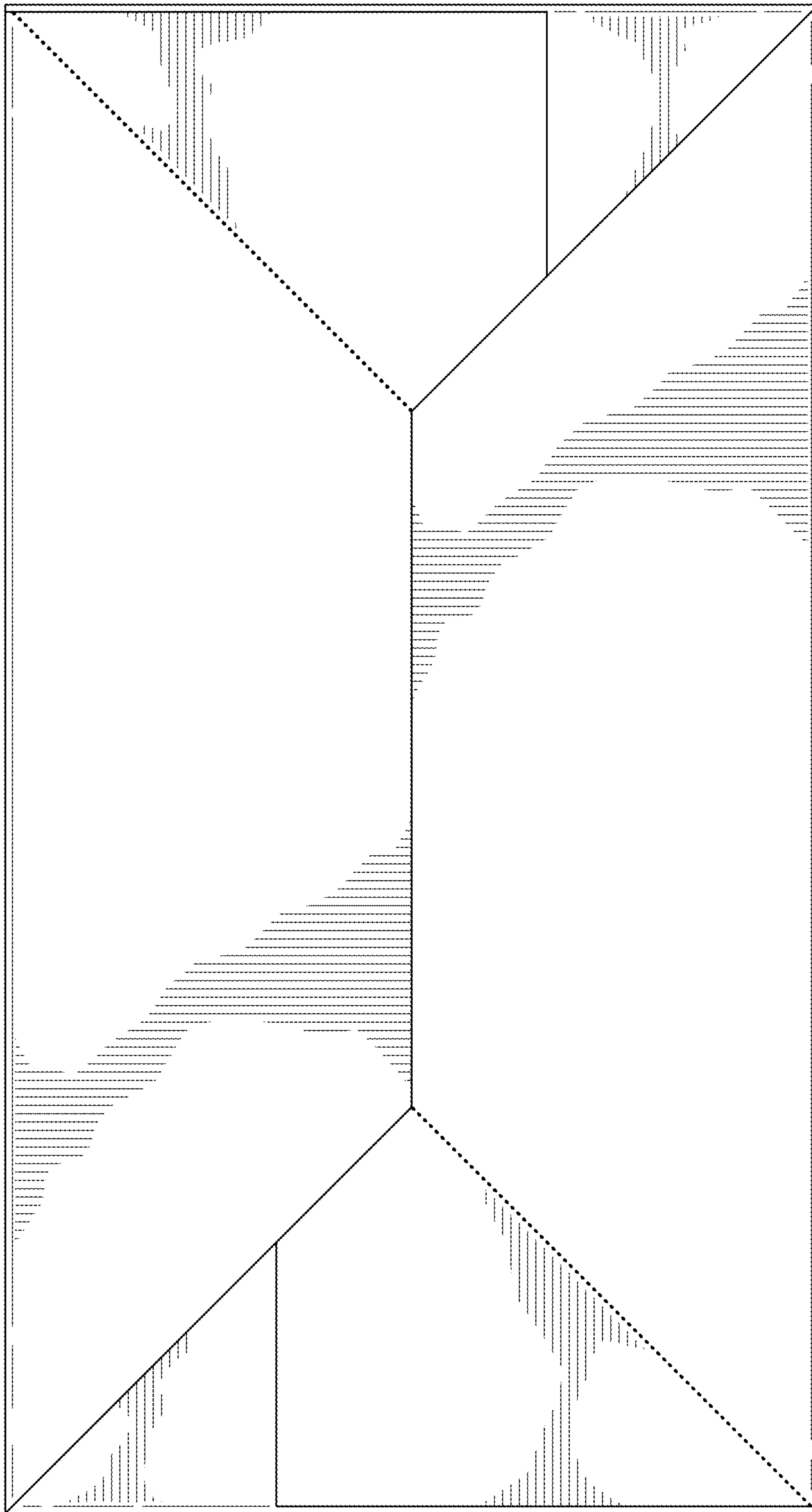

FIG. 25

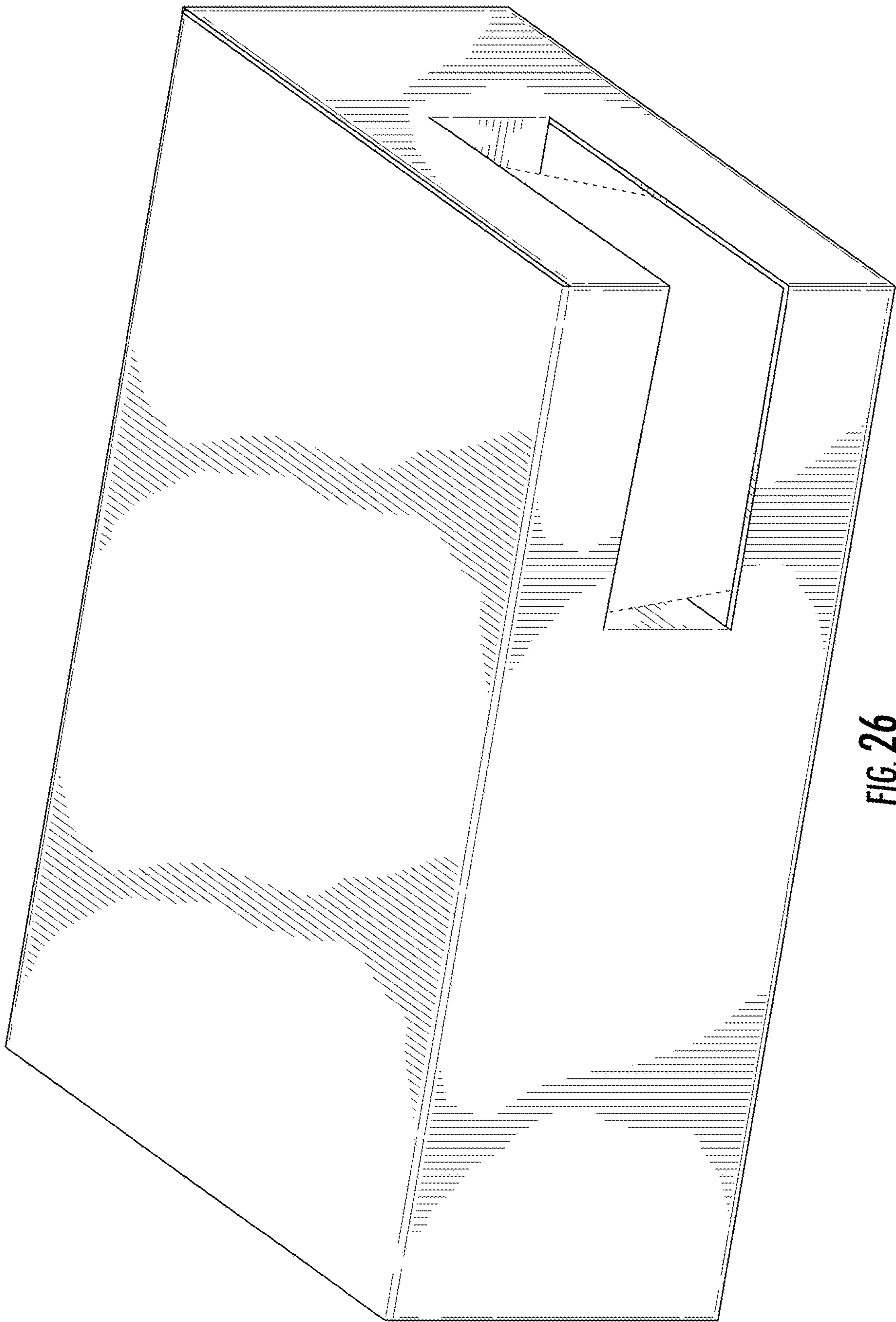

FIG. 26

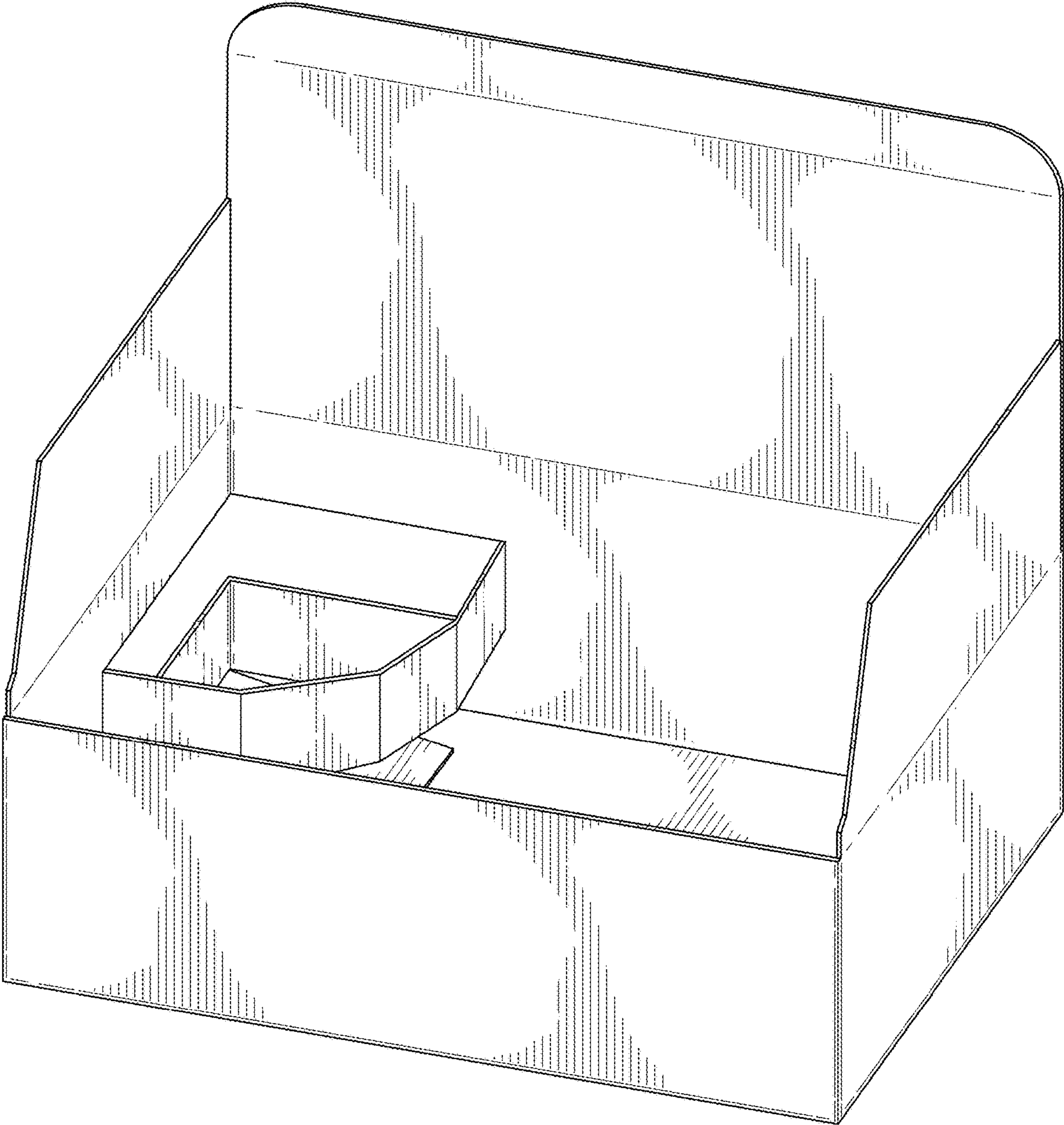

FIG. 27

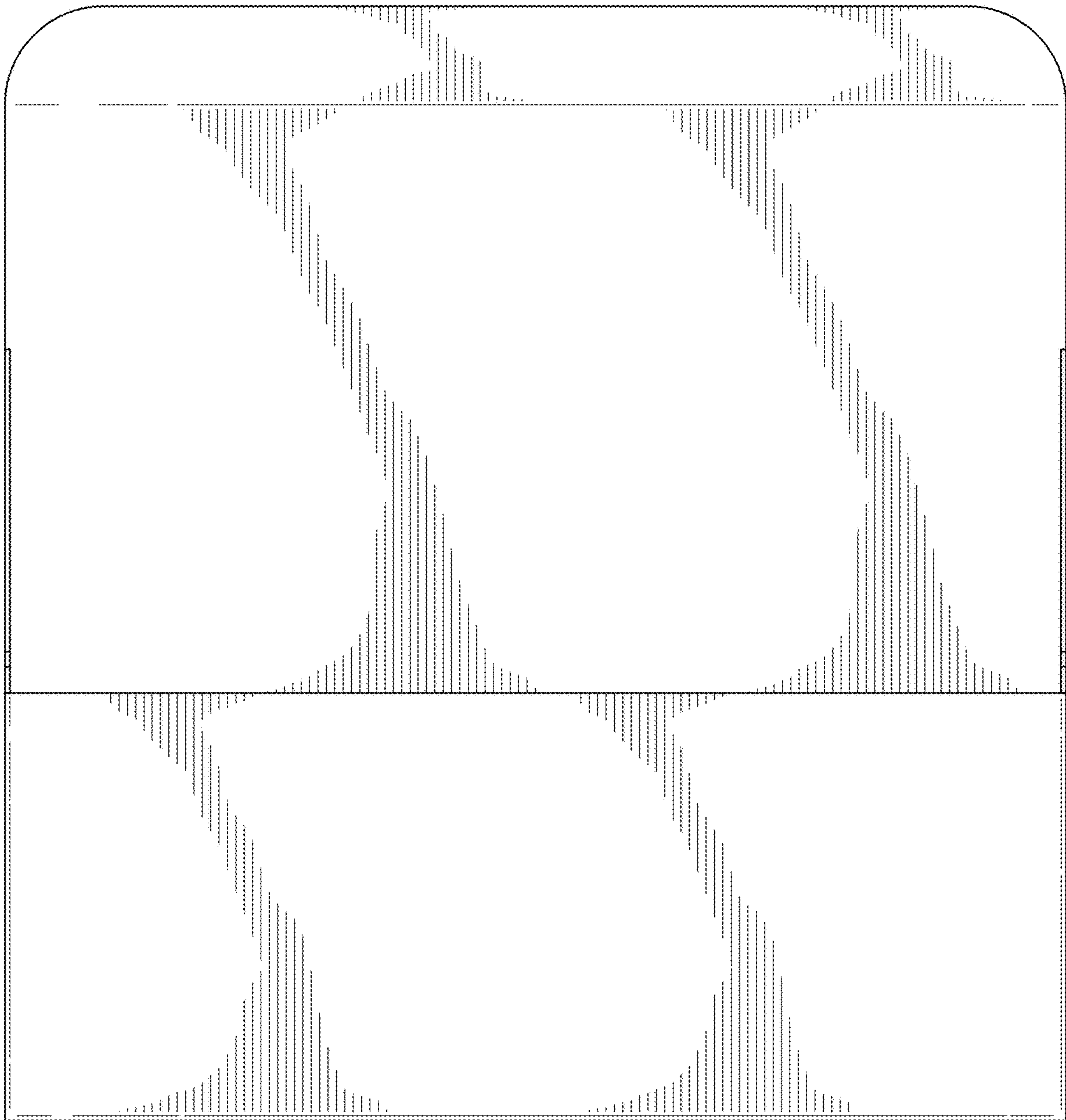

FIG. 28

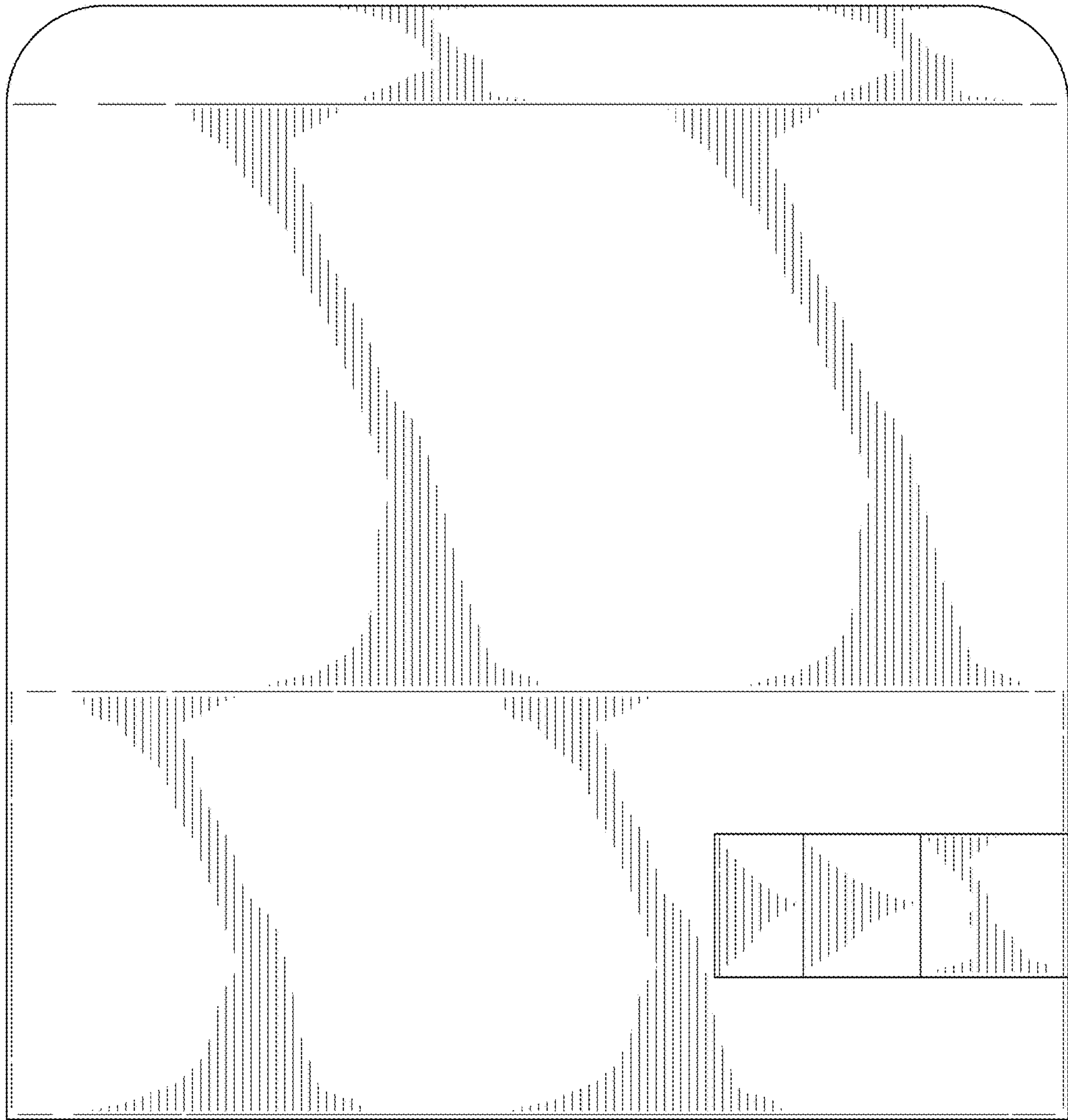

FIG. 29

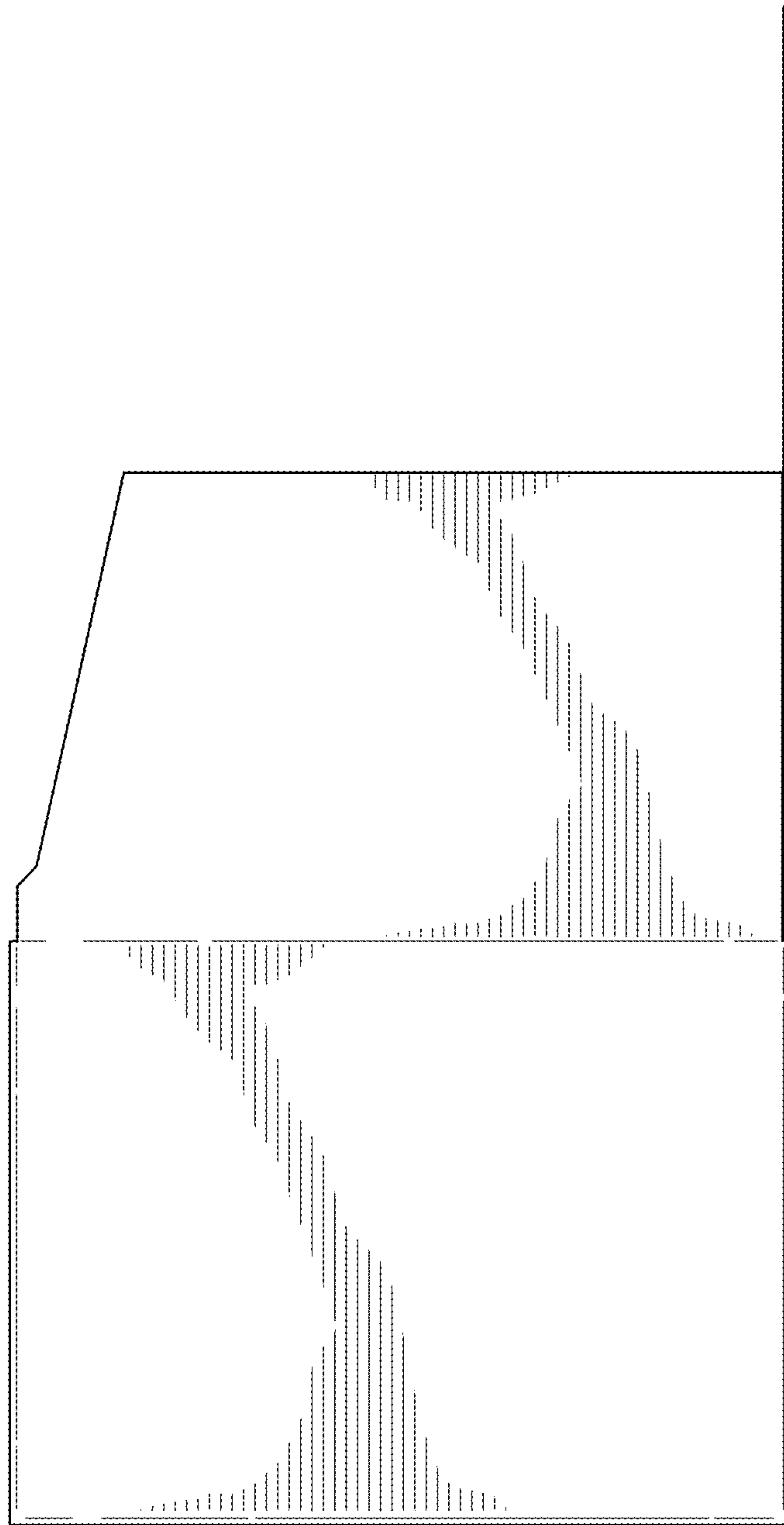

FIG. 30

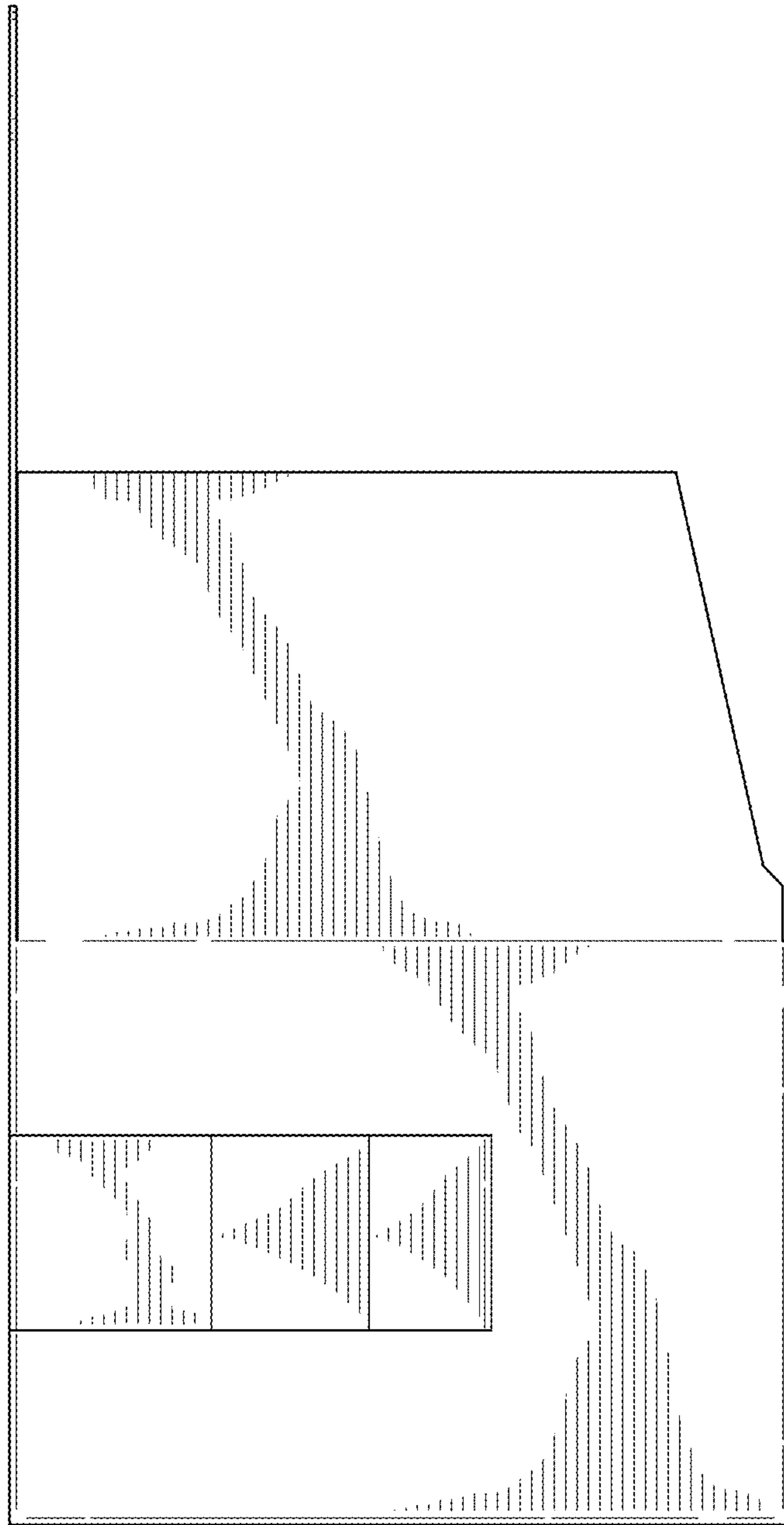

FIG. 31

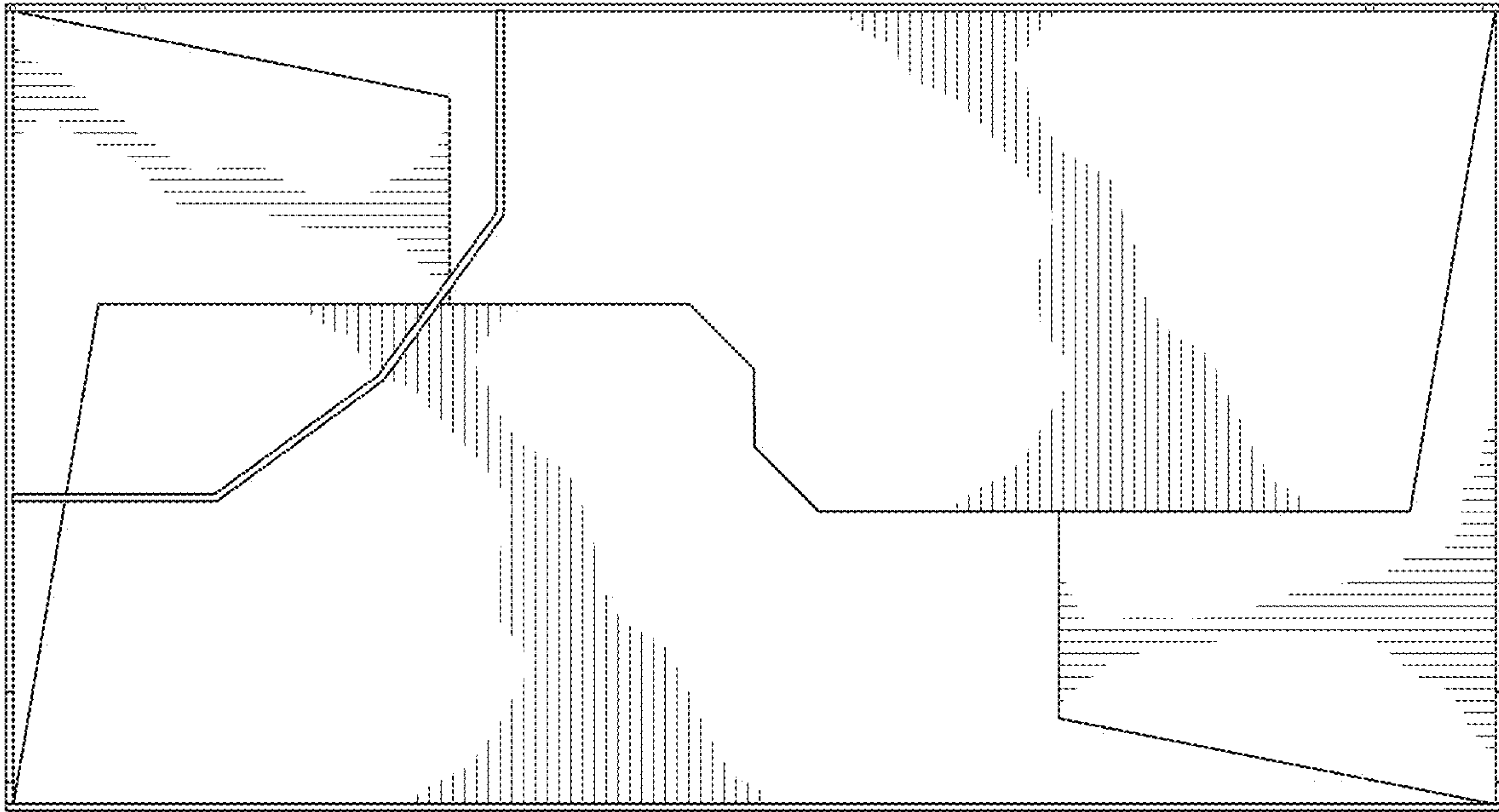

FIG. 32

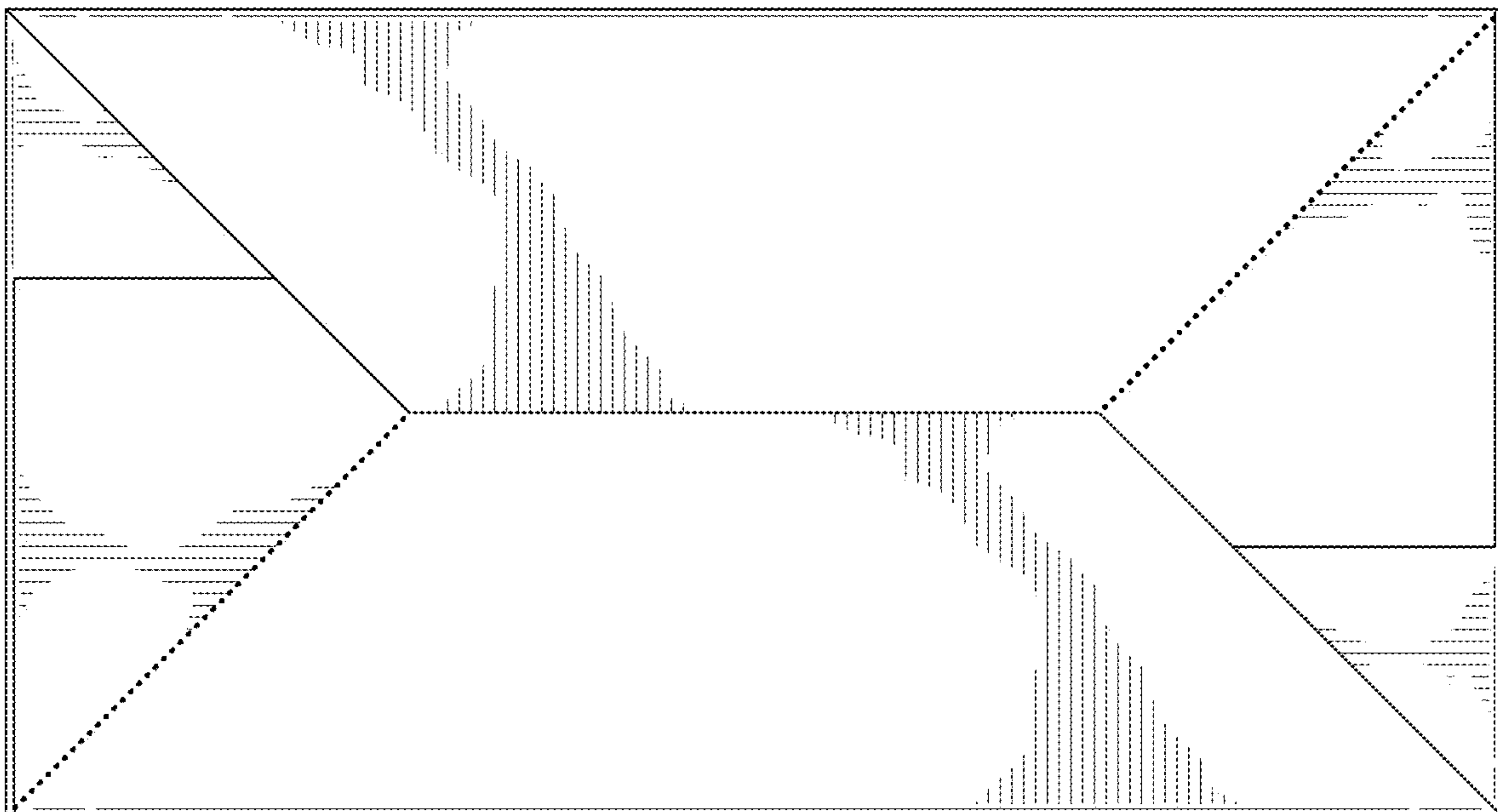

FIG. 33

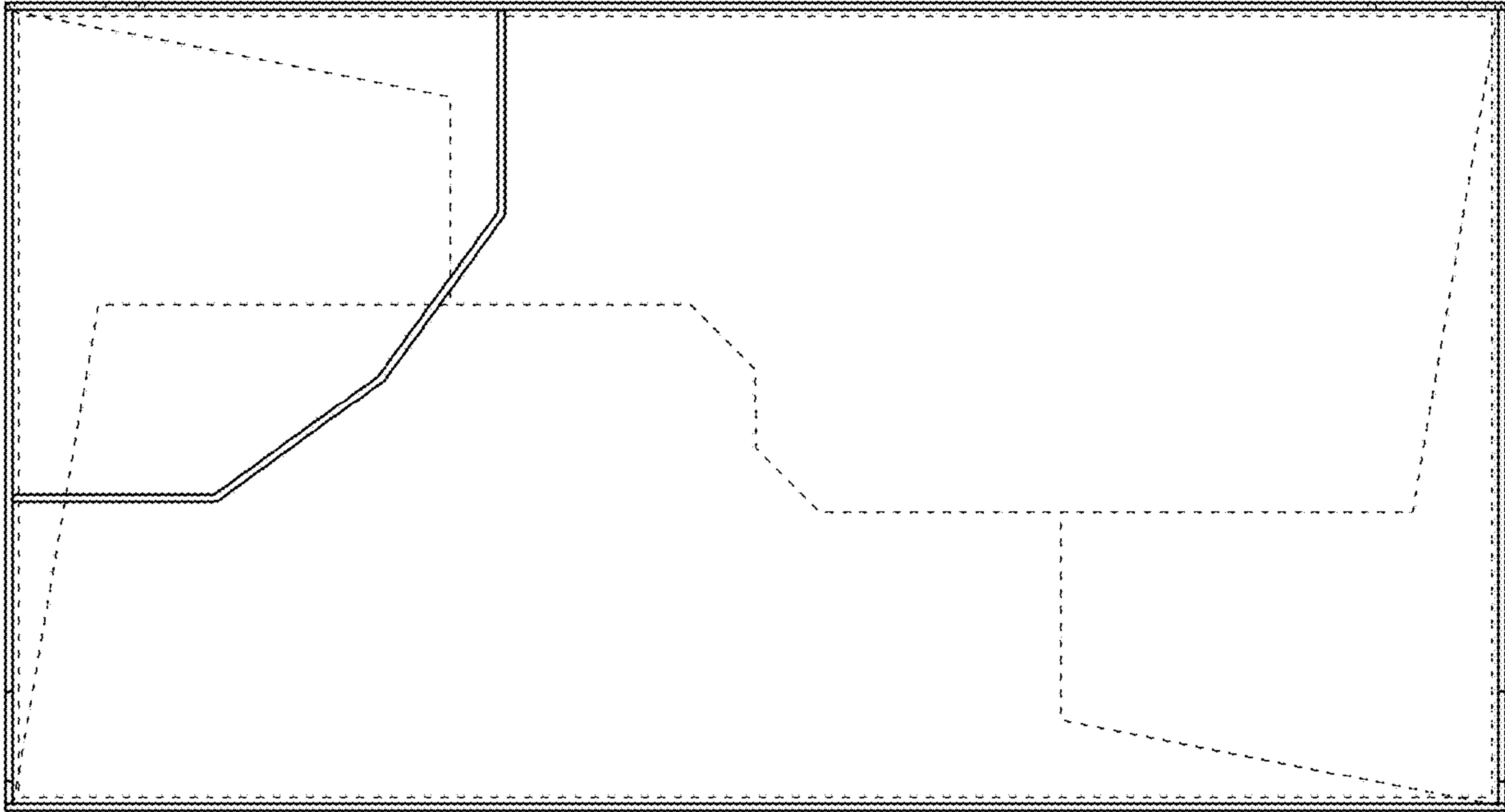

FIG. 34

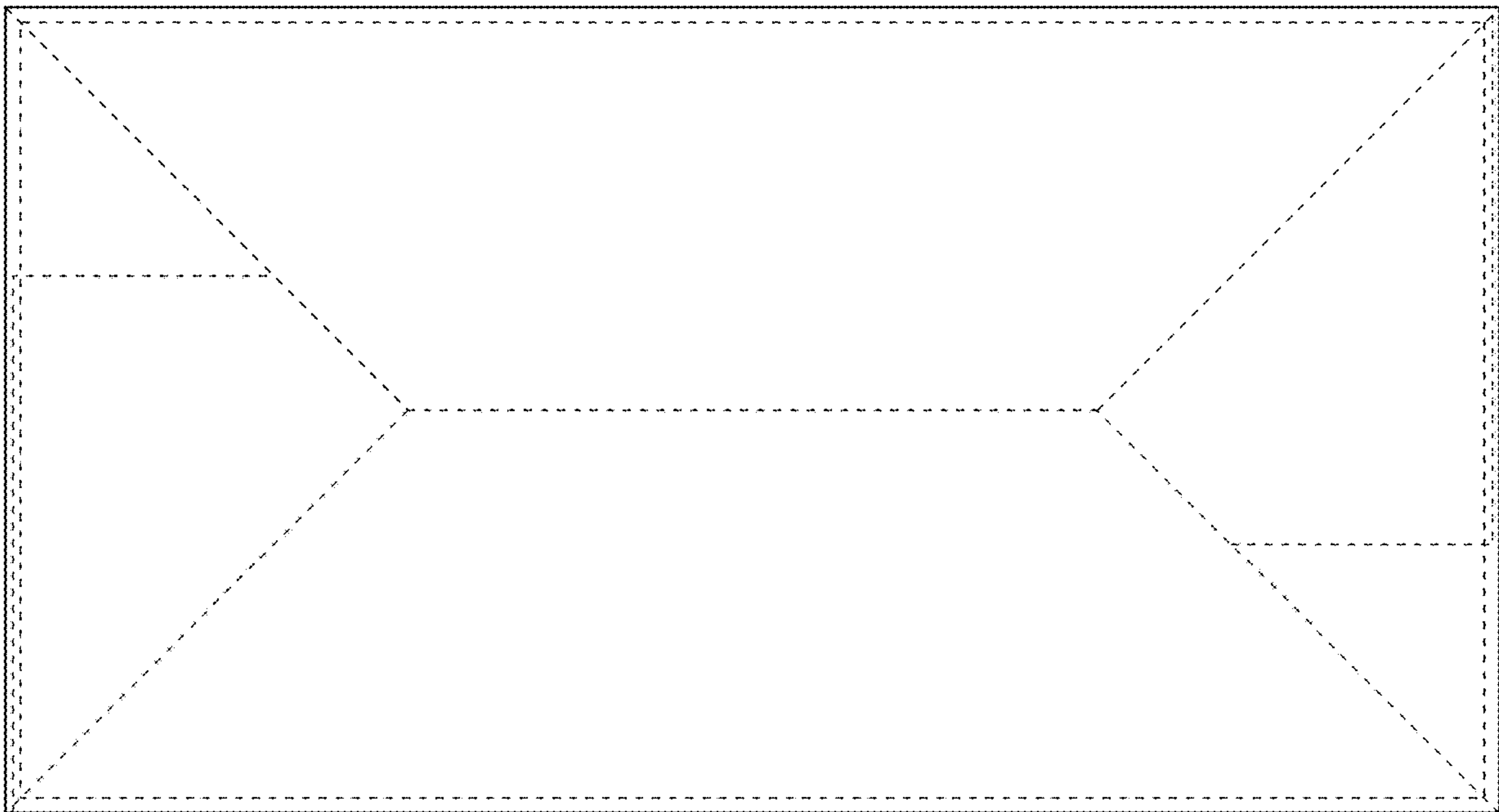

FIG. 35

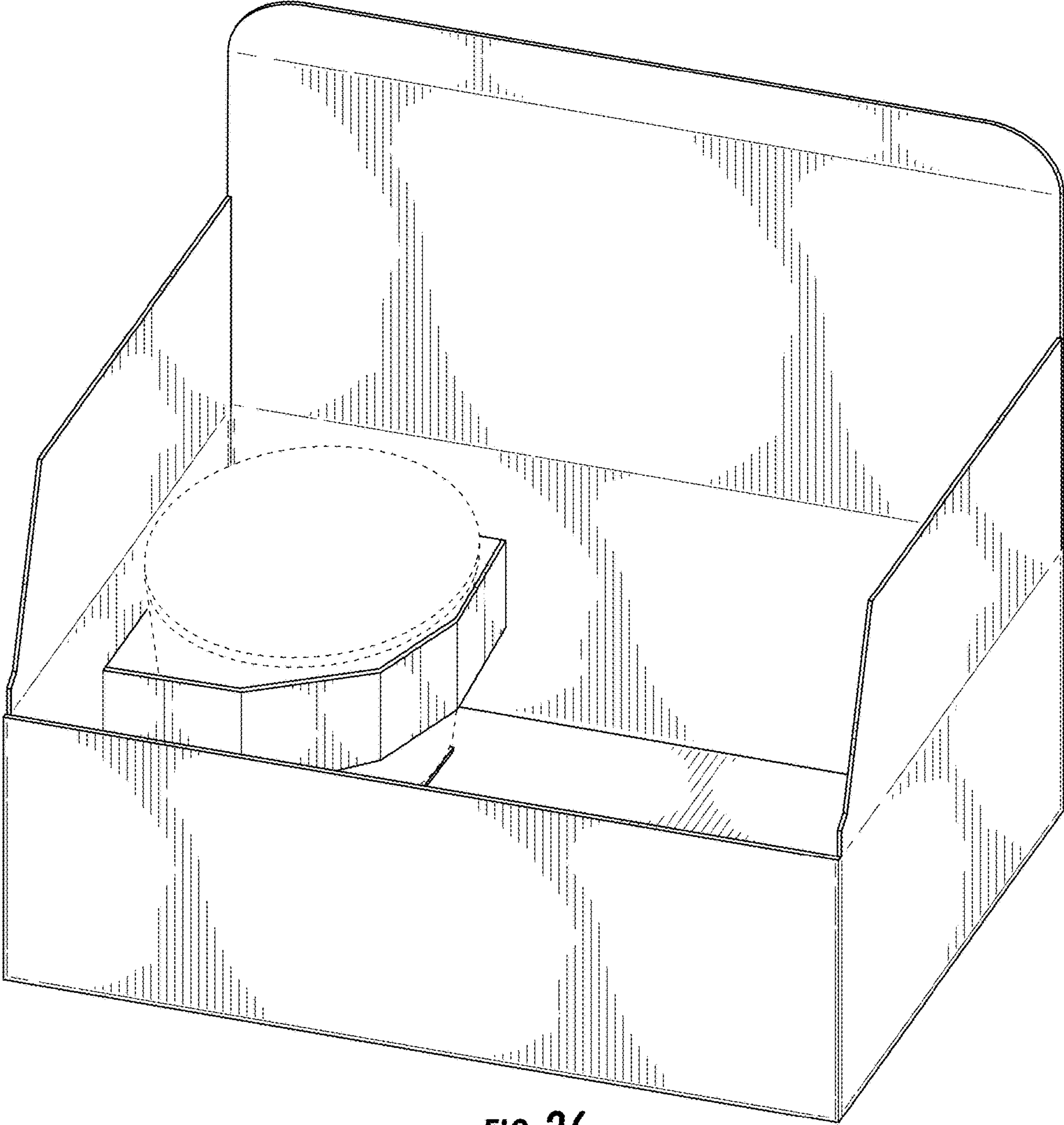

FIG. 36