



US00D891799S

(12) **United States Design Patent** (10) **Patent No.:** **US D891,799 S**  
**Wu** (45) **Date of Patent:** **\*\* Aug. 4, 2020**

(54) **CHAIR**  
(71) Applicant: **Dxracer Seat Manufacturing (Jiangsu) Co., Ltd., Wuxi (CN)**  
(72) Inventor: **Qing Wu, Wuxi (CN)**  
(\*\*) Term: **15 Years**  
(21) Appl. No.: **29/717,511**  
(22) Filed: **Dec. 18, 2019**  
(51) **LOC (12) Cl.** ..... **06-01**  
(52) **U.S. Cl.**  
USPC ..... **D6/359; D6/366**  
(58) **Field of Classification Search**  
USPC ..... D6/334-336, 359, 364, 365, 366, 367, D6/374, 379, 716, 716.1, 716.2, 716.4  
CPC ..... A47C 7/004; A47C 7/006; A47C 7/18; A47C 7/24; A47C 7/40; A47C 7/46; A47C 7/54; A63G 9/10  
See application file for complete search history.

D540,073 S 4/2007 McDiarmid et al.  
D597,331 S 8/2009 Neil  
D613,083 S \* 4/2010 Bassler ..... D6/359  
D696,055 S 12/2013 Pearson et al.  
D827,320 S \* 9/2018 Xue ..... D6/366  
D854,846 S \* 7/2019 Shen ..... D6/366  
D859,865 S \* 9/2019 Berlinches ..... D6/366  
D869,214 S \* 12/2019 Chen ..... D6/716

\* cited by examiner

*Primary Examiner* — Mimoso De  
(74) *Attorney, Agent, or Firm* — W&K IP

(57) **CLAIM**

The ornamental design for a chair, as shown and described.

**DESCRIPTION**

FIG. 1 is a perspective view of a chair; FIG. 2 is a front elevational view thereof; FIG. 3 is a rear elevational view thereof; FIG. 4 is a left elevational view thereof; FIG. 5 is a right elevational view thereof; FIG. 6 is a top plan view thereof; and, FIG. 7 is a bottom plan view thereof. The evenly broken lines where present illustrate portions of the chair that form no part of the claimed design.

**1 Claim, 7 Drawing Sheets**

(56) **References Cited**  
U.S. PATENT DOCUMENTS  
D336,789 S \* 6/1993 Yang ..... D6/359  
D347,756 S \* 6/1994 Robertson ..... D6/359  
D369,915 S \* 5/1996 Loader ..... D6/359  
D485,998 S \* 2/2004 Bourget ..... D6/359  
D490,991 S \* 6/2004 Desnos ..... D6/359

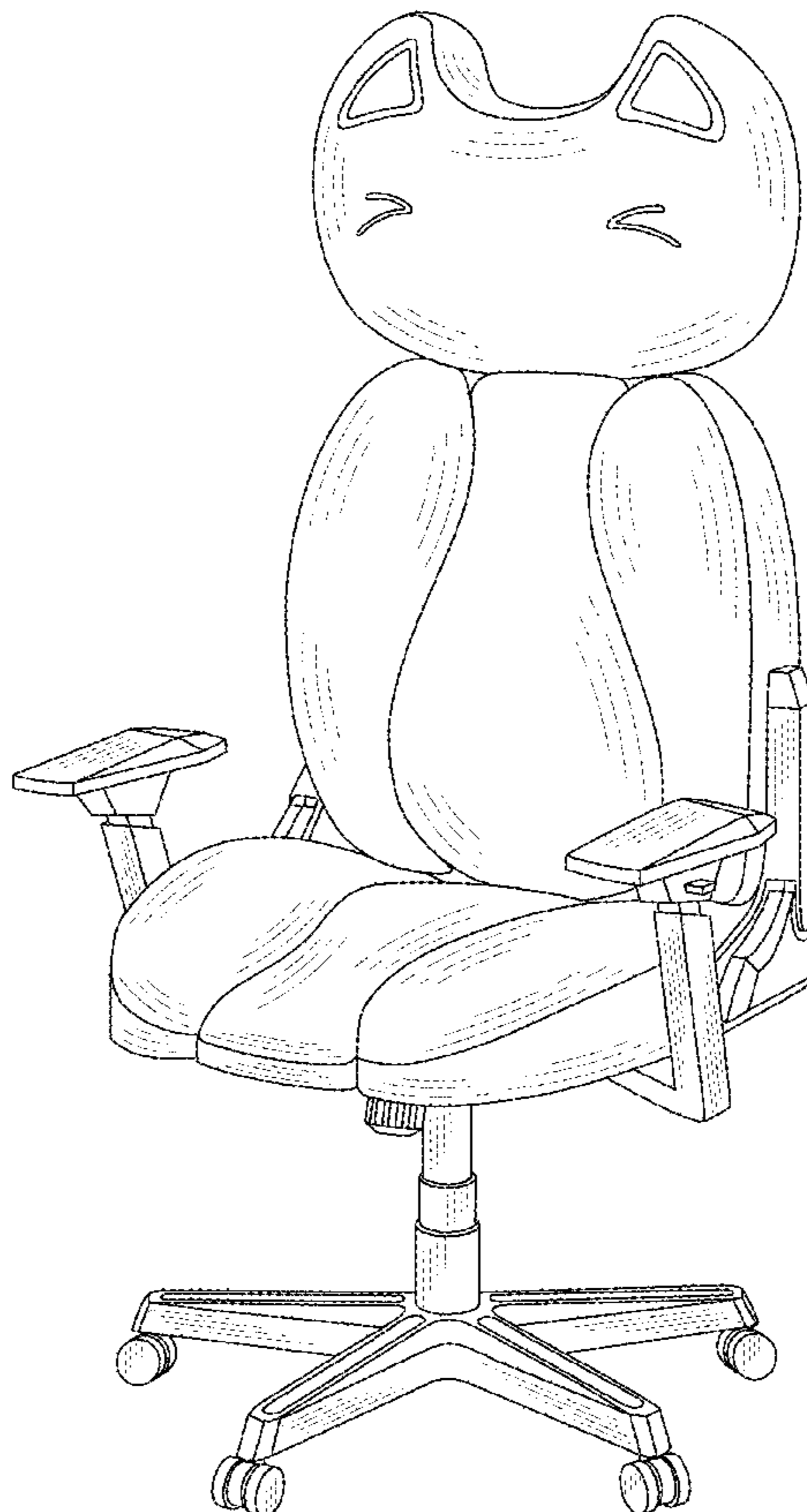

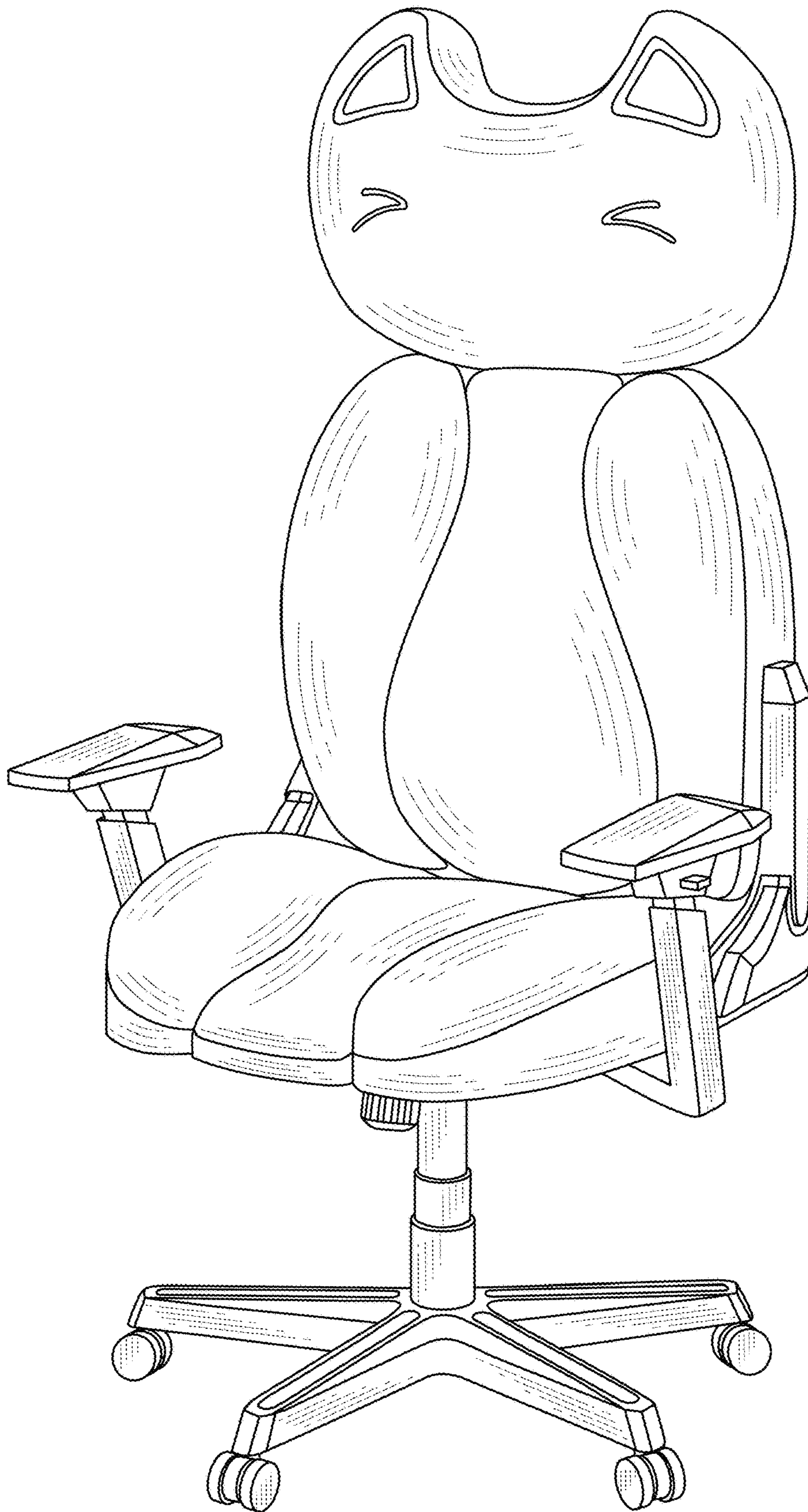

FIG. 1

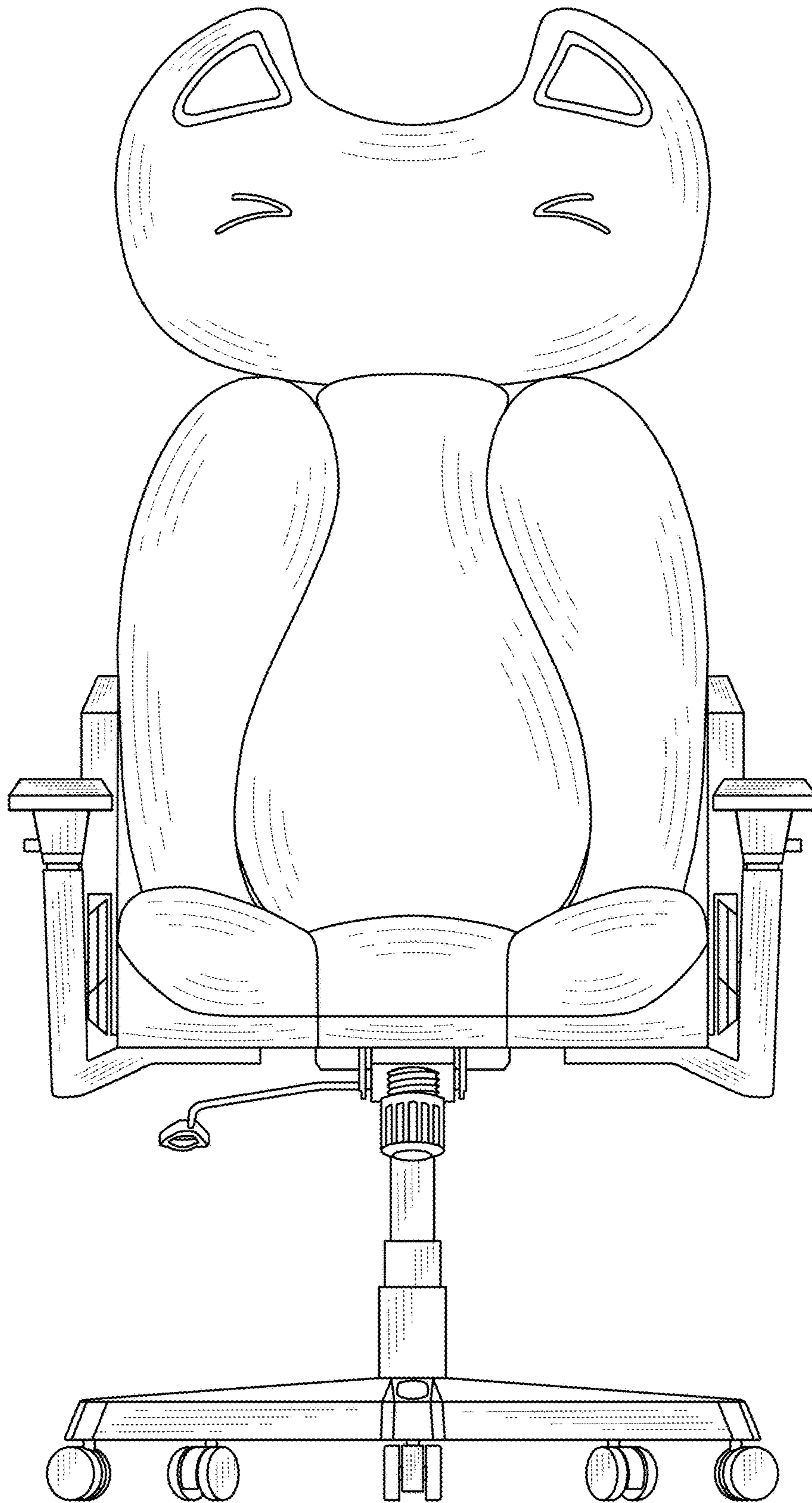

FIG.2

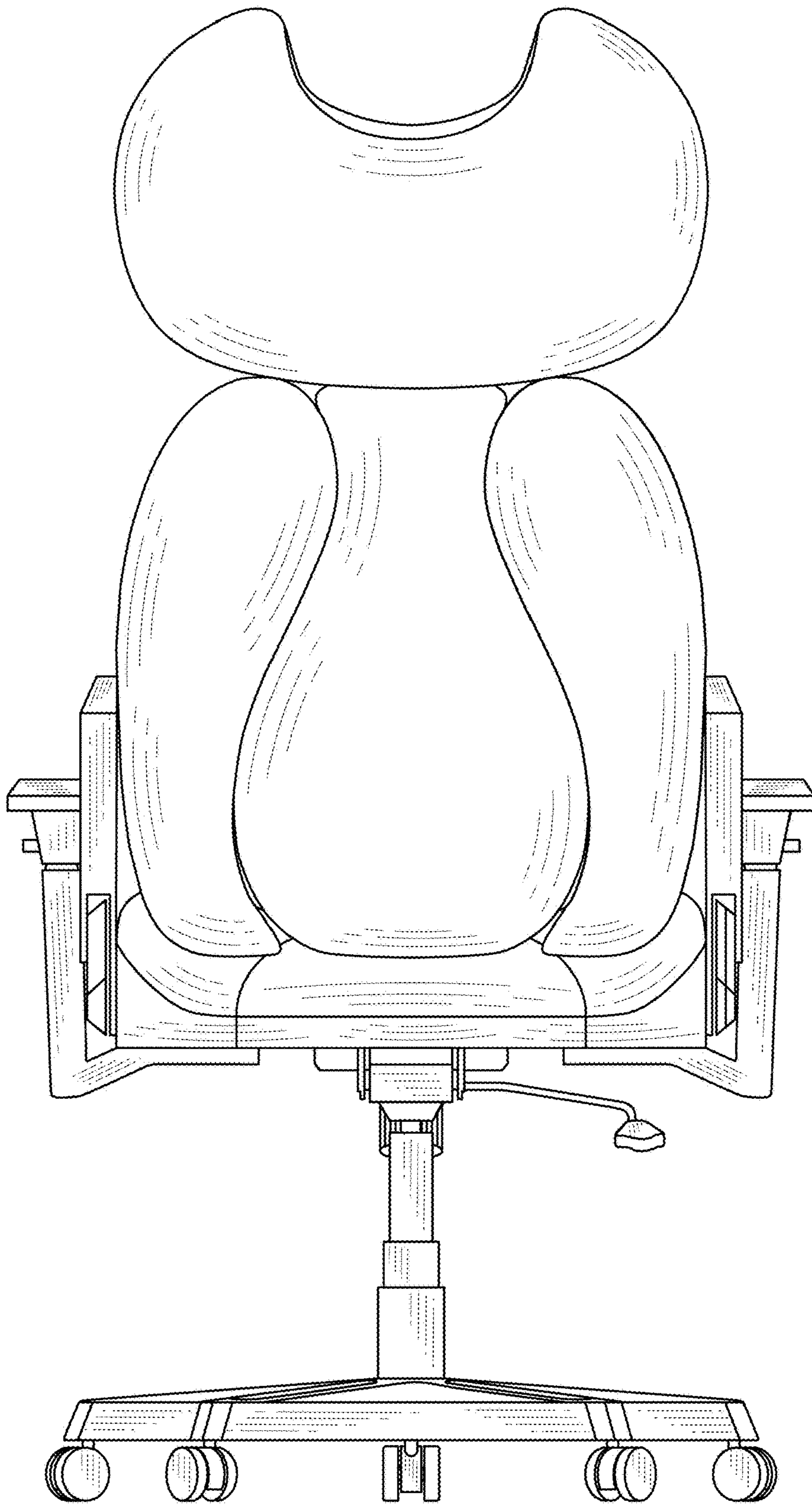

FIG.3

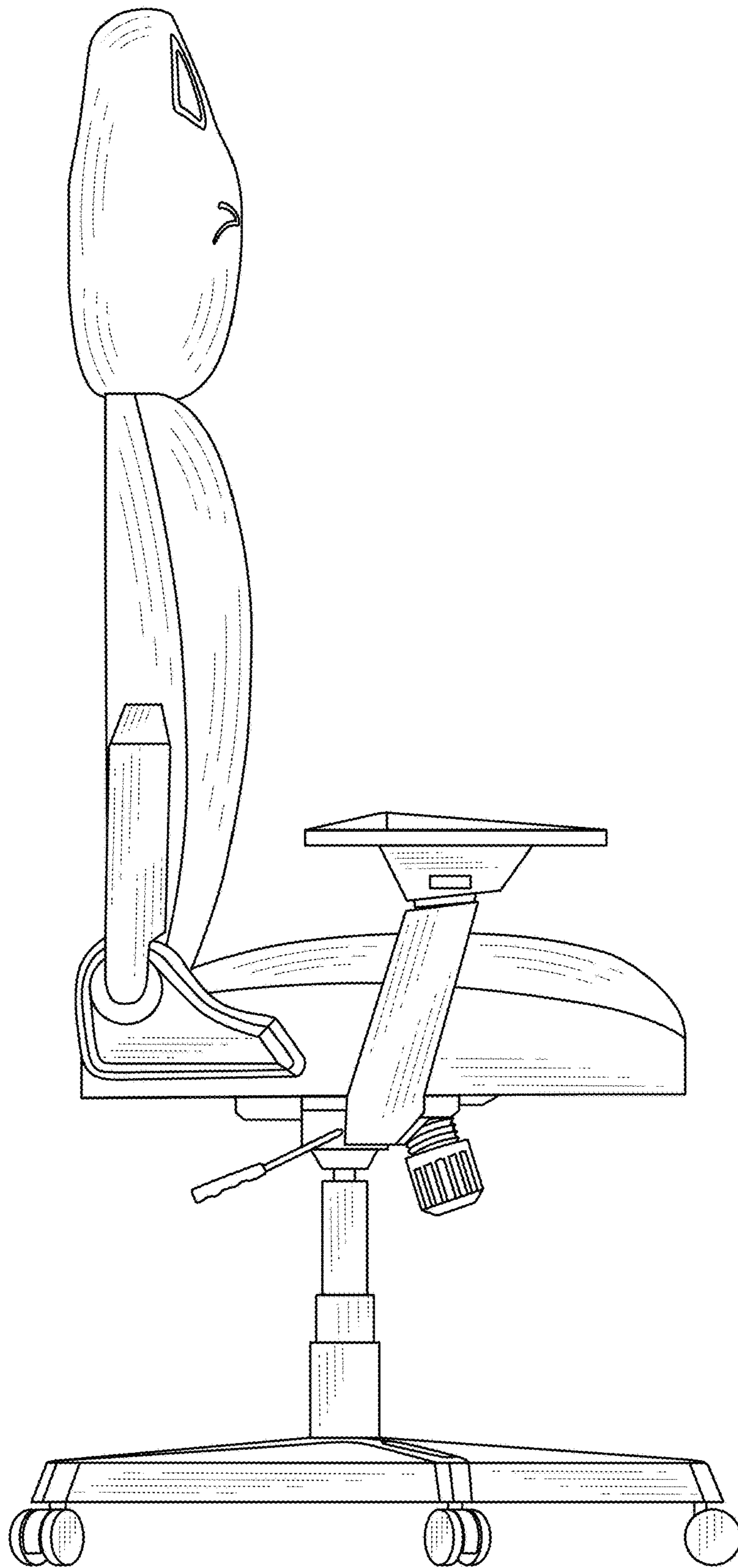

FIG.4

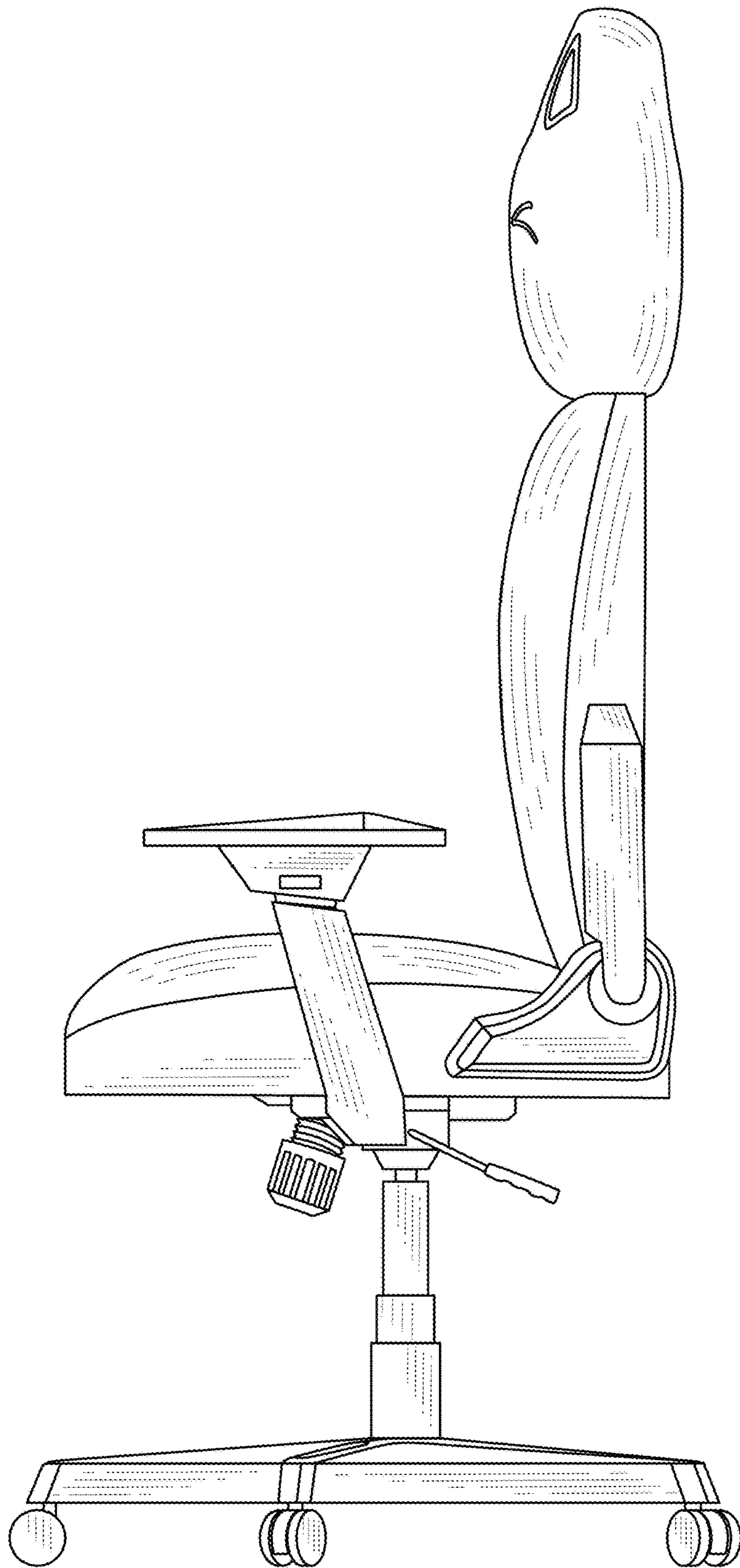

FIG.5

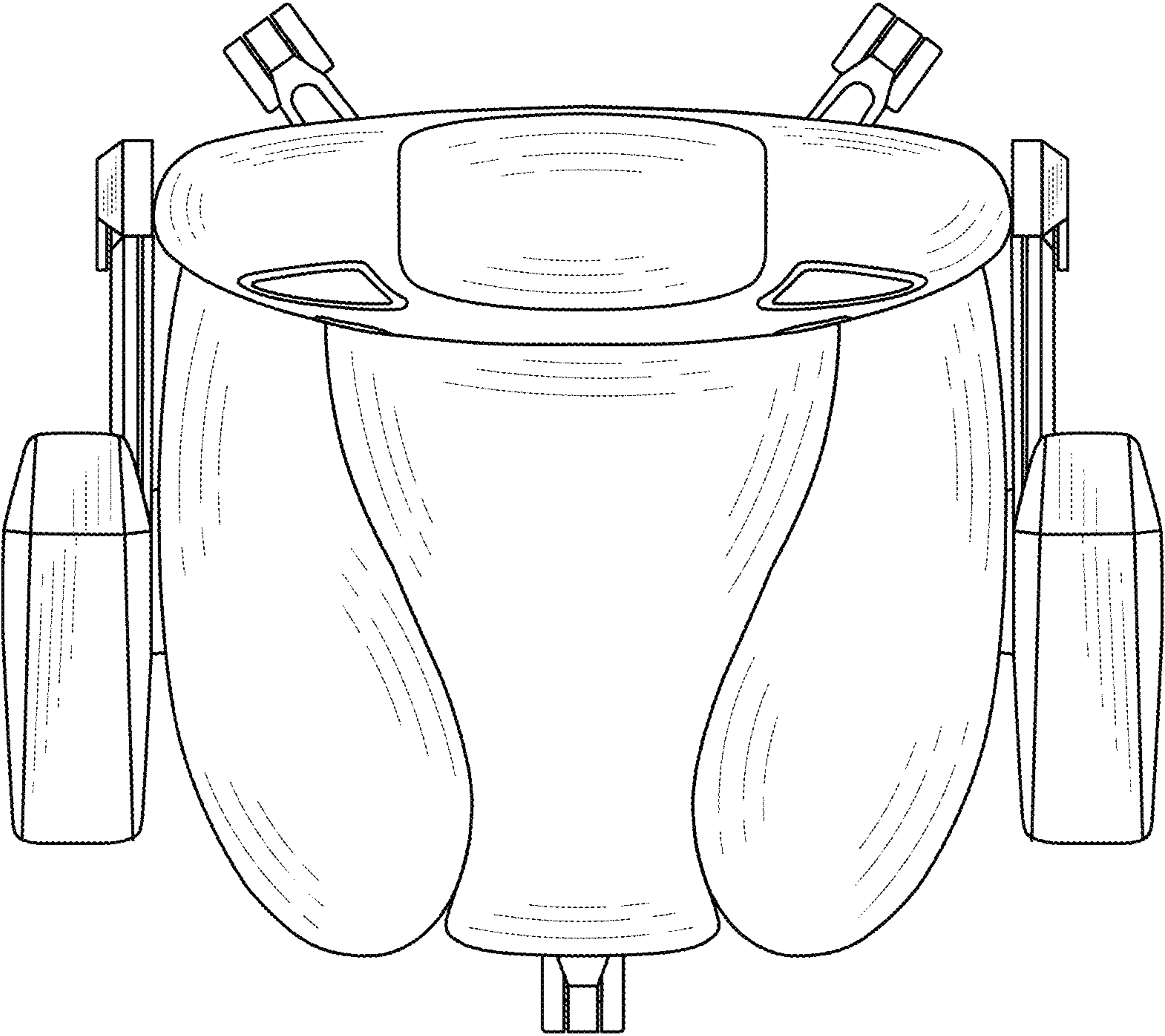

FIG.6

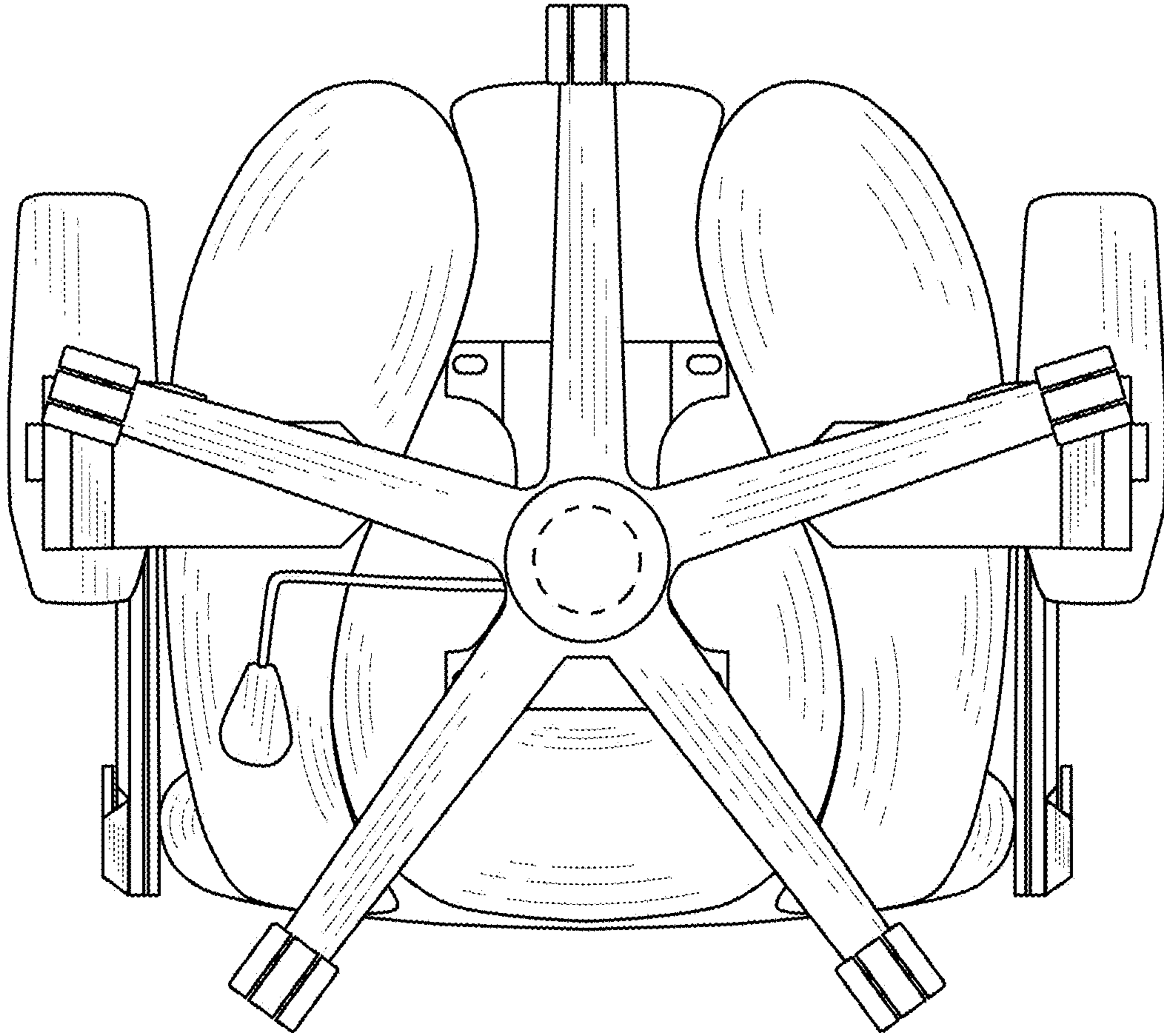

FIG. 7