



US00D891646S

(12) **United States Design Patent** (10) **Patent No.:** **US D891,646 S**
Bruhn et al. (45) **Date of Patent:** **** Jul. 28, 2020**

(54) **LIGHT ASSEMBLY**
(71) Applicant: **Vista Manufacturing Inc**, Elkhart, IN (US)
(72) Inventors: **Mitchell E. Bruhn**, Elkhart, IN (US); **Ian M. Frank**, Mishawaka, IN (US)
(73) Assignee: **Vista Manufacturing Inc**, Elkhart, IN (US)
(**) Term: **15 Years**
(21) Appl. No.: **29/654,926**
(22) Filed: **Jun. 28, 2018**
(51) **LOC (12) Cl.** **26-04**
(52) **U.S. Cl.**
USPC **D26/1**
(58) **Field of Classification Search**
USPC D26/1-4
CPC H01R 5/00; H01R 13/46; H01R 13/514; H01R 31/048; H01R 31/02; H01J 5/00; H01J 5/16; H01J 1/02; H01J 15/00; H01J 5/48; H01J 5/50; H01J 19/54; F21V 5/00; F21K 9/00; F21K 13/00
See application file for complete search history.

2008/0159694 A1 7/2008 Payne
2009/0073692 A1 3/2009 Berger et al.
2010/0201239 A1 8/2010 Mostoller et al.
2011/0176298 A1 7/2011 Meurer et al.
2012/0170258 A1 7/2012 VanDuinen et al.
2012/0250301 A1 10/2012 Tung et al.

FOREIGN PATENT DOCUMENTS

WO 2011110217 A1 9/2011

OTHER PUBLICATIONS

Photo of Welt-lite product sold by Vista Manufacturing Inc., at least as early as Jun. 27, 2017.

* cited by examiner

Primary Examiner — Marcus A Jackson
(74) *Attorney, Agent, or Firm* — Warner Norcross + Judd LLP

(57) **CLAIM**

The ornamental design for the light assembly, as shown and described.

DESCRIPTION

FIG. 1 is a perspective view of a light assembly, with the center portion broken away to indicate indeterminate length; FIG. 2 is a left side elevation view thereof, which is a mirror image of the right side elevation view; FIG. 3 is a top plan view thereof; FIG. 4 is a bottom plan view thereof; FIG. 5 is a front elevation view thereof; and, FIG. 6 is a rear elevation view thereof. The broken lines represent portions of the structure that forms no part of the claimed design.

1 Claim, 3 Drawing Sheets

(56) **References Cited**
U.S. PATENT DOCUMENTS
D528,672 S * 9/2006 Nagai D26/1
D535,037 S * 1/2007 Kim D26/1
7,253,444 B2 8/2007 Ikeda
D594,576 S * 6/2009 Chan D26/1
8,322,833 B2 12/2012 Cleaver et al.
8,366,291 B2 2/2013 Hoffmann
9,695,991 B2 7/2017 Camarota
9,909,719 B2 3/2018 Camarota
2005/0231947 A1 10/2005 Sloan et al.
2008/0007945 A1 1/2008 Kelly et al.

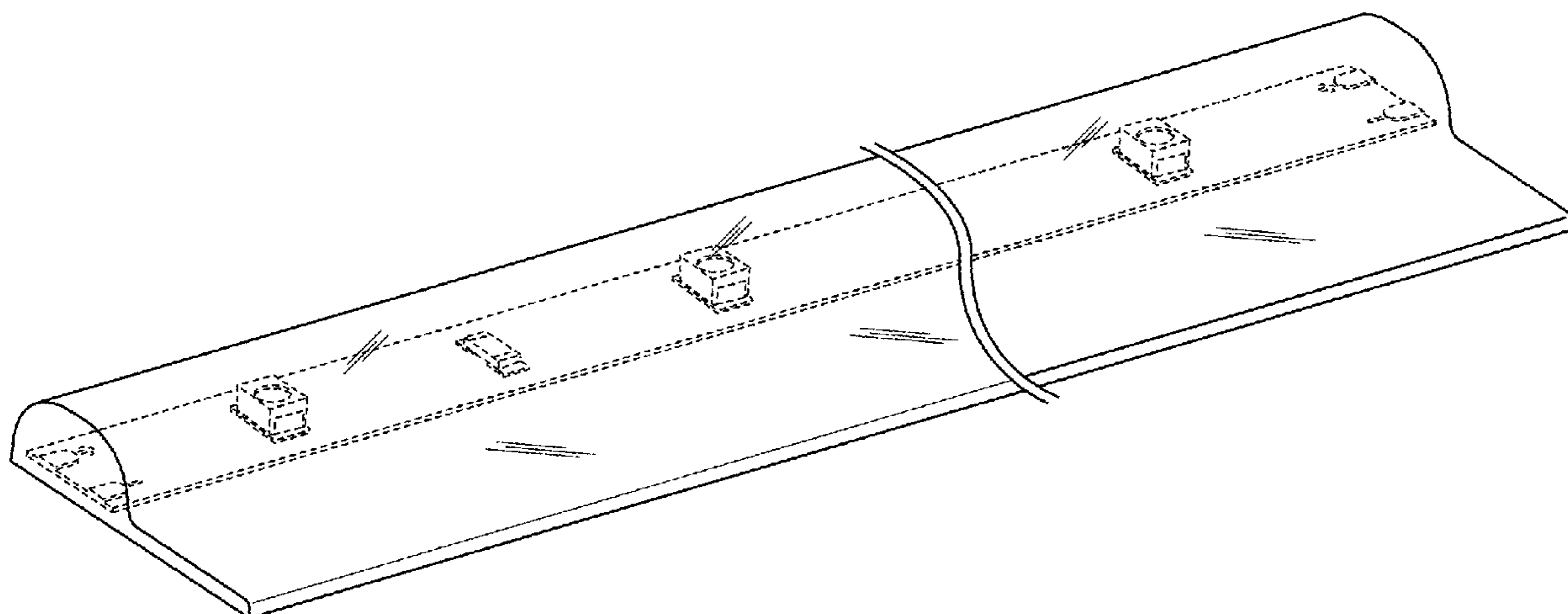

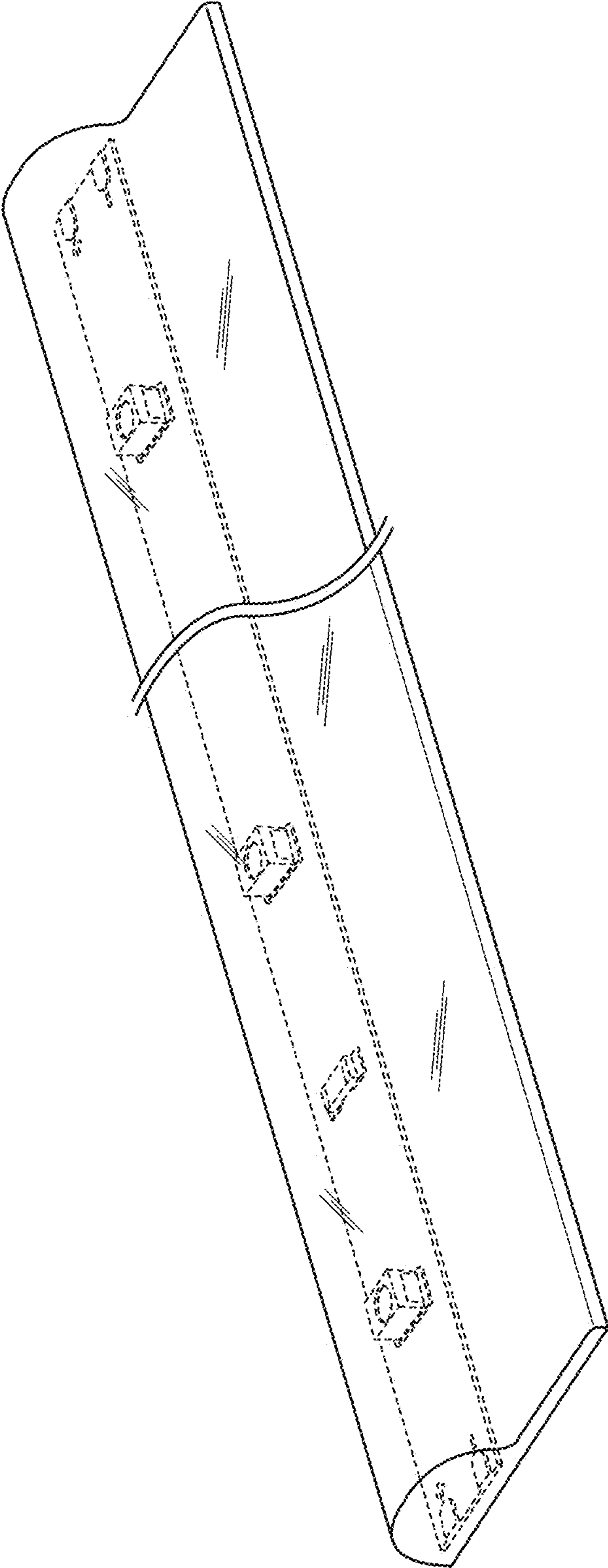
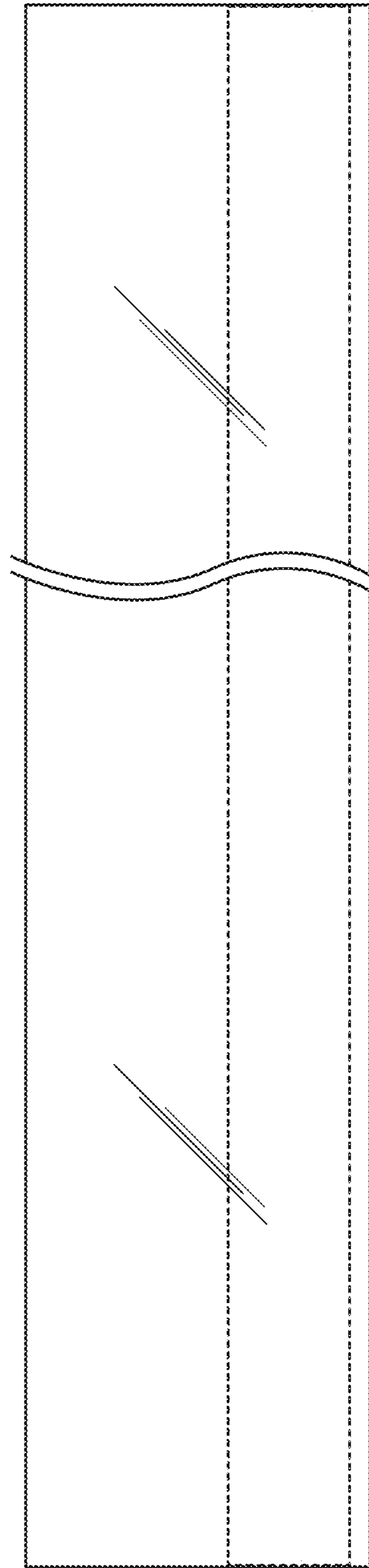
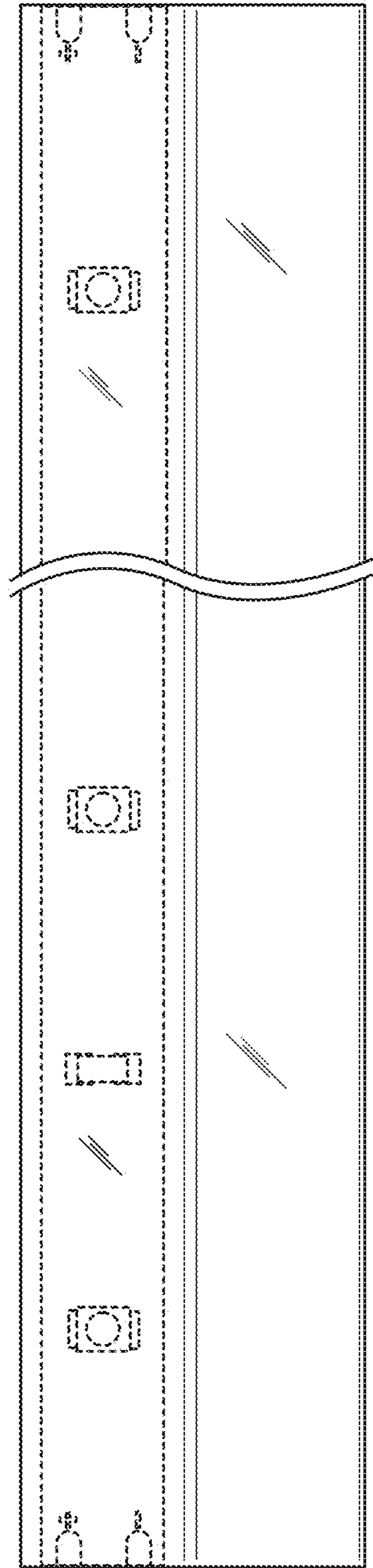
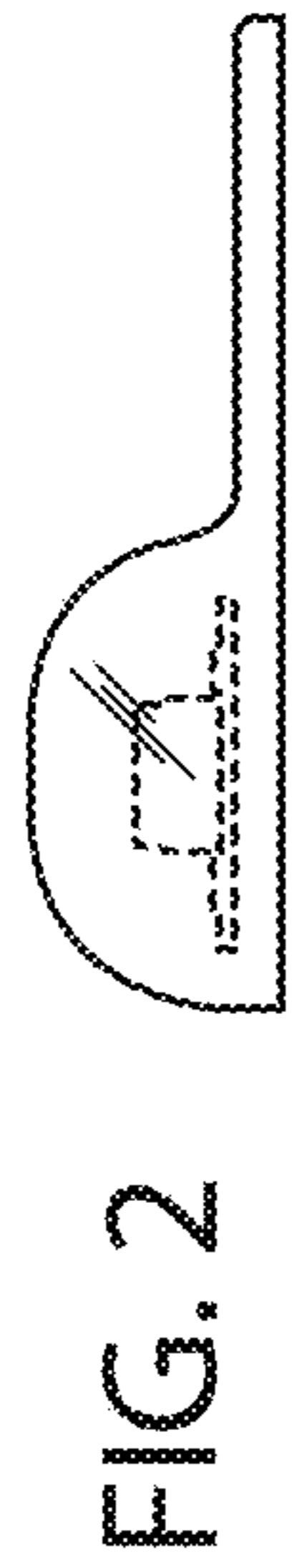

FIG. 1



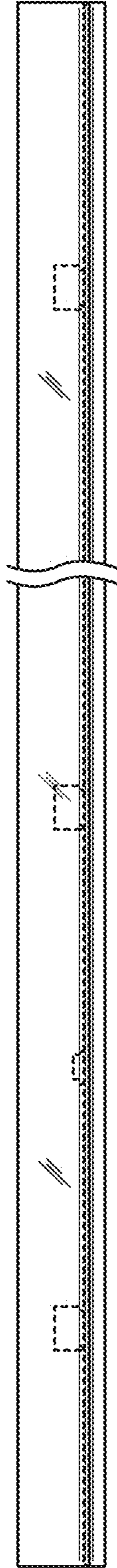

FIG. 5



FIG. 6