



US00D891638S

(12) **United States Design Patent**  
**Rochlitzer**

(10) **Patent No.:** **US D891,638 S**

(45) **Date of Patent:** **\*\* Jul. 28, 2020**

(54) **PORTABLE HOUSING**  
(71) Applicant: **Cynthia Rochlitzer**, Spokane, WA (US)  
(72) Inventor: **Cynthia Rochlitzer**, Spokane, WA (US)  
(\*\*) Term: **15 Years**

3,716,267 A \* 2/1973 Lindsay ..... B60P 3/32  
296/168  
3,877,187 A \* 4/1975 Livingston ..... B60P 3/32  
52/143  
D243,596 S \* 3/1977 Ksenych ..... D12/102  
D295,734 S \* 5/1988 Barber ..... D12/103  
D320,051 S \* 9/1991 Phillips ..... D12/103  
D343,146 S \* 1/1994 Premo ..... D12/103

(Continued)

(21) Appl. No.: **29/572,463**

(22) Filed: **Jul. 28, 2016**

(51) **LOC (12) Cl.** ..... **25-03**

(52) **U.S. Cl.**  
USPC ..... **D25/35**

(58) **Field of Classification Search**  
USPC ..... D12/101, 102, 103, 413, 414.1; D25/1,  
D25/3, 32, 33, 35  
CPC ... E04B 1/16; E04B 1/165; E04B 1/24; E04B  
1/348; E04B 1/3483; E04B 1/34869;  
E04B 2001/2472; E04B 2001/2484; E04B  
2001/2496; B60P 3/32; B60P 3/36; B60P  
3/38; B60P 3/39  
See application file for complete search history.

FOREIGN PATENT DOCUMENTS

KR 300495642.0000 \* 6/2008  
KR 3020140001280 \* 12/2014

OTHER PUBLICATIONS

Mobitatu Twitter <https://twitter.com/mobitatu> Posted Jan. 3, 2019  
(Year: 2019).\*

(Continued)

*Primary Examiner* — Leanne Was-Englehart  
(74) *Attorney, Agent, or Firm* — Furr Law Firm; Jeffrey  
Furr

(56) **References Cited**

U.S. PATENT DOCUMENTS

2,154,142 A \* 4/1939 Whelan ..... E03C 1/01  
52/79.3  
D176,166 S \* 11/1955 Wait et al. .... D12/104  
3,166,870 A \* 1/1965 La Porte ..... B60P 3/343  
52/90.1  
D216,010 S \* 11/1969 Hudson ..... D12/104  
D216,109 S \* 11/1969 Kirk ..... D12/103  
3,492,767 A \* 2/1970 Pincus ..... E04B 1/34869  
52/79.1  
3,514,910 A \* 6/1970 Comm ..... E04B 1/34807  
52/79.11  
3,605,350 A \* 9/1971 Bowers ..... E04B 1/24  
52/16  
D222,342 S \* 10/1971 Glisson ..... D25/18  
D225,519 S \* 12/1972 Glisson ..... D25/18  
D226,074 S \* 1/1973 Glisson ..... D25/18

(57) **CLAIM**

The ornamental design for a portable housing, as shown and  
described.

**DESCRIPTION**

FIG. 1 is a front view of the portable housing showing our  
new design thereof;  
FIG. 2 is a back side view thereof;  
FIG. 3 is a bottom view thereof;  
FIG. 4 is a left side view thereof;  
FIG. 5 is the right side view thereof; and,  
FIG. 6 is a top plan view of the interior view thereof.  
The broken lines depict portions of the portable housing that  
form no part of the claimed design.

**1 Claim, 6 Drawing Sheets**

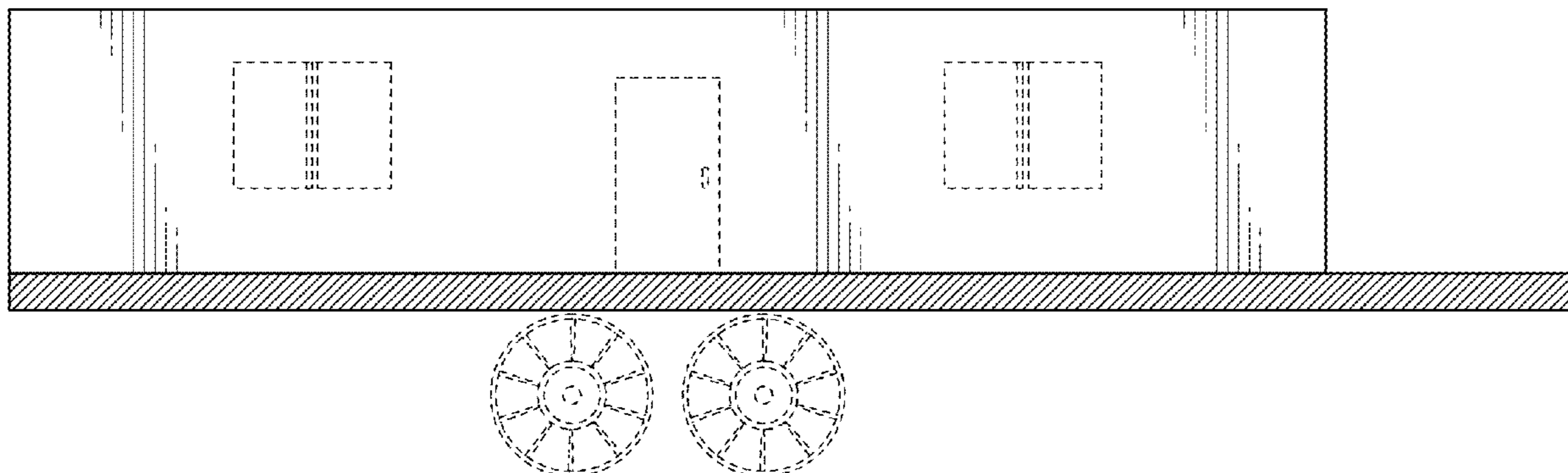

(56)

References Cited

U.S. PATENT DOCUMENTS

5,383,703 A \* 1/1995 Irvine, III ..... B60P 3/36  
 296/24.45  
 D372,538 S \* 8/1996 Del Monte ..... D25/35  
 D372,789 S \* 8/1996 DelMonte ..... D25/35  
 D450,133 S \* 11/2001 White ..... D25/35  
 D534,099 S \* 12/2006 Prusmack ..... D12/101  
 D544,815 S \* 6/2007 Williams ..... D12/101  
 D561,063 S \* 2/2008 Hughes ..... D12/102  
 D561,648 S \* 2/2008 Shelton ..... D12/101  
 D694,428 S \* 11/2013 Eckert ..... D25/35  
 8,650,806 B1 \* 2/2014 Condie ..... E04H 1/1205  
 52/79.5  
 8,876,148 B2 \* 11/2014 Sartini ..... B60G 9/00  
 280/656  
 D727,531 S \* 4/2015 Gill ..... D25/22  
 9,068,340 B2 \* 6/2015 Austin ..... E04B 1/348  
 D739,556 S \* 9/2015 Yoder ..... D25/33  
 D763,465 S \* 8/2016 Bakshi ..... D25/33  
 D781,442 S \* 3/2017 Gill ..... D25/32  
 D781,443 S \* 3/2017 Gill ..... D25/32  
 D781,444 S \* 3/2017 Gill ..... D25/32  
 D812,249 S \* 3/2018 Jimenez Rivera ..... D25/32  
 D836,037 S \* 12/2018 Tran ..... D12/102  
 D845,508 S \* 4/2019 Gill ..... D25/33  
 D850,650 S \* 6/2019 Gill ..... D25/33

D852,377 S \* 6/2019 Gill ..... D25/33  
 2009/0223143 A1 \* 9/2009 Esposito ..... E04B 1/34869  
 52/79.1  
 2010/0066070 A1 \* 3/2010 Scott-Greavu ..... B60P 3/32  
 280/789  
 2011/0041415 A1 \* 2/2011 Esposito ..... E04B 1/34331  
 52/12  
 2011/0162293 A1 \* 7/2011 Levy ..... E04B 1/3483  
 52/79.9  
 2011/0296789 A1 \* 12/2011 Collins ..... E04B 1/24  
 52/741.4  
 2017/0370116 A1 \* 12/2017 Cincotta ..... E04H 1/1205  
 2018/0230690 A1 \* 8/2018 Leibinger ..... E04H 3/08  
 2018/0370338 A1 \* 12/2018 Bacon ..... B60J 1/2088  
 2019/0009337 A1 \* 1/2019 Nicaise ..... B29C 64/25  
 2019/0217929 A1 \* 7/2019 Lefevre ..... E04B 1/34815  
 2019/0263314 A1 \* 8/2019 Harada ..... E04B 1/003

OTHER PUBLICATIONS

Mobitat Portable Housing Units <http://mobitatportablehousing.com/>  
 Available Aug. 6, 2016 (Year: 2016).\*  
 Mobile Offices Design Space Modular Buildings Inc <https://designspacemodular.com/mobile-offices-pictures/> Available Apr. 15,  
 2016 (Year: 2016).\*

\* cited by examiner

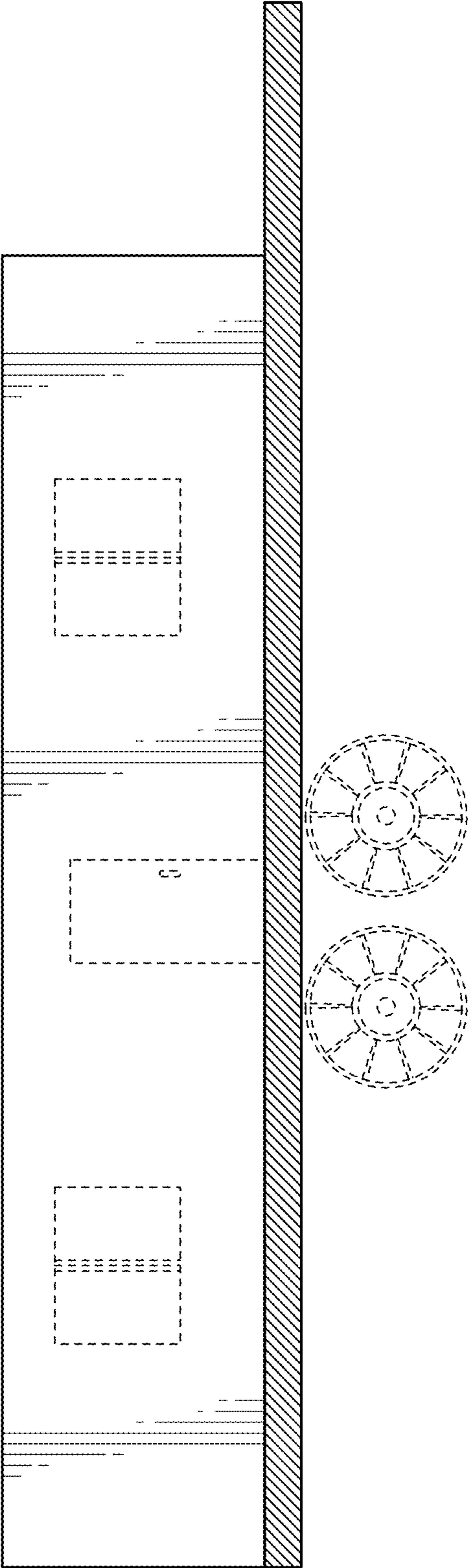

FIG. 1

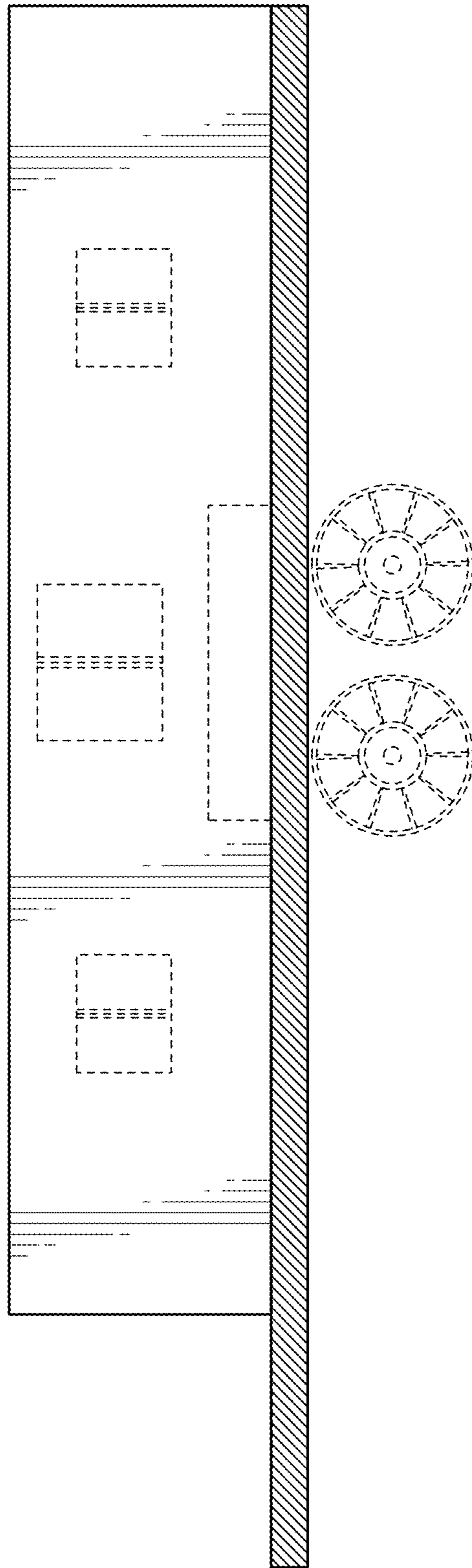

FIG. 2



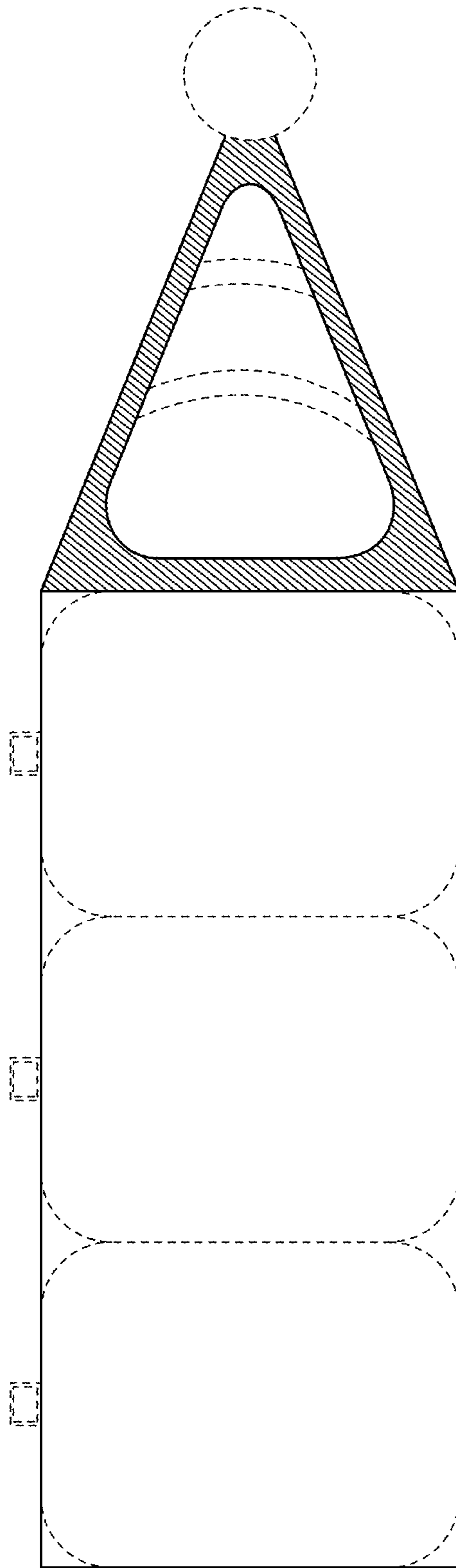

FIG. 3

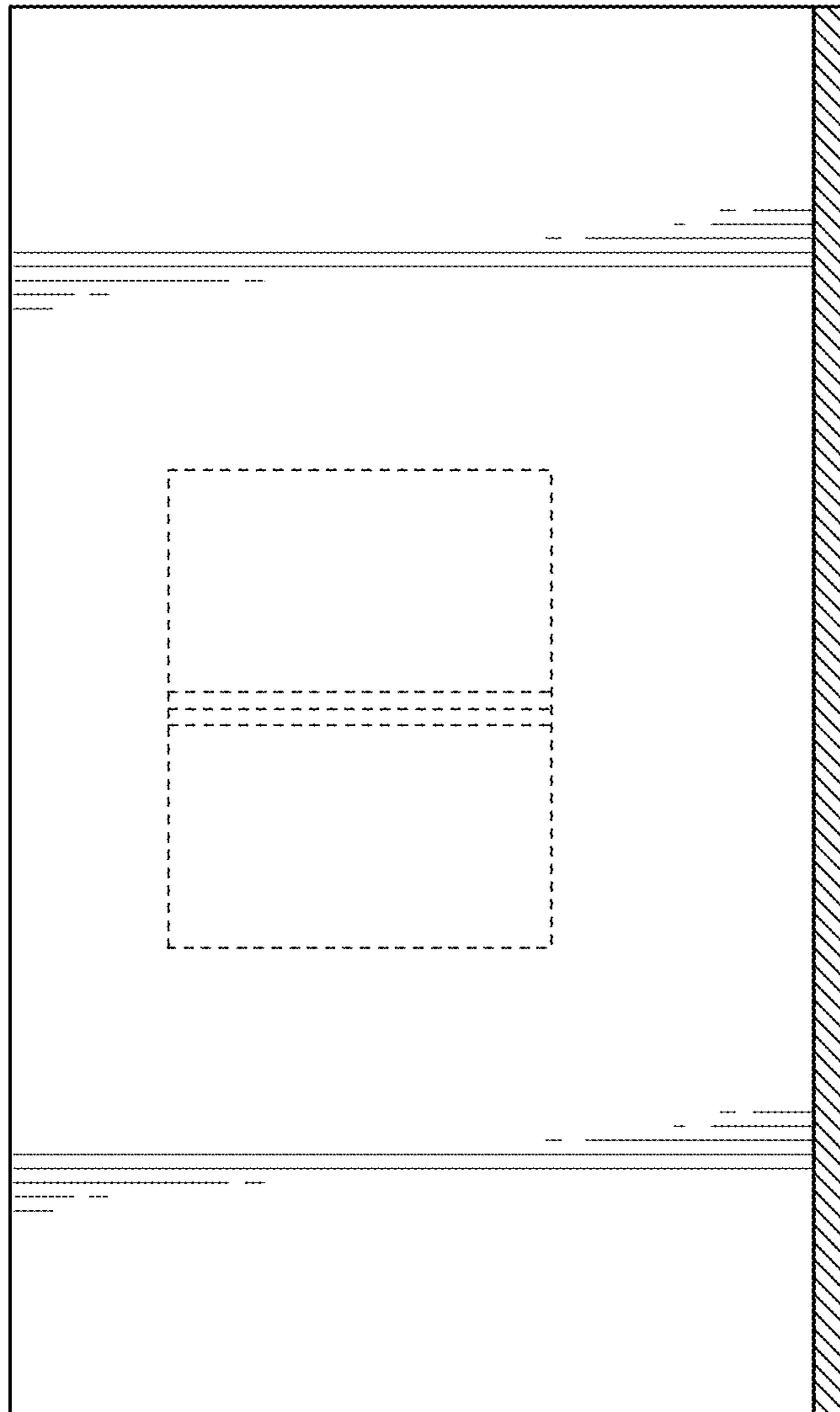

FIG. 4

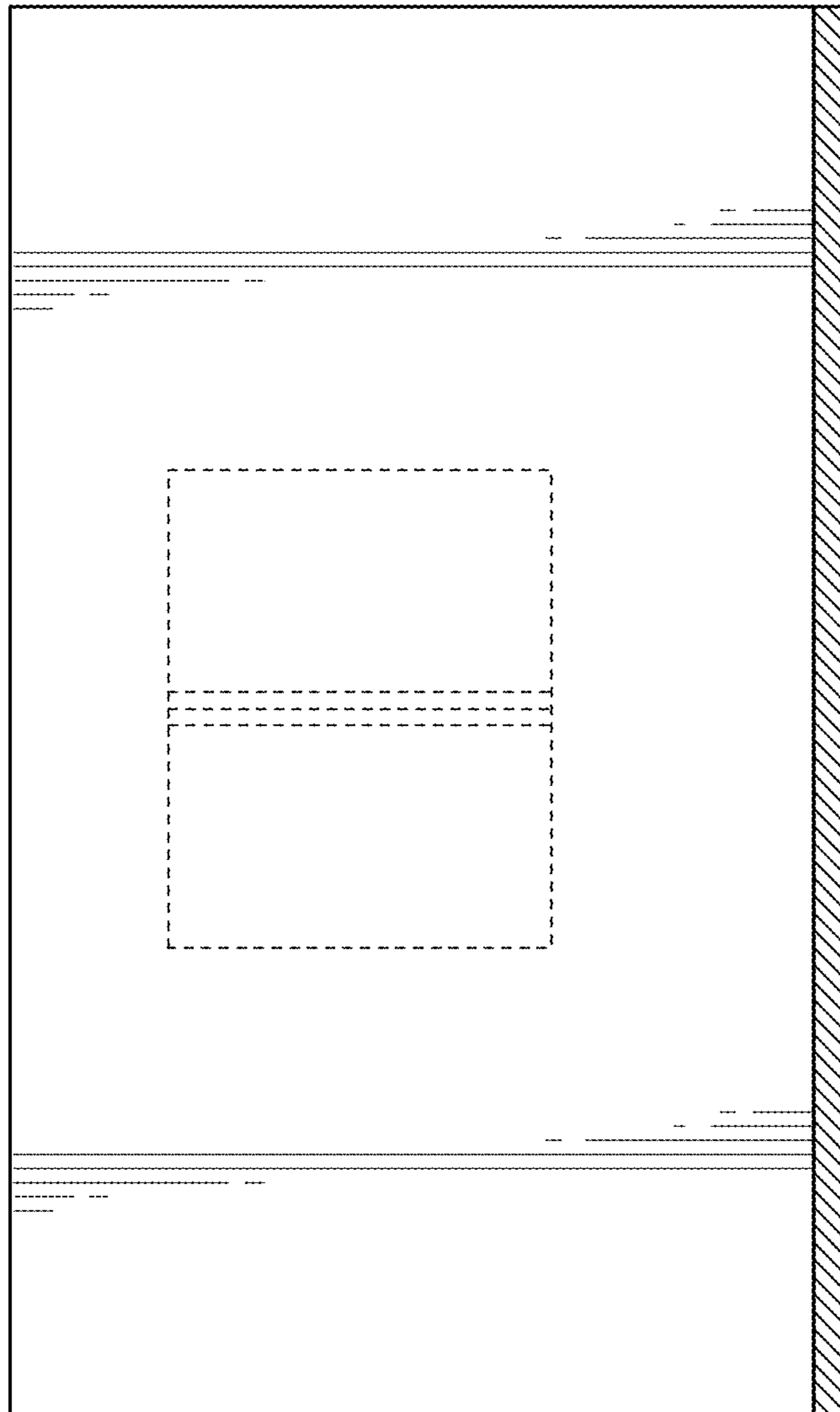

FIG. 5

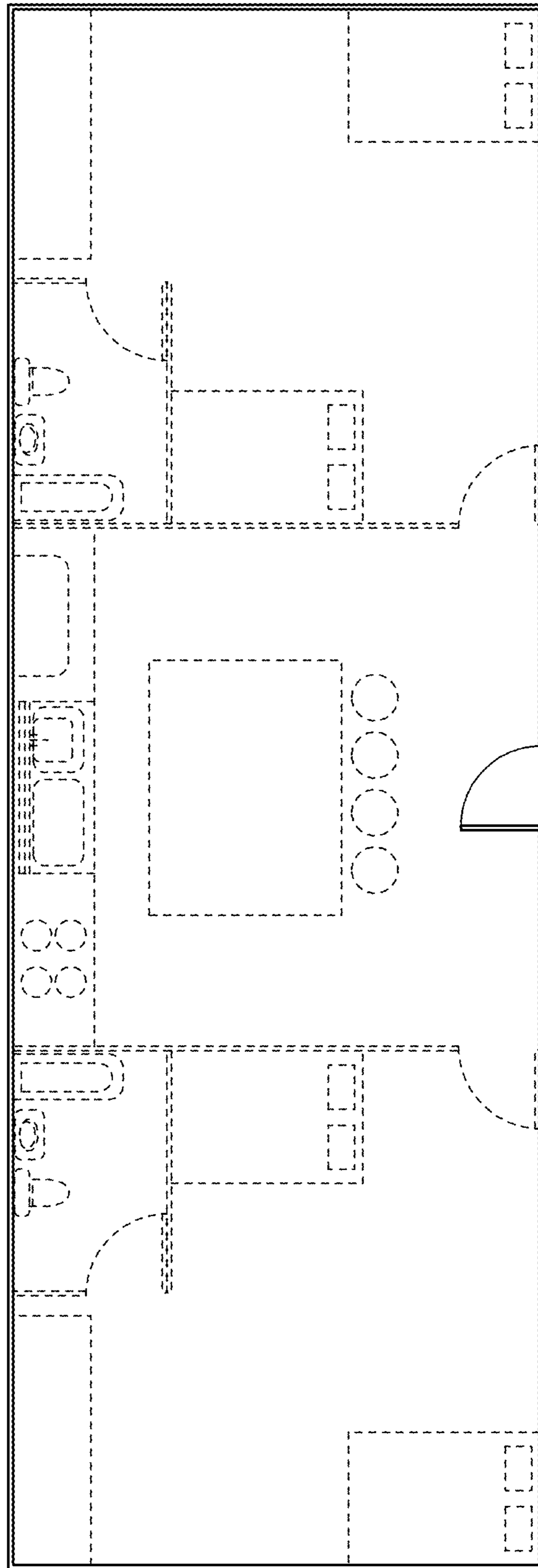

FIG. 6