



US00D891429S

(12) **United States Design Patent**
Hsu et al.

(10) **Patent No.:** **US D891,429 S**
(45) **Date of Patent:** **** Jul. 28, 2020**

(54) **CONTROLLER**

(71) Applicant: **Disney Enterprises, Inc.**, Burbank, CA (US)

(72) Inventors: **Jonathan RD Hsu**, Pomona, CA (US);
Nathan D. Nocon, Valencia, CA (US)

(73) Assignee: **Disney Enterprises, Inc.**, Burbank, CA (US)

(**) Term: **15 Years**

(21) Appl. No.: **29/648,497**

(22) Filed: **May 22, 2018**

(51) **LOC (12) Cl.** **14-02**

(52) **U.S. Cl.**
USPC **D14/400**; D21/333

(58) **Field of Classification Search**
USPC D14/400–418, 426–431, 454–455, 203.3,
D14/218, 300, 356, 358, 383, 388, 399,
D14/432; D21/324, 328, 331, 333, 566;
D13/162, 162.1, 168; D10/78, 103
CPC .. A63F 9/02; A63F 9/24; A63F 9/0291; A63F
9/0252; A63F 13/00; A63F 13/23; A63F
13/24; A63F 13/26; A63F 13/98; A63F
13/02; A63F 13/12

See application file for complete search history.

(56) **References Cited**

U.S. PATENT DOCUMENTS

D380,208 S *	6/1997	Taylor	D14/388
D478,330 S *	8/2003	Yang	D14/402
D547,304 S *	7/2007	Francz	D14/218
D551,660 S *	9/2007	Francz	D14/218
D586,331 S *	2/2009	Francz	D14/218
D596,141 S *	7/2009	Boaz	D13/168
D646,335 S *	10/2011	Daniel	D21/333
D772,986 S	11/2016	Chen et al.	
D777,165 S *	1/2017	Chen	D14/426
D780,807 S	3/2017	Chen et al.	
D800,841 S	10/2017	Chen et al.	

D804,579 S *	12/2017	Britt	D21/333
D804,580 S *	12/2017	Britt	D21/333
D806,173 S *	12/2017	Britt	D21/333
D812,144 S	3/2018	Chandrasiri et al.	
D815,210 S *	4/2018	Chen	D21/333
D817,300 S *	5/2018	Bristol	D14/203.3
D823,397 S *	7/2018	Nokuo	D21/333
D835,104 S	12/2018	Chen et al.	
D844,609 S *	4/2019	Bristol	D14/388
D864,301 S *	10/2019	Wei	D21/333

(Continued)

OTHER PUBLICATIONS

“Valve’s Index VR Headset Ships in June, Full Set Costs Over \$1400,” Valve Index Controller pictured therein, online, post date May 1, 2019, URL: <https://www.kotaku.com.au/2019/05/valves-index-vr-headset-ships-in-june-full-set-costs-1000/>, retrieved Mar. 24, 2020.*

Primary Examiner — Jeffrey D Asch

Assistant Examiner — Rebekah A Caruso

(74) *Attorney, Agent, or Firm* — Patterson + Sheridan, LLP

(57) **CLAIM**

The ornamental design for a controller, as shown and described.

DESCRIPTION

FIG. 1 is a perspective view of a controller showing our new design;

FIG. 2 is another perspective view thereof;

FIG. 3 is a left side elevational view thereof;

FIG. 4 is a right side elevational view thereof;

FIG. 5 is a rear elevational view thereof;

FIG. 6 is a front elevational view thereof;

FIG. 7 is a top plan view thereof; and,

FIG. 8 is a bottom plan view thereof.

The broken line portions of the controller form no part of the claimed design.

1 Claim, 6 Drawing Sheets

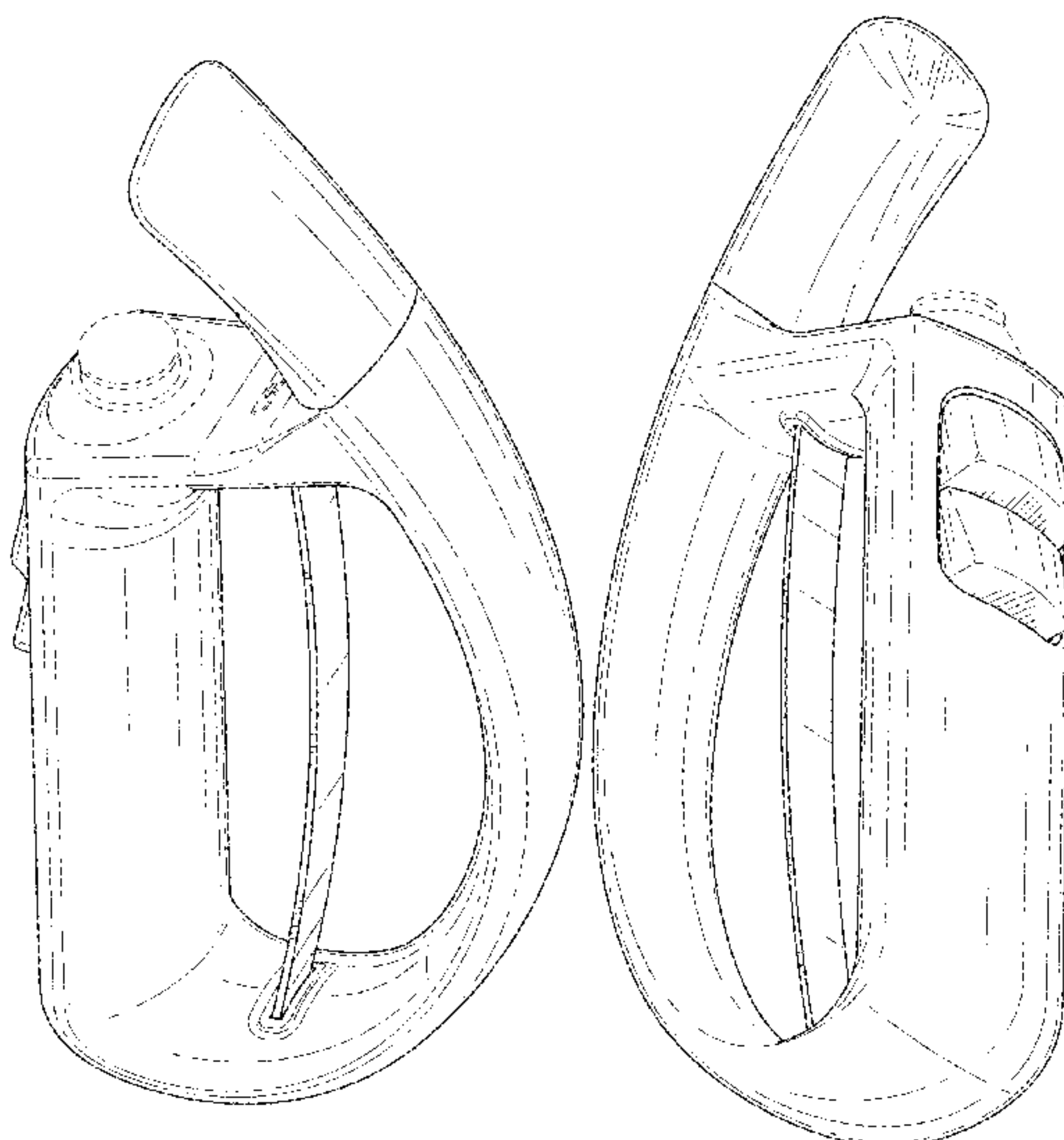

(56)

References Cited

U.S. PATENT DOCUMENTS

10,549,183 B2 * 2/2020 Hope A63F 13/428
2016/0261731 A1 * 9/2016 Doolin B62K 11/14
2018/0099219 A1 * 4/2018 Hope A63F 13/218

* cited by examiner

FIG. 1

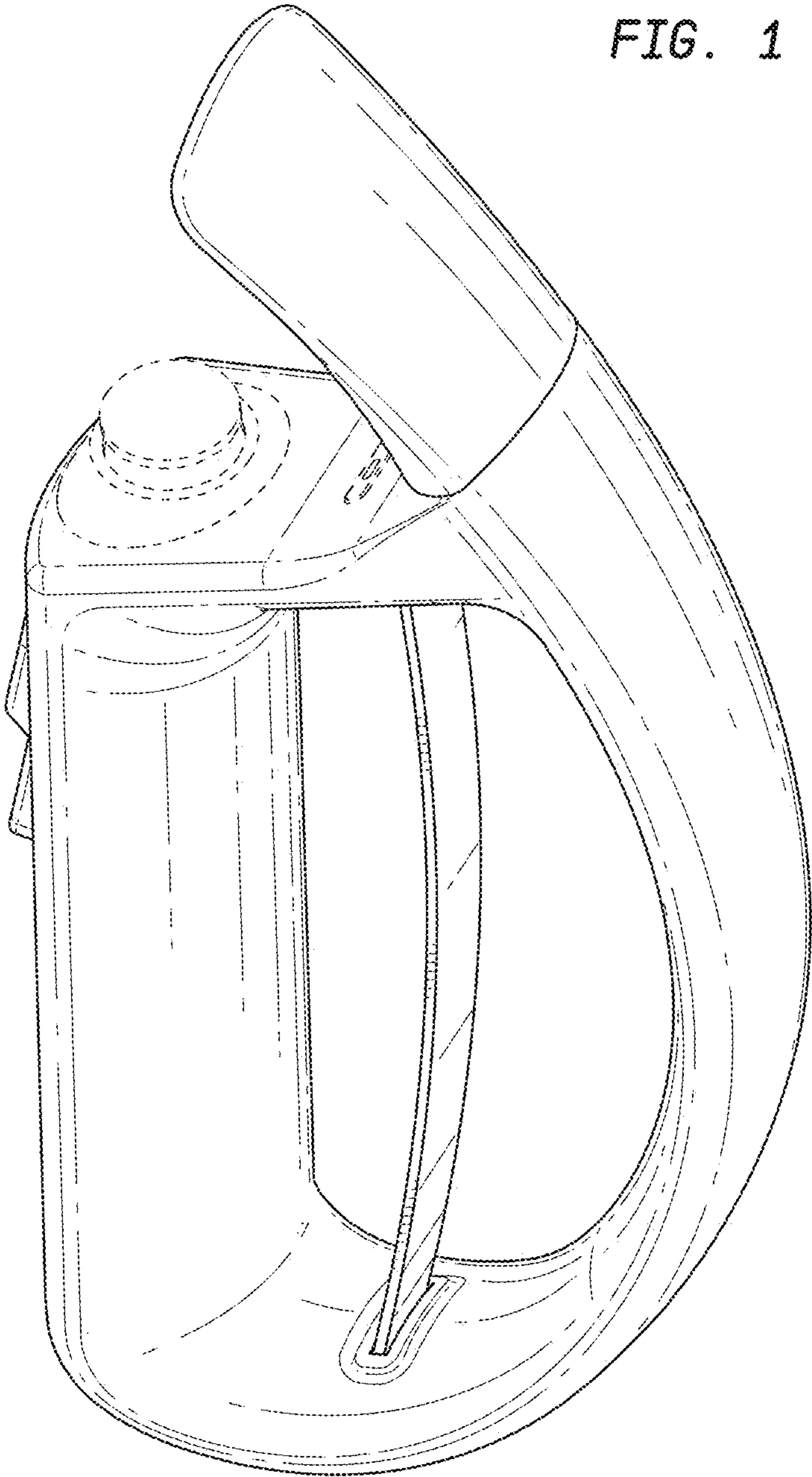

FIG. 2

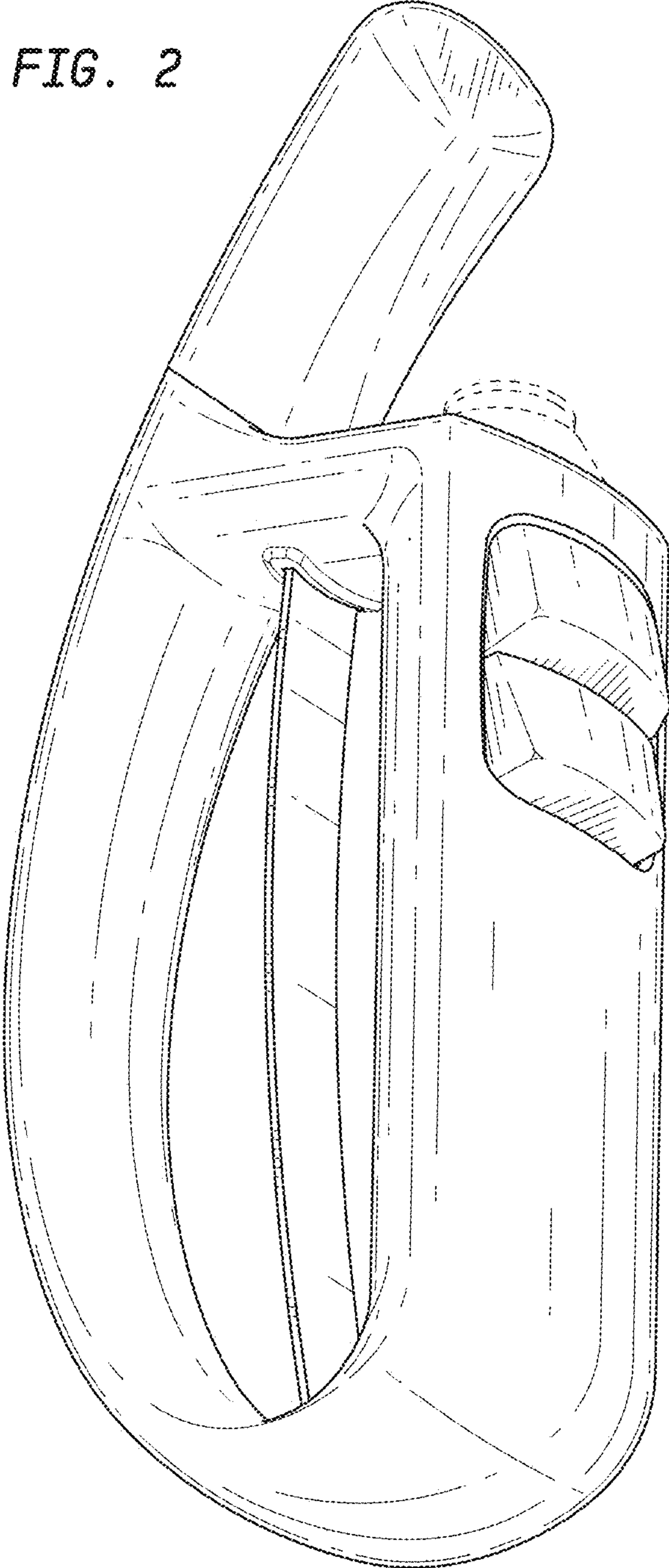

FIG. 3

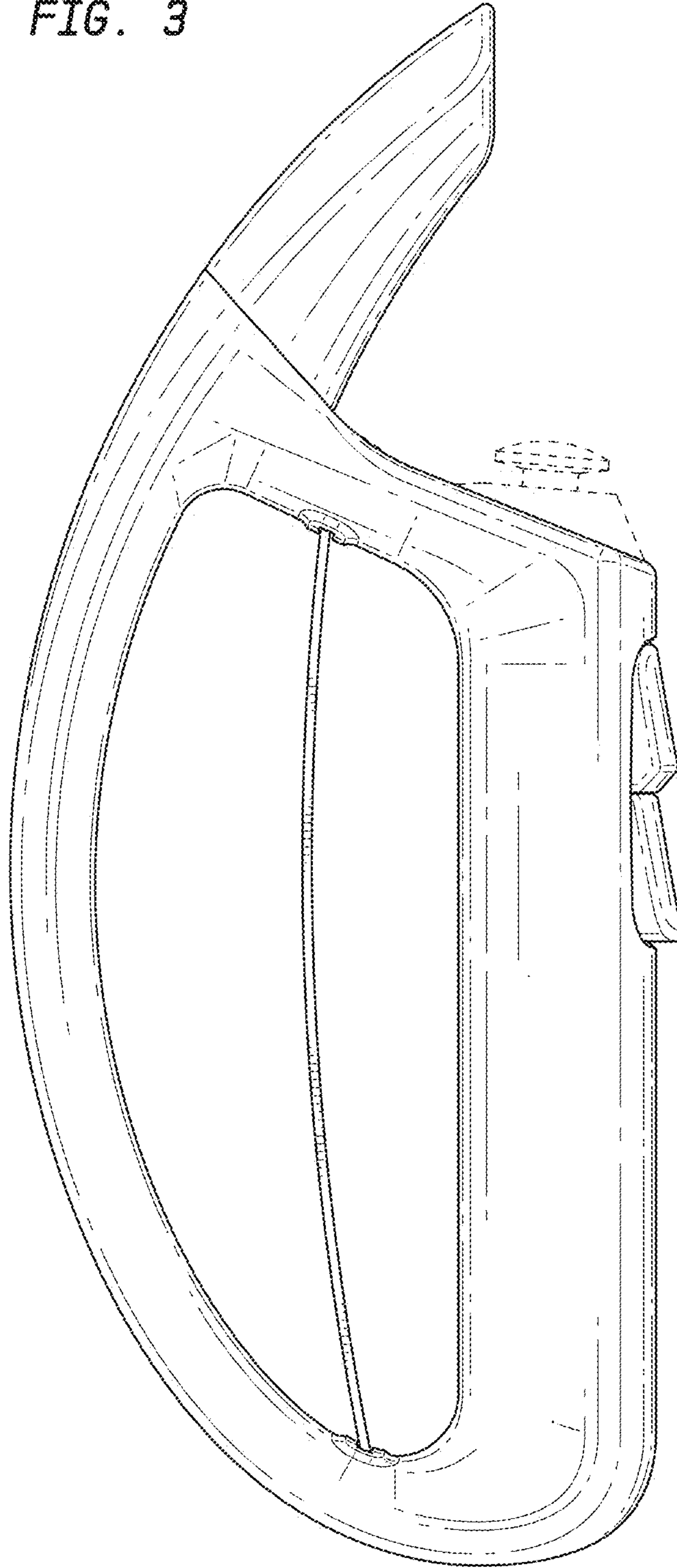

FIG. 4

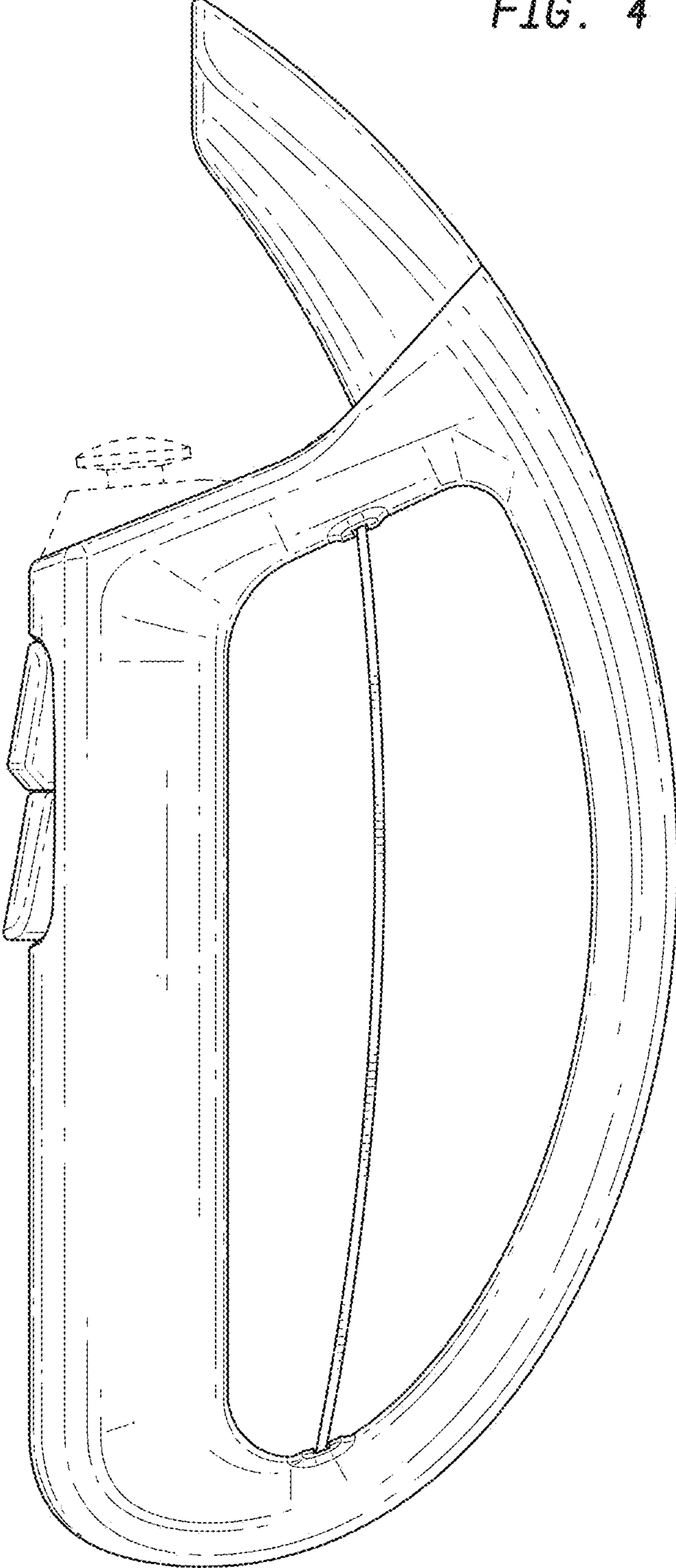

FIG. 5

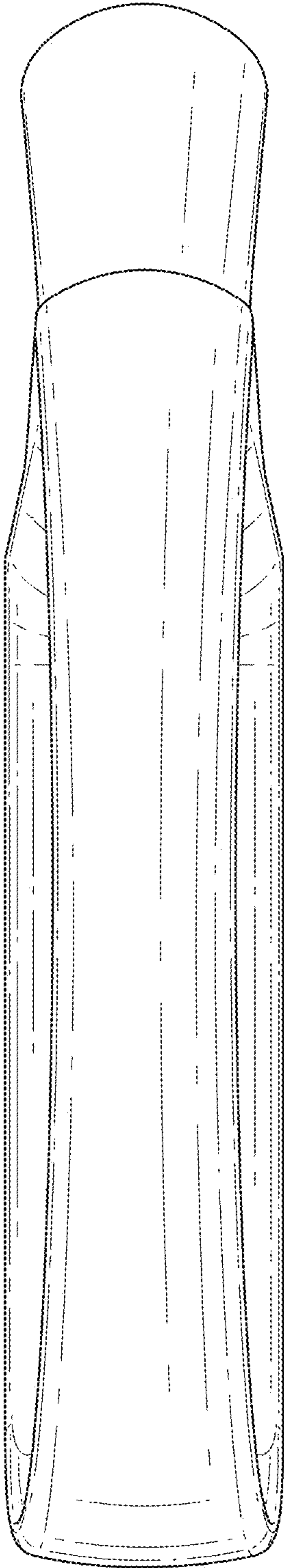

FIG. 6

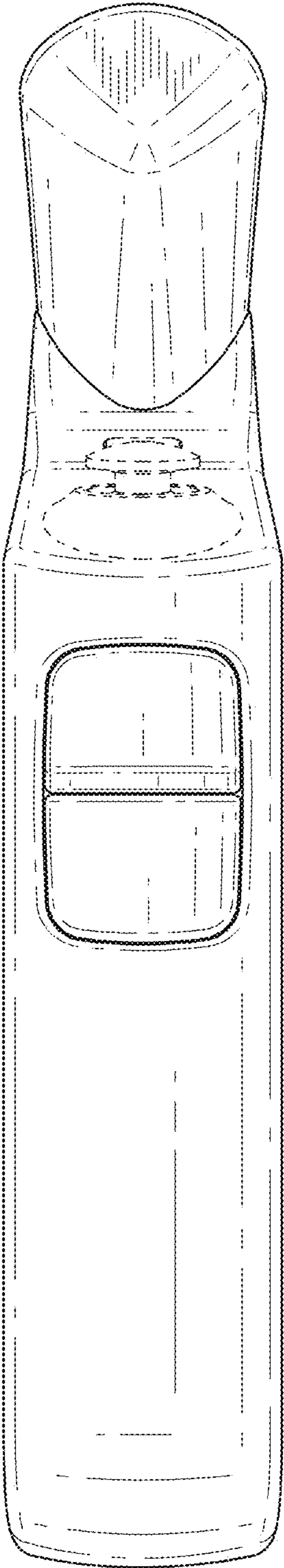

FIG. 7

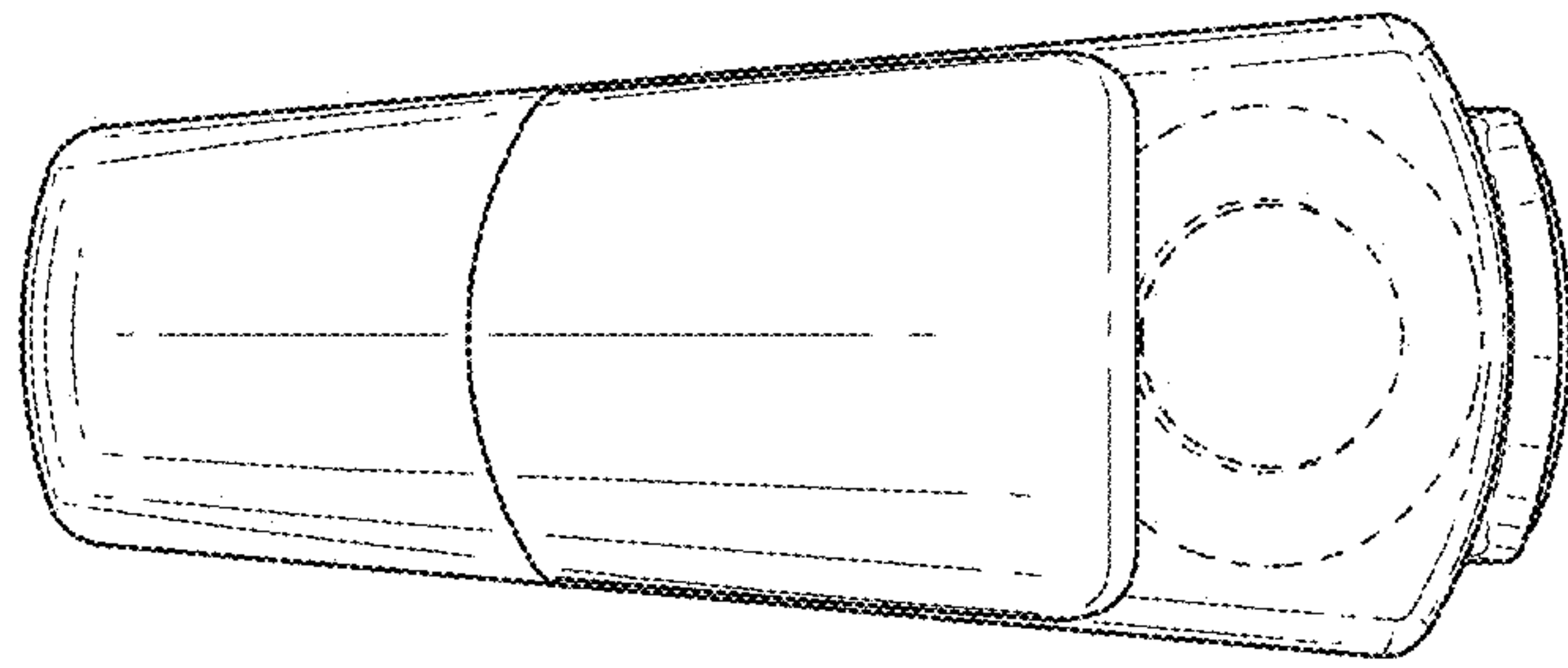

FIG. 8

