



US00D891316S

(12) **United States Design Patent** (10) **Patent No.:** **US D891,316 S**
Shao (45) **Date of Patent:** **** Jul. 28, 2020**

(54) **AUTOMOBILE FRONT GRILLE**
(71) Applicant: **MOTI 5, INC.**, Flushing, NY (US)
(72) Inventor: **Liang Shao**, Flushing, NY (US)
(73) Assignee: **Moti 5, Inc.**, Flushing, NY (US)
(**) Term: **15 Years**
(21) Appl. No.: **29/688,549**
(22) Filed: **Apr. 23, 2019**
(51) **LOC (12) Cl.** **12-16**
(52) **U.S. Cl.**
USPC **D12/163**
(58) **Field of Classification Search**
USPC D12/169, 196, 86, 90-92, 163, 190, 98,
D12/164; 293/102, 113, 115, 117, 120,
293/193.11; 296/180.1, 180.2; 180/68.1,
180/68.6
CPC B60R 19/52; B60K 11/08; B62D 25/08;
B62B 9/16
See application file for complete search history.

D794,517 S 8/2017 Woolley
D800,226 S 10/2017 Zeng
D807,797 S * 1/2018 Peat D12/163
D810,626 S * 2/2018 Macey D12/91
D811,270 S * 2/2018 Zhang D12/91
D814,354 S * 4/2018 Fisker D12/91
D815,571 S 4/2018 Zhang
D819,510 S 6/2018 Zhang
(Continued)

FOREIGN PATENT DOCUMENTS

CN 303158902 S 10/2014
CN 303367473 S 3/2015
(Continued)

OTHER PUBLICATIONS

Smartkadely, Angry Birds Grille Front Grille for Jeep Wrangler Rubicon Sahara JK Jul. 2017, Front Hood Bumper Mat, accessed Jan. 1, 2019. <https://www.amazon.fr/Grille-Wrangler-Rubicon-07-2017-Capuche/dp/B075R997BG>.
(Continued)

Primary Examiner — Melody N Brown
(74) *Attorney, Agent, or Firm* — Rimon PC

(56) **References Cited**
U.S. PATENT DOCUMENTS

D507,214 S 7/2005 Marchese et al.
D519,066 S 4/2006 Ney et al.
D521,424 S 5/2006 Sackley
D534,458 S * 1/2007 Renkert D12/91
D554,563 S * 11/2007 Moushegian D12/91
D588,964 S 3/2009 Matsuoka et al.
D683,668 S 6/2013 Thurber
D713,303 S 9/2014 Nishio
D730,786 S 6/2015 Duff et al.
D731,922 S * 6/2015 Beaven D12/91
D746,731 S 1/2016 Quezada
D749,995 S 2/2016 Azadi et al.
D777,065 S * 1/2017 Patel D12/163
D777,614 S 1/2017 Wheel
D790,412 S 6/2017 Dunford et al.

(57) **CLAIM**
The ornamental design for an automobile front grille, as shown and described.

DESCRIPTION

FIG. 1 is a top, front and side perspective view of an automobile front grille showing my new design;
FIG. 2 is a front elevation view thereof;
FIG. 3 is a rear elevational view thereof;
FIG. 4 is a side elevational view thereof;
FIG. 5 is an opposite side elevational view thereof;
FIG. 6 is a top plan view thereof; and,
FIG. 7 is a bottom plan view thereof.

1 Claim, 5 Drawing Sheets

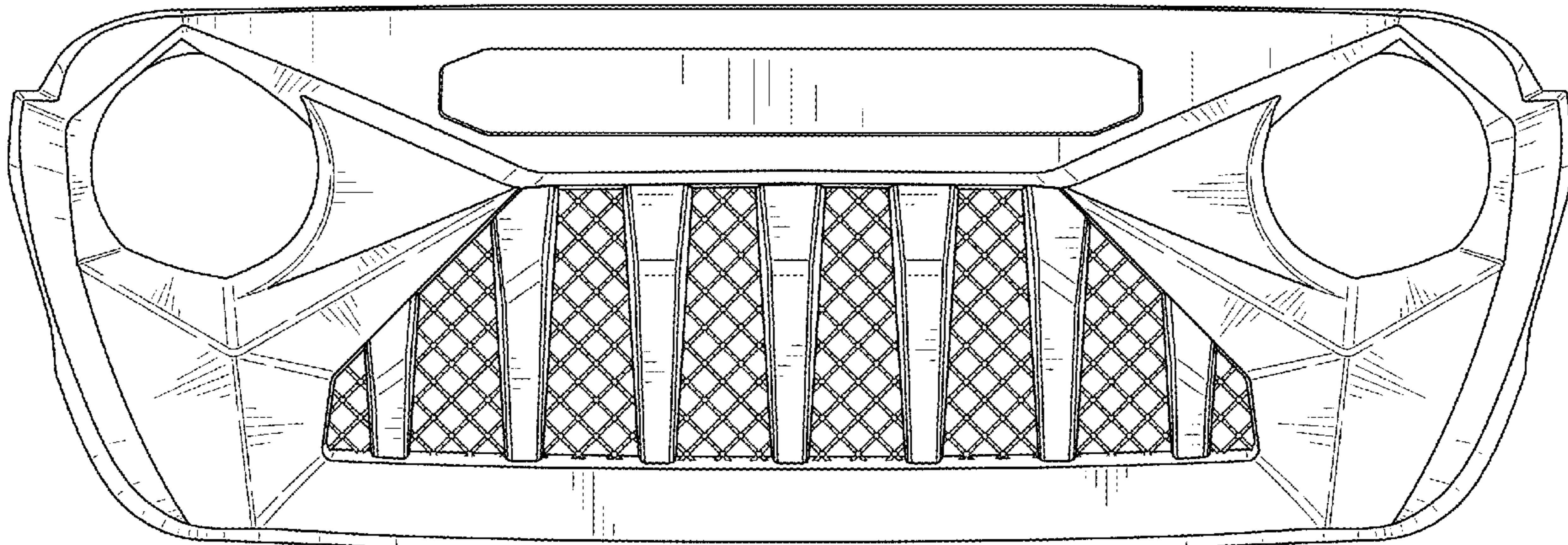

(56)

References Cited

U.S. PATENT DOCUMENTS

D826,107	S	8/2018	DiCanzio	
D827,495	S *	9/2018	Piscitelli	D12/91
D828,223	S *	9/2018	Piscitelli	D12/91
D829,144	S	9/2018	Zeng	
D840,881	S	2/2019	Zhang	
D842,172	S	3/2019	Chi	
D842,175	S *	3/2019	Hartenstein	D12/163
D847,025	S *	4/2019	Zavatski	D12/91
D871,979	S *	1/2020	Zheng	D12/163
D876,997	S *	3/2020	Zeng	D12/163
D883,150	S *	5/2020	Li	D12/163

FOREIGN PATENT DOCUMENTS

CN	303428541	S	7/2015
CN	303929977	S	2/2016
CN	303911914	S	5/2016
CN	303930216	S	5/2016
CN	303977934	S	7/2016
CN	304004775	S	7/2016
CN	304088133	S	7/2016
CN	304407233	S	6/2017
CN	304407234	S	6/2017
CN	304898373	S	11/2018
CN	305031704	S	2/2019
CN	305249734	S	7/2019
CN	305249735	S	7/2019
DM	67940-005		6/2006
EM	003344746-0001		8/2016
JP	D1477965		7/2013
KR	30-0480989		7/2007

OTHER PUBLICATIONS

CJ'S OffRoad, Rough Country Grille Angry Eyes Jeep Wrangler JK 2007-2018, accessed Jan. 1, 2019. <https://www.cjponyparts.com/rough-country-grille-angry-eyes-jeep-wrangler-jk-2007-2018/p/RC10524/>.

Xprite, Xprite Gladiator Vader Grille Grill with Mesh for 2007-2018 Jeep Rubicon Sahara Sport JK JKU, accessed Jan. 1, 2019. <https://www.amazon.com/Xprite-Wrangler-Gladiator-2007-2018-Rubicon/dp/B07CZ33NP9>.

Xprite, Xprite Gladiator Grille For TITAN Offroad—(TJ/LJ 1997-2006), accessed Jan. 1, 2019. <https://www.jeeppeople.com/xprite-gladiator-grille-for-jeep-wrangler-tj-lj-1997-2006/>.

AUXMART Grille Ghost Grill Grid for Jeep Wrangler JK 2007-2017, accessed Jan. 1, 2019. https://www.amazon.com/AUXMART-Grille-Ghost-Wrangler-2007-2016/dp/B01CFKS72K?ref_=Oct_TopRatedC_15736001_4&pf_rd_p=48b47916-a8c6-5d31-888b-d09262140194&pf_rd_s=merchandised-search-6&pf_rd_t=101&pf_rd_i=15736001&pf_rd_m=ATVPDKIKX0DER&pf_rd_r=EXMBVB0PRHGZMR.

Deegan, Deegan 38 Grille w/ 10 in. LED Light Bar, accessed Jan. 1, 2019. <https://www.extremeterrain.com/deegan-38-grille-w-10-led-light-bar-0717-jk.html#>.

Cliffride, Holcomb Grille w/ 22 in. LED Light Bar (Jul. 2018 Jeep Wrangler JK), accessed Jan. 1, 2019. <https://www.extremeterrain.com/cliffride-holcomb-grille-22in-led-lightbar-0717.html>.

V-SEK, Gladiator Angry Skull Front Matte Black Grille Grid Grill for Jeep Wrangler Rubicon Sahara Sport JK JKU 2007-2017, accessed Jan. 1, 2019. <https://www.amazon.com/V-SEK-Gladiator-Wrangler-Rubicon-2007-2017/dp/B07FZYB3R1>.

Rugged Ridge, LED Mesh Grille Insert, Jun. 2016 Monthly Update, accessed Jan. 1, 2019. <http://www.ruggedridge.com/blog/tag/grille/>.

Barricade, Matte Black Grille Cover (Jul. 2018 Jeep Wrangler JK), accessed Jan. 1, 2019. <https://www.extremeterrain.com/barricade-grille-cover-jk-j100721.html>.

Xprite, New Generation G2 Matte Black Angry Bird Grille Grid Grill Overlay for 1997-2006 Jeep Wrangler TJ LJ, accessed Jan. 1, 2019. <https://www.amazon.com/Xprite-Grille-Wrangler-Rubicon-2007-2018/dp/B01ETX4QOY>.

CAR CLUB, Matte Black Angry Bird Grille Cover Front Grill GuardFits Jeep Wrangler TJ 97-06, accessed Jan. 1, 2019. <https://www.ebay.com/itm/183593106559>.

Iturning, 7PC Grille Inserts, Mattle Black Grill Guards Mesh for Jeep Wrangler TJ 97-06, accessed Jan. 1, 2019. <https://www.ebay.com/itm/372465278528>.

Xprite, New Generation G2 Matte Black Angry Bird Grille Grill for 97-06 Jeep Wrangler TJ, accessed Jan. 1, 2019. <https://www.ebay.com/itm/292897553841>.

Walmart, Durable decorative grille vehicle modified parts, available at: <https://www.walmart.com/ip/Upgrade-Upgrade-Grilles-For-Jeep-Vehicle-Front-Grill-For-Jeep-For-Wrangler-2007-2017-Durable-Decorative-Grille-Vehicle-Modified-Parts/563021602>; accessed Aug. 23, 2019.

HIDLED, Angry bird style front grill auto replaceable front grille for jeep wrangler, Item Code: HL-86, available at: http://www.hidled.com/angry-bird-style-front-grill-auto-replaceable-front-grille-for-jeep-wrangler_p0086.html; accessed Aug. 23, 2019.

Aliexpress, Car front grill grille mesh insert for jeep wrangler sports sahara freedom rubicon etc 2007-2017 automobile accessories black, available at <https://www.aliexpress.com/item/32951737198.html>; accessed Aug. 23, 2019.

* cited by examiner

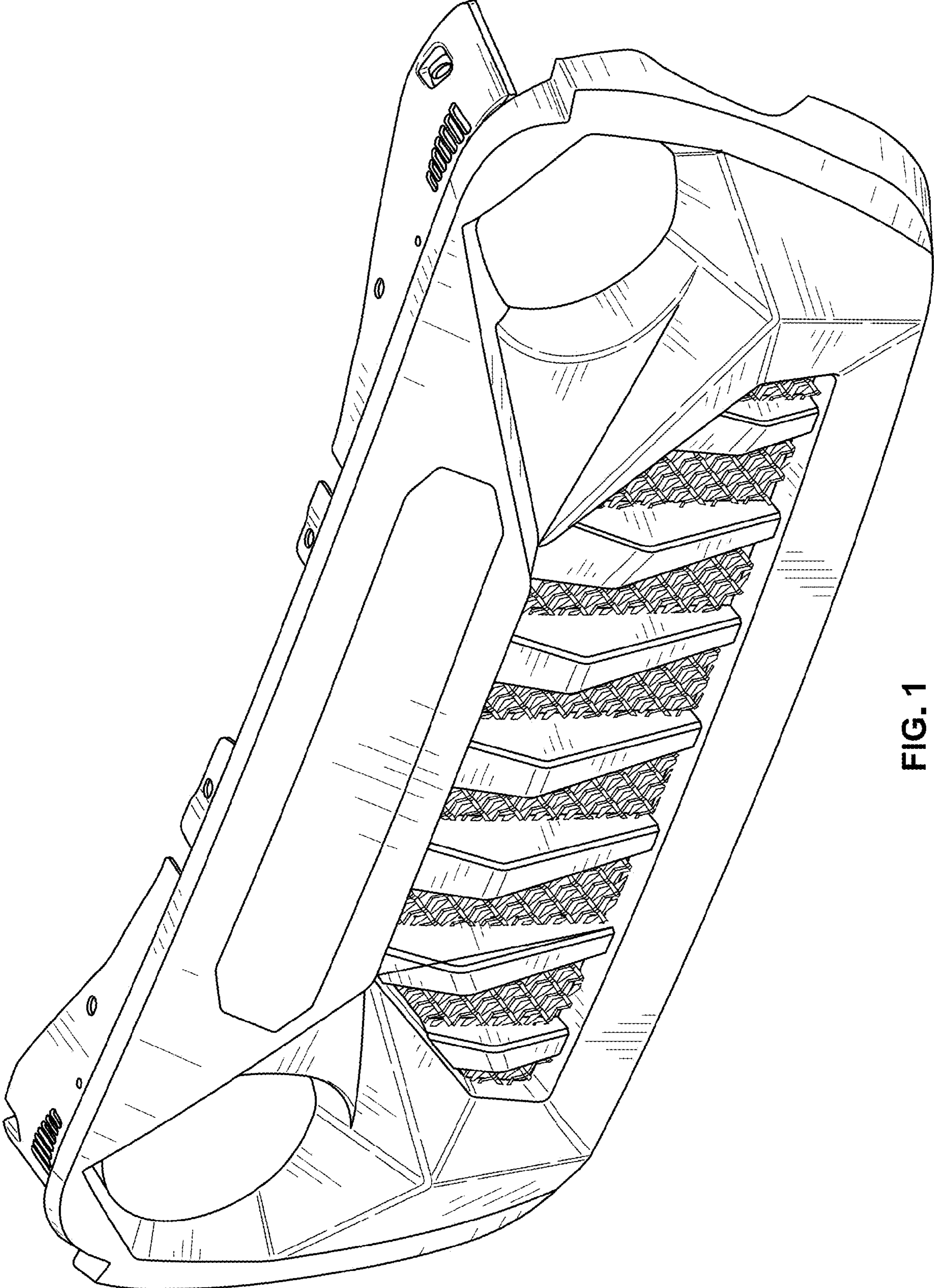

FIG. 1

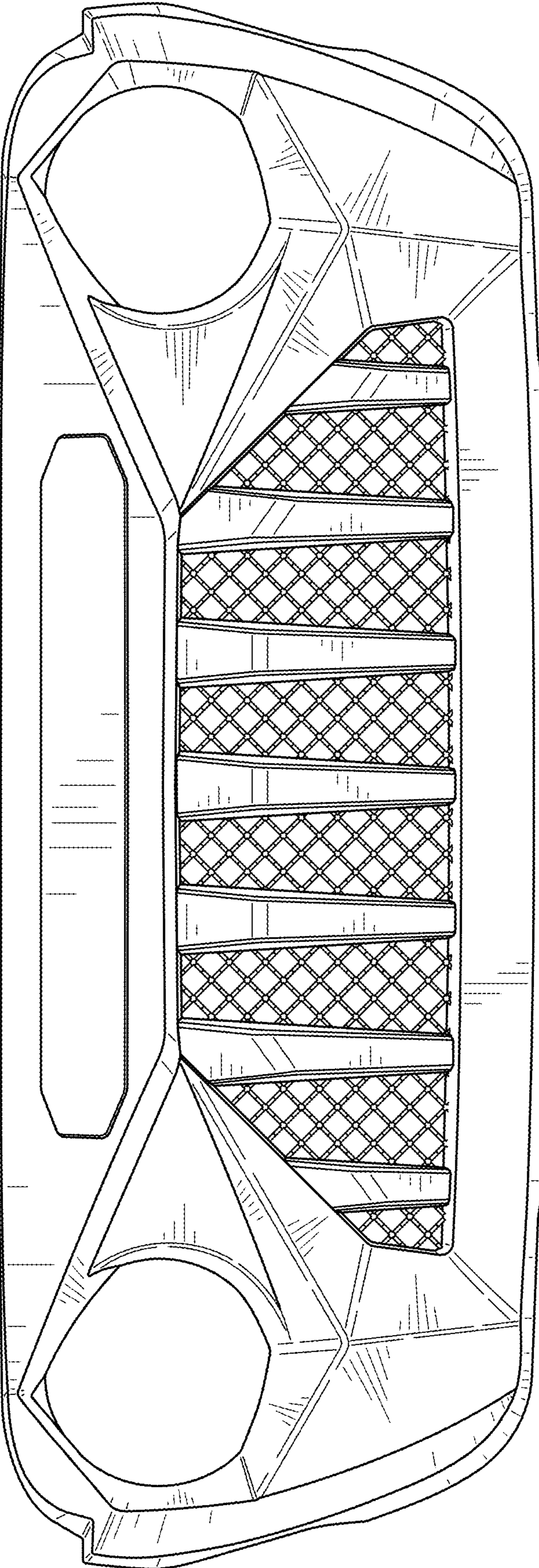

FIG. 2

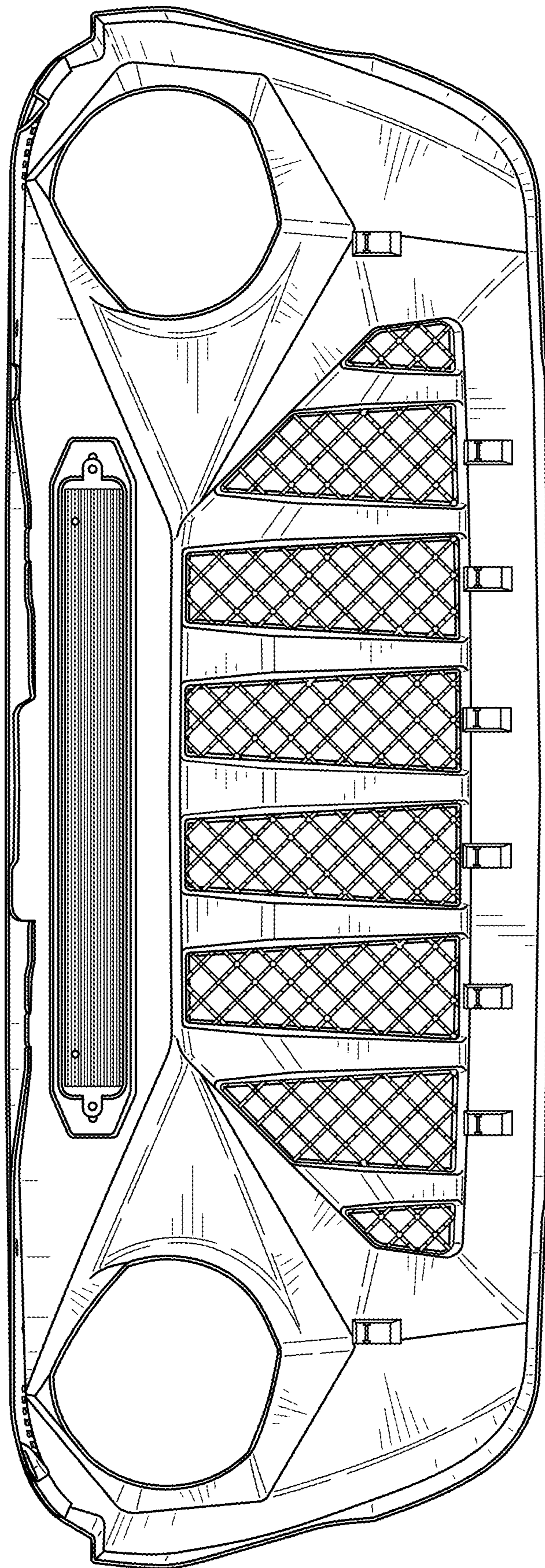

FIG. 3

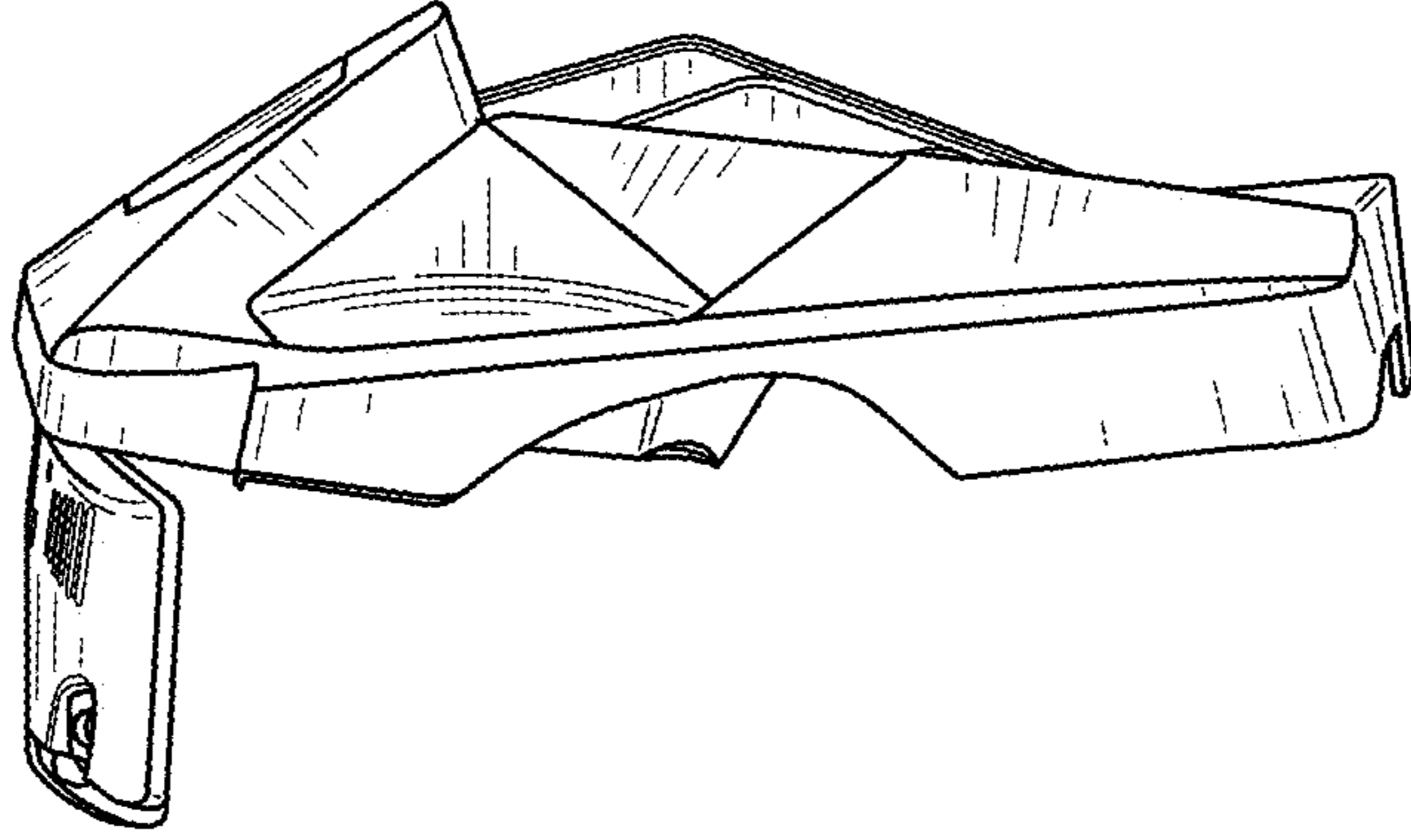

FIG. 5

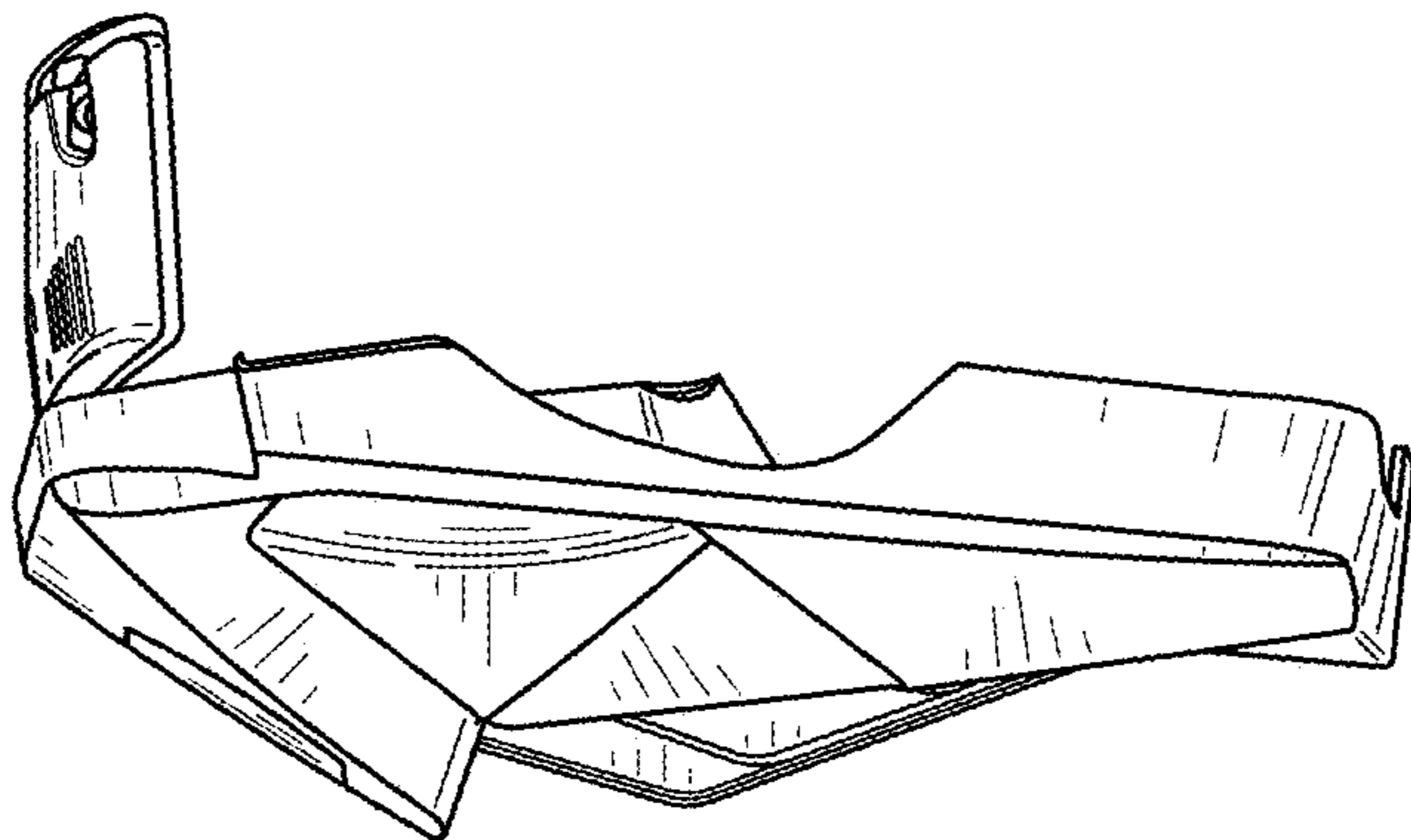

FIG. 4

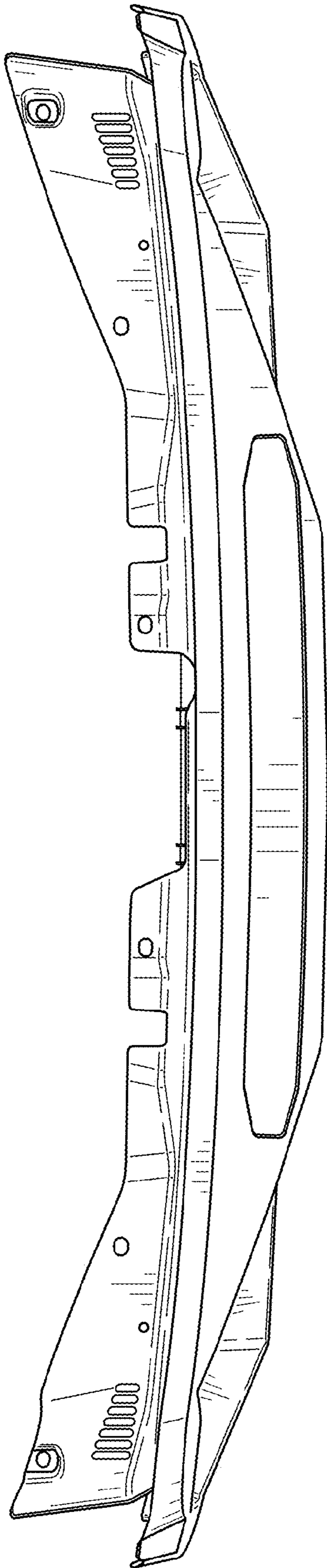

FIG. 6

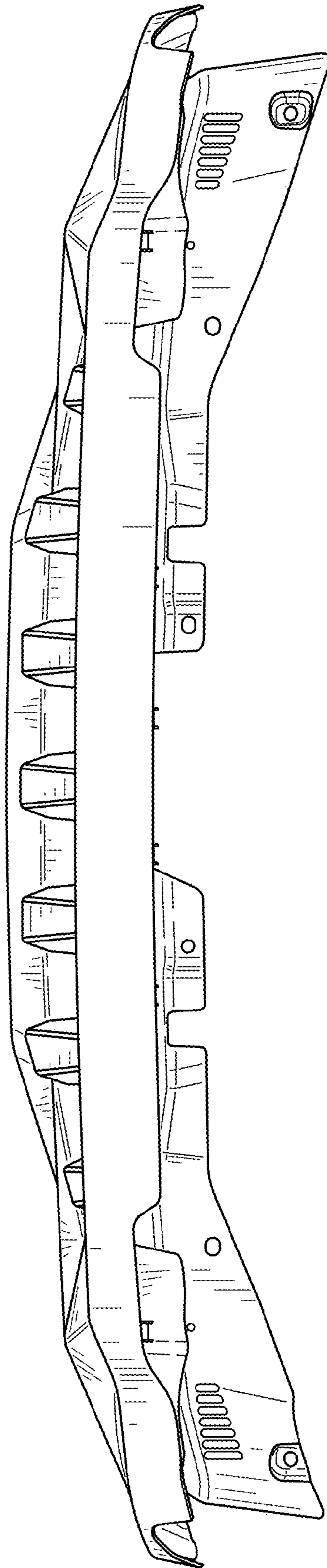

FIG. 7