



US00D891273S

(12) **United States Design Patent**
Atalay

(10) **Patent No.:** **US D891,273 S**
(45) **Date of Patent:** **** Jul. 28, 2020**

- (54) **FOOD PACKAGING**
- (71) Applicant: **Selçuk Atalay**, Izmir (TR)
- (72) Inventor: **Selçuk Atalay**, Izmir (TR)
- (73) Assignee: **SDA Gıda Tarım Urt. İth. İhr. San. Ve. Tic. A.S.**, Manisa (TR)
- (**) Term: **15 Years**
- (21) Appl. No.: **29/667,518**
- (22) Filed: **Oct. 23, 2018**
- (51) **LOC (12) Cl.** **09-03**
- (52) **U.S. Cl.**
USPC **D9/759**
- (58) **Field of Classification Search**
USPC D9/762, 757, 737, 759, 761, 420-426, D9/432, 418, 415, 501, 72, 739, 742, 753, D9/756, 741, 721; D7/611, 550.1, 605, D7/701, 553.1, 553.2, 614, 703, 708; D3/313, 304, 311, 314, 315; D11/143, D11/155, 156; D24/227; 206/139, 206/201-203, 427, 265, 504, 518, 519, 206/524.1, 557, 561, 564, 565, 703, 704, 206/705, 523, 586, 515, 521.1, 521.15, 206/521.3, 521.6, 521.8, 521.4, 521.9, 206/406; 220/4.26, 508; 229/406
CPC B65D 5/5495; B65D 85/1072; B65D 5/5253; B65D 85/1063; B65D 5/0085; B65D 21/0204; B65D 5/427; B65D 21/0201; B65D 5/009; B65D 77/006; B65D 85/324; B65D 85/32; B65D 71/70; B65D 85/322; B65D 25/04
See application file for complete search history.

- (56) **References Cited**
U.S. PATENT DOCUMENTS
240,138 A * 4/1881 Jackson A21B 3/132
220/23.2
D223,145 S * 3/1972 Bloch D9/456

- 4,195,747 A * 4/1980 Hare A21B 3/134
220/23.2
- 5,393,539 A * 2/1995 Reskow B65D 77/003
206/557
- D380,300 S * 7/1997 Dalbo D3/313
- D387,559 S * 12/1997 Williamson D3/313
- D417,146 S * 11/1999 St. Pierre D9/732
- D420,283 S * 2/2000 Reichel D9/759
- D559,613 S * 1/2008 DeMirjian, III D7/357
- D591,175 S * 4/2009 Larson D9/425
- D616,250 S * 5/2010 Peyton D7/553.3
- D693,178 S * 11/2013 Wilson D7/553.2
- D707,077 S * 6/2014 Sarnoff D7/354
- D713,196 S * 9/2014 Sarnoff D7/357
- D713,741 S * 9/2014 Wilmers D9/424
- D804,964 S * 12/2017 Bennett D9/758
- D846,144 S * 4/2019 Fawdington D24/224
- D871,234 S * 12/2019 Grove D9/761
- 2010/0065562 A1 * 3/2010 Vovan B65D 1/30
220/23.4
- 2011/0072981 A1 * 3/2011 Tingley A21B 3/134
99/426

(Continued)

Primary Examiner — W. A. Teddy Falloway
(74) *Attorney, Agent, or Firm* — Minder Law Group;
Willy H. Hong

(57) **CLAIM**

The ornamental design for a food packaging, as shown and described.

DESCRIPTION

FIG. 1 is a front view of a food packaging in accordance with the present invention.
FIG. 2 is a back view thereof.
FIG. 3 is a left view thereof.
FIG. 4 is a right view thereof.
FIG. 5 is a top view thereof; and,
FIG. 6 is a bottom view thereof.

1 Claim, 6 Drawing Sheets

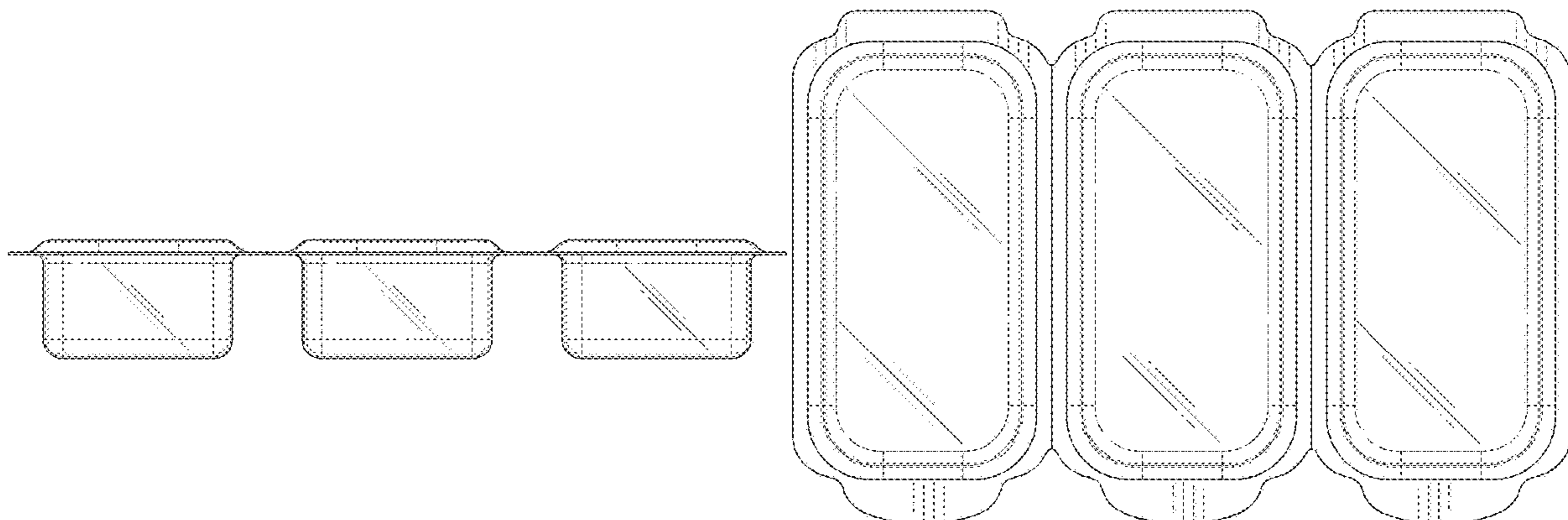

(56)

References Cited

U.S. PATENT DOCUMENTS

2012/0234832 A1 * 9/2012 Franczyk A45C 11/20
220/23.87

* cited by examiner

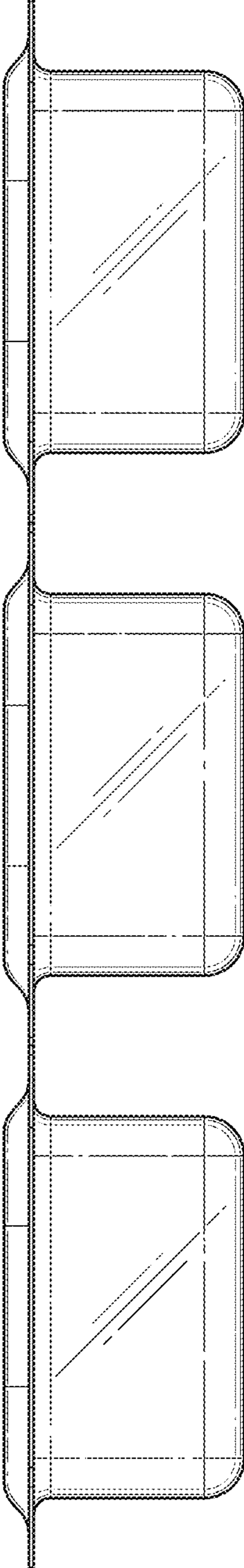

FIG. 1

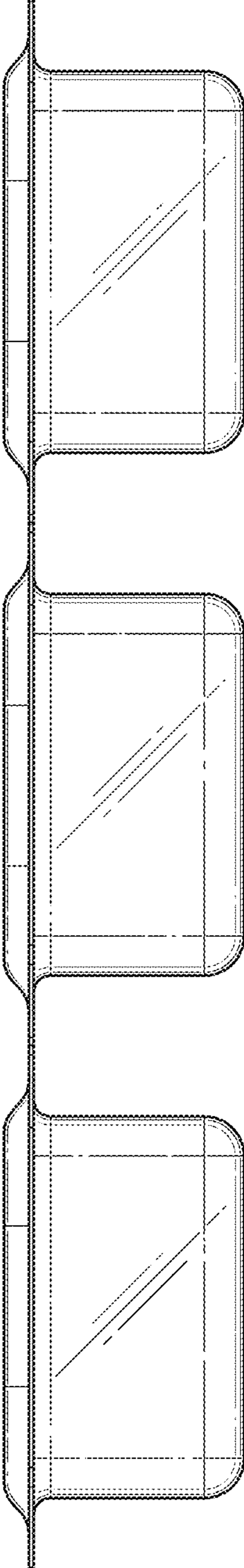

FIG. 2

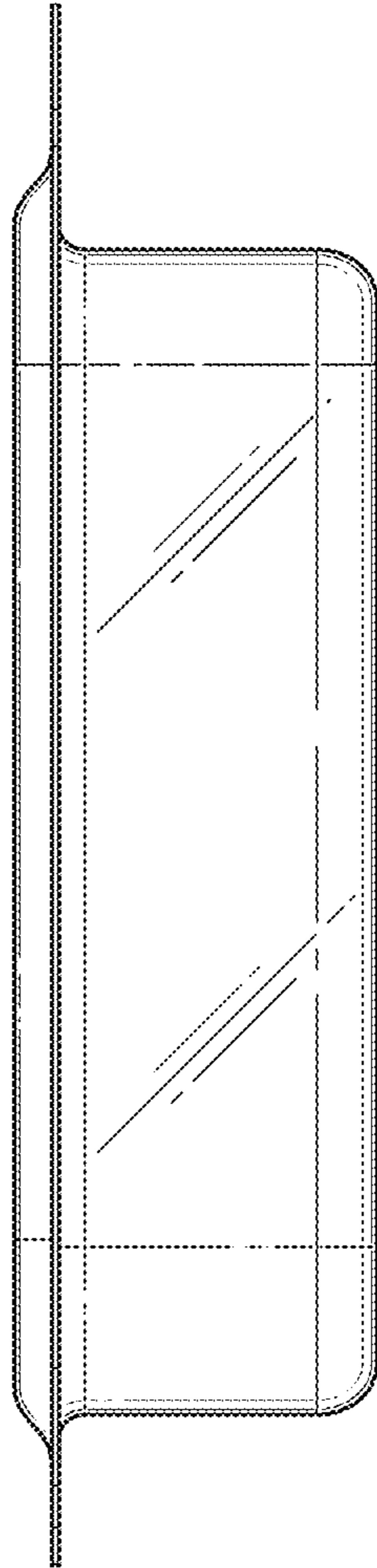

FIG. 3

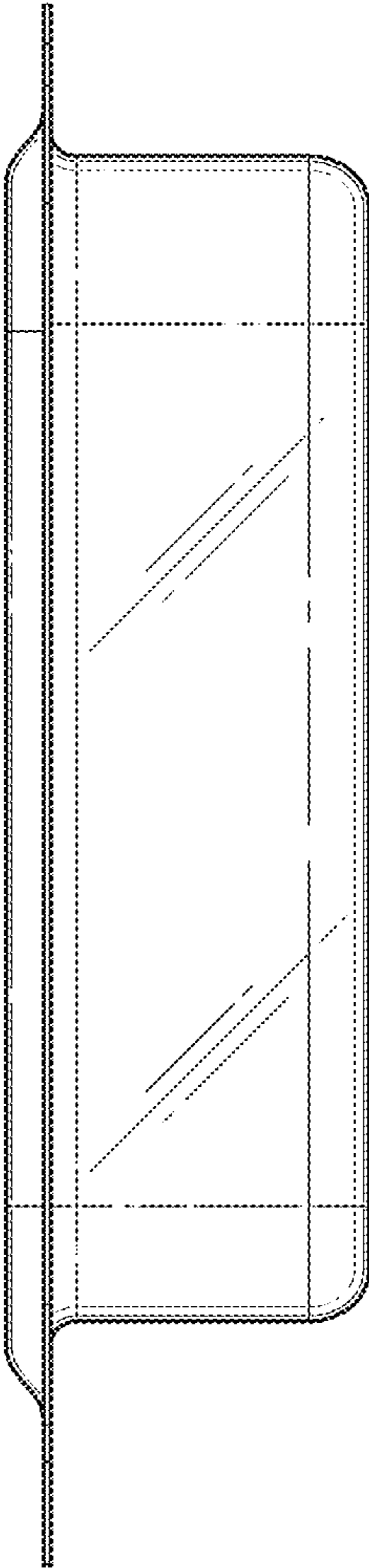

FIG. 4

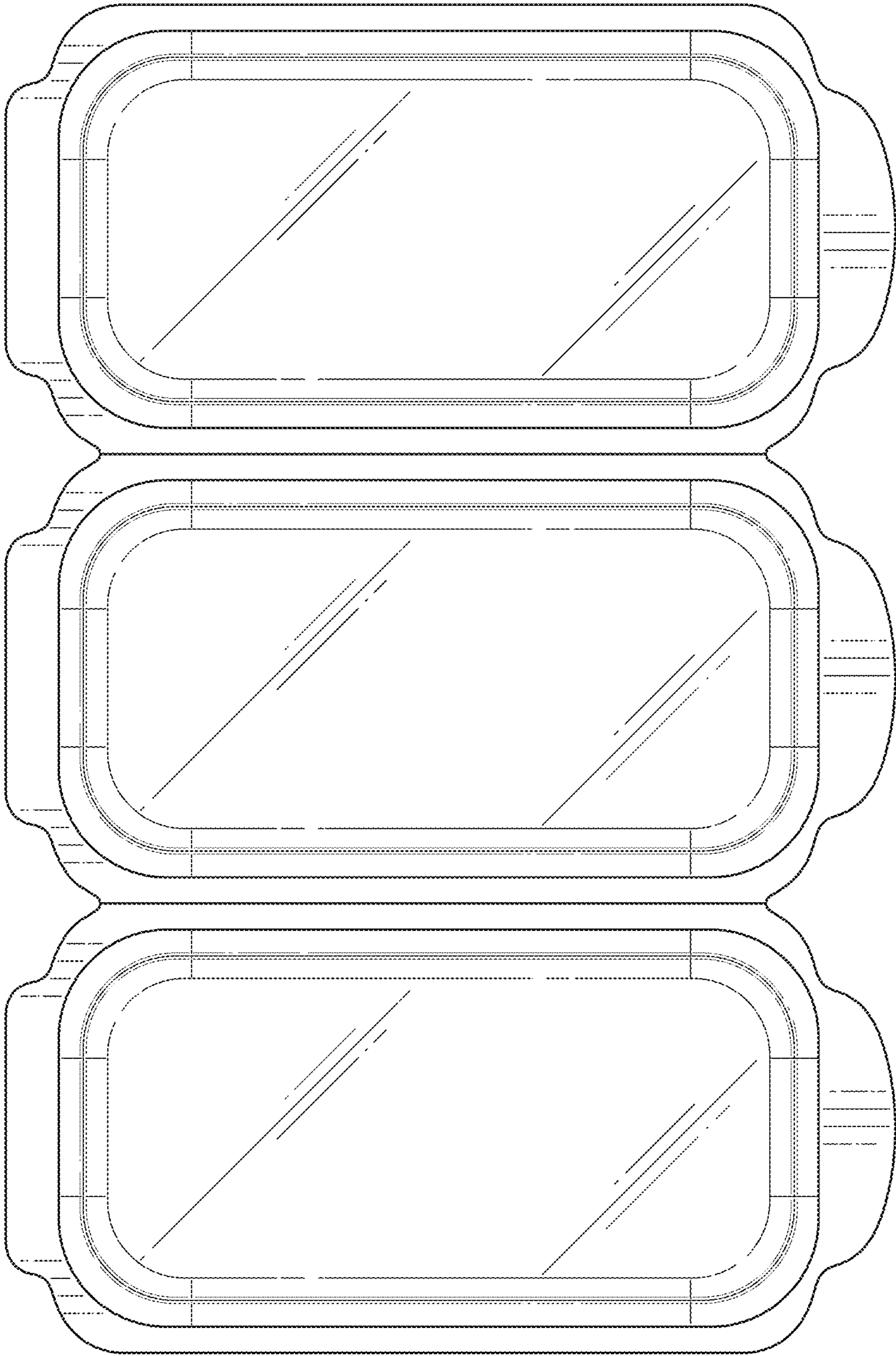

FIG. 5

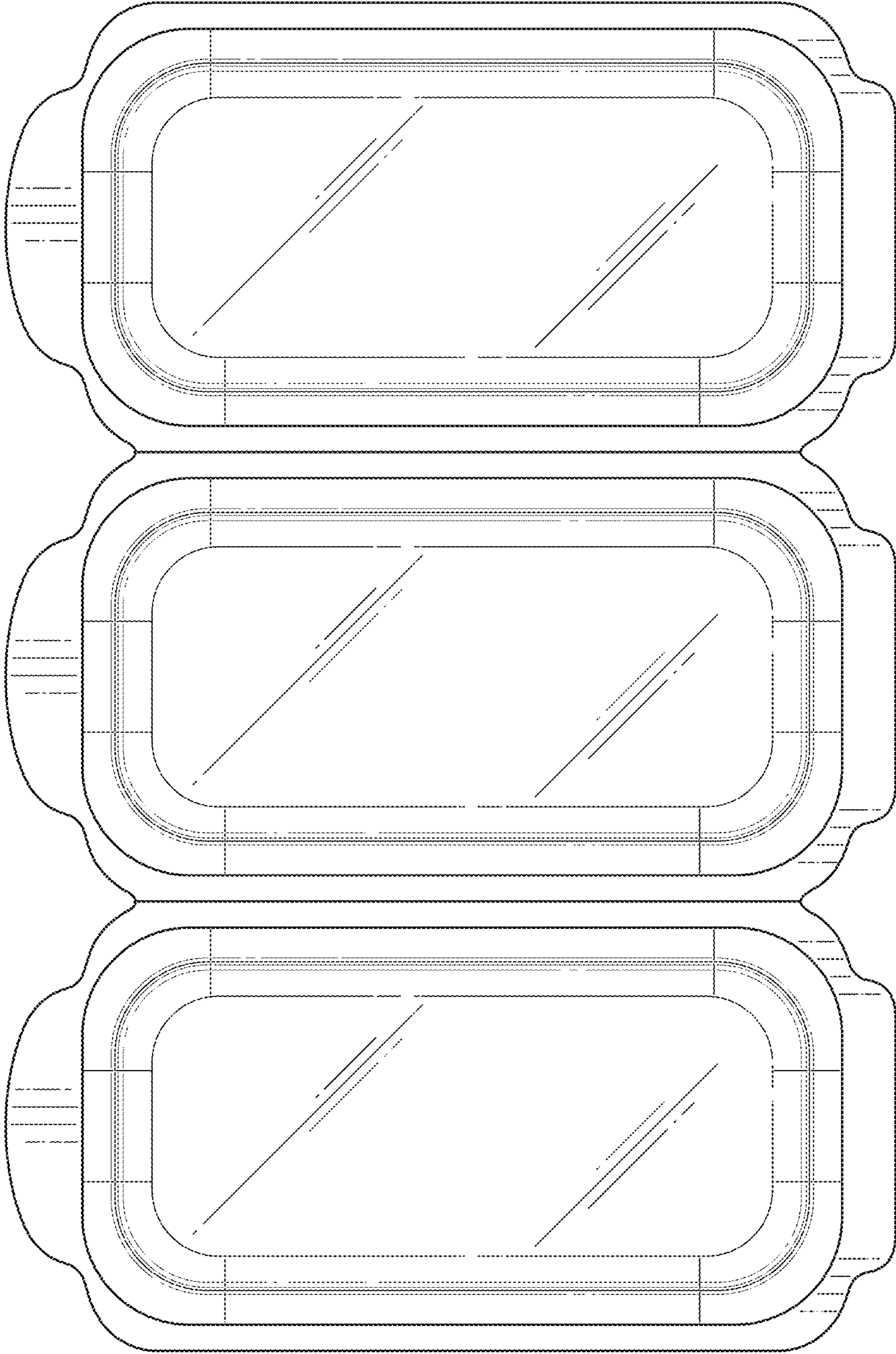

FIG. 6