



US00D891191S

(12) **United States Design Patent** (10) **Patent No.:** **US D891,191 S**
Binyk (45) **Date of Patent:** **** Jul. 28, 2020**

(54) **FOOD CONTAINER**
(71) Applicant: **Anastasiia Binyk**, Brovary (UA)
(72) Inventor: **Anastasiia Binyk**, Brovary (UA)
(**) Term: **15 Years**
(21) Appl. No.: **29/688,463**
(22) Filed: **Apr. 22, 2019**
(51) **LOC (12) Cl.** **07-07**
(52) **U.S. Cl.**
USPC **D7/602**
(58) **Field of Classification Search**
USPC D7/602, 605, 612, 615, 629, 630;
D9/549, 737, 738, 761, 516
CPC B65D 21/00; B65D 21/02; B65D 21/0212;
B65D 21/0209; B65D 13/00; B65D
43/00; B65D 43/02
See application file for complete search history.

D740,076 S 10/2015 Hwang
D741,169 S * 10/2015 Lutz D9/429
D741,708 S 10/2015 Thurin et al.
D791,586 S 7/2017 Bois
D821,159 S * 6/2018 Wahl D7/629
D823,683 S * 7/2018 Caldwell D9/435

* cited by examiner

Primary Examiner — Susan E Krakower
Assistant Examiner — Andrew Kerr
(74) *Attorney, Agent, or Firm* — Lawrence G. Fridman,
Esq.; Feigin & Fridman, LLC

(57) **CLAIM**

The ornamental design for a food container, as shown and described.

DESCRIPTION

FIG. 1 is a top perspective of a first embodiment a food container according to my new design;
FIG. 2 is a bottom perspective view thereof;
FIG. 3 is a side elevational view thereof;
FIG. 4 is a rear elevational view thereof;
FIG. 5 is a front elevational view thereof;
FIG. 6 is a top plan view thereof;
FIG. 7 is a bottom plan view thereof;
FIG. 8 is a top perspective view of a second embodiment a food container according to my new design;
FIG. 9 is bottom perspective view thereof;
FIG. 10 is a side elevational view thereof;
FIG. 11 is a rear elevational view thereof;
FIG. 12 is a front elevational view thereof;
FIG. 13 is a top plan view thereof; and,
FIG. 14 is a bottom plan view thereof.

1 Claim, 13 Drawing Sheets

(56) **References Cited**
U.S. PATENT DOCUMENTS
3,552,548 A * 1/1971 Wallestad B65D 25/10
206/710
3,578,467 A * 5/1971 Huber B65D 39/02
426/112
4,027,776 A 6/1977 Douglas
D367,589 S 3/1996 Zimmerman
D415,652 S * 10/1999 Loew D7/392.1
D419,394 S 1/2000 Wilson et al.
D482,934 S * 12/2003 Liu D7/602
D508,188 S 8/2005 Zettle et al.
D518,336 S * 4/2006 Hirani D7/629
D643,694 S * 8/2011 Lu D7/629

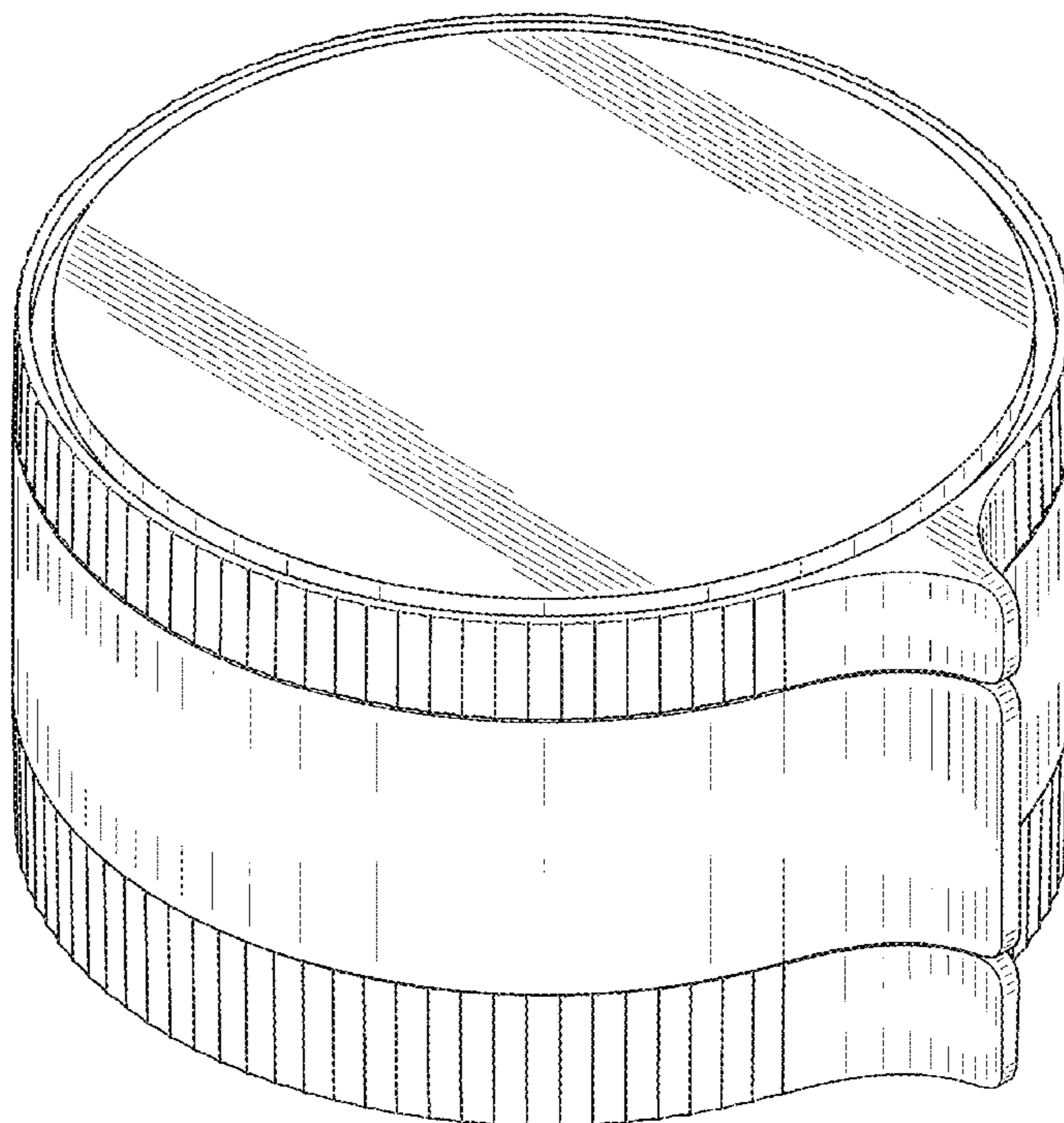

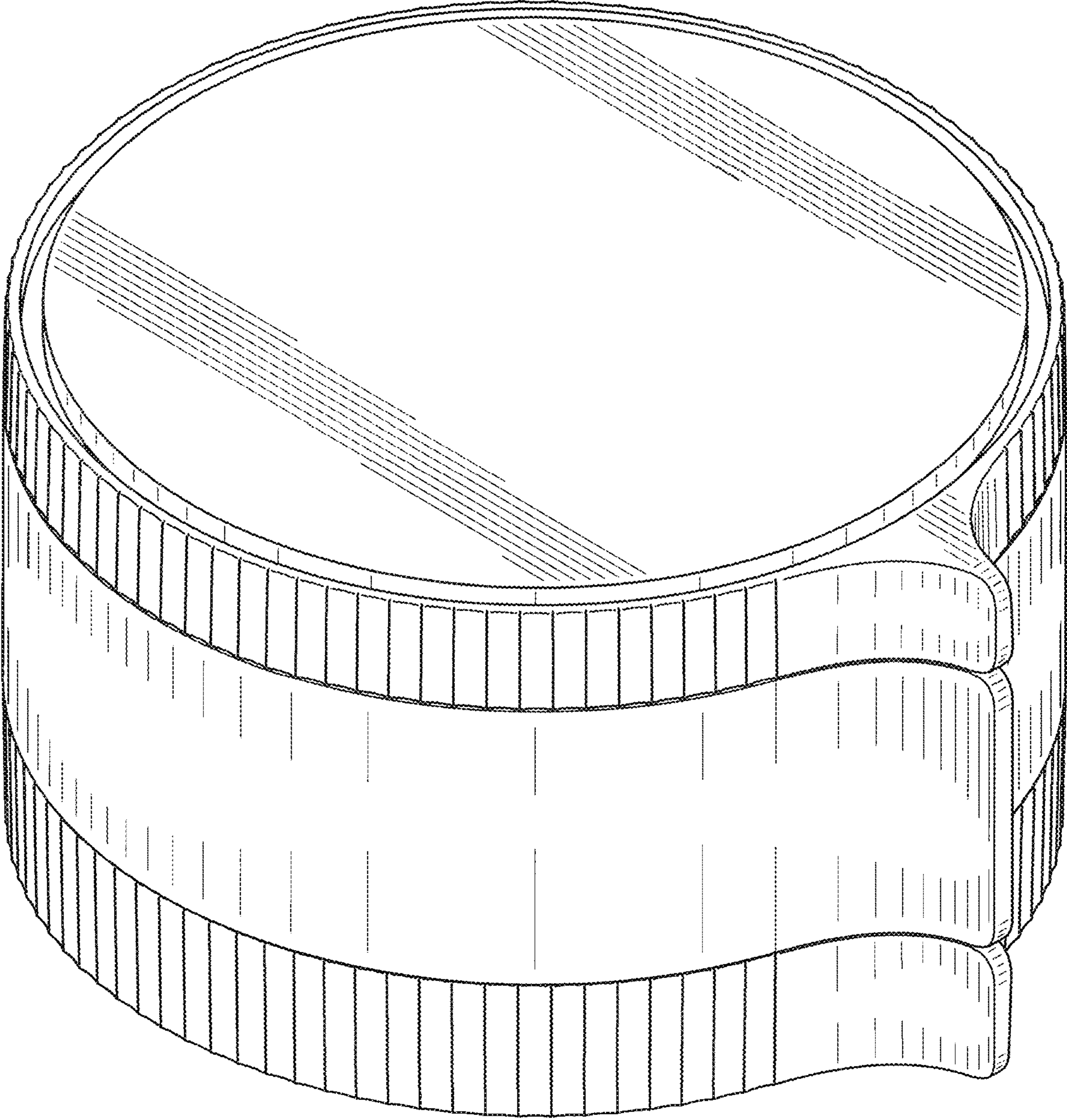

FIG. 1

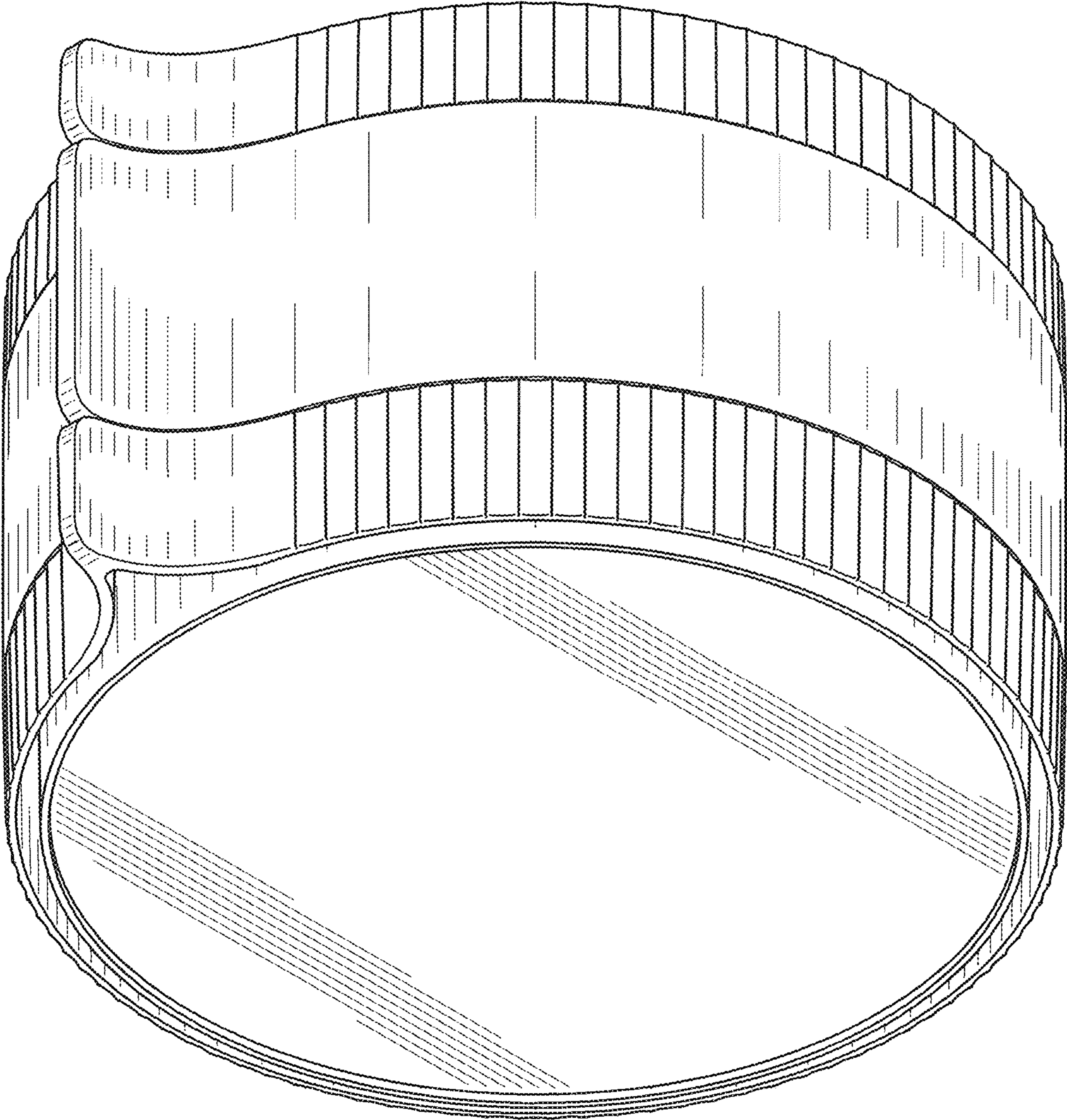

FIG. 2

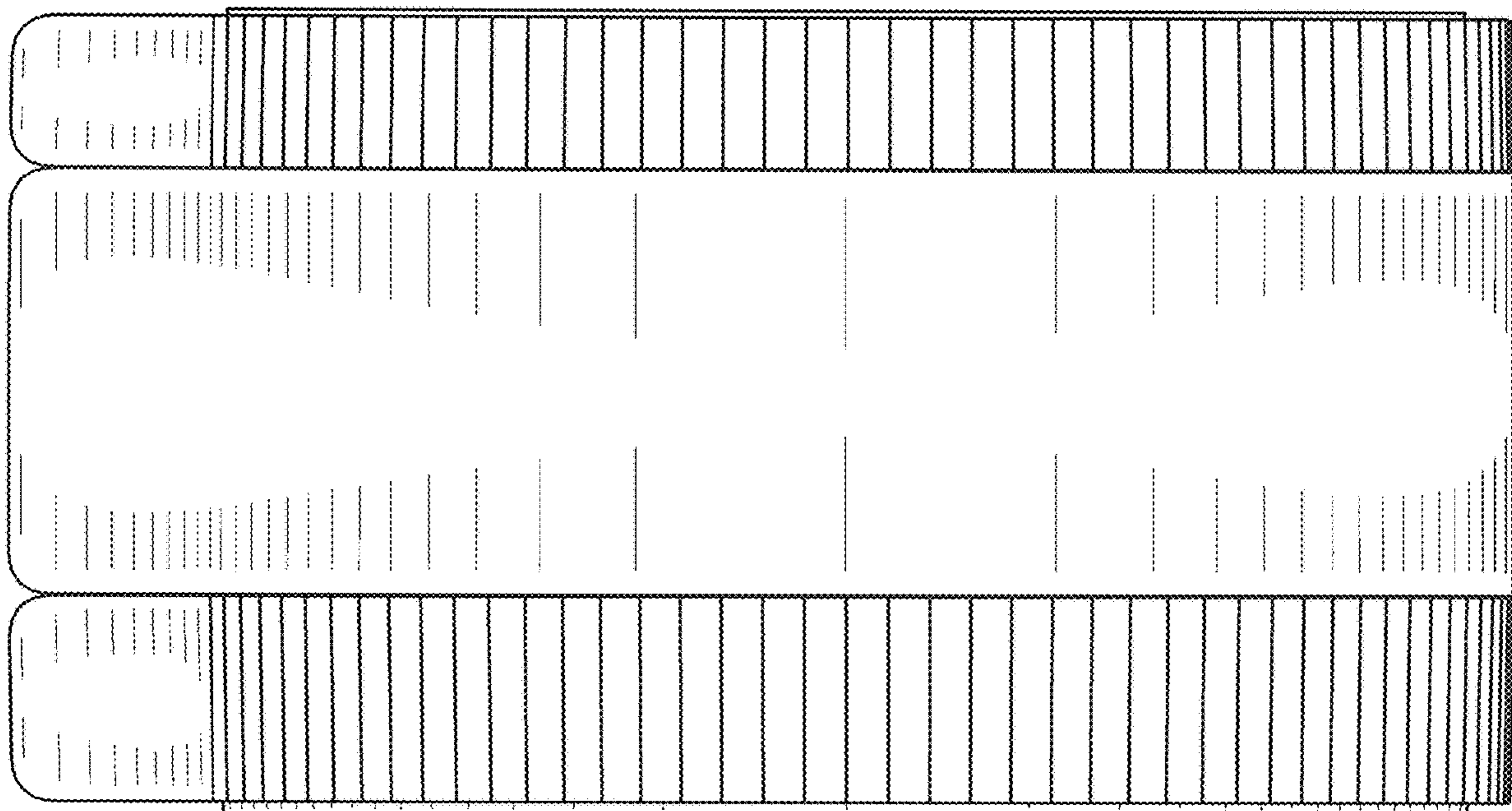

FIG. 3

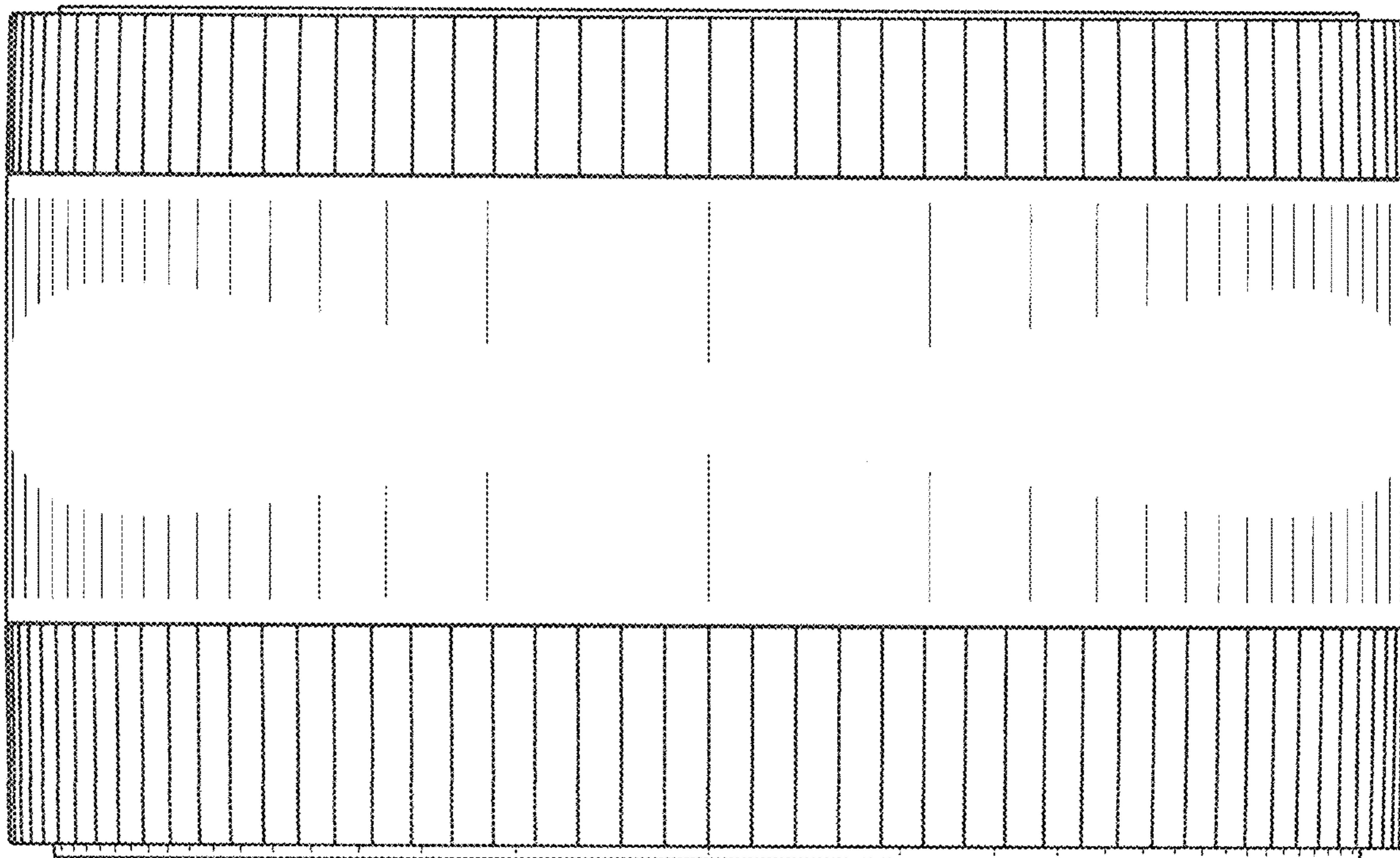

FIG. 4

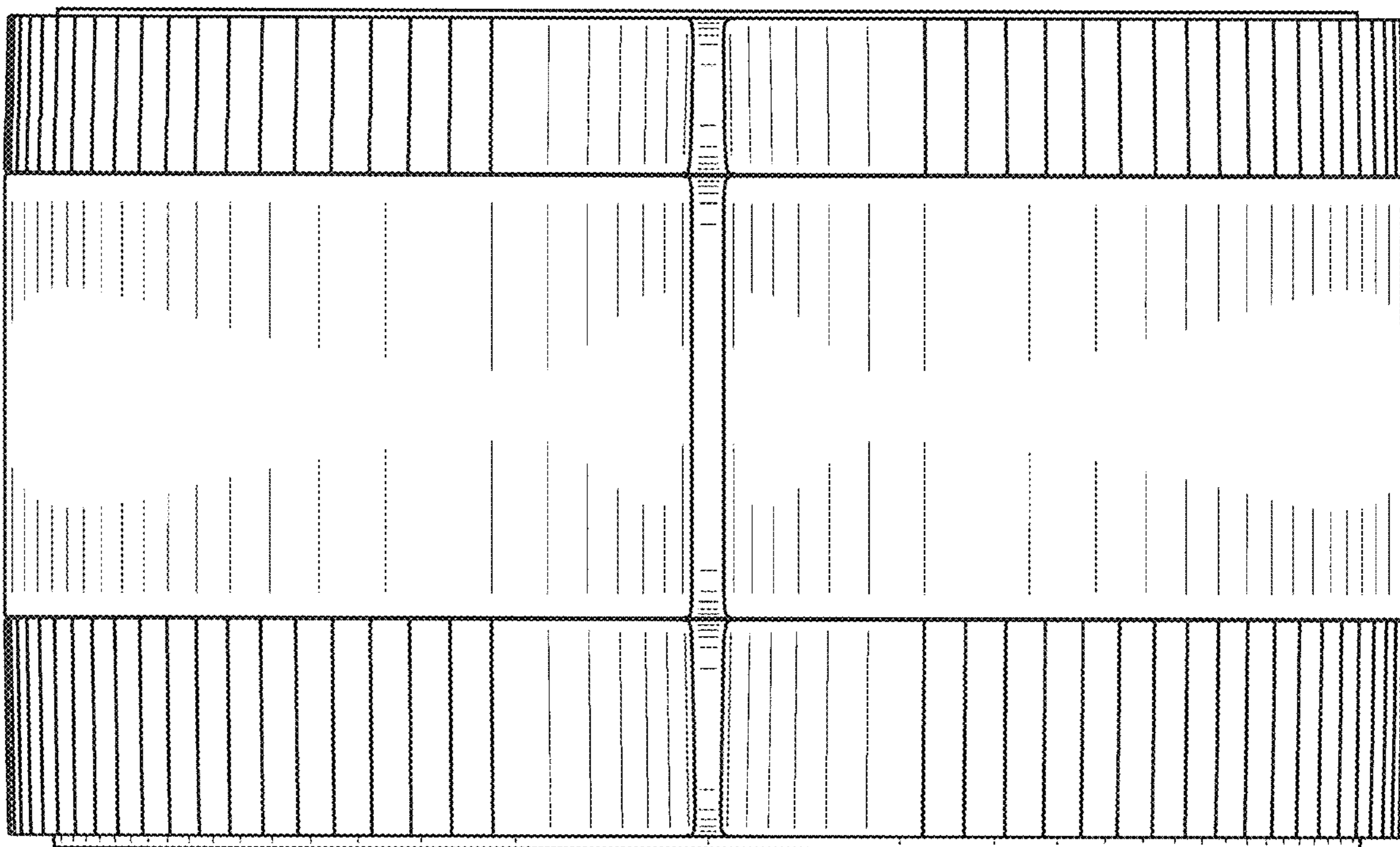

FIG. 5

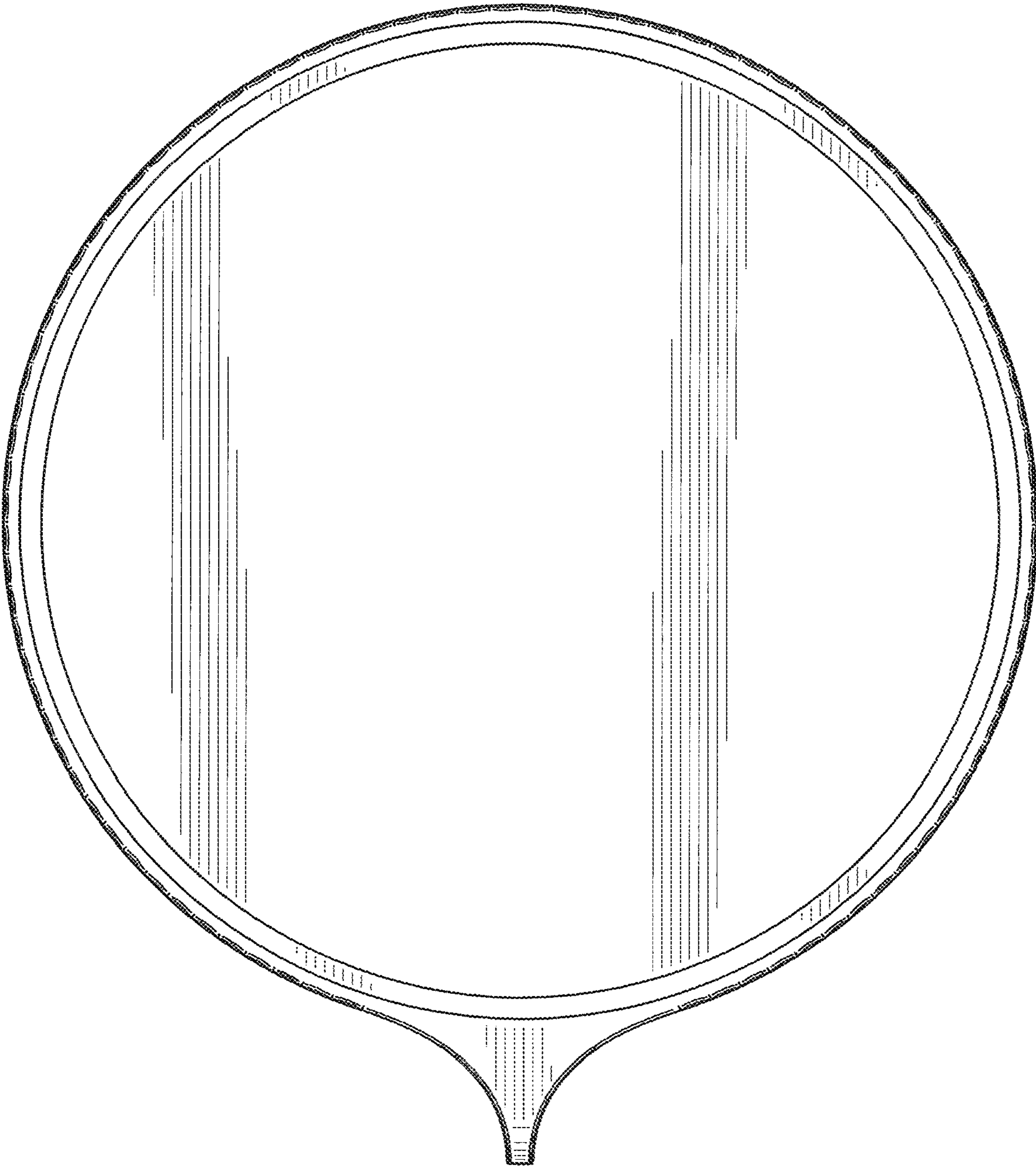

FIG. 6

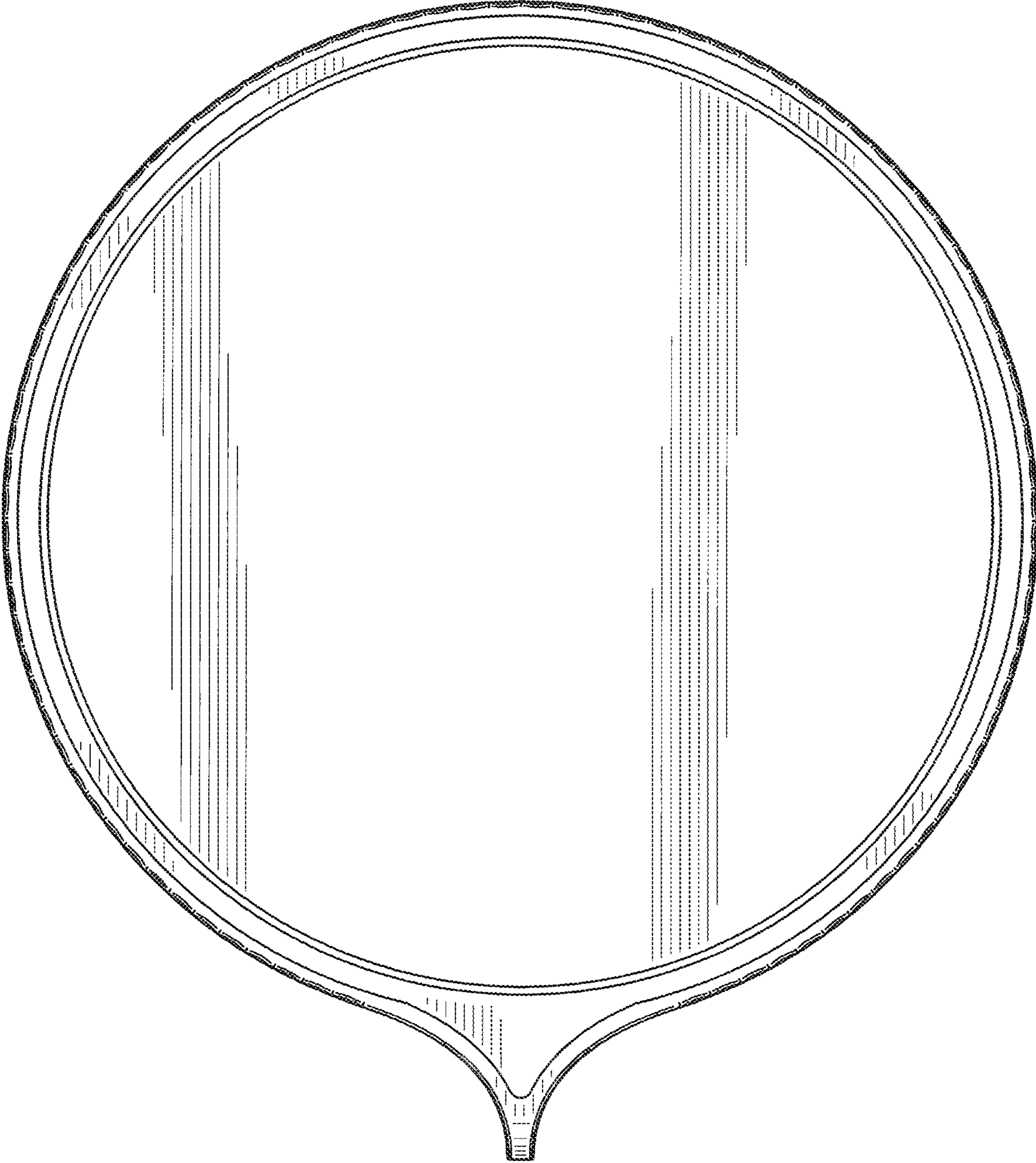

FIG. 7

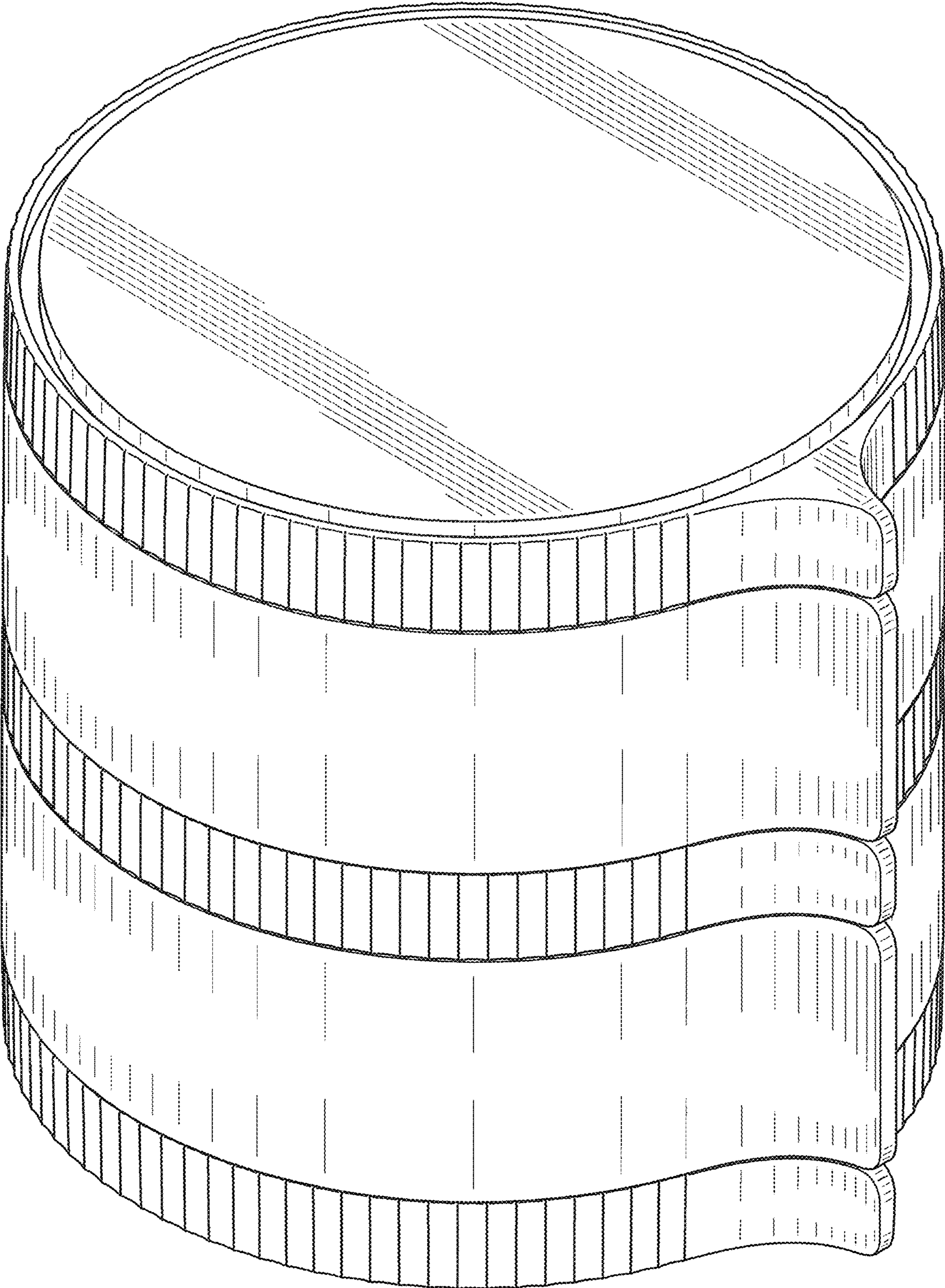

FIG. 8

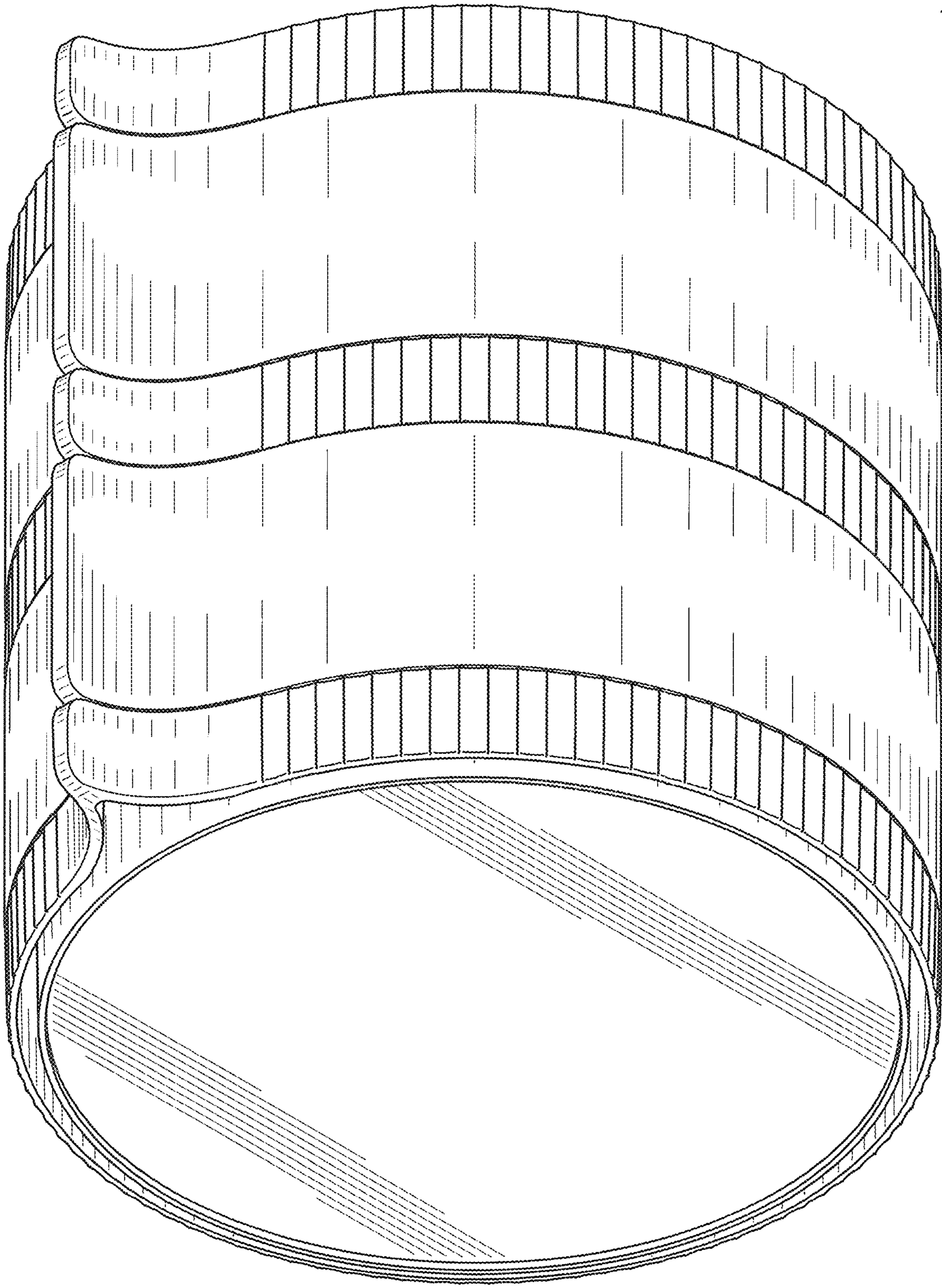

FIG. 9

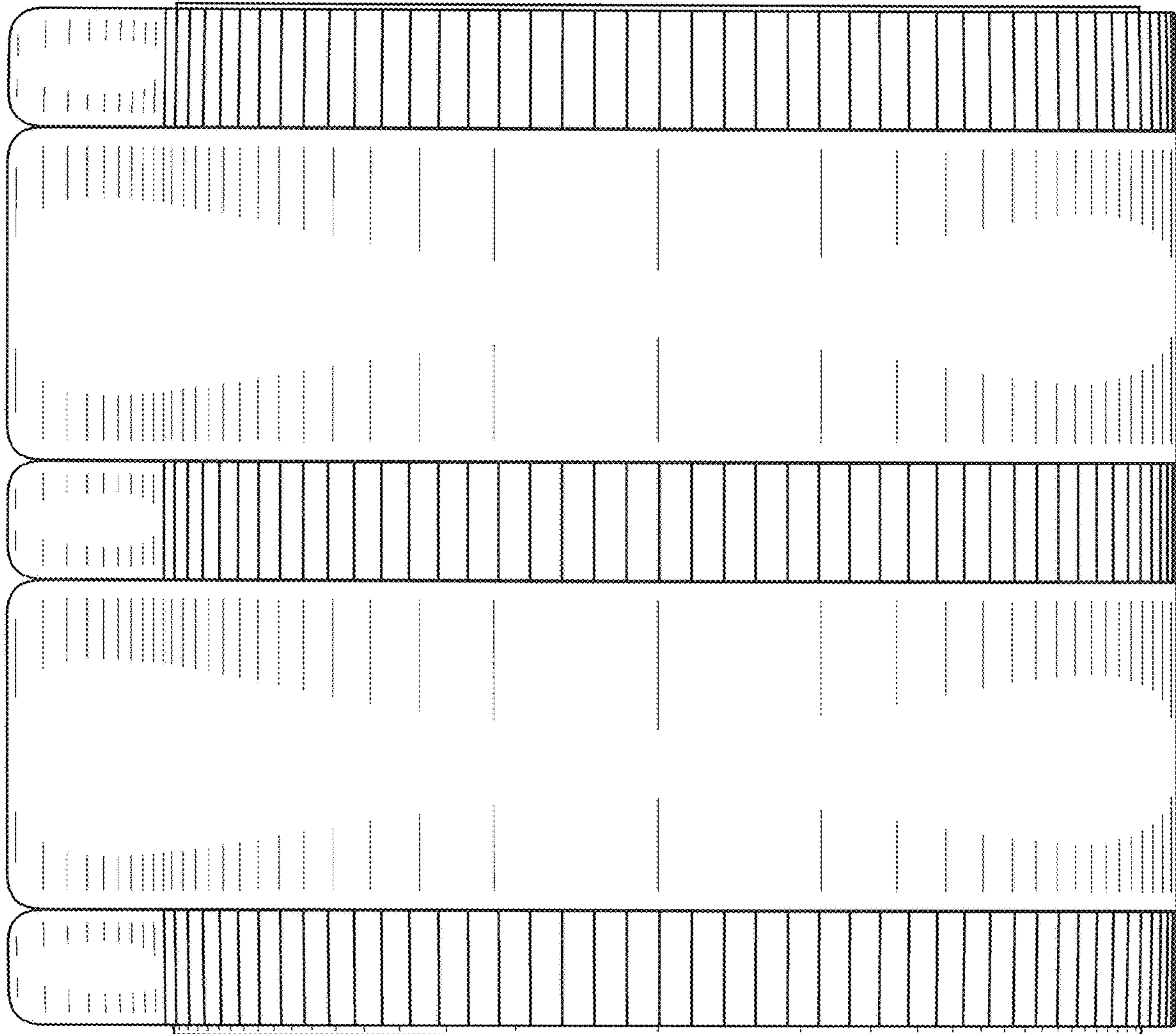

FIG. 10

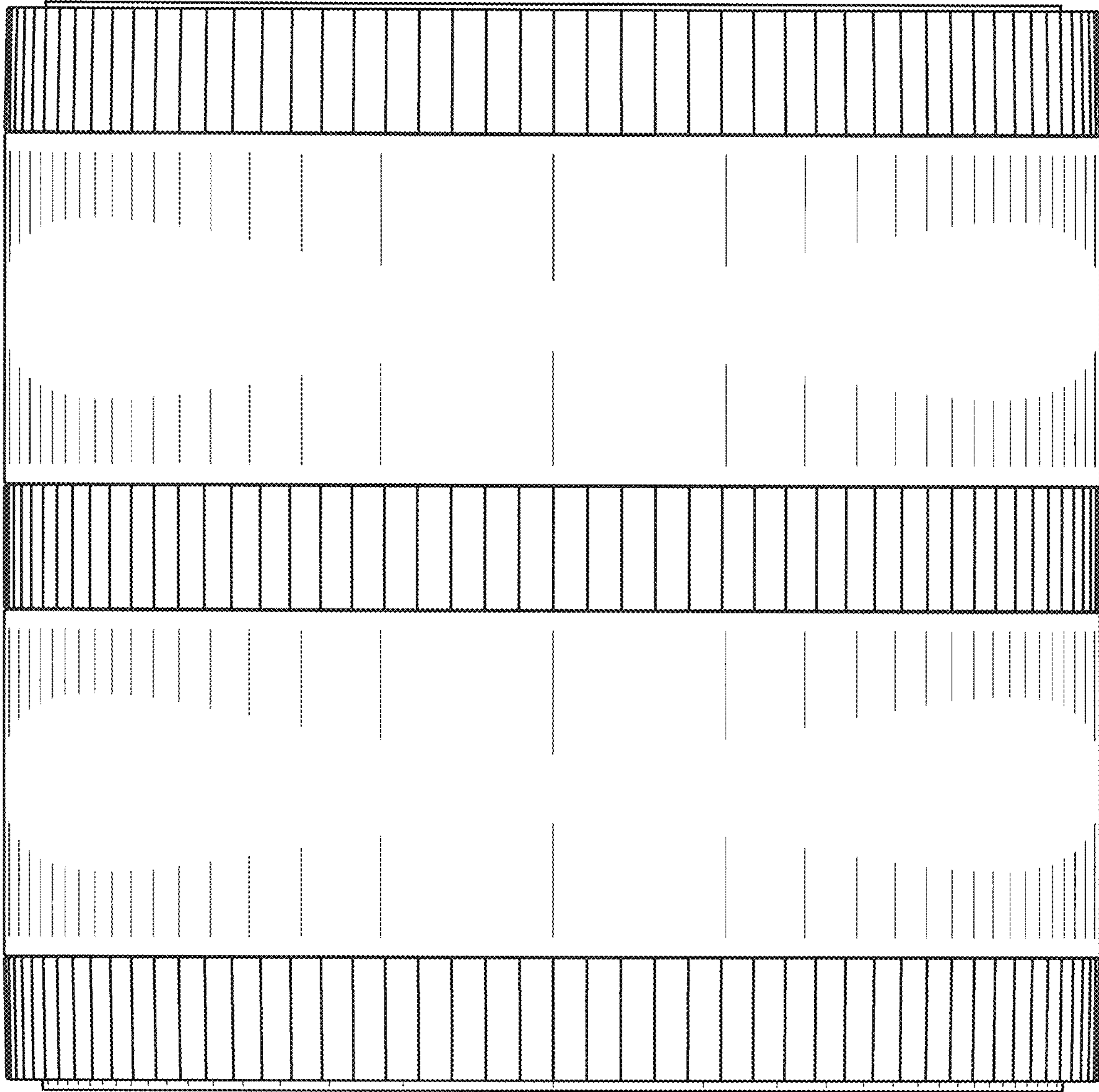

FIG. 11

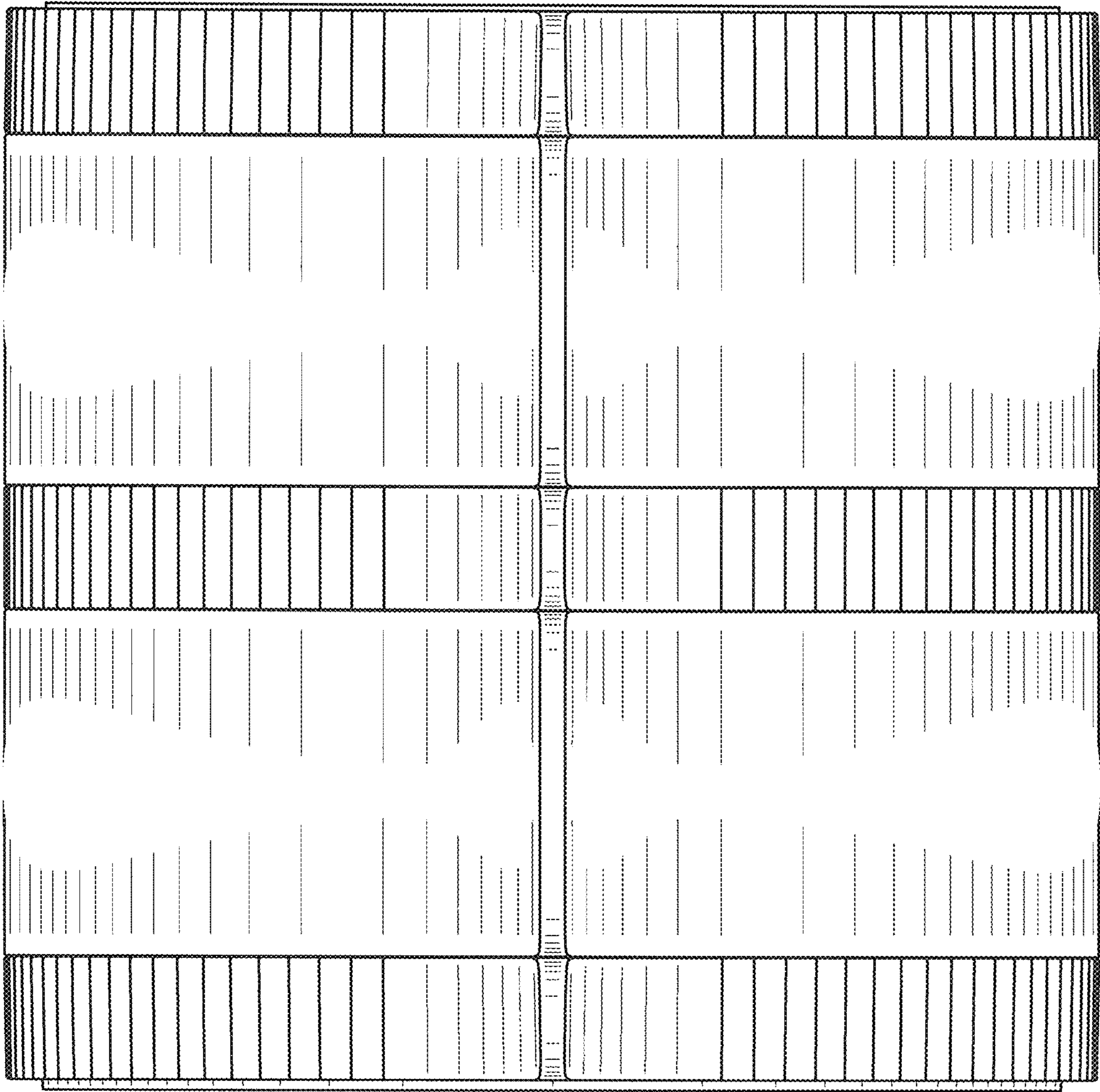

FIG. 12

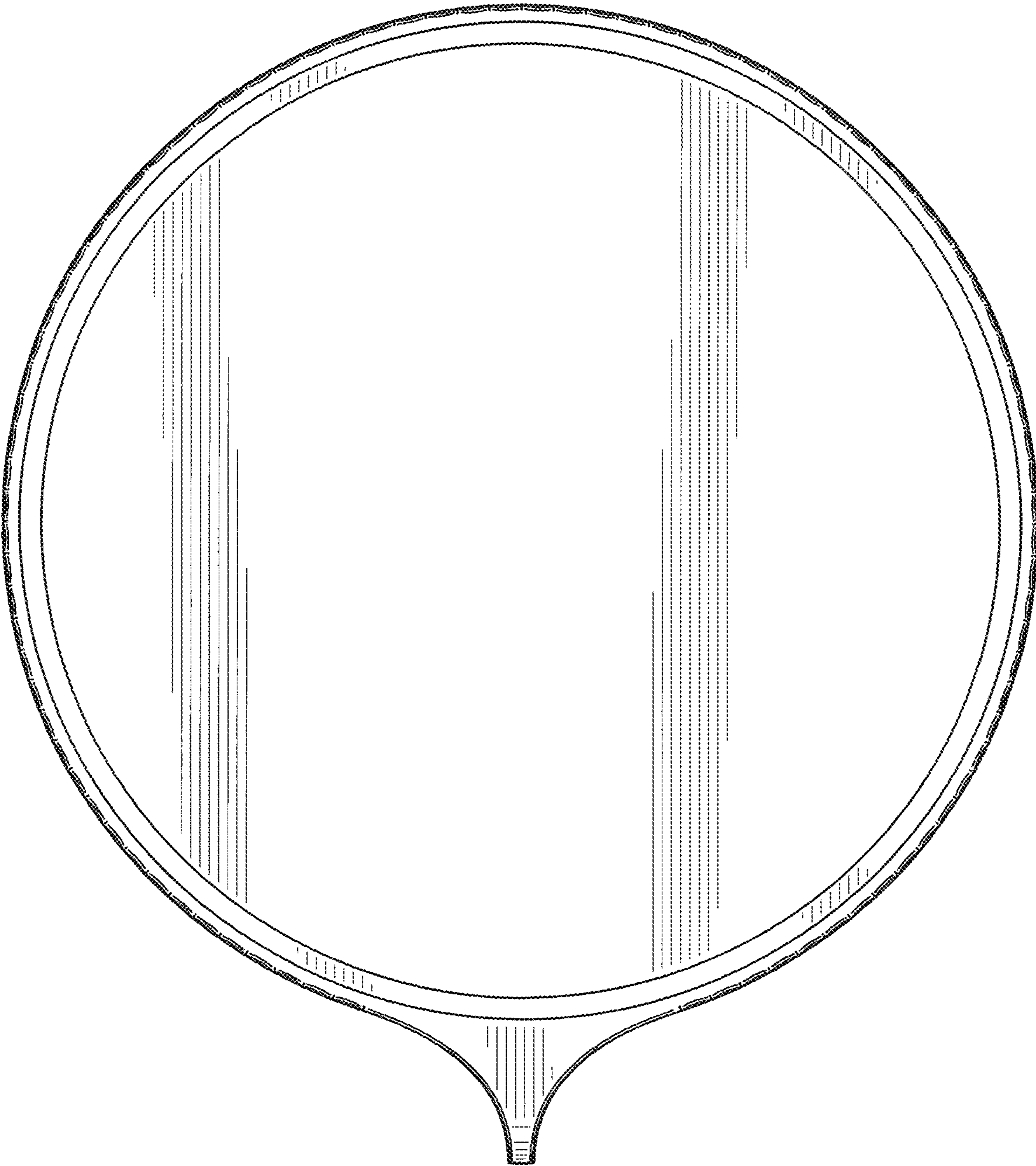

FIG. 13

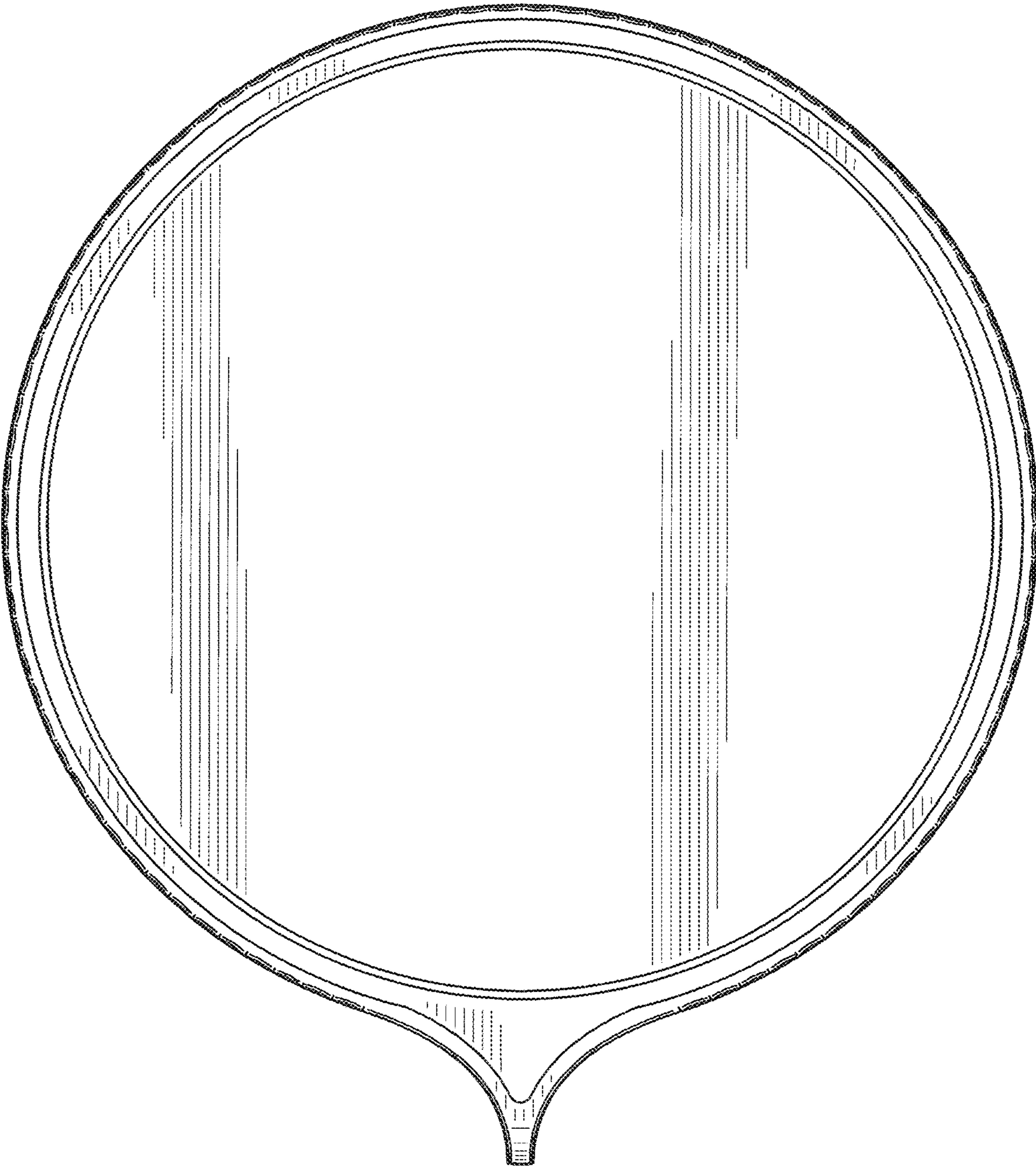

FIG. 14