



US00D891171S

(12) **United States Design Patent**
Papet et al.

(10) **Patent No.:** **US D891,171 S**
(45) **Date of Patent:** **** *Jul. 28, 2020**

(54) **PAN WITH HANDLE**

(71) Applicant: **OONI LIMITED**, Broxburn, West Lothian (GB)

(72) Inventors: **Pierre Papet**, West Lothian (GB);
Matti Kristian Tapaninaho, West Lothian (GB)

(73) Assignee: **OONI LIMITED**, Broxburn (GB)

(*) Notice: This patent is subject to a terminal disclaimer.

(**) Term: **15 Years**

(21) Appl. No.: **29/658,139**

(22) Filed: **Jul. 27, 2018**

(30) **Foreign Application Priority Data**

Jan. 30, 2018 (EM) 004685584-0001

Jan. 30, 2018 (EM) 004685584-0004

Jan. 30, 2018 (EM) 004685584-0005

(51) **LOC (12) Cl.** **07-02**

(52) **U.S. Cl.**
USPC **D7/360**; D7/354; D7/361

(58) **Field of Classification Search**
USPC D7/323, 354–363, 391, 393–396, 409;
D24/227

(Continued)

(56) **References Cited**

U.S. PATENT DOCUMENTS

D387,177 S * 12/1997 Davis D24/227

D434,265 S * 11/2000 Tatlow D7/323

(Continued)

Primary Examiner — Ricky Pham

(74) *Attorney, Agent, or Firm* — Ferguson Case Orr Paterson LLP

(57) **CLAIM**

The ornamental design for a pan with handle, as shown and described herein.

DESCRIPTION

FIG. 1 is a top perspective view of a pan and handle in a connected configuration.

FIGS. 2a and 2b are top perspective views of the pan and handle, respectively, in a disconnected configuration.

FIG. 3 is left side elevation view of the pan and handle in the connected configuration, with the right side elevation view being a mirror image.

FIG. 4 is a bottom perspective view of the pan and handle in the connected configuration.

FIGS. 5a and 5b are bottom perspective views of the pan and handle in the disconnected configuration.

FIG. 6 is a top plan view of the pan and handle in the connected configuration.

FIG. 7 is a bottom plan view of the pan and handle in the connected configuration.

FIG. 8 is a magnified top perspective view of the handle in the disconnected configuration.

FIG. 9 is a magnified bottom perspective view of the handle in the disconnected configuration.

FIG. 10 is a magnified front elevation view of the handle in the disconnected configuration.

FIG. 11 is a magnified rear elevation view of the handle in the disconnected configuration.

FIG. 12 is a magnified left side elevation view of the handle in the disconnected configuration, with the right side elevation view being a mirror image.

FIG. 13 is a magnified top plan view of the handle in the disconnected configuration.

FIG. 14 is a magnified bottom plan view of the handle in the disconnected configuration.

FIG. 15 is a top perspective view of the pan in the disconnected configuration.

FIG. 16 is a front elevation view of the pan in the disconnected configuration, with the rear elevation view being identical.

FIG. 17 is right side elevation view of the pan in the disconnected configuration, with the left side elevation view being identical.

(Continued)

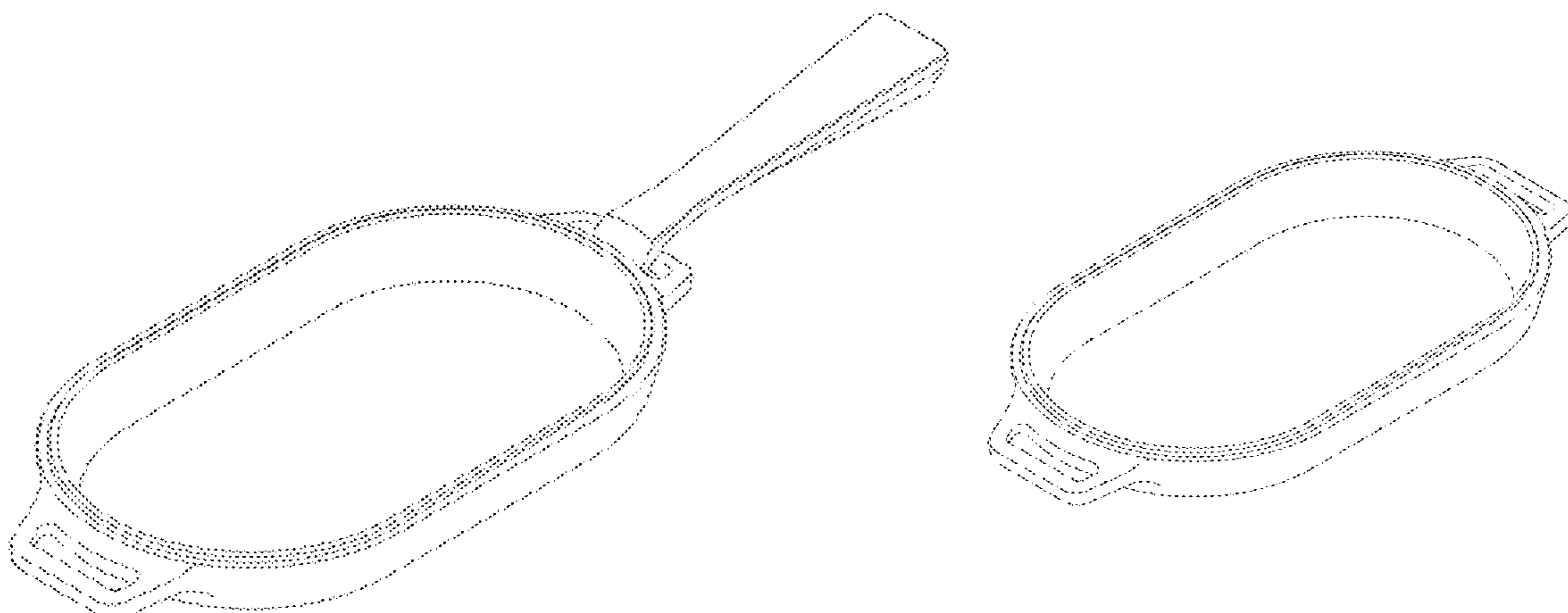

FIG. 18 is a top plan view of the pan in the disconnected configuration.

FIG. 19 is a bottom plan view of the pan in the disconnected configuration; and,

FIG. 20 is a bottom perspective view of the pan in the disconnected configuration.

1 Claim, 14 Drawing Sheets

(58) **Field of Classification Search**

CPC A47G 19/12; A47J 27/00; A47J 27/002;
A47J 27/08; A47J 27/21; A47J 27/58;
A47J 36/025; A47J 36/06; A47J 36/12;
A47J 37/00; A47J 37/10; A47J 37/101;
A47J 37/103; A47J 37/12; A47J 37/1204;
A47J 45/061; A47J 45/071; A47J 45/08;
H05B 6/12

See application file for complete search history.

(56)

References Cited

U.S. PATENT DOCUMENTS

D458,797	S	*	6/2002	Kellermann	D7/360
D555,419	S	*	11/2007	Reckert	D7/361
D580,214	S	*	11/2008	Dodane	D7/361
D594,271	S	*	6/2009	Bodum	D7/361
D621,652	S	*	8/2010	Dodane	D7/354
D657,992	S	*	4/2012	Moodie	D7/354
D696,057	S	*	12/2013	Green	D7/354
D697,751	S	*	1/2014	Schleinker	D7/354
D732,335	S	*	6/2015	Thonis	D7/354
D788,518	S	*	6/2017	Aggarwal	D7/360
D815,884	S	*	4/2018	Freeman	D7/361

* cited by examiner

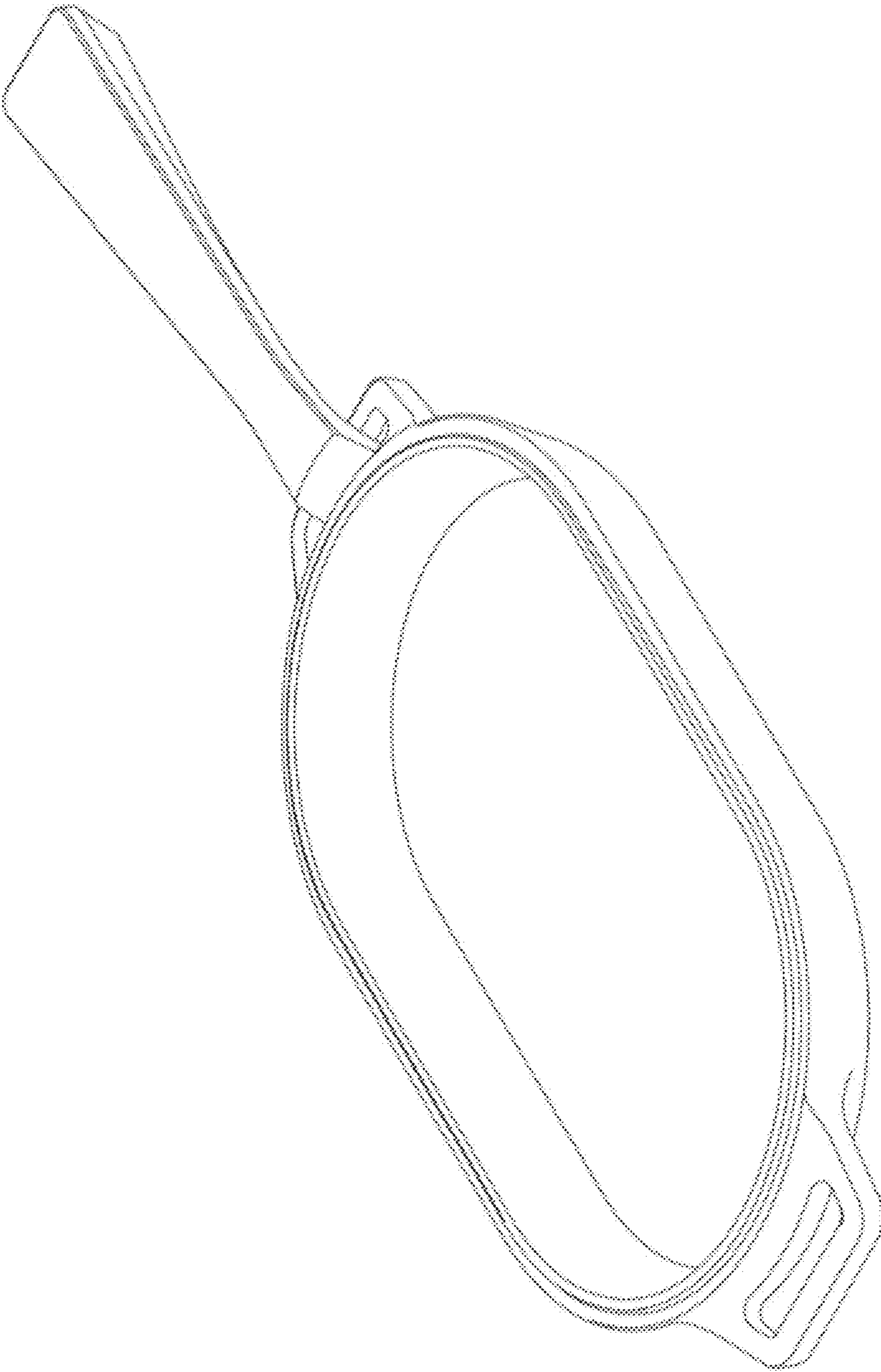

FIG. 1

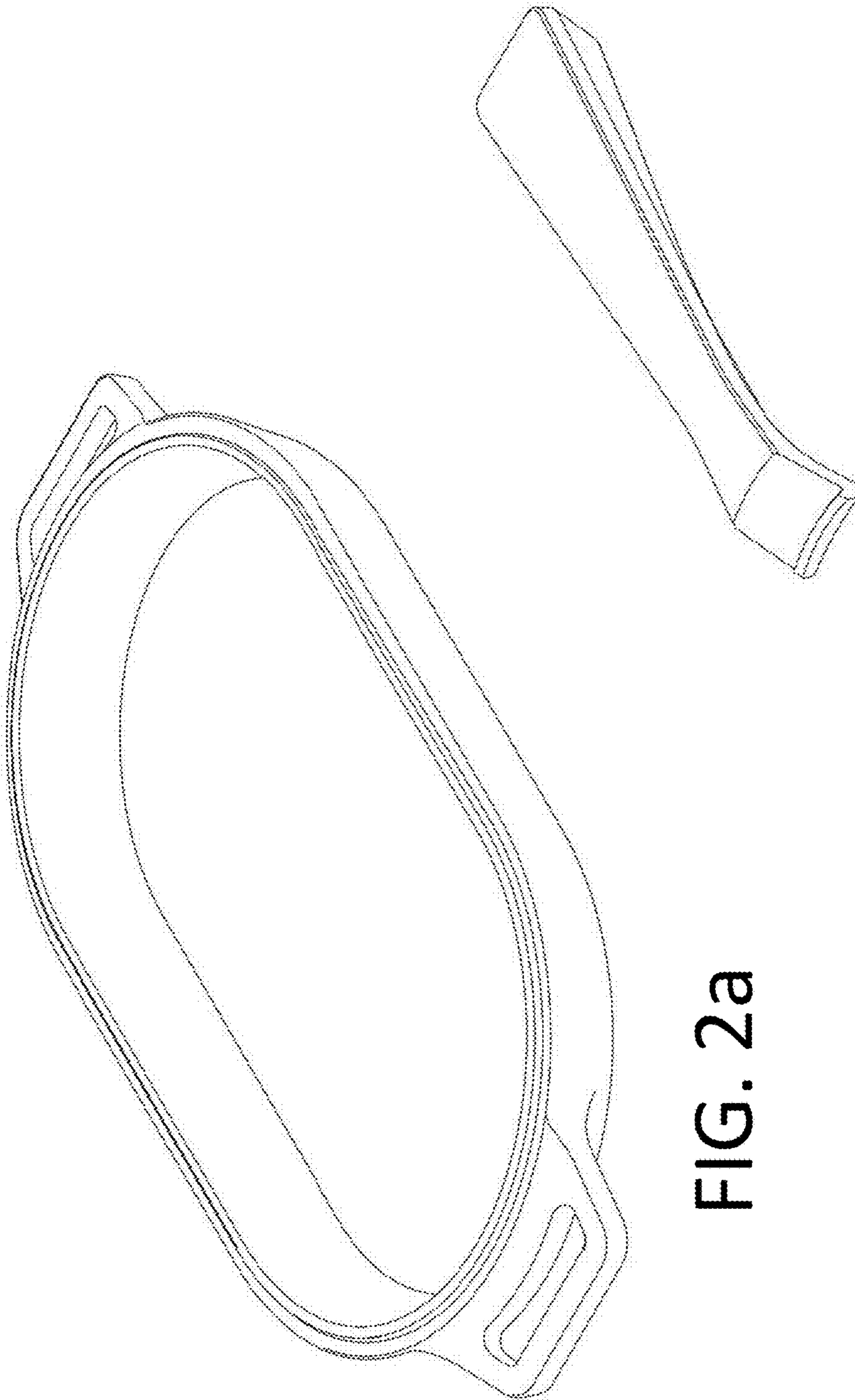

FIG. 2a

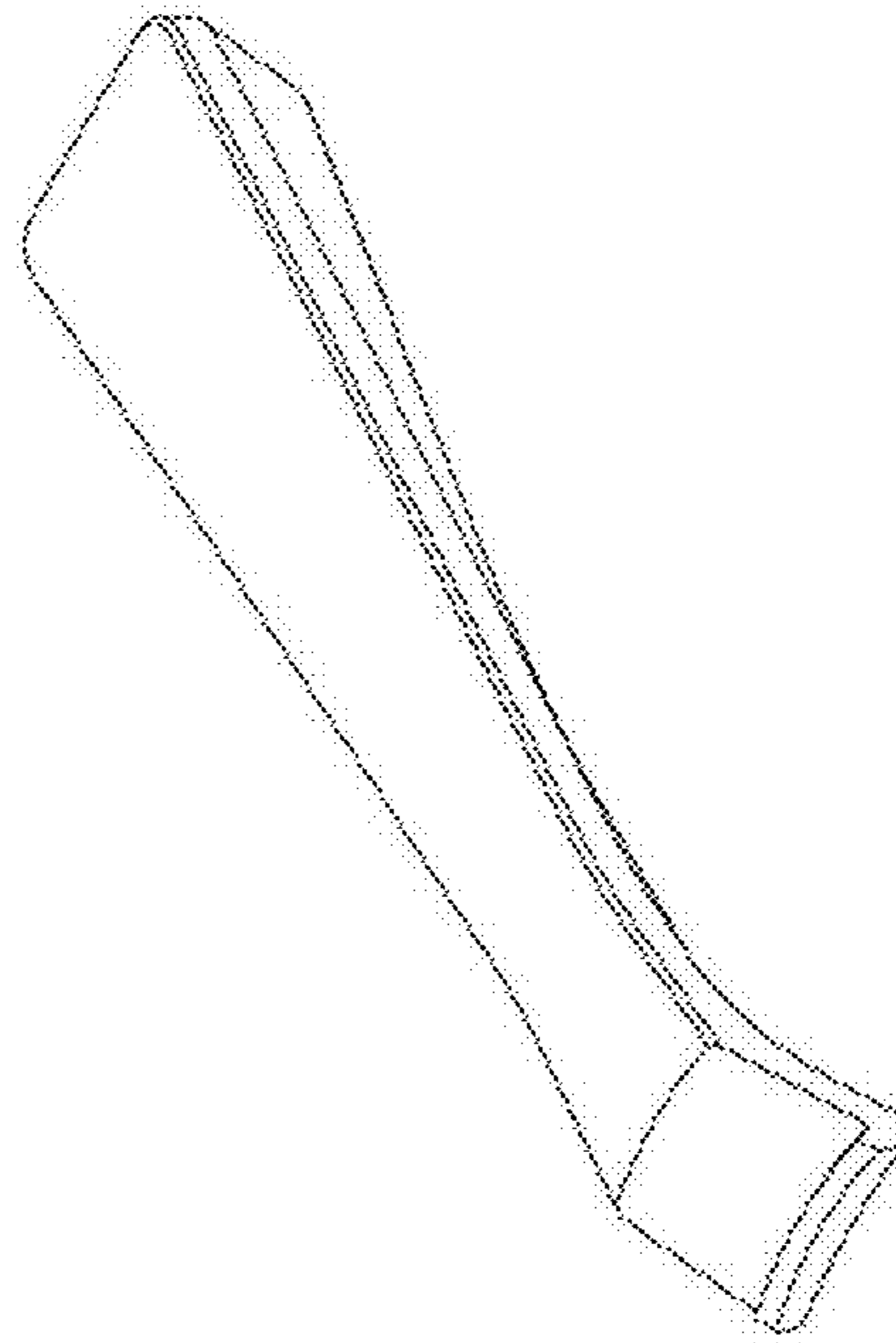

FIG. 2b

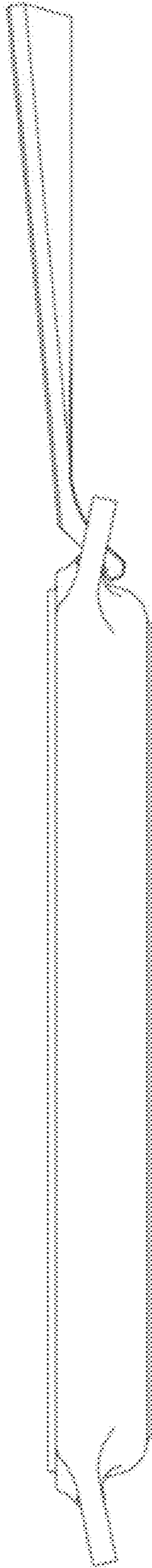

FIG. 3

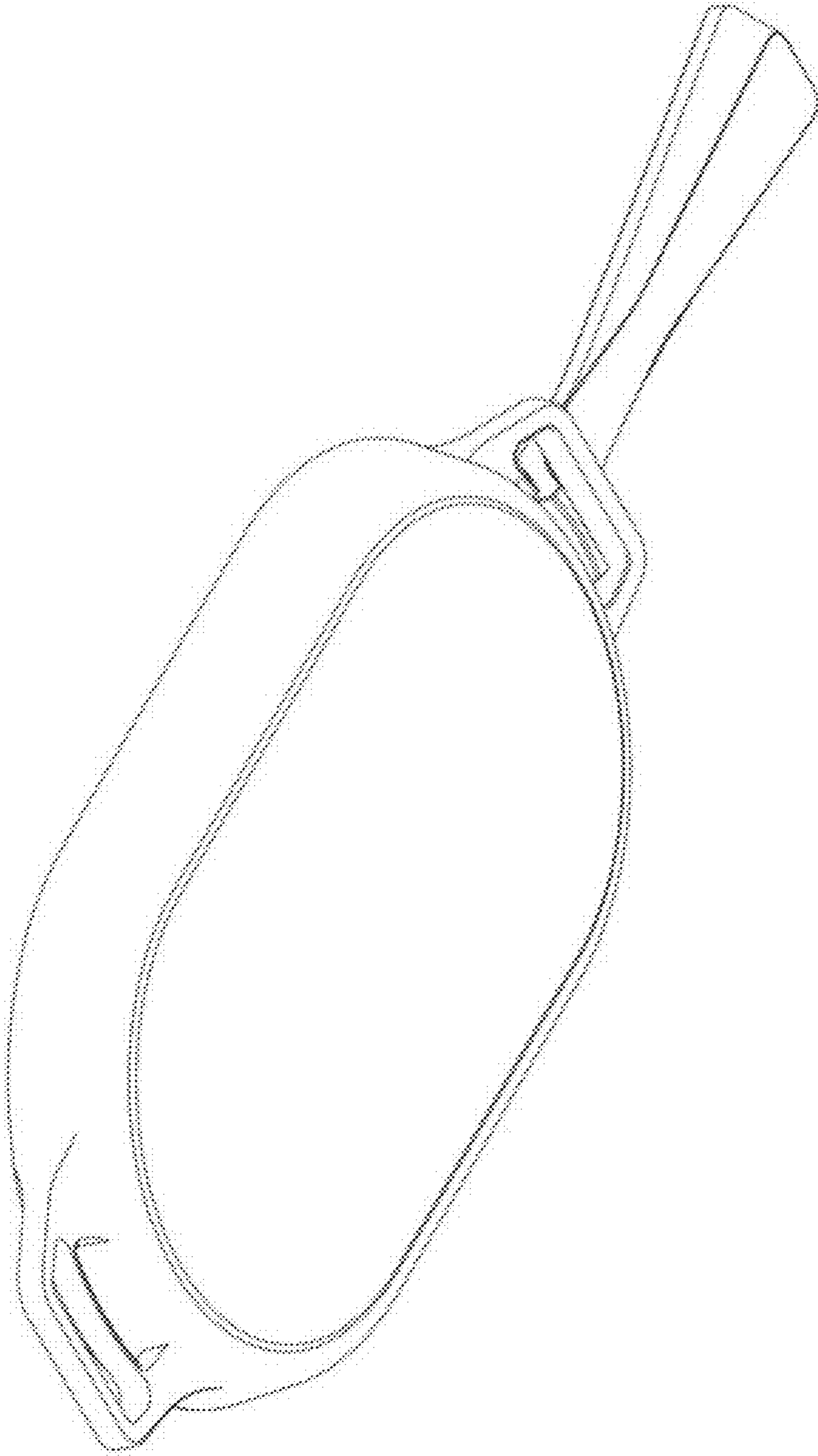

FIG. 4

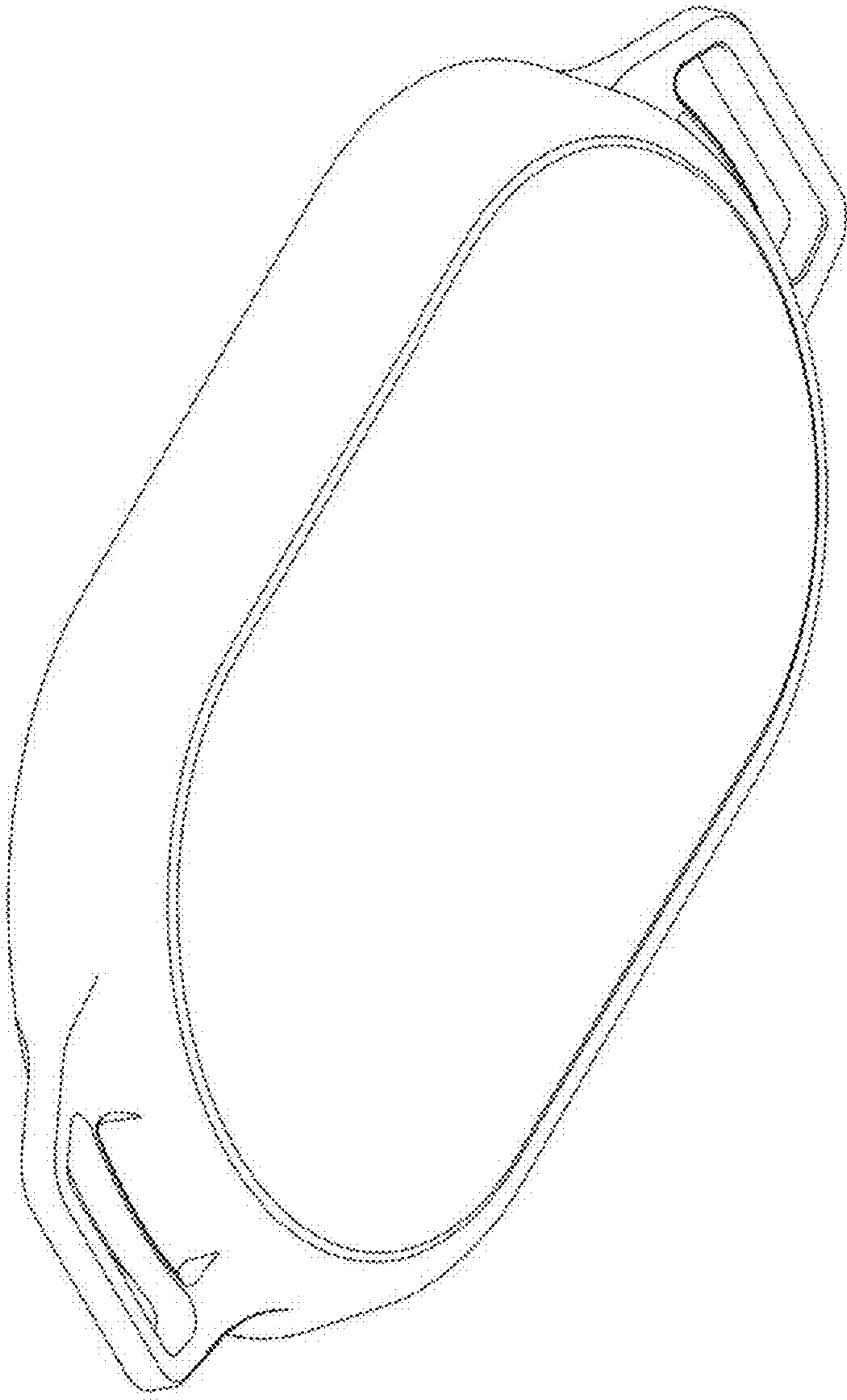

FIG. 5a

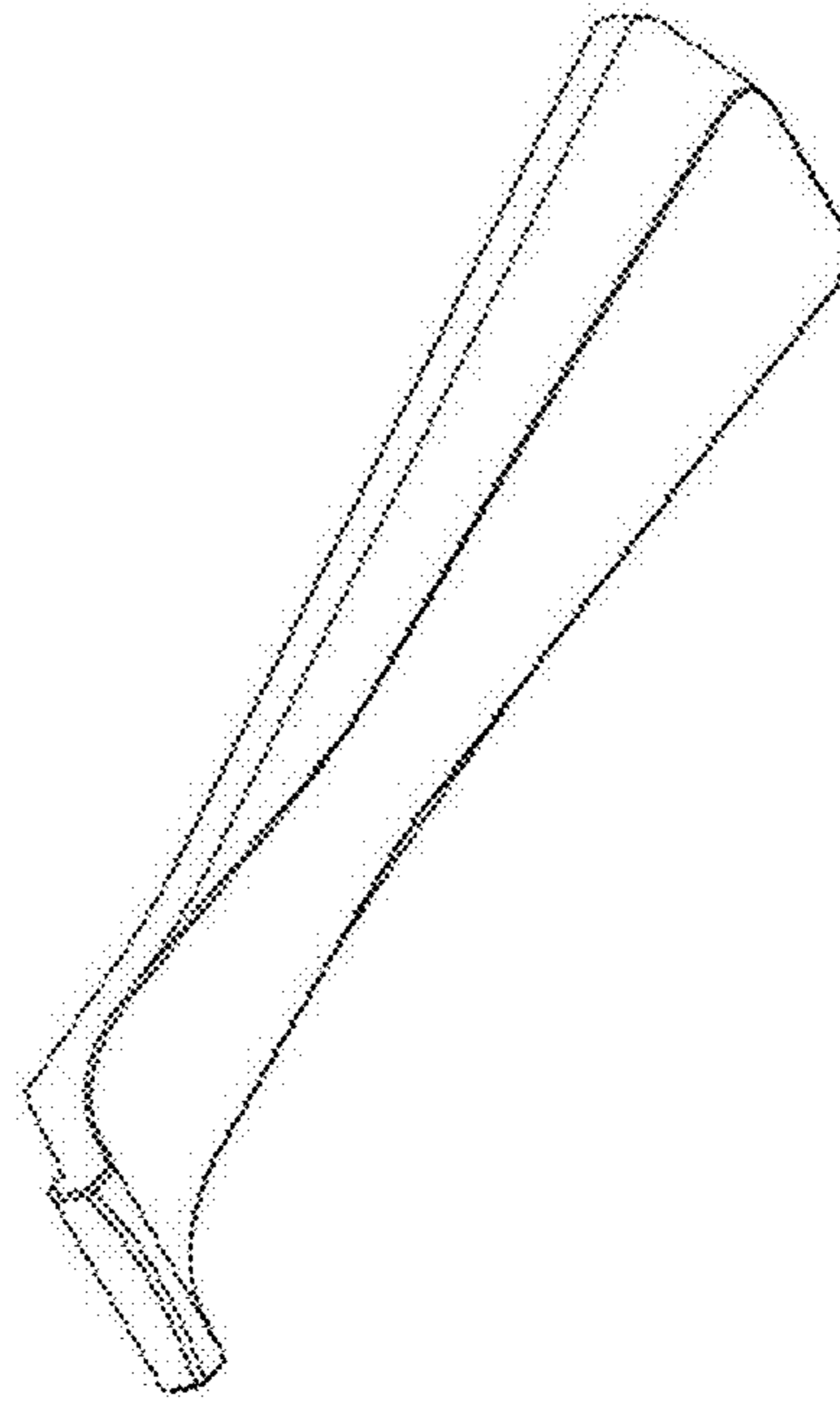

FIG. 5b

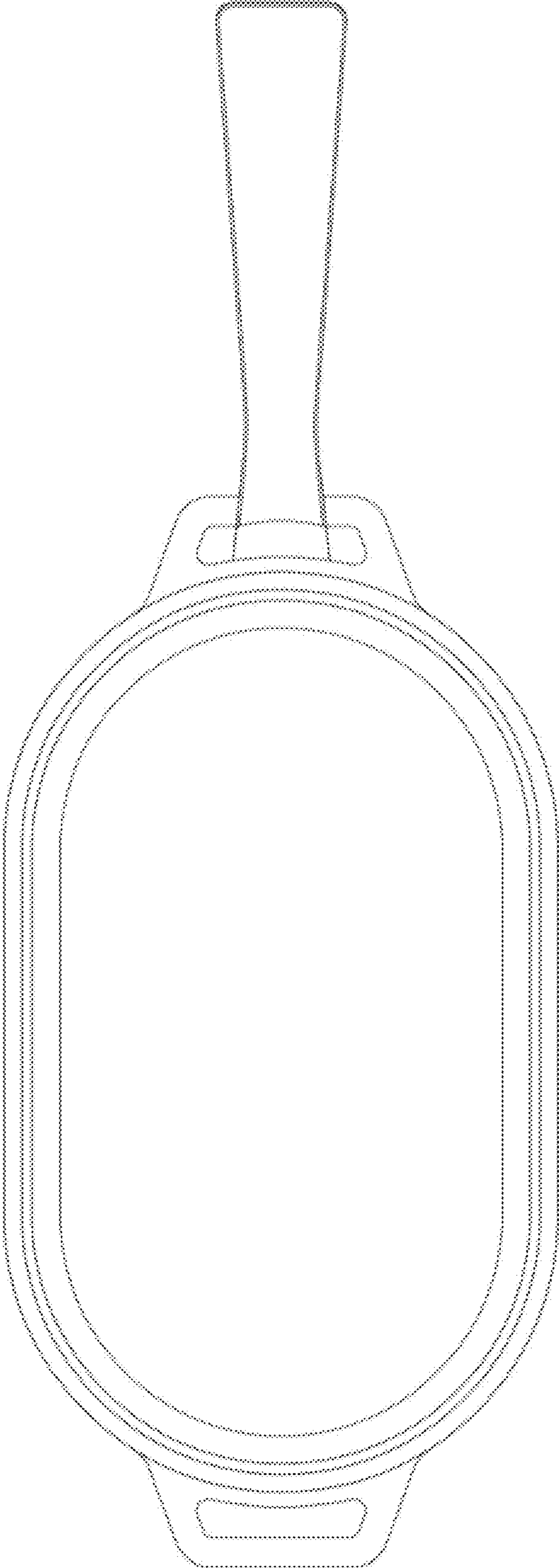

FIG. 6

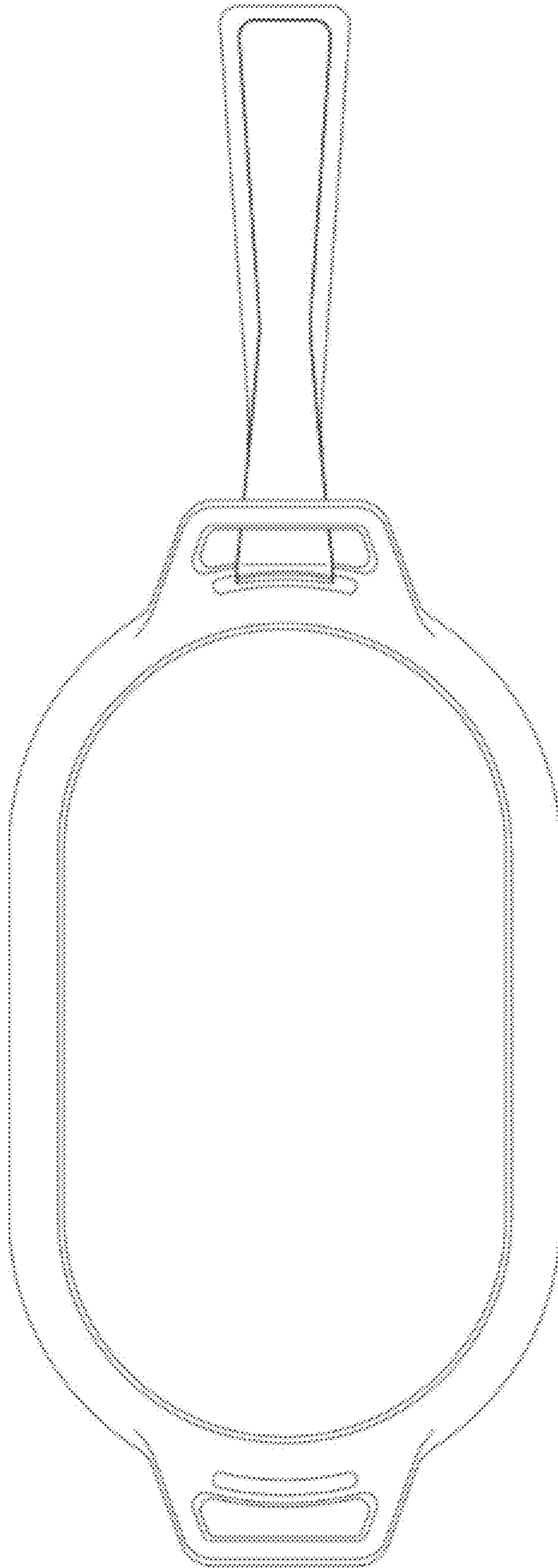

FIG. 7

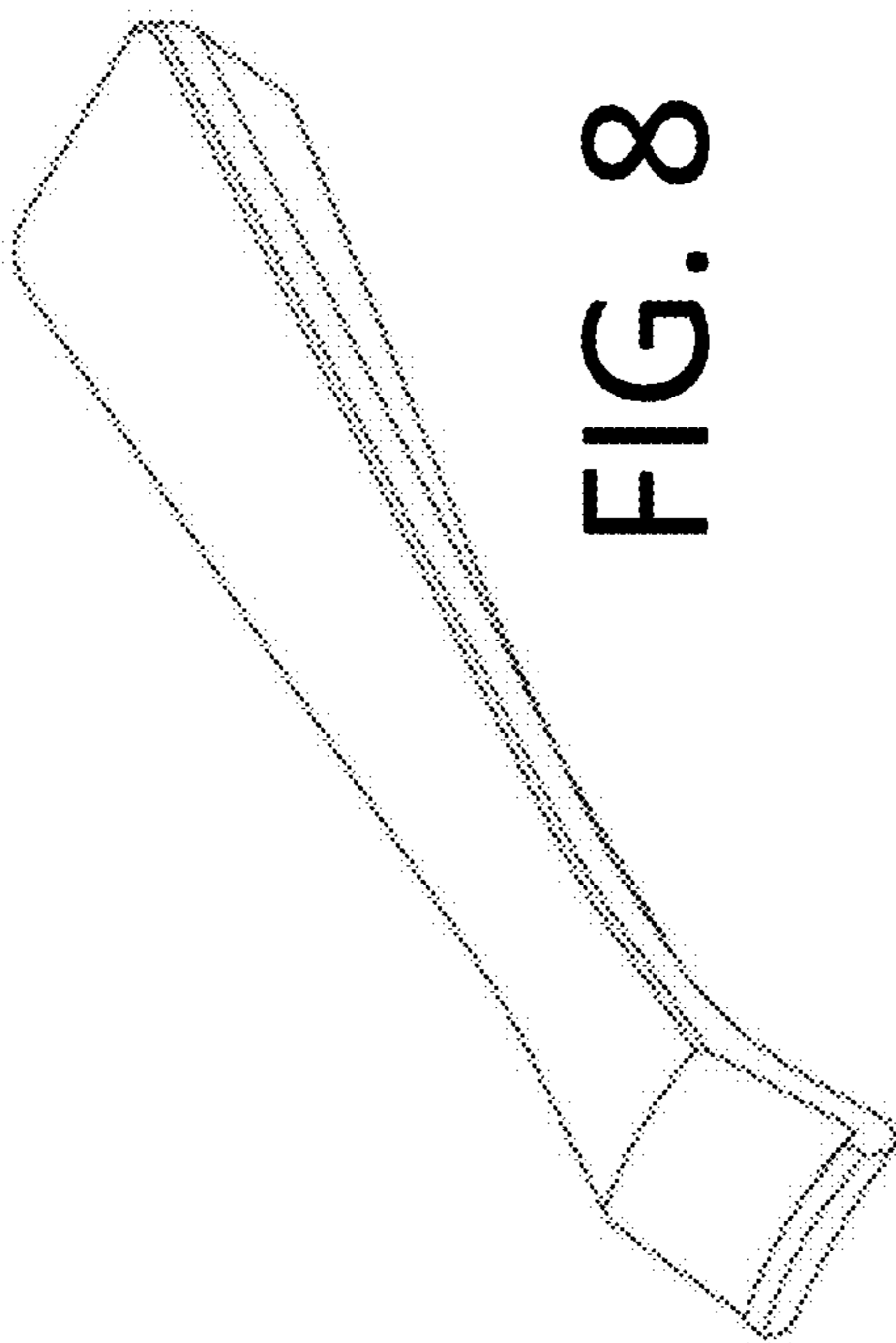

FIG. 8

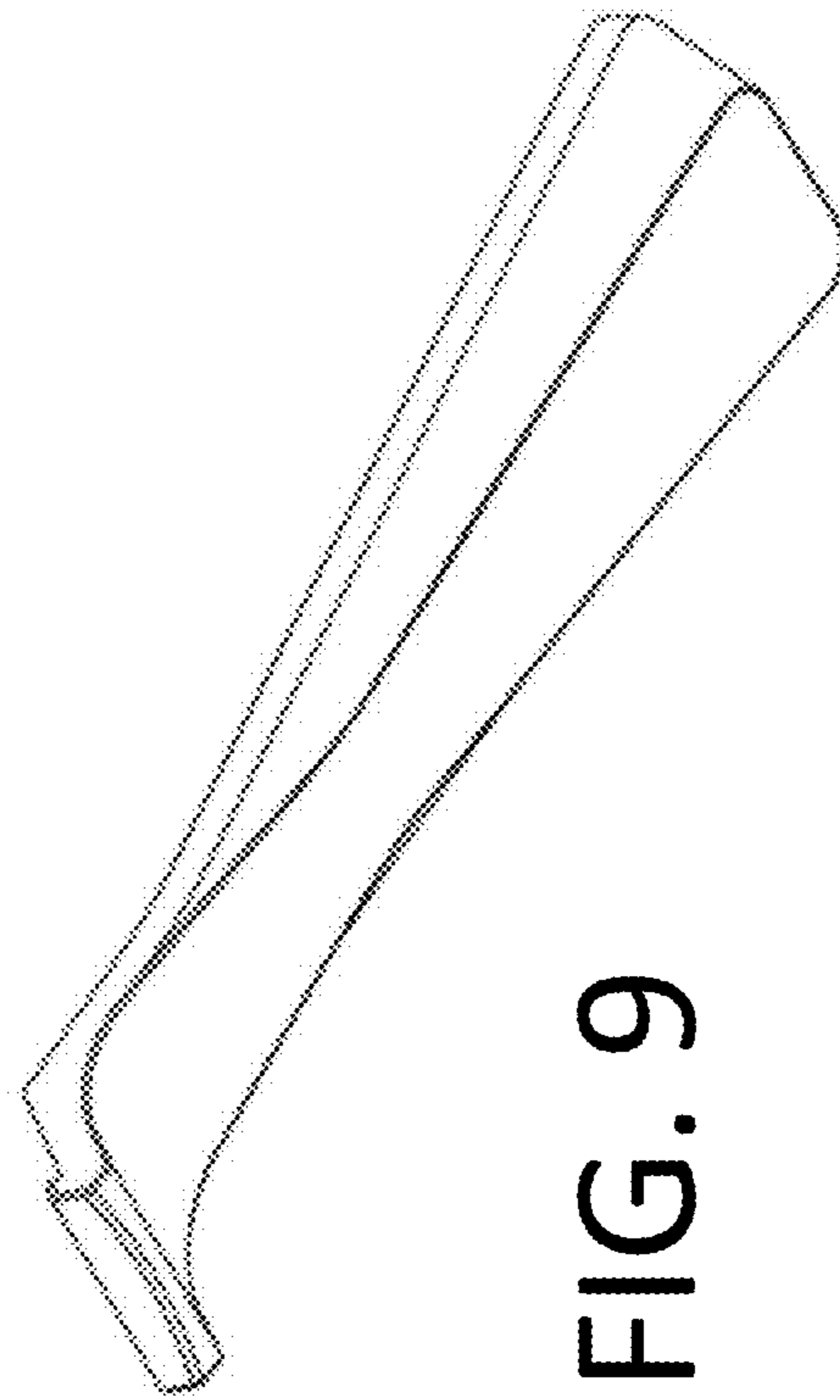

FIG. 9

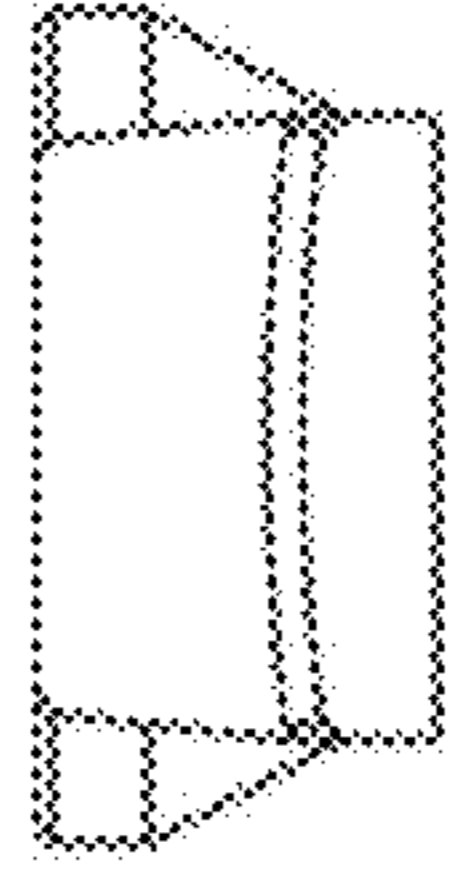

FIG. 10

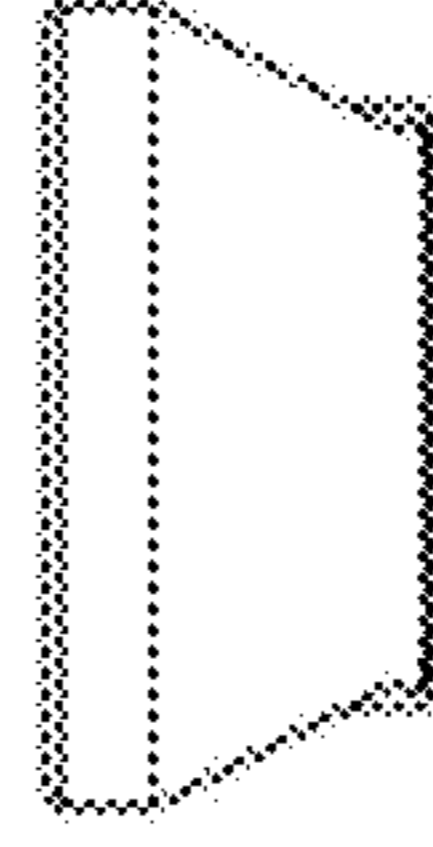

FIG. 11

FIG. 12

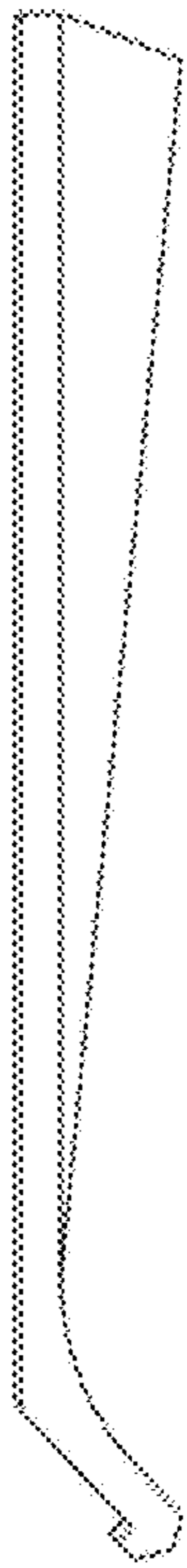

FIG. 13

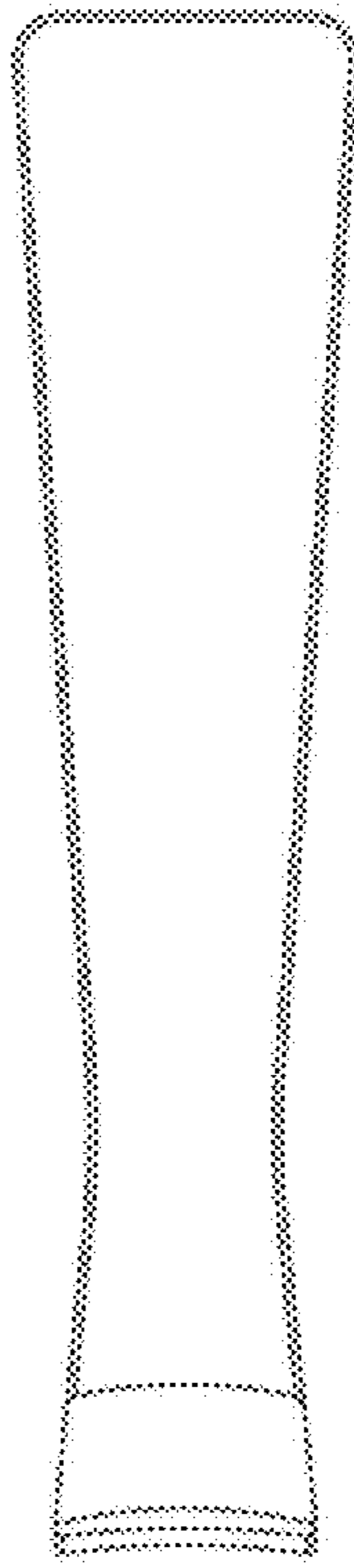
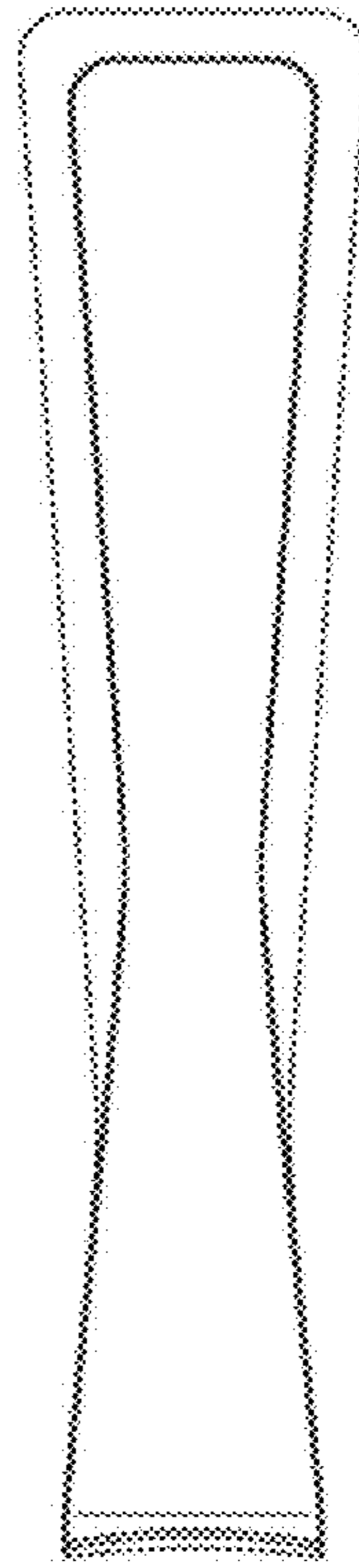

FIG. 14



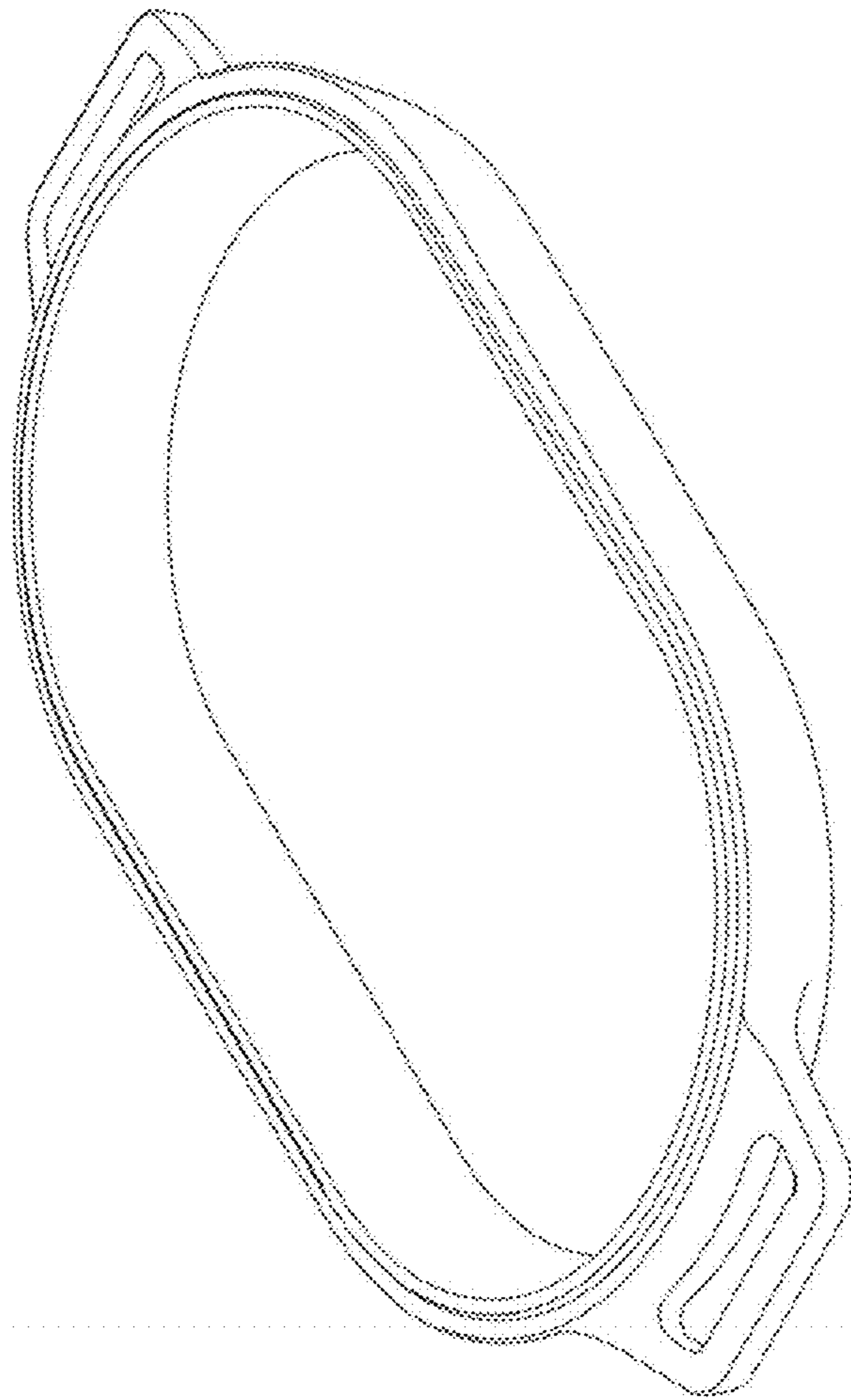

FIG. 15

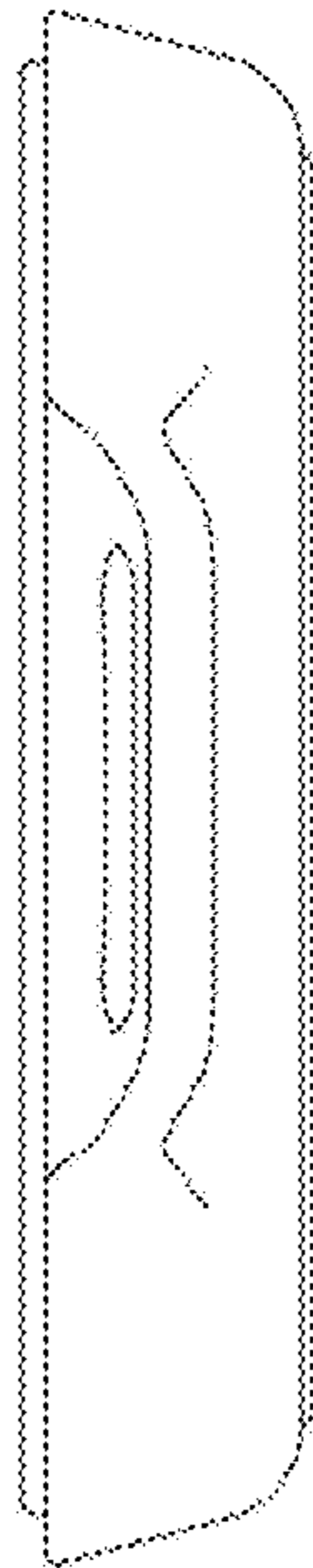

FIG. 16

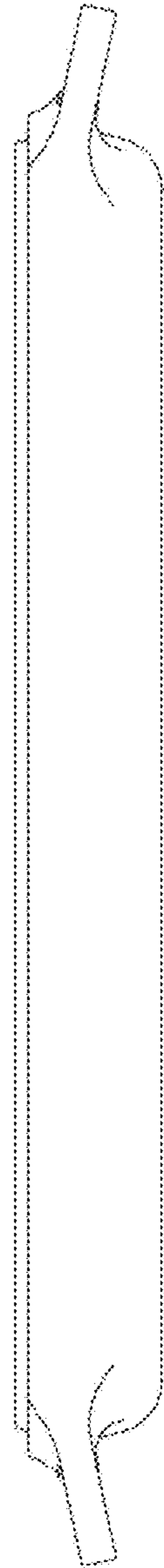

FIG. 17

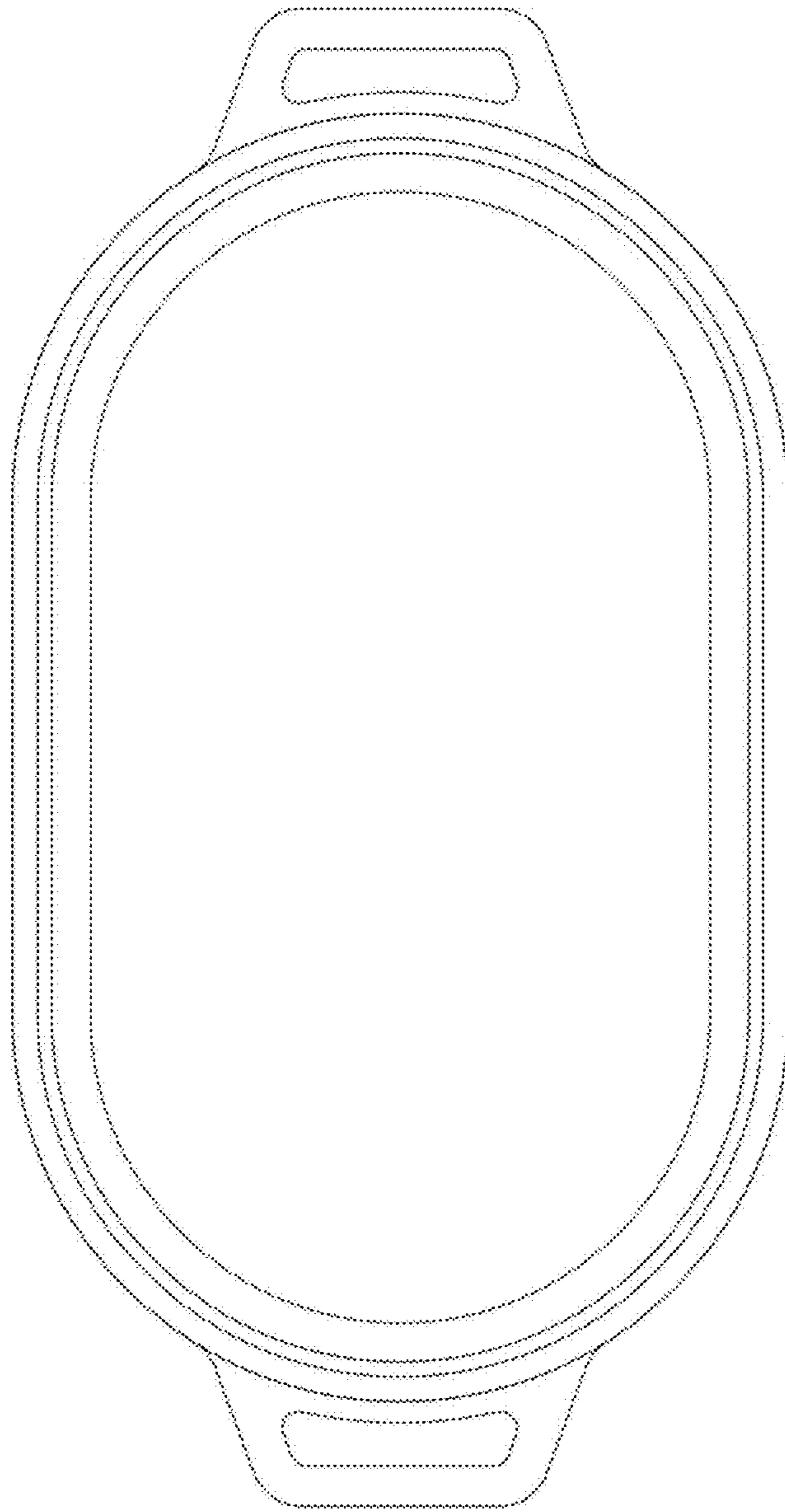

FIG. 18

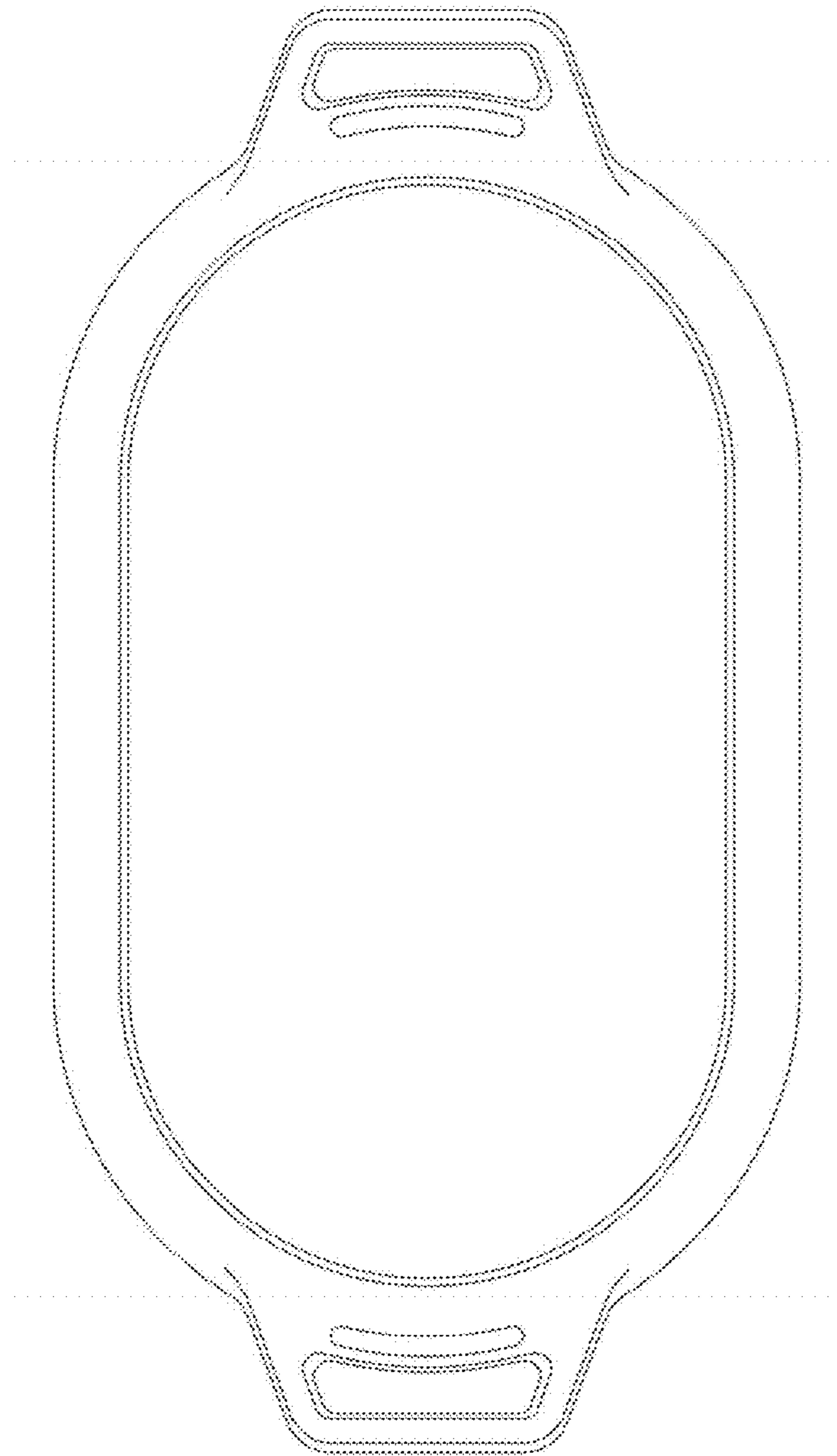

FIG. 19

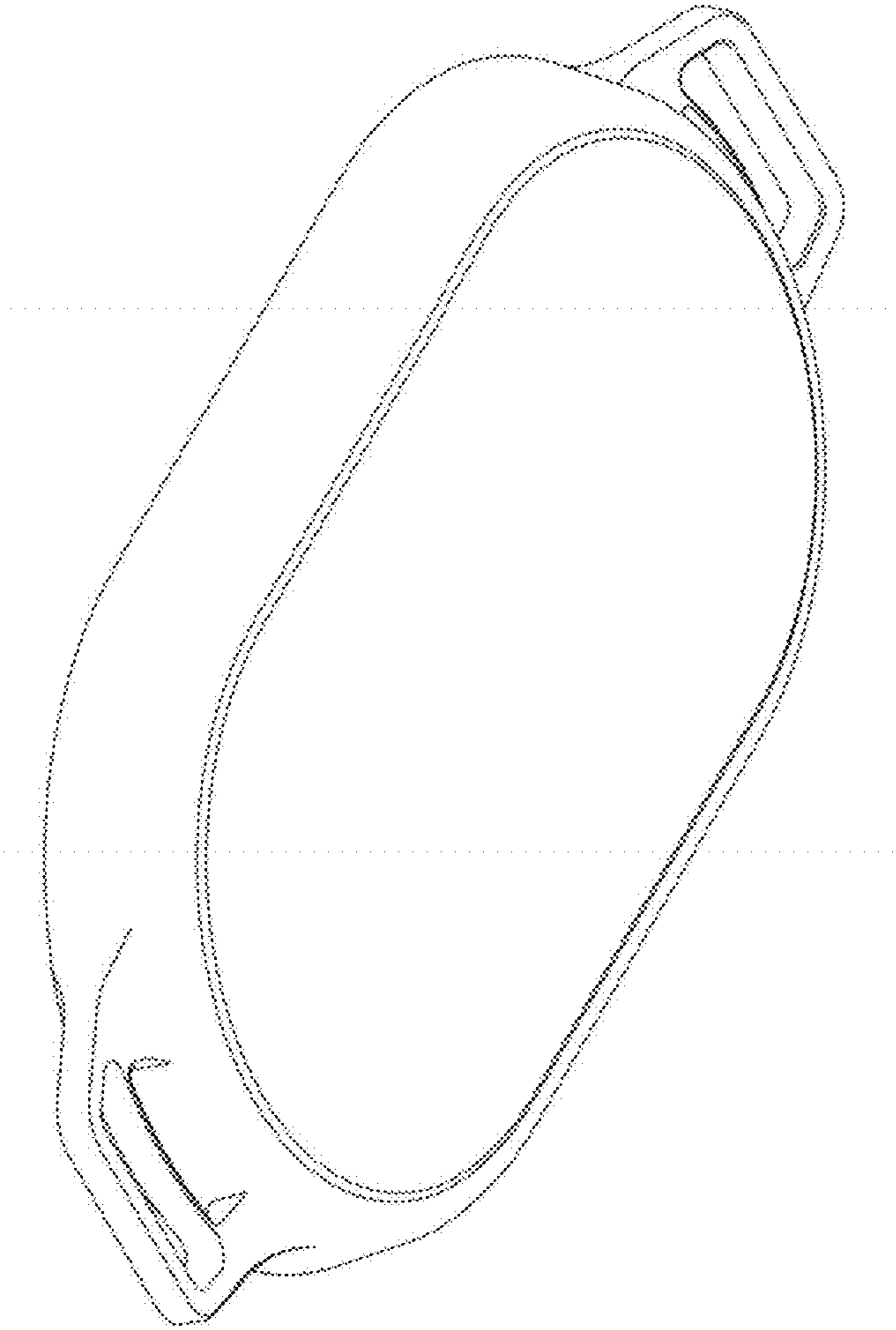

FIG. 20